



Features

- Spacious design accommodates up to two bathers.
- Corner layout minimizes footprint without compromising bathing area.
- Molded lumbar support and armrests offer extra comfort while bathing.
- Integral faucet deck.

Material

- Acrylic

Installation

- Drop-in

Additional Hydrotherapy Options

- Soaking Bath - 1155-0
- Whirlpool - 1154-0
- Whirlpool + heater - 1154-H

Recommended Products/Accessories

K-1491 Bath/Whirlpool Pillow
K-1601 Bath/Whirlpool Footstop
K-7213 27" Cable Bath Drain
K-7214 27" Cable Bath Drain
K-11677 Bath Drain
K-24916 Wireless Music Kit
K-7259 Clearflo Bath Drain



Codes/Standards





CSA B45.5/IAPMO Z124
Greenguard UL 2818 - Gold

KOHLER® Plastic Baths and Receptors Lifetime Limited Warranty

See website for detailed warranty information.

Available Colors/Finishes

Color tiles intended for reference only.

Color	Code	Description
	0	White
	96	Biscuit
	47	Almond
	71	Seafoam Green

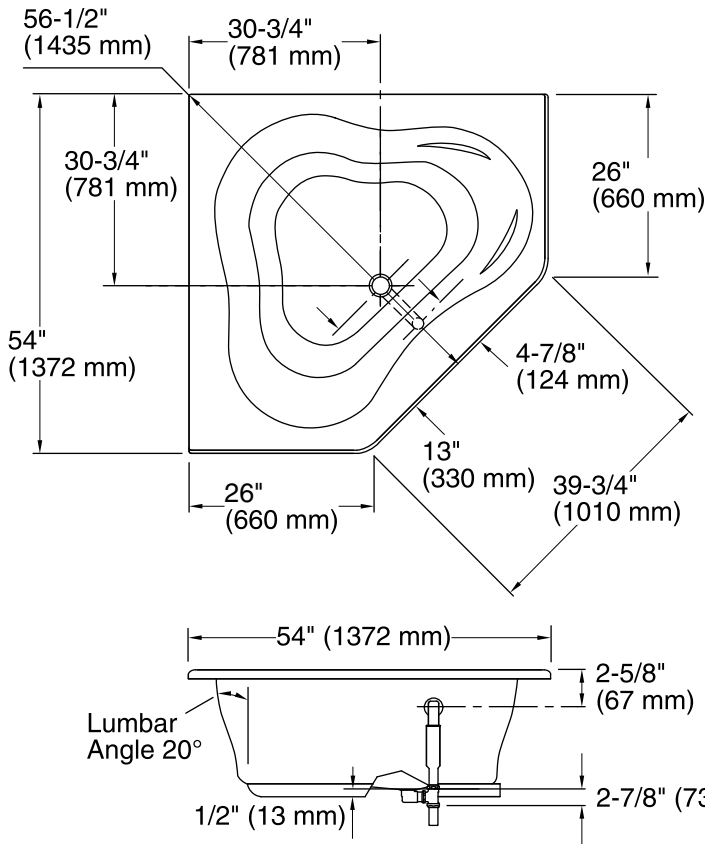

No change in measurements if connected with drain illustrated. (K-11677)

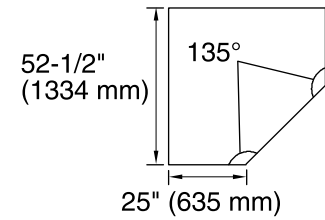

Drop-in Cut-out Detail

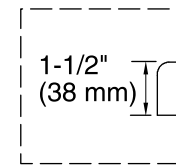

Drop-in Rim Detail

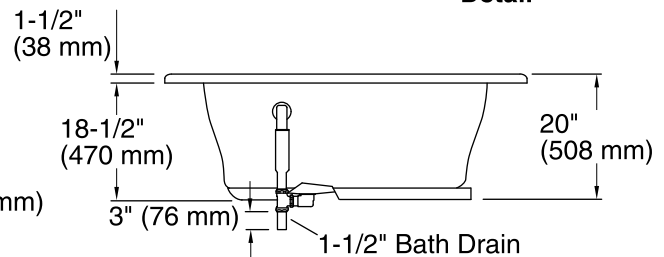

Technical Information

All product dimensions are nominal.

Installation:	Drop-in, Corner
Drain location:	Center
Basin area, bottom:	44" x 36" (1118 mm x 914 mm)
Basin area, top:	56" x 43" (1422 mm x 1092 mm)
Weight:	51 lbs (23.1 kg)
Minimum floor load:	35 lbs/ft ² (170.9 kg/m ²)
Water depth:	15" (381 mm)
Water capacity:	76 gal (287.7 L)

Notes

Measure your actual product for rough-in details. Install this product according to the installation instructions.

The hot water supply should be 70% of the capacity of the bath or greater. Installations will vary.