



Features

- Single-speed whirlpool offers performance and value, with 8 fully adjustable jets.
- Hydromassage flow and direction can be controlled at each jet.
- Built-in heater.
- Comfort Depth® design offers a convenient 19-inch step-over height while retaining the same depth as a standard 21-inch bath.
- Molded lumbar support offers extra comfort while bathing.
- Slotted overflow allows for deep soaking.
- Textured bottom surface
- Coordinates with other products in the Archer collection.

Material

- Acrylic

Hydrotherapy

- Whirlpool

Installation

- Drop-in

Additional Hydrotherapy Options

- Soaking Bath - K-1123-0
- Soaking Bath + Bask heated surface - K-1123-W1
- BubbleMassage air bath - K-1122-G
- BubbleMassage air bath + Bask heated surface - K-1122-GW
- VibrAcoustic - K-1122-VB
- VibrAcoustic + Bask heated surface - K-1122-VBW
- Whirlpool - K-1122-0
- Whirlpool + heater - K-1122-H
- Whirlpool + Bask heated surface - K-1122-W1
- Whirlpool + BubbleMassage air bath - K-1122-XHG

Required Products/Accessories

K-7271 Brass Slotted Overflow Bath Drain

or

K-7272 PVC Slotted Overflow Bath Drain

Recommended Products/Accessories

K-24916 Wireless Music Kit



ADA

Codes/Standards

ASME A112.19.7/CSA B45.10

CSA B45.5/IAPMO Z124

UL 1795

Greenguard UL 2818 - Gold

ADA

ICC/ANSI A117.1

KOHLER® Plastic Baths and Receptors

Lifetime Limited Warranty









KOHLER® Hydrotherapy Components

Five-Year Limited Warranty

See website for detailed warranty information.

Available Colors/Finishes

Color tiles intended for reference only.

| Color | Code | Description |
|--|------|---------------|
|  | 0 | White |
|  | 96 | Biscuit |
|  | 47 | Almond |
|  | NY | Dune |
|  | 95 | Ice™ Grey |
|  | G9 | Sandbar |
|  | 33 | Mexican Sand™ |
|  | K4 | Cashmere |

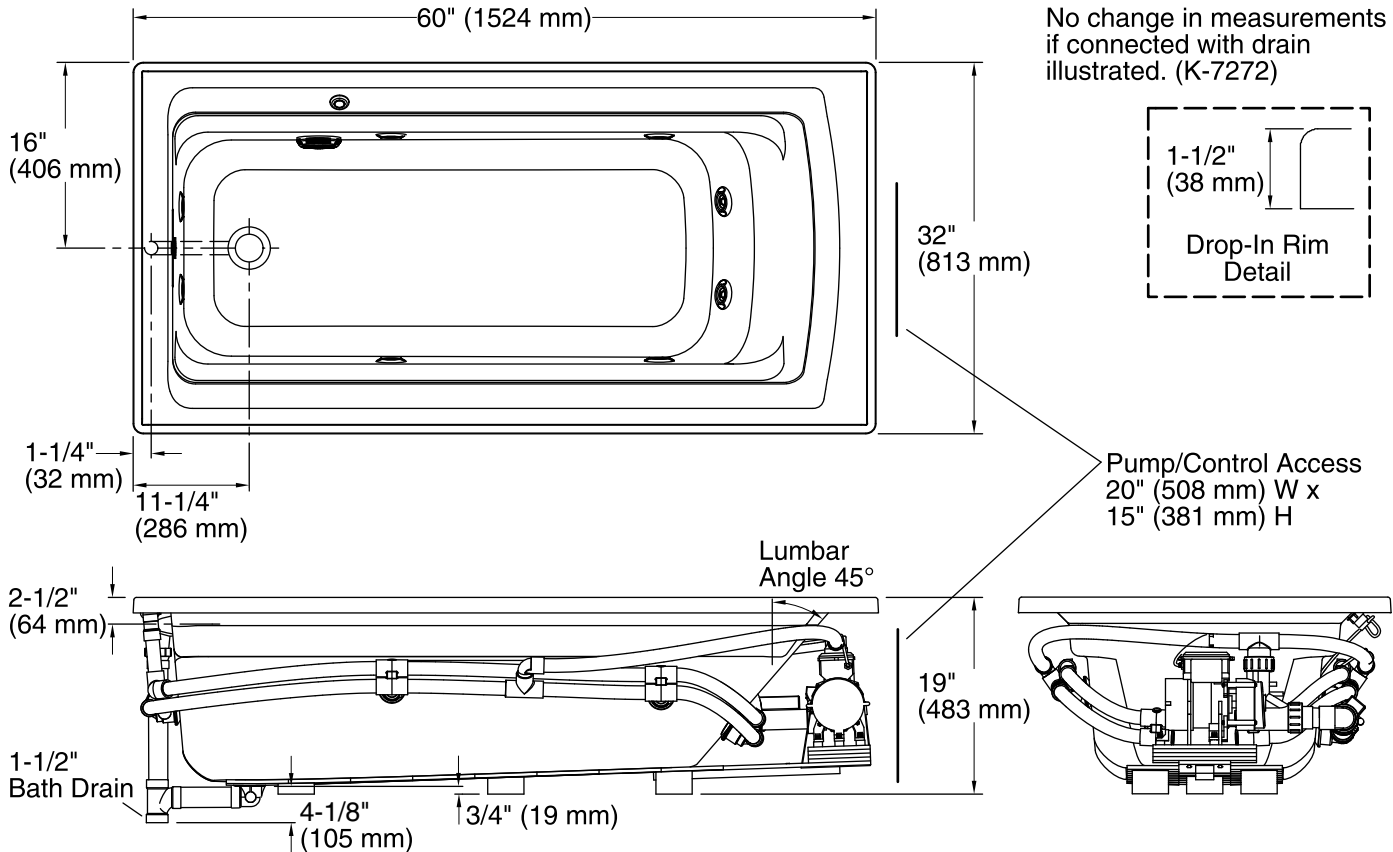

Required Electrical Service

Two dedicated circuits required, protected with Class A Ground-Fault Circuit-Interrupter (GFCI). Outside North America, this device may be known as a Residual Current Device (RCD).

| | |
|---------|--------------------|
| Pump: | 120 V, 15 A, 60 Hz |
| Heater: | 120 V, 15 A, 60 Hz |

Technical Information

All product dimensions are nominal.

| | |
|------------------------------|---|
| Installation: | Drop-in |
| Drain location: | End |
| Basin area, bottom: | 45-1/8" x 19-11/16" (1146 mm x 500 mm) |
| Basin area, top: | 52-3/4" x 25-5/16" (1340 mm x 643 mm) |
| Weight: | 110 lbs (49.9 kg) |
| Minimum floor load: | 46 lbs/ft ² (224.6 kg/m ²) |
| Water depth: | 15" (381 mm) |
| Water capacity: | 58 gal (219.6 L) |
| Cutout: | Drop-in, 58-1/2" x 30-1/2" (1486 mm x 775 mm) |
| Electrical component rating: | Pump: 120 V, 7 A, 60 Hz Heater: 120 V, 12.5 A, 60 Hz, 1500 W |
| Pump speed: | Single |

Notes

Measure your actual product for rough-in details. Install this product according to the installation instructions.

The hot water supply should be 70% of the capacity of the bath or greater. Installations will vary.

Provide one grounded electrical outlet within 24" (610 mm) of each component.

This product is designed for drop-in installation only. It is not suited for use in a three-wall alcove with an overhead shower.

ADA compliant when installed to the specific requirements of these regulations.