

QuickNet™ Fiber Cabling in the Data Center

Your network supports the critical data, voice, video, and security applications required to drive your business. QuickNet™ Fiber Cabling System simplifies the delivery of network services by providing reliable infrastructure components assembled and tested in a factory-controlled environment. An end-to-end cabling system is an ideal solution for data centers especially when time for traditional cable installation and termination is limited. QuickNet™ Fiber Cabling System components are terminated, tested and configured to fit the application, offering quick, plug-in deployment for trouble free network performance.

With the benefits of quick network deployment, assured performance, quality, and easy redeployment, the Panduit® QuickNet™ Fiber Cabling System is the perfect infrastructure solution for today's data centers.



PANDUIT®

infrastructure for a connected world

APPLICATION GUIDE

Quick Reference

QuickNet™ Fiber Cabling Systems	2
How to Use QuickNet™ Fiber Cabling Systems	3
QuickNet™ Fiber Cable Assembly Configurations	7
10G to 4G Migration	8
How to Configure QuickNet™ Fiber Cable Assemblies	9
Reach Table	11
Guide for Measuring QuickNet™ Fiber Cable Assembly Lengths	12
QuickNet™ Part Numbers	14
Selecting Fiber Optic Cassettes to support your QuickNet™ Fiber Cabling System	20
QuickNet™ Fiber Accessory Part Numbers	22

QuickNet™ Fiber Cabling Systems

QuickNet™ Fiber Cabling Systems are available in a range of configurations and meet the unique needs of data center projects of any scale.

This guide covers common considerations for using QuickNet™ Fiber Cabling Systems:

- Applications in the data center
- QuickNet™ Fiber Termination options and common configurations
- Specifying options, measuring for lengths and selecting QuickNet™ Fiber part numbers



QuickNet™ Fiber Applications in the Data Center

QuickNet™ products can be used for a wide variety of permanent link needs that are common in data center architectures such as Middle of Row (MoR) or End of Row (EoR) configurations, shown in Figure 1.

Figure 1 – Data Center Applications

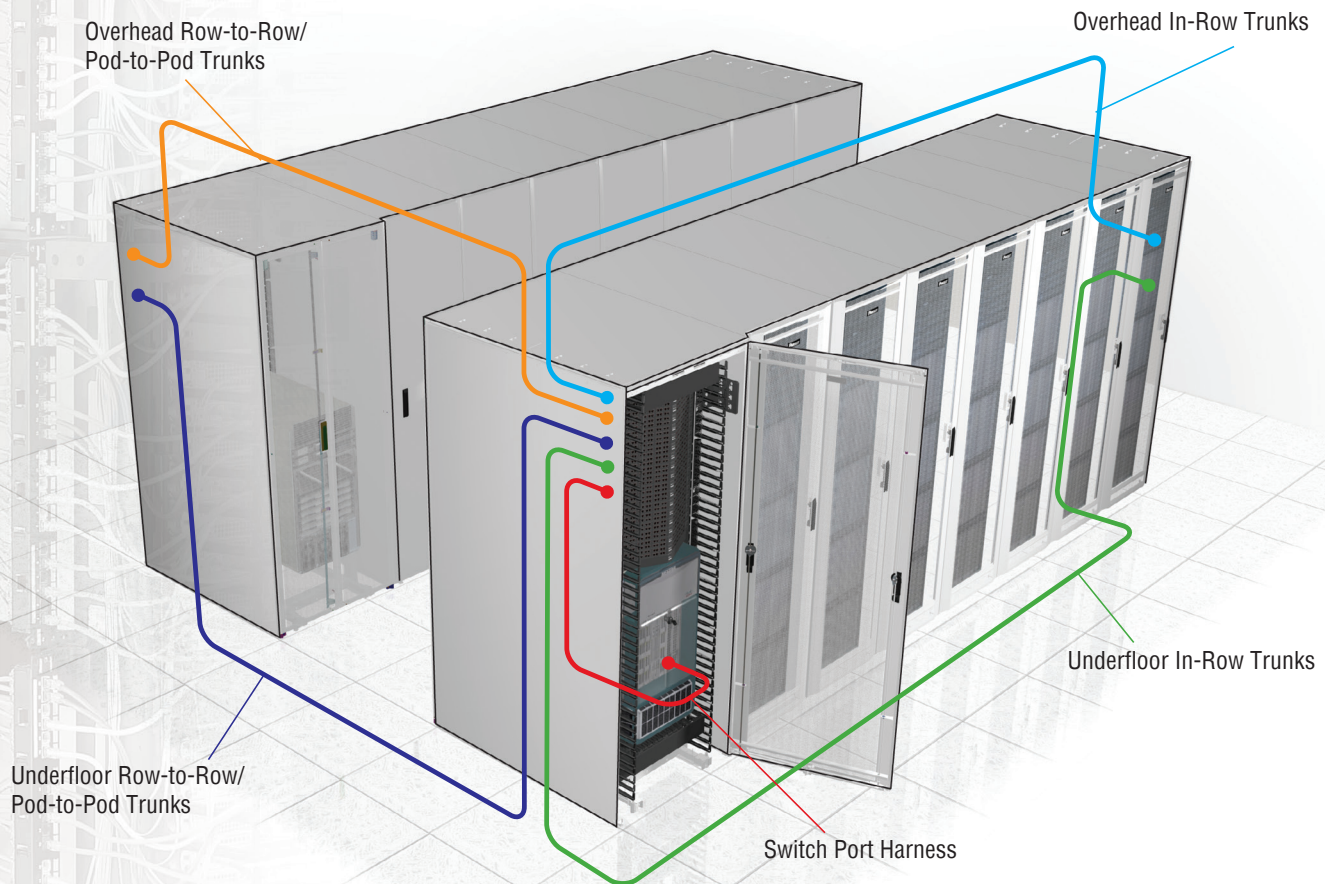

How to Use QuickNet™ Fiber Cable Assemblies

The following sections illustrate and describe in greater detail how QuickNet™ Fiber Trunks, Interconnects, Harnesses, and Patch Cords, Cassettes and Patch Panels, are used in common data center cabling configurations.

Two-Connector Interconnect

In this configuration, a permanent link is installed between QuickNet™ Patch Panels in the switch/network cabinet and the server or storage cabinets. The most common, flexible and upgradeable QuickNet™ Fiber solution is shown in Figure 2, below.

Figure 2 – Two-Connector Channel

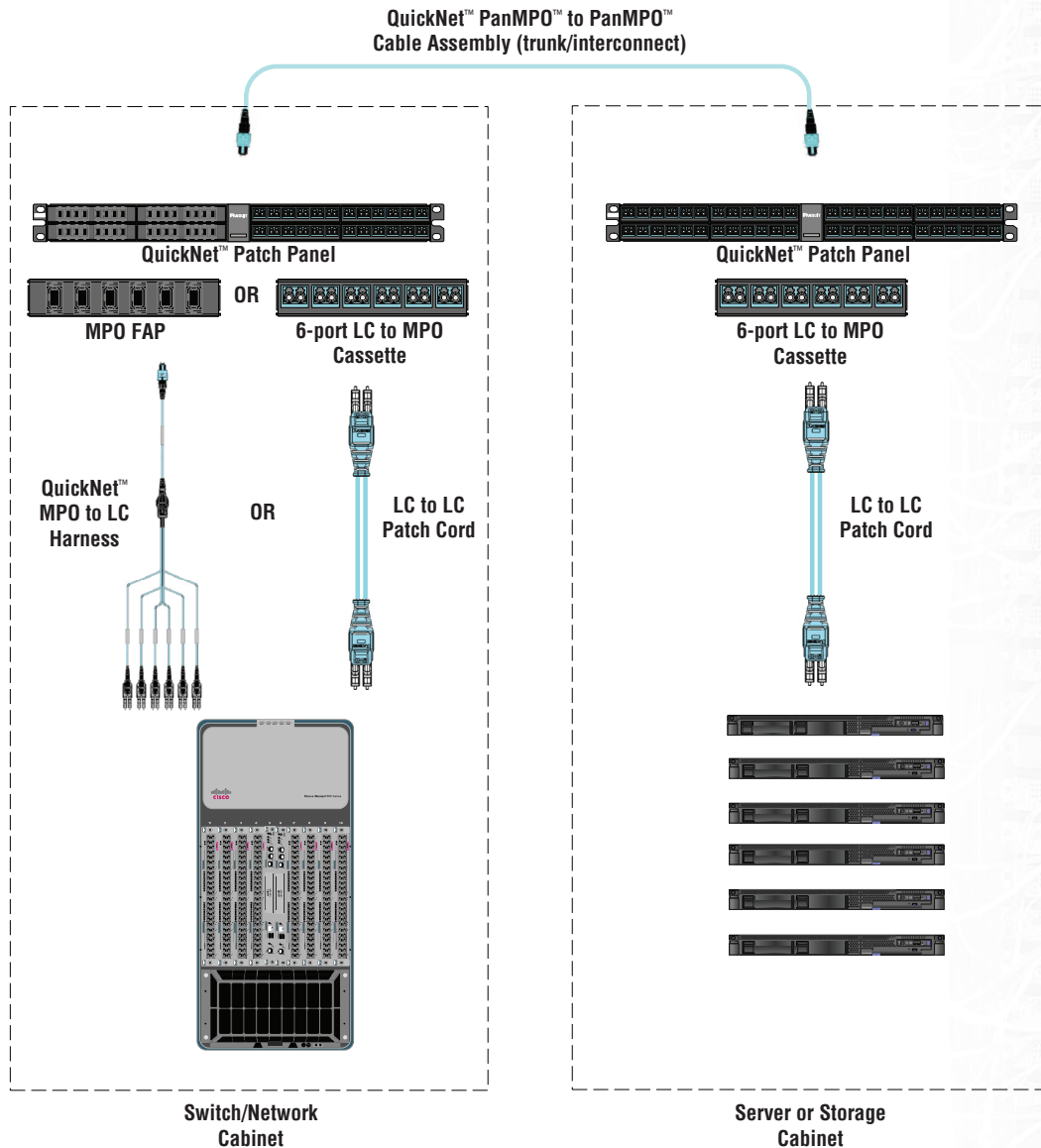

Four-Connector Cross Connect

In this configuration, permanent links are installed between QuickNet™ Patch Panels in the switch/network cabinet and server or storage cabinets and a common cross connect cabinet or rack. In this scenario, any fiber from any switch port or server uplink can be routed to anywhere within the datacenter. This option allows for easy moves, adds, or changes. The most common, flexible, and upgradeable QuickNet™ Fiber solution is shown in Figure 3, below.

Figure 3 – Four-Connector Channel with Cross Connect

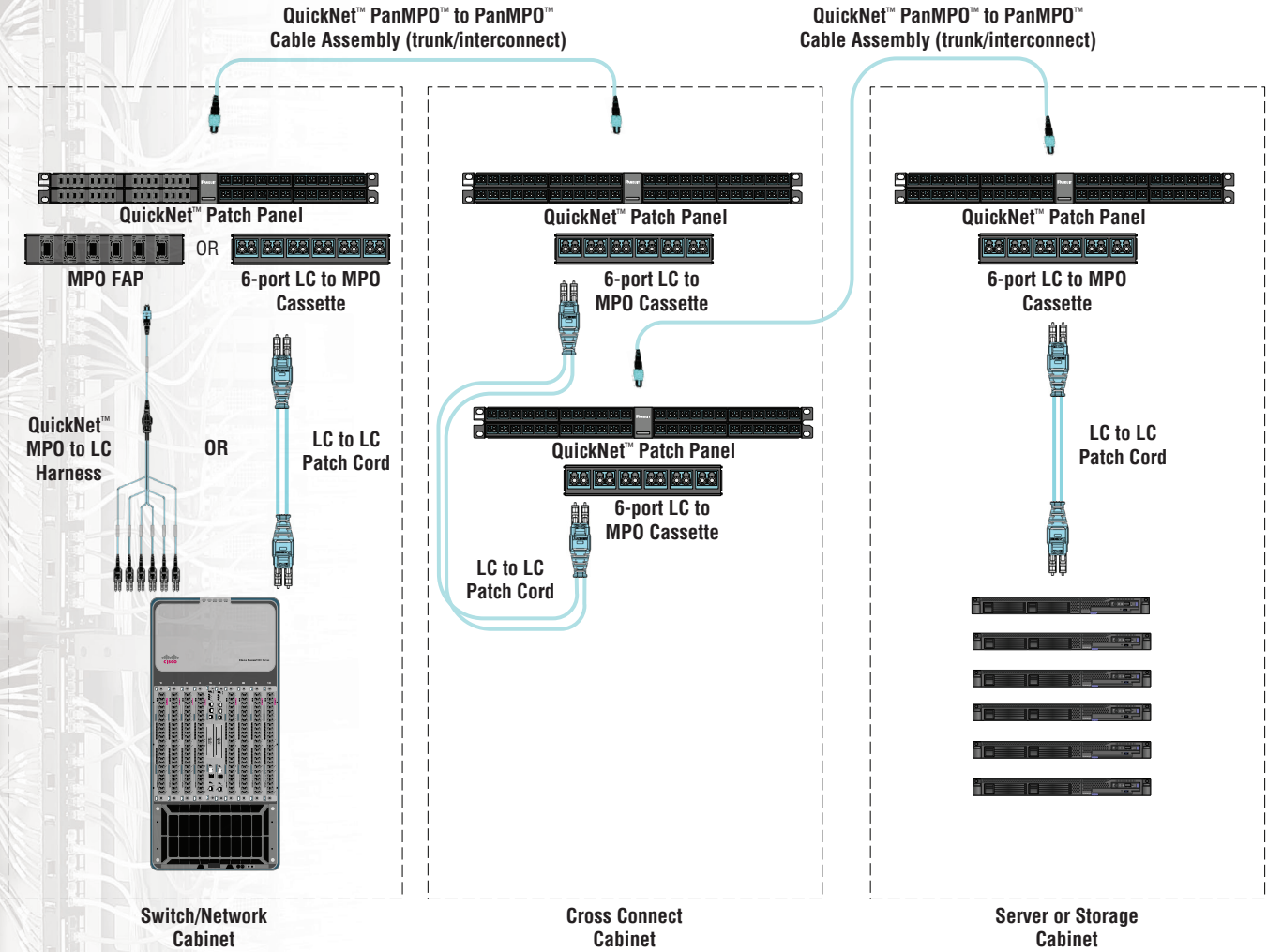

Switch Port Equipment Harnesses

Switch port equipment harnesses are utilized in the switching area of the data center and to consolidate cabling. The LC to MPO harnesses connect six (6) or four (4) (depending on the switch blade layout), LC transceivers in the switch to a single MPO connector in an adapter panel installed in the switch cabinet to within 15m of the switch cabinet. This allows for consolidation of the switch ports into a single MPO connector. Panduit switch port equipment harnesses come in three different breakout arrangements shown below in Figure 4. Figure 5 illustrates the application.

Figure 4 – Harness Configurations

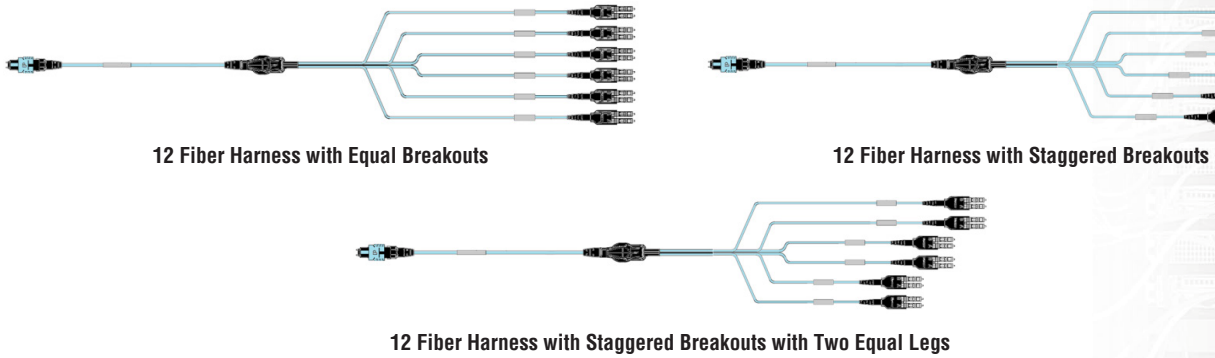
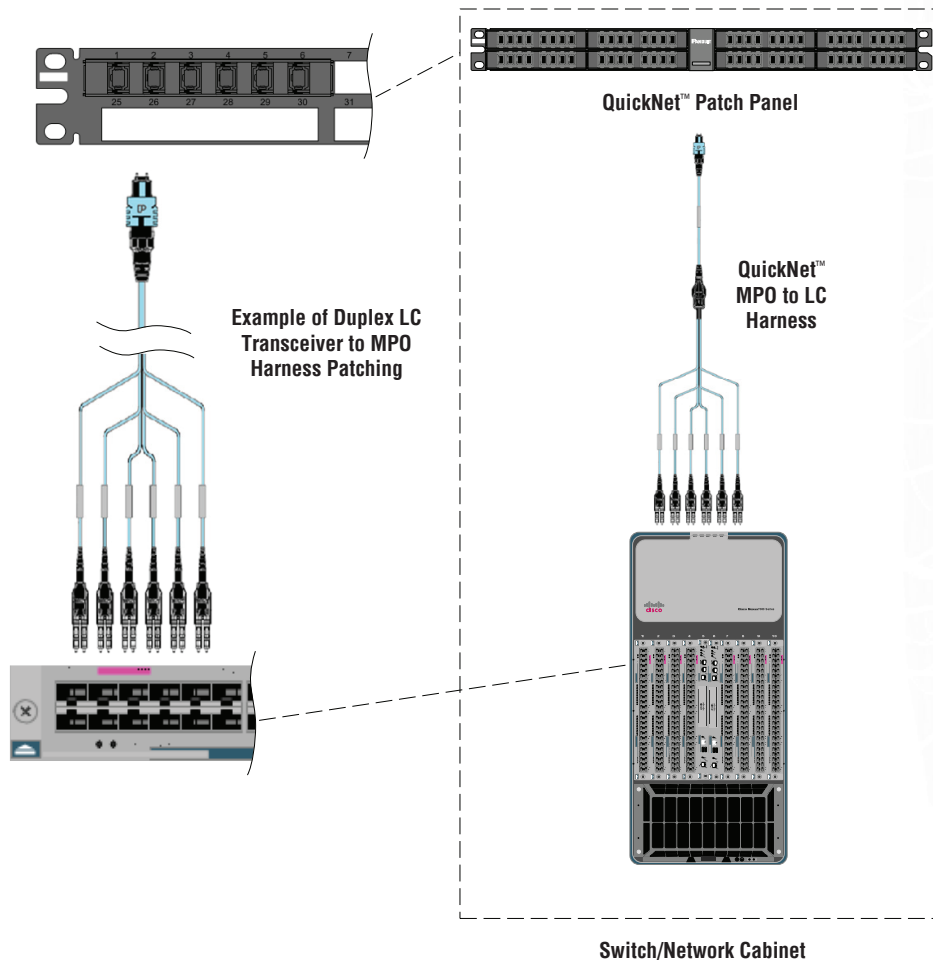

Figure 5 – Switch Port Equipment Harnesses



HDQ Series High Density Cassettes

The QuickNet™ HDQ Series High Density Fiber Optic Cassettes can be used in high density network applications for cross connects to assist with switch port replication. These cassettes mirror 32-port and 48-port Cisco^ blades and 32-port, 48-port and 64-port Brocade^^ blades as shown in Figure 6. These give the end user (at a cross connect area) the ability to visualize the blade port location when conducting moves, adds, or changes. Panduit also offers generic 48-port and 72-port HDQ cassettes.

Figure 6 – HDQ Example

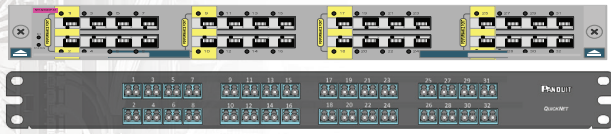

Cisco^ 32-Port Blade (top) and Corresponding Panduit Cassette (bottom)
F1RC**-6412-10S



Cisco^ 48-Port Blade (top) and Corresponding Panduit Cassette (bottom)
F1RC**-9612-10S

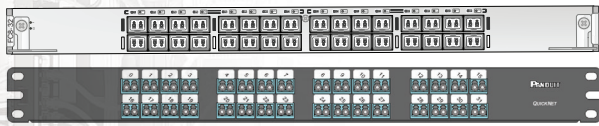

Brocade^^ 32-Port Blade (top) and Corresponding Panduit Cassette (bottom)
F1RB**-6408-10S

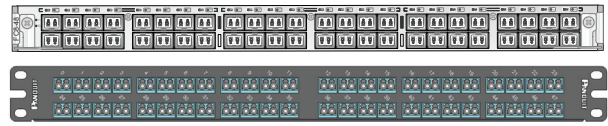

Brocade^^ 48-Port Blade (top) and Corresponding Panduit Cassette (bottom)
F1RB**-9608-10S

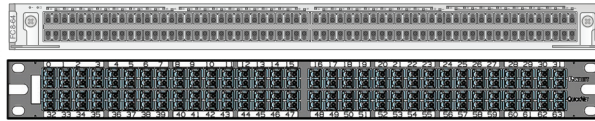

Brocade^^ 64-Port Blade (top) and Corresponding Panduit Cassette (bottom)
F1RB**-1B08-10S

** = Performance and fiber type

HDQ Series High Density Cassettes

QuickNet™ PanMPO™ to PanMPO™ Cable Assembly (Trunk/Interconnect)

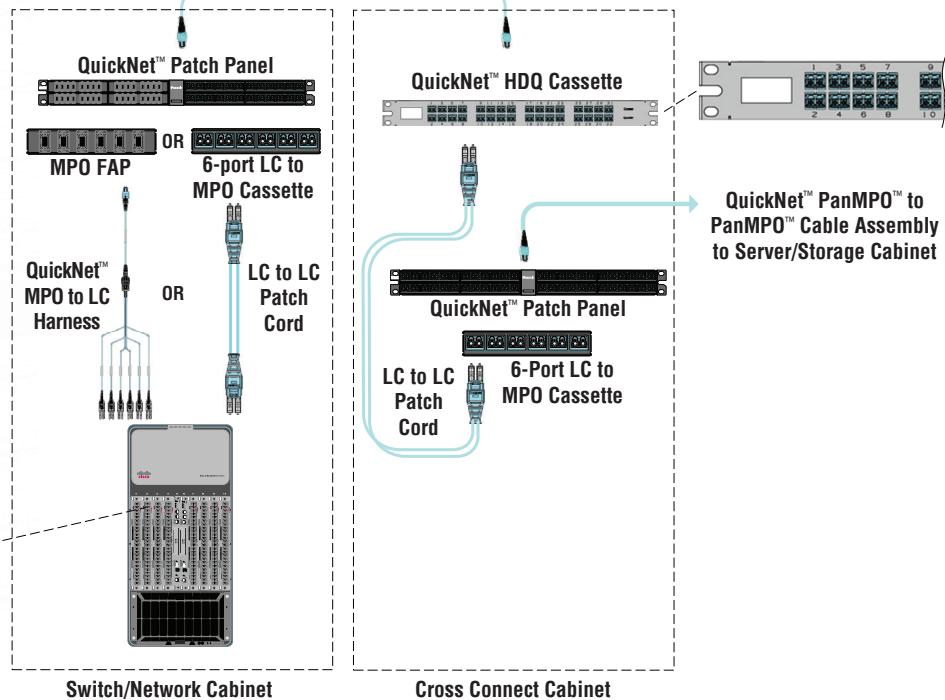

^Cisco and Cisco Systems are registered trademarks of Cisco Technology, Inc.
^^Brocade is a registered trademark of Brocade Communications Systems, Inc.

QuickNet™ Fiber Cable Assembly Options

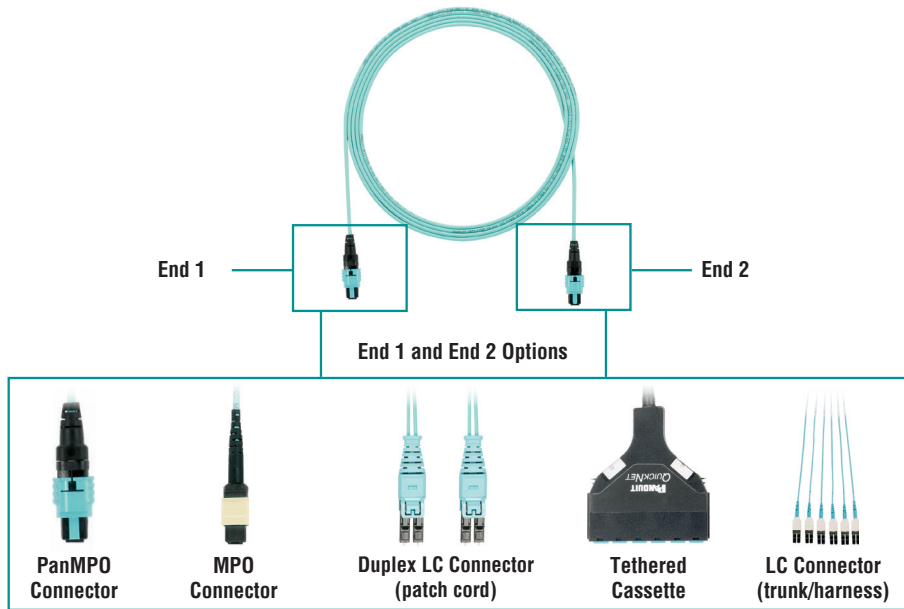

PanMPO Cable Assemblies

- Easily convert between male and female gender and between key-up and key-down polarity for 10G to 40G Ethernet installation
- Connector changes are made in the field as needed
- Available on trunks, harnesses and interconnects

Duplex LC to Duplex LC Patch Cord

- Patch cord with duplex LC connectors on both ends
- Typically used in cross-connect and as equipment patch cords in data centers
- Connect to pre-terminated cassettes in main, horizontal, and equipment distribution

MPO to MPO Trunks/Interconnect

- Trunk or interconnect fiber cable with 12-fiber MPO connector(s) or LC connectors on each end
- Trunks offer greater mechanical protection (3x crush) than interconnects and are built with pulling eye. Preferred for lengths >30m/100 ft.
- Typically used in cabinet-to-cabinet permanent backbone links
- Installs into QuickNet™ Fiber Adapter Panels (FAP) or cassettes

MPO to LC Harness

- Harness cable with 12-fiber or 8-fiber LC connector(s) on one end and one MPO connector on the other end
- Typically used for connectivity between the switch in horizontal cabling
- Installs into QuickNet™ MPO Patch Panels on one end and switch ports on the other end

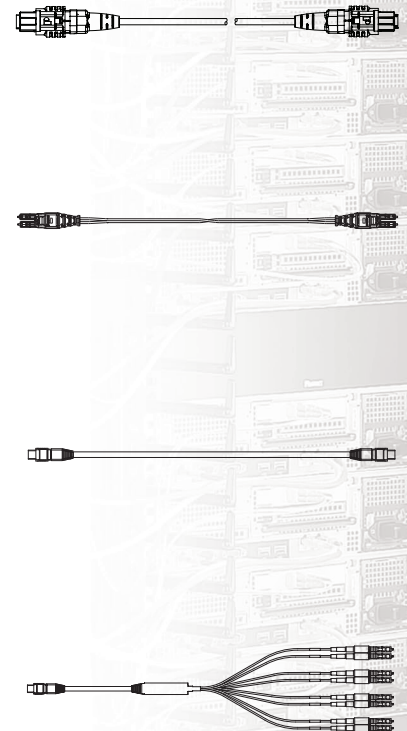

QuickNet™ Fiber Cable Assembly Configurations (continued)

Cassette to Cassette Trunk

- Cassette of either 12 LC or 4, 6, 8 MPO connectors on each end
- Typically used for intra-row connectivity
- Factory tested as permanent link (does not require re-test in the field)

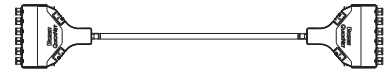

Cassette to MPO Trunk

- Cassette of either 12 LC or 4, 6, 8 MPO connectors on one end to discrete connectors on the other end.
- Typically used for inter-row connectivity

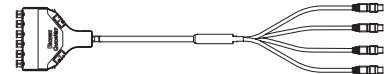

Cassette to LC Trunk

- Cassette of either 12 LC or 4, 6, 8 MPO connectors on one end to discrete connectors on the other end.
- Typically used for inter-row connectivity

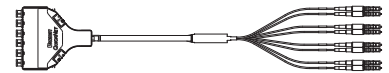

10G to 40G migration

PanMPO™ Connector makes 10G to 40G migration easy.
Discover how easy here: www.panduit.com/panmpo

10G Method A with PanMPO

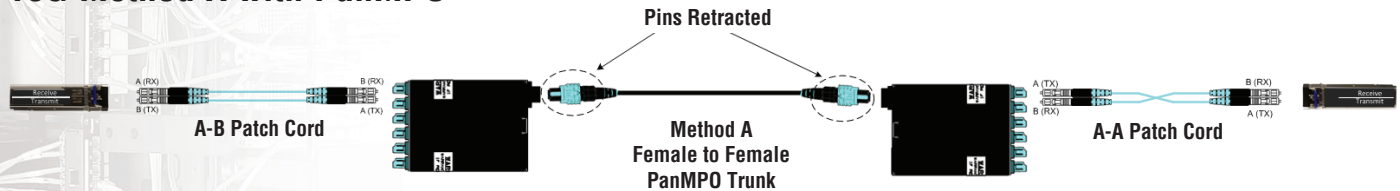

40G Method B with PanMPO

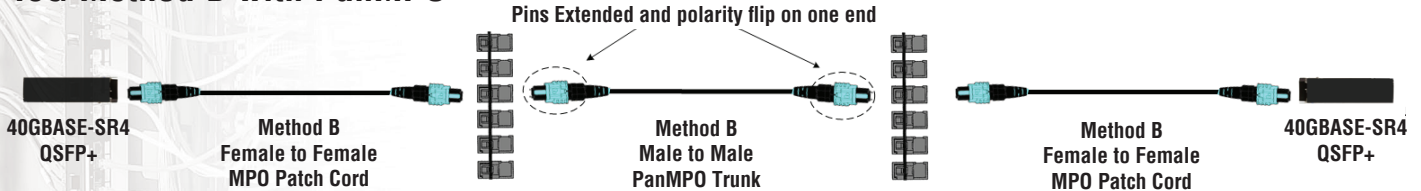

Panduit recommends the use of Method B polarity for 40G multimode parallel fiber solutions. Method B (Key Up to Key Up array connectivity) is widely used throughout the industry and is discussed in TIA-568-C.1. Method B array connectivity allows for the same equipment patch cords to be used whether the channel is comprised of the LC based 10GBASE-SR technology using array solutions in the horizontal cabling infrastructure or the MPO based 40GBASE-SR4 technology using array solutions throughout the infrastructure.

To assist with array polarity and gender, Panduit is offering the PanMPO which is a gender/polarity changeable MPO connector. PanMPO will allow for either male/female gender or key up/key down or key up/key up MPO trunk configurations.

How to Configure QuickNet™ Fiber Cable Assemblies

The QuickNet™ Fiber product family has a wide range of available configuration options from standard MPO to MPO cable assemblies to fully custom assemblies that are user-defined. In this section, each of the main configuration options for QuickNet™ Fiber are explained and typical considerations for data center applications are covered.

Fiber Type

The fiber type selected in the assembly indicates the maximum data rate that will be supported.

Cable choices:

- OS1/OS2 (Singlemode)
- OM3
- OM4

Laser optimized multimode fibers OM3, OM4 exceed domestic and international standards for optical fiber and support a diverse set of legacy and contemporary applications including Ethernet and Fibre Channel among many others. For 10GbE applications, the following link lengths are supported:

- OS1/OS2: 10km
- OM3: 300m
- OM4: 400m

Cable color defines fiber media type:

- OS1/OS2: Yellow
- OM3: Aqua
- OM4: Aqua

Note: Additional guidance on the supported link reaches for data center applications with various channel insertion losses is available at www.panduit.com.

Fiber Count

Fiber count choices:

Interconnects

- 12-fiber
- 24-fiber

Harnesses

- 8-fiber
- 8-fiber QSFP to SFP+
- 12-fiber

Trunks

- 12-fiber
- 24-fiber
- 48-fiber
- 72-fiber

Cable Flame Rating

Cable flame rating choices are:

- Low Smoke Zero Halogen (LSZH), tested to IEC 60332, 60754, and 610345
- Optical Fiber Non-Conductive Plenum (OFNP), tested to NFPA 262
- Optical Fiber Non-Conductive Riser (OFNR), tested to UL-1666

Low Smoke Zero Halogen (LSZH) rated cable is jacketed with compounds that emit limited smoke and no halogen when exposed to high heat sources. It is the preferred jacket in EMEA.

Plenum (OFNP) is jacketed with a fire-retardant plastic.

Riser (OFNR) cables contain no electrically conductive materials. These are used in a contained area, usually a vertical shaft.

Trunk Type and Terminations

Both ends of a QuickNet™ Fiber cable assembly include one of a range of factory termination options – each end can be different and are selected based upon the desired application of the trunk or harness within the data center.

Termination choices are:

- Duplex LC to Duplex LC
- PanMPO to PanMPO
- PanMPO to LC
- MPO to MPO
- MPO to LC
- Cassette to Cassette
- Cassette to MPO/Duplex LC

Insertion Loss is the amount of power lost at each mated pair of connectors. Standard maximum insertion loss per connector pair:

- Multimode PanMPO to PanMPO: 0.50dB
- Multimode MPO to MPO: 0.50dB
- Multimode LC to LC: 0.25dB
- Singlemode MPO to MPO: 0.75dB
- Singlemode LC to LC: 0.35dB

Optimized insertion loss per connector pair:

- Multimode PanMPO to PanMPO: 0.35dB
- Multimode MPO to MPO: 0.35dB
- Multimode LC to LC: 0.15dB

Assembly Options

Options include:

- No Pulling Eye
- Pulling eye on one end (as shown in Figure 8)
- Pulling eye on both ends

A pulling eye is a loop of braided sleeve material that is applied to one or both ends of the QuickNet™ Trunk Assembly, and is used to pull the cable in the pathways at deployment.

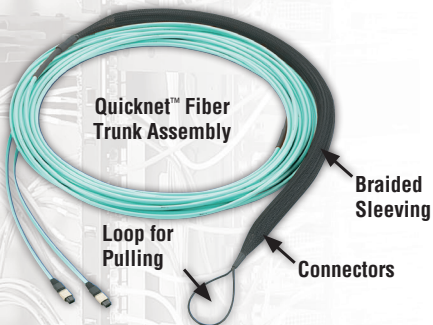

**Figure 8 –
Pulling Eye Option**

Labeling

All QuickNet™ Fiber Cable Assemblies have an assembly label on each end which includes the part number, length, and a serialized quality control number. Label example shown in Figure 9.



Figure 9 – Labels

Reach Table

Panduit® laser optimized OM3, OM4 multimode fibers meet domestic and international standards. Signature Core™ exceeds domestic and international standards for optical fiber. This includes TIA-492AAAB, TIA-492AAAC, TIA-492AAAD and IEC 60793-2-10 and support a diverse set of legacy and contemporary applications including Ethernet, Fibre Channel, Infiniband™ and FICON (Fiber Connection) among others.

Application	Connectivity Budget (dB)		
	1.5		
	Fiber Category		
	OM3	OM4	SigCore
	Maximum Channel Length (m)		
10 Gb/s Ethernet (10GBASE-SR)	300	400	550
40 and 100 Gb/s Ethernet (40/100GBASE-SR4/10)	100	125	165
4G Fibre Channel	380	400	500
8G Fibre Channel	150	190	250
16G Fibre Channel	100	125	200
Cisco 40G BiDi	100	135	200
100 Gb/s Ethernet (4x25) (100GBASE-SR4)	70	100	125

Note: Maximum channel lengths will increase or decrease based on higher or lower loss budgets.



Guide for Measuring QuickNet™ Fiber Cable Assembly Lengths

Proper measuring for QuickNet™ Fiber Cable Assembly lengths is straightforward but does require some detailed information about the data center layout. For the most accurate length measurements, it is best to work from layout drawings and know the specific equipment to be used, the cabinet dimensions, and the desired positions in the cabinets of patch panels and equipment.

The illustration below shows a typical data center link and the sections that must be considered to properly measure for QuickNet™ Fiber Cable Assembly lengths. This example shows an overhead in-row installation. For other configurations, adjust accordingly. (For example, with underfloor configurations, measure down from the panels to the pathway).

Recommended Steps for Measuring QuickNet™ Fiber Cable Assembly Lengths:

1. Calculate or measure the length of each section of the link.
 - a. Harness length: $A1 + A2$
 - b. Horizontal cable length: $B + C + D$
2. Round the total upward to the nearest foot to get the minimum QuickNet™ Fiber Cable Assembly length.

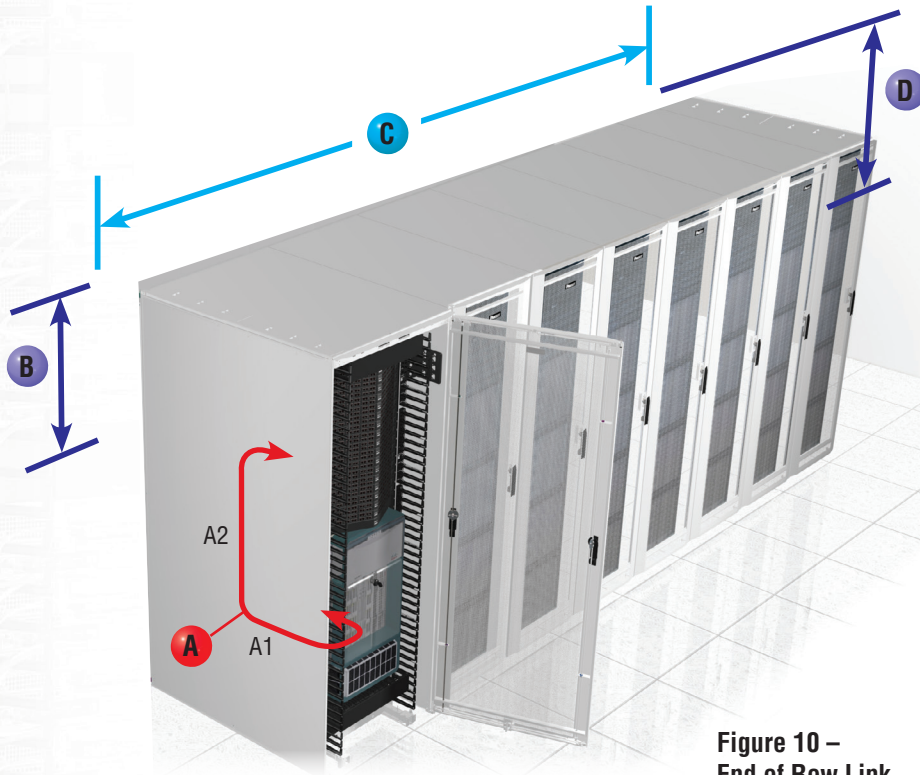

Figure 10 – End of Row Link

Link Sections and Guide for Measuring:

- A In-cabinet length:** The total length of the cable inside the cabinet ($A1 + A2$).
 - A1 – Horizontal distance from switch face to vertical manager – Panduit recommends 1m breakout or stagger to allow for cable routing and management.
 - A2 – Distance from vertical manager to patch panel in cabinet – this can vary depending upon where the patch panel is located within the cabinet.
- B Patch panel-to-pathway length:** The distance from the patch panel in cabinet to the cable pathway.
- C Length along pathway:** The total distance along the pathway between the cabinet entry/exit points.
- D Pathway-to-patch panel length:** Similar to B.

Length Measurement Example

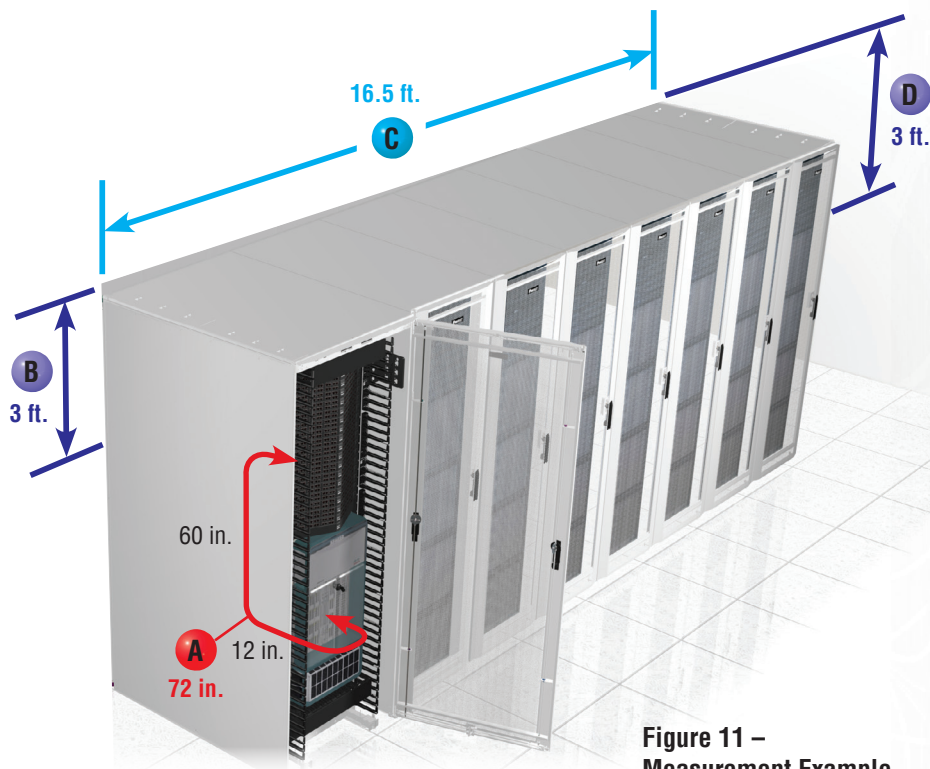

Figure 11 –
Measurement Example

Example: In-cabinet length: 72 in. (12 in. + 60 in.)

- A** A1 – Distance from switch plate to vertical manager = 12 in.
A2 – Distance from vertical manager to patch panel = 60 in.
- B** Patch panel-to-pathway length: 3 ft.
- C** Length along pathway: 16.5 ft. (assuming seven 24 in. wide server cabinets and cable exit on far side of 30 in. wide network cabinet = (7 x 2 ft.) + 30 in.)
- D** Pathway-to-patch panel length: 3 ft.

Total harness length = (12 in. + 60 in.) = 72 in. = **6 ft.**

Total horizontal cable length = (3 ft. + 16.5 ft. + 3 ft.) = 22.5 ft. = **23 ft.**

Tips for Measuring Lengths:

- The specified length of a QuickNet™ Fiber Cable Assembly is the distance as measured from the front of the connector on one end to the front of the connector on the other end. Other than a nominal manufacturing tolerance there is no additional length built into a QuickNet™ Fiber Cable Assembly.
- Remember to account for any turns or obstructions in the pathway that may lead to additional length needed (for example, ducting, support posts, etc.).
- Cable assembly bend radius limits must be taken into consideration, especially for multiple turns within cabinets or as the cable assembly transitions to or from the pathways, and may require additional length of the assembly.

QuickNet™ Part Numbers

QuickNet™ Fiber Cable Assemblies – Part Numbers

Opti-Core® Fiber Optic Patch Cords and Pigtails

Steps to Select:

- 1 Select Cable Options
- 2 Select Ends 1 and 2
- 3 Select Construction/Performance
- 4 Select Length

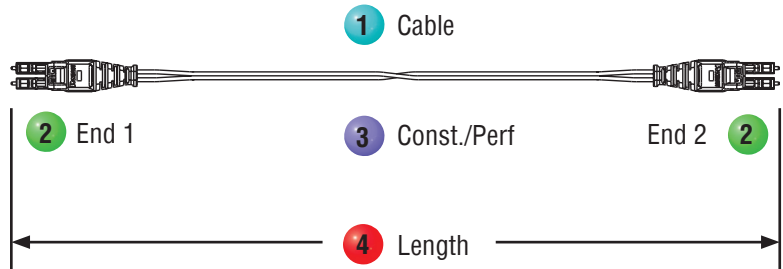

Fiber		Cable			End 1		End 2		Const./Perf	Other	Length			
Fiber	Fiber Count	Cable	Jacket	Connector	No Variant	Connector	No Variant		None	Unit	3-digit Length			
F	X	2	E	R	Q	1	Q	1	S	N	M	0	0	5

Fiber Type

9 = OS1/OS2 9/125µm
X = OM3 50/125µm
Z = OM4 50/125µm

Fiber Count

1 = 1-fibers
2 = 2-fibers

Cable Type

B = 900µm buffer (pigtail only)
E = 1.6mm (standard for LC)
3 = 3.0mm (standard for SC)

Jacket Type

L = Low Smoke Zero Halogen (LSZH)
R = Optical Fiber Nonconductive Riser (OFNR)
P = Optical Fiber Nonconductive Plenum (OFNP)

Connector Type End 1

1 = LC Simplex
3 = SC Simplex
A = SC-APC
L = LC duplex
Q = Push-Pull LC duplex
S = SC duplex

Connector Variant

1 = Push-Pull (LC duplex only)
N = No Variant

Connector Type End 2

1 = LC Simplex
3 = SC Simplex
A = SC-APC
L = LC duplex
N = None (pigtail)
Q = Push-Pull LC duplex
S = SC duplex

Performance/Polarity

S = Standard IL/Standard Polarity
O = Optimized IL/Standard Polarity

Connector Variant

1 = Push-Pull (LC duplex only)
N = No Variant

Length

1m to 50m (001-050)
1m increments

Unit of Length

M = Meters

Above part number **FX2ERQ1Q1SNM005**: Fiber, OM3 50/125µm 2-fiber 1.6mm riser, LC push-pull connector to LC push-pull connector, standard IL, 5m.

QuickNet™ Fiber Cable Assemblies – Part Numbers

QuickNet™ Round Interconnect Cable Assemblies

Steps to Select:

- 1 Select Cable Options
- 2 Select Ends 1 and 2
- 3 Select Construction/Performance
- 4 Select Length

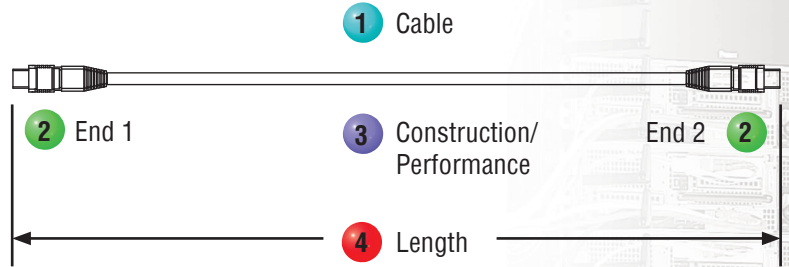

Fiber		Cable			End 1		End 2		Const./Perf	Other	Length			
Fiber	Count	Cable	Jacket	Connector	No Variant	Connector	No Variant		None	Unit	3-digit Length			
F	X	T	R	P	7	N	7	N	A	N	M	0	0	1

Fiber Type

9 = OS1/OS2 9/125µm
 X = OM3 50/125µm
 Z = OM4 50/125µm

Fiber Count

T = 12-fibers

Cable Type

R = 3.0mm round indoor

Jacket Type

L = Low Smoke Zero Halogen (LSZH)
 P = Optical Fiber Nonconductive Plenum (OFNP)

Connector Type End 1

5 = MPO female
 6 = MPO male
 7 = PanMPO™ female*
 8 = PanMPO™ male*

Connector Type End 2

5 = MPO female
 6 = MPO male
 7 = PanMPO™ female*
 8 = PanMPO™ male*

Performance/Polarity

A = Standard IL/ Polarity A
 B = Standard IL/ Polarity B
 X = Optimized IL/ Polarity A
 Y = Optimized IL/ Polarity B

Length

1m to 50m (001-050)
 1m increments
 3 ft. to 150 ft. (003-150)
 1 ft. increments

Unit of Length

M = Meters
 F = Feet

Above part number **FXTRP7N7NANM001**: Fiber, OM3 50/125µm 12-fiber 3.0mm round indoor OFNP cable with PanMPO™ female connectors with no variants on both ends, Polarity A – standard IL, 1m in length.

*PanMPO™ option is only available with multimode (OM3/OM4) assemblies.

QuickNet™ Fiber Cable Assemblies – Part Numbers (cont.)

QuickNet™ Small Diameter Trunk Cable Assemblies

Steps to Select:

- 1 Select Cable Options
- 2 Select Ends 1 and 2
- 3 Select Construction/Performance
- 4 Select Length

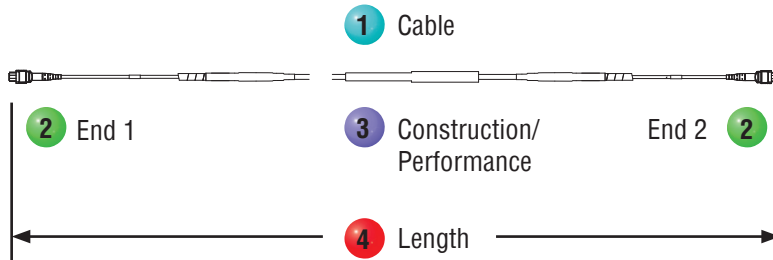

Fiber		Cable			End 1		End 2		Const./Perf	Other	Length			
Fiber	Count	Cable	Jacket	Connector	Variant	Connector	Variant			Unit	3-digit Length			
F	X	U	Y	P	5	E	5	E	A	A	F	1	0	0

Fiber Type

9 = OS1/OS2 9/125µm
X = OM3 50/125µm
Z = OM4 50/125µm

Fiber Count

T = 12-fiber
U = 24-fiber
W = 48-fiber

Cable Type

Y = Indoor small diameter trunk cable

Jacket Type

L = Low Smoke Zero Halogen (LSZH)
P = Optical Fiber Non-conductive Plenum (OFNP)

Connector Type End 1

5 = MPO female
6 = MPO male
7 = PanMPO™ female*
8 = PanMPO™ male*
L = LC Duplex (12-fiber only)

Connector Variant

E = 1m breakout
2 = 2mm overjacket (LC only)

Connector Type End 2

5 = MPO female
6 = MPO male
7 = PanMPO™ female*
8 = PanMPO™ male*
L = LC Duplex (12-fiber only)

Connector Variant

E = 1m breakout
2 = 2mm overjacket/
1m breakout (LC only)

Performance/ Polarity

A = Standard IL/ Polarity A (MPO-MPO)
B = Standard IL/ Polarity B (MPO-MPO)
X = Optimized IL/ Polarity A (MPO-MPO)
Y = Optimized IL/ Polarity B (MPO-MPO)
S = Standard IL/ Standard Polarity (MPO-LC or LC-LC)
O = Optimized IL/ Standard Polarity (MPO-LC or LC-LC)

Length

5m to 100m (005-100)
1m increments
16 ft. to 300 ft. (016-300)
1 ft. increments

Unit of Length

M = Meters
F = Feet

Above part number **FXUYP5E5EAAF100**: Fiber, OM3 50/125µm 24-fiber indoor small diameter trunk plenum cable with MPO female connectors on both ends with 1m breakout variant, Polarity A-standard IL, Pulling eye on End 1, 100 ft. in length.

Longer lengths are available.

*PanMPO™ option is only available with multimode (OM3/OM4) assemblies.

QuickNet™ Fiber Cable Assemblies – Part Numbers

QuickNet™ Trunk Cable Assemblies

Steps to Select:

- Select Cable Options
- Select Ends 1 and 2
- Select Construction/Performance
- Select Pulling Eye Option
- Select Length

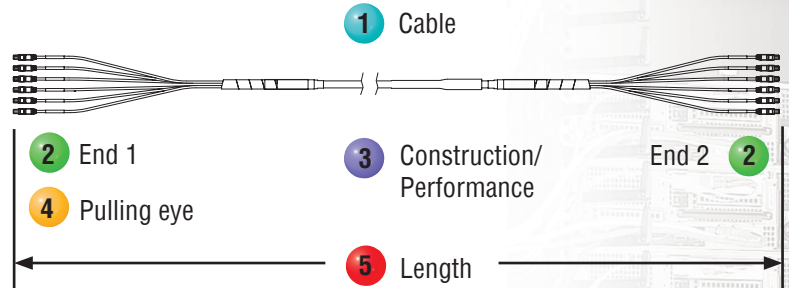

Fiber		Cable			End 1		End 2		Const./Perf	Other	Length			
Fiber	Count	Cable	Jacket	Connector	Variant	Connector	No Variant			Unit	3-digit Length			
F	X	X	S	P	5	E	5	E	A	A	F	1	0	0

Fiber Type

9 = OS1/OS2 9/125µm
 X = OM3 50/125µm
 Z = OM4 50/125µm

Fiber Count

X = 72-fibers

Cable Type

S = Indoor trunk

Jacket Type

L = Low Smoke Zero Halogen (LSZH)
 P = Optical Fiber Non-conductive Plenum (OFNP)

Connector Type End 1

5 = MPO female
 6 = MPO male
 L = LC duplex

Connector Variant

E = 1m breakout
 2 = 2mm overjacket (LC only)

Connector Type End 2

5 = MPO female
 6 = MPO male
 L = LC duplex

Connector Variant

E = 1m breakout
 2 = 2mm overjacket (LC only)

Performance/ Polarity

A = Standard IL/ Polarity A (MPO-MPO)
 B = Standard IL/ Polarity B (MPO-MPO)
 X = Optimized IL/ Polarity A (MPO-MPO)
 Y = Optimized IL/ Polarity B (MPO-MPO)
 S = Standard IL/ Standard Polarity (MPO-LC or LC-LC)
 O = Optimized IL/ Standard Polarity (MPO-LC or LC-LC)

Other

A = Pulling eye End 1

Length

5m to 100m (005-100)
 1m increments
 16 ft. to 30 ft. (016-030)
 1 ft. increments

Unit of Length

M = Meters
 F = Feet

Above part number **FXXSP5E5EAAF100**: Fiber, OM3 50/125µm 72-fiber indoor trunk plenum cable with MPO female to MPO female connectors with 1m breakout, Polarity A-standard IL, pulling eye on End 1, 100 ft. in length.

QuickNet™ Fiber Cable Assemblies – Part Numbers (cont.)

QuickNet™ Harness and Staggered Harness Cable Assemblies

Steps to Select:

- 1 Select Cable Options
- 2 Select Ends 1 and 2
- 3 Select Construction/Performance
- 4 Select Length

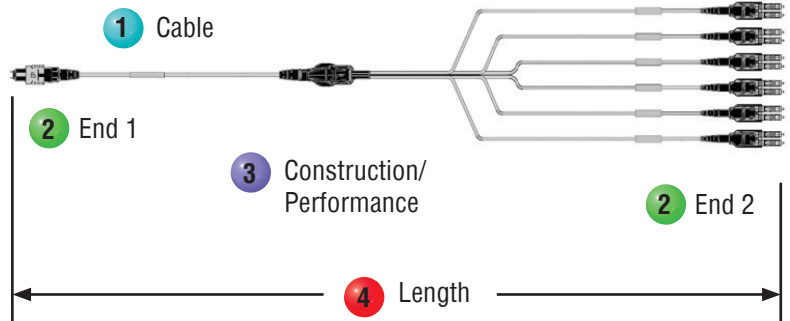

Fiber		Cable			End 1		End 2		Const./Perf	Other	Length									
Fiber	Count	Cable	Jacket	Connector	No Variant	Connector	Variant		None	Unit	3-digit Length									
F	X	T	R	P	6	N	L	S	S	N	M	0	0	3						
Fiber Type 9 = OS1/OS2 9/125µm X = OM3 50/125µm Z = OM4 50/125µm		Fiber Count 8 = 8-fiber T = 12-fiber			Cable Type H = Flat ribbon (OS1/OS2) R = 3.0mm round indoor (OM3/OM4)		Jacket Type L = Low Smoke Zero Halogen (LSZH) P = Optical Fiber Nonconductive Plenum (OFNP)		Connector Type End 1 5 = MPO female 6 = MPO male 7 = PanMPO™ female* 8 = PanMPO™ male*		Connector Type End 2 L = LC duplex U = LC uniboot PanMPO™ (OM3/OM4 only)		Connector Variant D = 1m equal breakout S = 61cm equal breakout N = No variant F = Staggered pair 1 longest breakout G = Staggered pair 1 shortest breakout H = Staggered pairs 1 and 2 longest breakouts J = Staggered pairs 1 and 2 shortest breakouts		Performance/Polarity S = Standard IL/Standard Polarity O = Optimized IL/Standard Polarity Q = 40GbE Migration		Length 1m to 30m (001-030) 1m increments 3 ft. to 100 ft. (030-100) 1 ft. increments		Unit of Length M = Meters F = Feet	

Above part number **FXTRP6NLSSNM003**: Fiber, OM3 50/125µm 12-fiber 3.0mm round OFNP with MPO male connectors with no variant on End 1 and LC Duplex connectors with 61cm equal breakout on End 2, Standard IL-straight thru (MPO Discrete), 3m in length.

*PanMPO™ option is only available with multimode (OM3/OM4) assemblies.
Note: Harness and Staggered Harness Cable Assemblies are not intended to be used for breakout or data rate migration solutions.

QuickNet™ Fiber Cable Assemblies – Part Numbers

QuickNet™ SFQ Trunk Cable Assemblies

Steps to Select:

- 1 Select Cable Options
- 2 Select Ends 1 and 2
- 3 Select Construction/Performance
- 4 Select Length

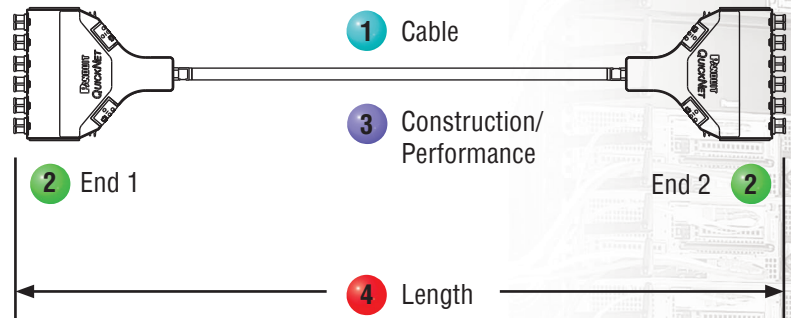

Fiber		Cable			End 1		End 2		Const./Perf	Other	Length			
Fiber	Count	Cable	Jacket	Connector	None	Connector	None		None	Unit	3-digit Length			
F	X	T	S	P	X	N	X	N	S	N	M	0	3	0

Fiber Type

9 = OS1/OS2 9/125µm
X = OM3 50/125µm
Z = OM4 50/125µm

Fiber Count

T = 12-fibers
W = 48-fibers
X = 72-fibers
Y = 96-fibers

Cable Type

S = Indoor trunk

Jacket Type

L = Low Smoke Zero Halogen (LSZH)
P = Optical Fiber Nonconductive Plenum (OFNP)

Connector Type End 1

V = MPO female cassette
X = LC cassette (12F only)
Y = MPO male cassette

Connector Variant

2 = 2.0mm upjacket (LC only)
E = 39° Breakout (MPO only)
N = No Variant (Cassette only)

Connector Type End 2

5 = MPO female connectors
6 = MPO male connectors male connectors
V = MPO female cassette
X = LC cassette (12F only)
Y = MPO male cassette
L = LC Duplex connectors

Performance/Polarity

A = Standard IL/ Polarity A (MPO-MPO)
S = Standard IL/ Standard Polarity (MPO-LC, LC-LC)

Connector Variant

2 = 2.0mm upjacket (LC only)
E = 39° Breakout (MPO only)
N = No Variant (Cassette only)

Length

5m to 30m (005-030)
1m increments

15 ft. to 100 ft. (003-100)
1 ft. increments

Unit of Length

M = Meters
F = Feet

Above part number **FXTSPXNXNSNM030**: Fiber, OM3 50/125µm 12-fiber indoor trunk OFNP cable with LC Cassettes on each end with no variant, Polarity A standard IL, 30m in length.

*PanMPO™ option is only available with multimode (OM3/OM4) assemblies.

Selecting Fiber Optic Cassettes to support your QuickNet™ Fiber Cabling System

SFQ, OptiCom®, and HDQ cassettes are available in OS1/OS2, OM3, OM4, and Signature Core

Modular Cassettes

SFQ

- Streamlined and flexible connectivity solution for use in main, horizontal and equipment distribution areas
- Snap-in rear mount allows for easy installation into an open rack
- Pre-terminated LC, SC and MTP* adapters for quick deployment
- Offered in a wide range of performance and polarity configurations (including 4-to-1 break-out)
- SFQ cassette part numbers begin with FQ and FQ3 (4-to-1 break-out)
- SFQ cassettes snap-in QuickNet™ angled (QAPP24BL) and flat (QPP24BL) patch panels



OptiCom®

- Flexible connectivity solution for use in main, horizontal and equipment distribution areas
- Snap-in front mount allows for easy installation into adapter patch panels or cassette enclosures
- Pre-terminated LC, SC and MTP* adapters for quick deployment
- Offered in a wide range of performance and polarity configurations (including 4-to-1 break-out)
- OptiCom® cassette part numbers begin with FC2 and FC3 (4-to-1 break-out)
- OptiCom® cassettes snap-in OptiCom® fiber adapter patch panels (CFAPPBL1) and QuickNet™ Fiber Cassette Enclosures (FCE1U, FRME1U, FMT1)

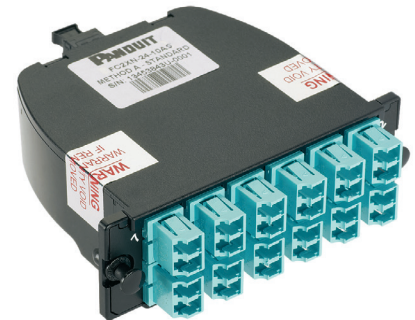

High Density HDQ

- Fixed port connectivity solution for use in main, horizontal and equipment distribution areas
- Robust fixed port design enables high reliability
- High density, up to 144 fibers per RU
- Configured to replicate ports on popular SAN blades from Cisco‡ and Brocade‡‡
- Mounts directly to standard 19" rack rails
- Pre-terminated LC adapters on the front and MTP* adapters on the back enable quick deployments
- Offered in a wide range of performance and polarity configurations
- HDQ cassette part numbers begin with F1R (flat) and F1A (angled)

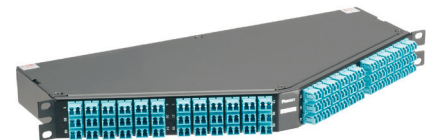

‡Cisco and Cisco Systems are registered trademarks of Cisco Technology, Inc.
‡‡ Brocade is a registered trademark of Brocade Communications Systems, Inc.
* MTP is a registered trademark of US Conec Ltd.

QuickNet™ SFQ Series MTP* Fiber Optic Cassettes

Character	1	2	3	4	5	6	7	8	9	10	11	12
Example	F	Q	X	O	-	1	2	-	1	0	A	S

1 – Fiber Product

F = Fiber

2 – Product Type

Q = QuickNet™

3 – Fiber Type

9 = OS1/OS2 9/125µm (available with standard loss only)

X = OM3 10Gig 50/125µm

Z = OM4 10Gig 50/125µm

4 – Fiber Performance

N = Standard Loss (0.75dB Max. IL)

O = Optimized Cassette (0.5dB Max. IL)

5 – Dash

6, 7 – Fiber Count

06 = 6-fiber total

08 = 8-fiber total

12 = 12-fiber total

8 – Dash

9, 10 – Adapter Type

03 = Duplex SC Adapter (6-fiber only)

10 = Duplex LC Adapter (8 or 12-fiber only)

11, 12 – Polarity

AS = Method A, standard

AF = Modified Method A, pair-flipped

B1 = Method B, B1 (1-1 array)

B2 = Method B, B2 (1-12 array)

*B1 needs to be paired with B2

*B2 needs to be paired with B1

QuickNet™ Opticom® Fiber Optic Cassettes

Character	1	2	3	4	5	6	7	8	9	10	11	12	13
Example	F	C	2	Z	O	-	2	4	-	1	0	A	S

1 – Fiber Product

F = Fiber

2 – Product

C = Cassette

3 – Generation

2 = Second generation

4 – Fiber Type

9 = OS1/OS2 9/125µm (available with standard loss only)

X = OM3 10Gig 50/125µm

Z = OM4 10Gig 50/125µm

5 – Fiber Performance

N = Standard Loss (0.75dB Max. IL)

O = Optimized Cassette (0.5dB Max. IL)

6 – Dash

7 – Numbers of Fibers

06 = 06-fiber total

12 = 12-fiber total

24 = 24-fiber total

9 – Dash

10 and 11 – Adapter Type

03 = Duplex SC Adapter (6 or 12-fiber only)

10 = Duplex LC Adapter (12 or 24-fiber only)

3S = Simplex SC Adapter (6 or 12-fiber only)

12 and 13 – Polarity

AS = Method A, standard

AF = Modified Method A, pair flipped

B1 = Method B, B1 (1-1 array)

B2 = Method B, B2 (1-12 array)

*B1 needs to be paired with B2

*B2 needs to be paired with B1

QuickNet™ Fiber Accessory Part Numbers

Common QuickNet™ Accessories

QuickNet™ Patch Panels:

- Designed to enable rapid installation
- Available in angled or flat versions, standard or all metal
- Standard density (24 ports in 1 RU) or high density (48 ports in 1 RU)
- QuickNet™ Patch Panels include horizontal numbering; for Cassette-terminated switch port harnesses, QuickNet™ High Density Patch Panels with vertical numbering are available with odd numbers across the top row of ports and even numbers across the bottom (to emulate switch port numbering)

QuickNet™ Patch Panel Blank:

- QuickNet™ Panel Blanks are available to block out temporarily unused openings in QuickNet™ Patch Panels to ensure proper airflow.

Other variations may be possible, contact Panduit Customer Service for more information.



Part Number	Part Description	No. of Rack Spaces	Std. Pkg. Qty.	Std. Ctn. Qty.
QuickNet™ Angled Patch Panels (for SFQ Cassettes)				
QAPP24BL	24-port, angled patch panel which accepts QuickNet™ Pre-Terminated Cassettes and Patch Panel Adapters.	1	1	10
QAPP48HDBL	48-port, angled patch panel which accepts QuickNet™ Pre-Terminated Cassettes and Patch Panel Adapters.			
QAPP48HDVNSBL	48-port, angled patch panel which accepts QuickNet™ Pre-Terminated Cassettes and Patch Panel Adapters. Numbering sequence is top to bottom across patch panel.			
QuickNet™ Flat Patch Panels (for SFQ Cassettes)				
QPP24BL	24-port, patch panel which accepts QuickNet™ Pre-Terminated Cassettes and Patch Panel Adapters.	1	1	10
QPP48HDBL	48-port, patch panel which accepts QuickNet™ Pre-Terminated Cassettes and Patch Panel Adapters.			
QPP48HDVNSBL	48-port, patch panel which accepts QuickNet™ Pre-Terminated Cassettes and Patch Panel Adapters. Numbering sequence is top to bottom across patch panel.			
QuickNet™ Cassette Rear Cable Manager (for SFQ Cassettes)				
FQRCM	Manages up to one meter of slack for each of 16 MTP* Interconnect Cables in support of QuickNet™ SFQ Cassettes, QuickNet™ HDQ Cassettes, or QuickNet™ MTP Cassettes.	1	1	10
Opticom® Fiber Adapter Patch Panels (for Opticom® cassettes)				
CFAPPBL1	Flat fiber patch panel. Holds up to four FAP or FMP adapter panels. Also available in angled (CFAPPBL1A) and (CFAPPBL2 and CFAPPBL2A).	1	1	10
Opticom® QuickNet™ Fiber Cassette Enclosures (for Opticom® cassettes)				
FCE1U	Holds up to four QuickNet™ Cassettes, FAP adapter panels. Also available in FCE2U.	1	1	10
Patch Panel Blank				
QPPBBL	QuickNet™ Patch Panel Blank reserves space for future use and promotes proper airflow and cooling. Use QPPLC24 for label/label cover.	1	1	10
Patch Panel Label Kit				
QPPLC24	Label/label cover kit for 24-port QuickNet™ Patch Panels. Each kit contains four labels and four clear label covers per bag.	1	1	10

Complete Solutions from Panduit

Panduit cabinet and rack systems offer a portfolio of innovative products with modular designs for greater thermal management, with energy efficiency, and effective space utilization while managing, showcasing, and protecting equipment.

Panduit Difference

Panduit is committed to delivering a consistently high level of quality and service the world over. With a presence in more than 100 countries, local Panduit sales representatives and technical specialists offer guidance and support that bring value to your business. Our global supply chain, which includes manufacturing, customer service, logistics, and distribution partners, provides prompt response to your inquiries and streamlines delivery to any worldwide destination.

DISCLAIMER: The information contained herein is intended as a guide for use by persons having technical skill at their own discretion and risk. Before using, buyer shall determine the suitability of the Panduit product for his intended use and buyer assumes all risk and liability whatsoever in connection therewith.

WORLDWIDE SUBSIDIARIES AND SALES OFFICES

Panduit US/Canada
Phone: 800.777.3300

Panduit Europe Ltd.
London, UK
cs-emea@panduit.com
Phone: 44.208.601.7200

Panduit Singapore Pte. Ltd.
Republic of Singapore
cs-ap@panduit.com
Phone: 65.6305.7575

Panduit Japan
Tokyo, Japan
cs-japan@panduit.com
Phone: 81.3.3767.7011

Panduit Latin America
Guadalajara, Mexico
cs-la@panduit.com

Phone: 52.33.3777.6000
Panduit Australia Pty. Ltd.
Victoria, Australia
cs-aus@panduit.com
Phone: 61.3.9794.9020

For a copy of
Panduit product warranties,
log on to www.panduit.com/warranty

**For more information
Visit us at www.panduit.com**

**Contact Customer Service by email:
cs@panduit.com
or by phone: 800-777-3300**

PANDUIT®

©2017 Panduit Corp.
ALL RIGHTS RESERVED.
Printed in the U.S.A.
FBAG01--WW-ENG
8/2017