

Installation Instructions for R-Frame G-Series (RG) 310+ Trip Unit



Contents

Description	Page
1. Removal of R-Frame Electronic Seltronic (RES) Trip Unit and Obsolete Components	2
2. Edge Connector and C/D Terminal Block Replacement (Refer to Guidelines)	4
3. Installing the RG 310+ Trip Unit	6
4. RG 310+ Trip Unit with Components and Hardware of the RG 310+ Retrofit Kit.	9
5. Wiring Directions for Edge Connector Replacement - Dependent on Original Equipment	10
Appendix A. Wiring Diagram	13



Powering Business Worldwide

⚠ WARNING

READ AND UNDERSTAND THE INSTRUCTIONS CONTAINED HEREINAFTER BEFORE ATTEMPTING TO UNPACK, ASSEMBLE, INSTALL, OPERATE, OR MAINTAIN THIS EQUIPMENT.

HAZARDOUS VOLTAGES MAY BE PRESENT INSIDE ENCLOSURES THAT CAN CAUSE DEATH OR SEVERE PERSONAL INJURY. FOLLOW PROPER INSTALLATION, OPERATION, AND MAINTENANCE PROCEDURES TO AVOID THESE VOLTAGES.

All possible contingencies that may arise during installation, operation, or maintenance, and all details and variations of this equipment do not purport to be covered by these instructions. If further information is required by the purchaser regarding a particular installation, application, or maintenance activity, please contact an authorized Eaton sales representative or your Eaton Engineering Sales & Services (EESS) engineer.

⚠ CAUTION

GENERAL SAFETY INSTRUCTIONS

- **ONLY QUALIFIED ELECTRICIANS SHOULD PERFORM INSTALLATION AND MAINTENANCE WORK ON THIS EQUIPMENT.**
- **DISCONNECT ALL POWER TO THE UNIT PRIOR TO SERVICING.**
 - **ALARM CONTACTS MAY BE CONNECTED TO POWER FROM OTHER SOURCES**

1. Removal of R-Frame Electronic Seltronic (RES) Trip Unit and Obsolete Components

Step 1.

Remove the clear trip unit cover from the breaker cover by loosening the thumb-screws. Loosen the breaker cover screws and remove the breaker cover.



Figure 1. Trip Unit Clear Cover Removed.

Step 2.

Locate the trip unit you wish to remove.



Figure 2. Trip Unit to Be Removed.

Step 3.

“Unlock” the rating plug.



Figure 3. Unlocking the Rating Plug.

Step 4.

Remove the rating plug from the old trip unit.

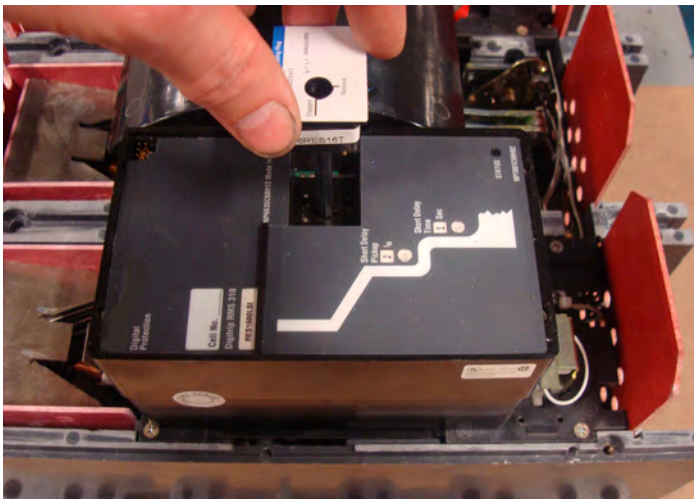

Figure 4. Removing the Rating Plug from Trip Unit.

Step 5.

Clear the two metal retaining clips, found on each end, from the old trip unit

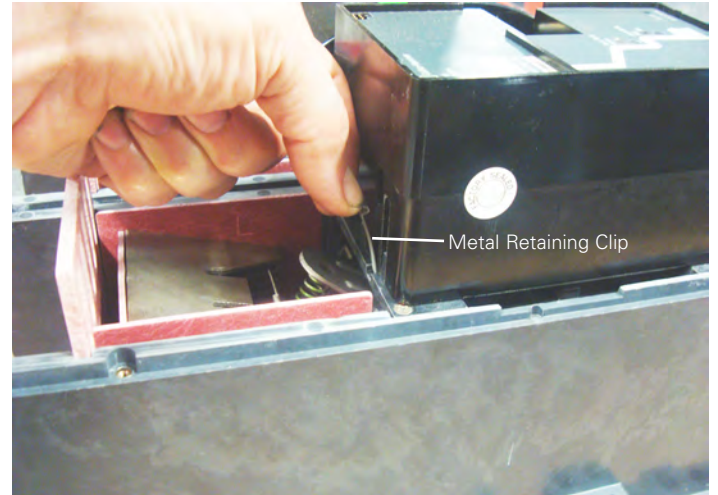

Figure 5. Location of the Metal Retaining Clips.

Step 6.

Remove the old trip unit from the breaker (revealing the edge connector).

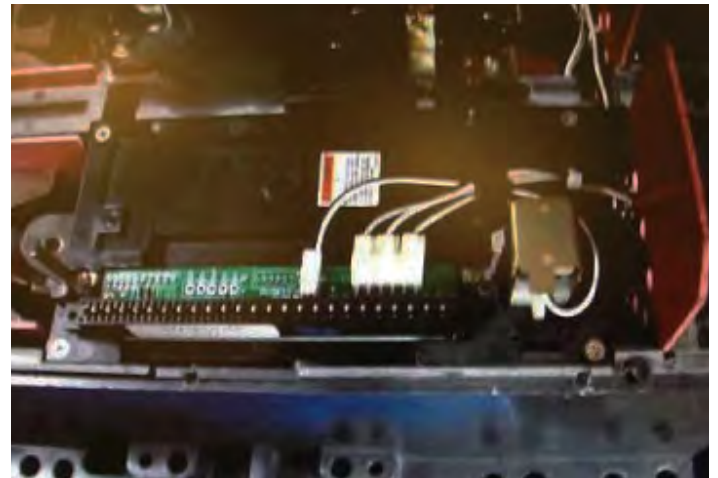

Figure 6A. Trip Unit Removed and Type “A” Edge Connector Revealed.

Note: The edge connector shown in Figure 6A is a Type “A” edge connector, as referenced in Figure 27 from the four possible types of edge connectors.

2. Edge Connector and C/D Terminal Block Replacement (Refer to Guidelines)

To replace/install the C/D terminal block on the side of the breaker, proceed with the steps that follow.

Step 1.

Locate the mounting plate for the C/D terminal block and the self-tapping screws that allow for mounting the plate even if the back-side of the breaker is not accessible.

Step 2.

Mount the plate by installing the self-tapping screws through the clearance holes in the plate (two largest holes) and threading them into the two smallest holes in the left hand side of the breakers base (directly above the screws shown in Figure 7).

Note: If the breaker already has a C/D terminal block installed, the existing mounting plate should be used.



Figure 6B. Trip Unit Removed and Type "C" Edge Connector Revealed.

Note: The edge connector shown in Figure 6B is a Type "C" edge connector, as referenced in Figure 27 from the four possible types of edge connectors.

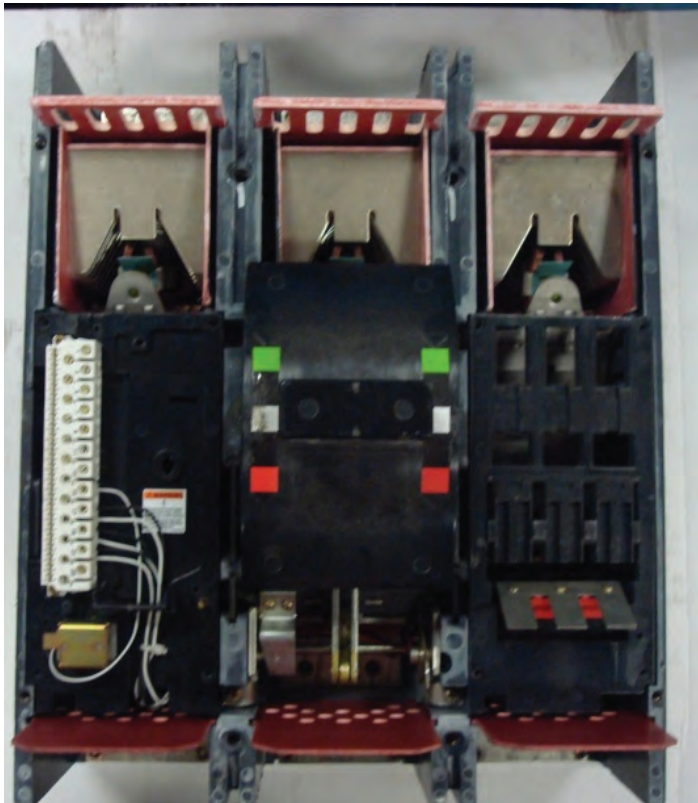

Figure 6C. Trip Unit Removed and Type "D" Edge Connector Revealed.

Note: The edge connector shown in Figure 6C is a Type "D" edge connector, as referenced in Figure 27 from the four possible types of edge connectors.



Figure 7. Orientation of the C/D Terminal Block Mounting Plate and Hardware.

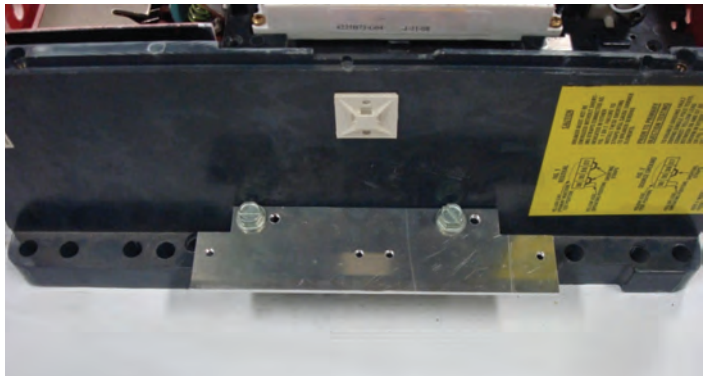

Figure 8. C/D Terminal Block Mounting Plate Installed on the Base.

Step 3.

If the breaker already has a C/D terminal block, remove the terminals C11/C12 and D11/D12 from the mounting rail to expose the rail mounting screws. Remove the two rail mounting screws and transfer any existing wires to the new retrofit C/D terminal block assembly.

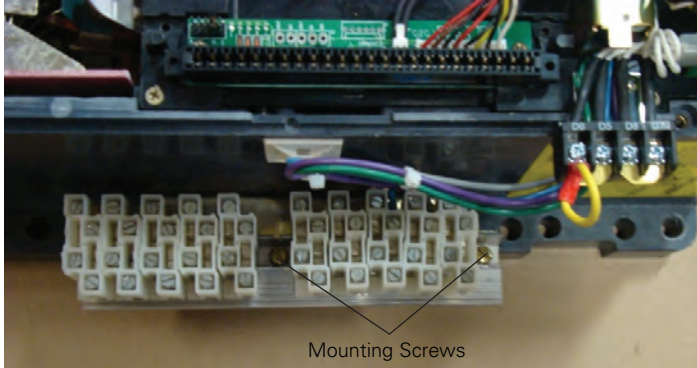

Figure 9. Location of the Rail Mounting Screws.

Note: Figure 10 shows an R-Frame G Series (RG) Retrofit Kit supplied pre-wired edge connector board and C/D terminal block assembly.

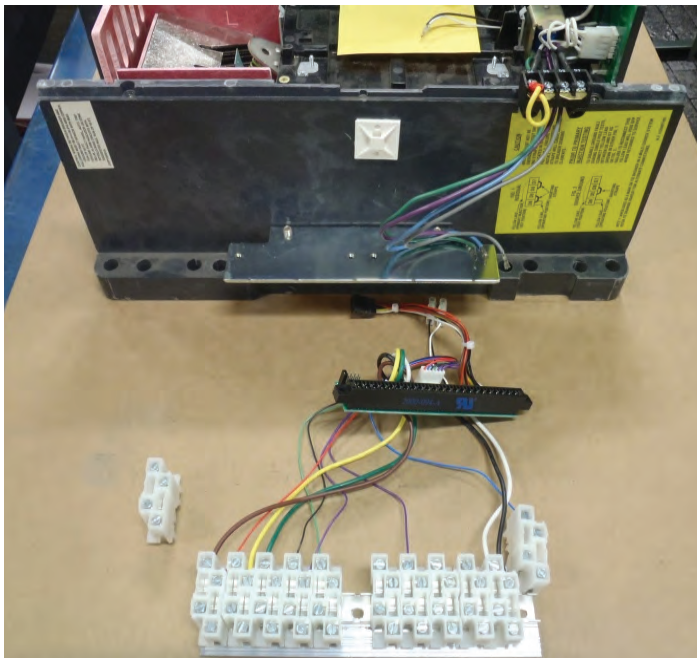

Figure 10. Pre-wired Edge Connector Board and C/D Terminal Block Assembly – As Supplied with RG Retrofit Kit.

Step 4

Begin the reassembly starting with the termination of wires D5-D8 in the new C/D block on GF style breakers (as done by the installer).

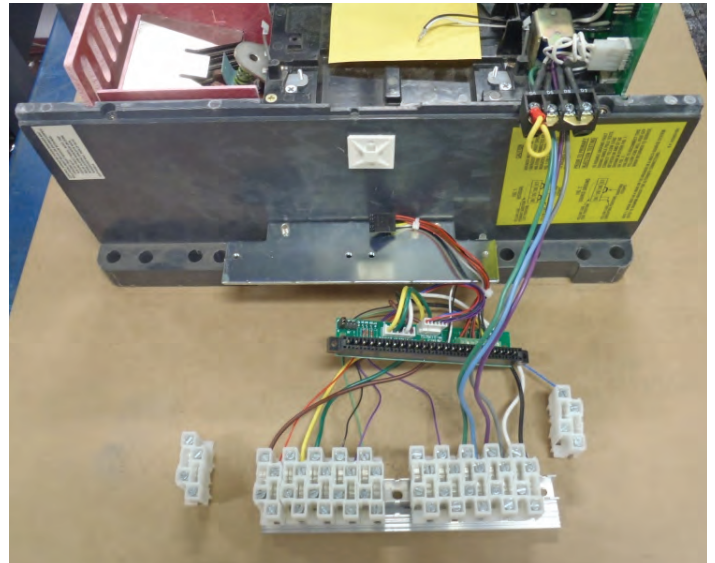

Figure 11. Termination of Wires D5-D8 in the New C/D Block.

Step 5.

Install the rail using two screws (Type F - see Fig. 26) then continue with the C/D terminal block installation by installing the C11/C12 and D11/D12 terminals onto the rail. The terminal blocks simply push down onto the rail and snap in place. At this point, the terminal identification strip can be installed onto the C/D block. It also is a press fit into the top of the terminals, centered between the terminal screws.

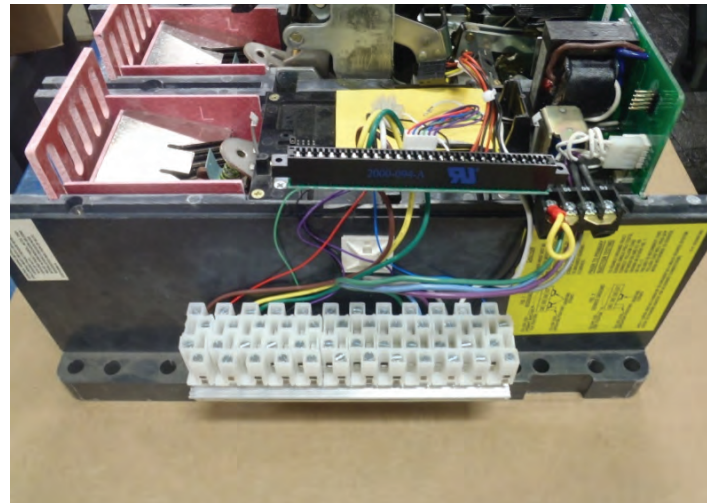

Figure 12. Rail Installed with C11/C12 and D11/D12 Terminals Connected.

Step 6.

Figure 13 shows the preparation for mounting the new style edge connector boards to an existing R-Frame Domestic (RD) deck that originally had a white terminal block, as in Figure 6C. The points to note are where the "T" (top) and "B" (bottom) adapter/spacers have been installed. They can be seen in place, held to the deck with Phillips head screws, and the male threads of the screws for the edge connector board protruding from the back side of the adapters (they look similar to an "L" shaped piece of nylon).

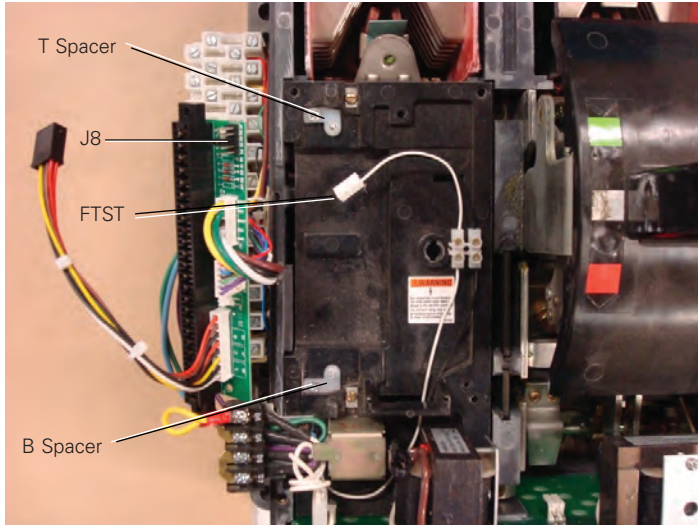

Figure 13. New Style Edge Connector Board Prepared for installation on an RD Deck.

Note: The top and bottom nylon spacers have already been added to the black mounting plate.

Note: The edge connector must sit on top of the nylon spacers and held on with the two nylon hex nuts. The addition of a two-position connector for the Flux Transfer Shunt Trip (FTST) leads has also been added in Figure 13.

Note: Verify over-ride jumper position - J8 position: 16 or 20 or 25.

Step 7.

The new edge connector board is mounted to the deck, and current transformer (CT) wiring routed and connected to the green board. The connector for the CT wiring will fit through the opening on the deck. Care must be taken to ensure the wiring, FTST, and green board CT are not damaged during this process.

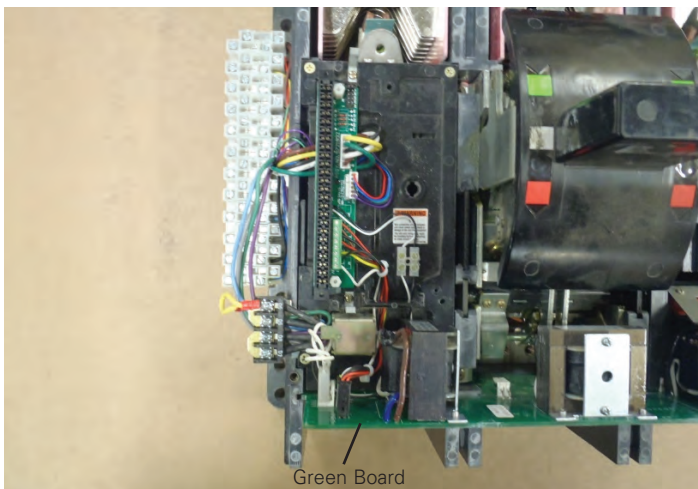

Figure 14. Routing and Connection of the CT Wiring.

3. Installing the RG 310+ Trip Unit

Step 1.

Install the new RG 310+ trip unit by lining up its base to the guides in the deck and seating into place.

Note: Printed circuit board and edge connector must align before seating the trip unit.



Figure 15. Installing the RG 310+ Trip Unit.

Step 2.

Locate the trip unit interlock shaft.

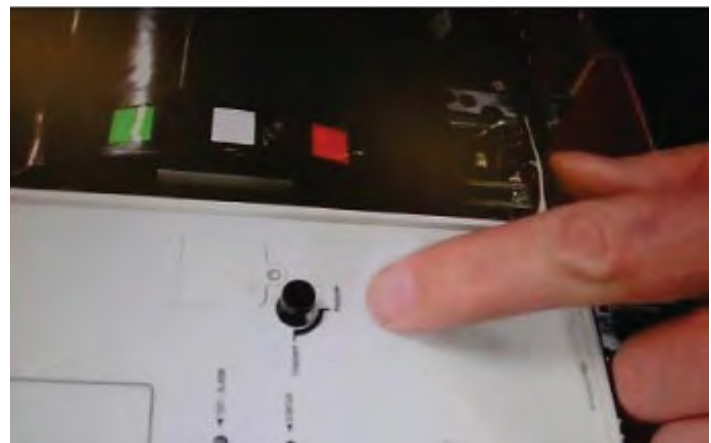

Figure 16. Location of the Trip Unit Interlock Shaft.

Step 3.

Rotate the interlock to the "Engaged" position using a flat head screwdriver.

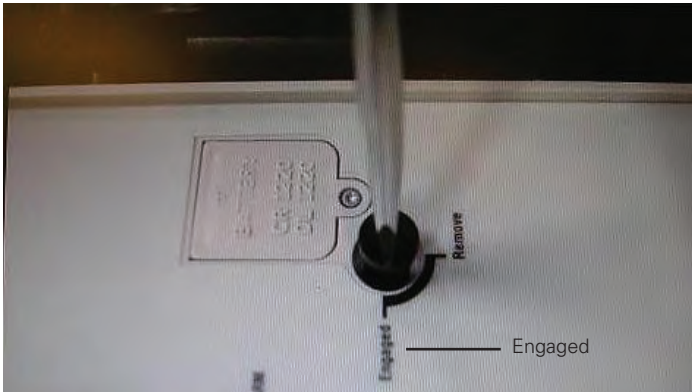

Figure 17. Engagement of the Interlock Shaft.

Note: The new RG 310+ trip unit is installed in place of the original RES trip unit. The new RG 310+ trip units include a captive shaft interlock to replace the interlock that was part of the RES trip unit rating plug.

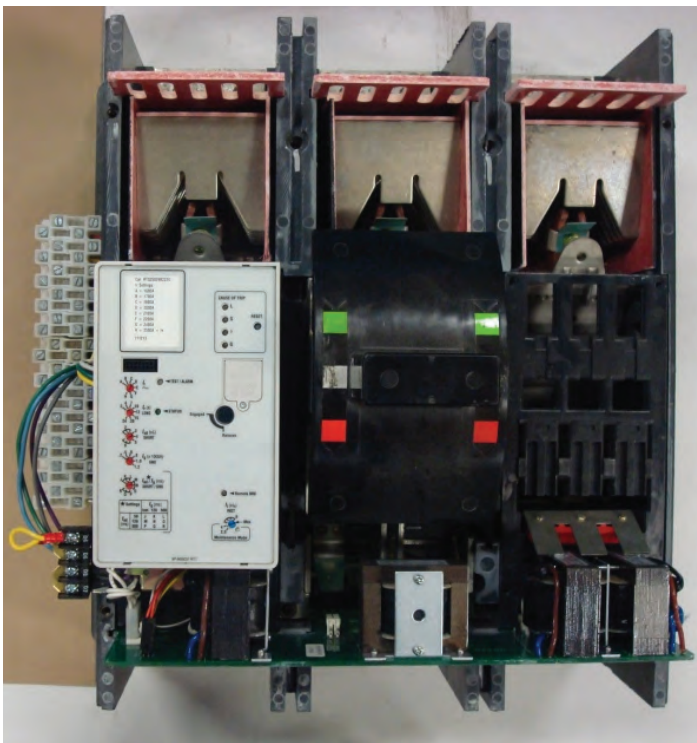

Figure 18. RG 310+ Trip Unit installed in the Breaker

Step 4.

The side view of RD breaker cover (see Figure 19) shows where accessory wires need to exit. The filler plate that needs to be removed is located on left hand side of cover. The filler will need to be removed for clearance of the wires as they exit the breaker and are terminated in the C/D terminal blocks. The barrier is glued in, and will need to be broken or cut out.

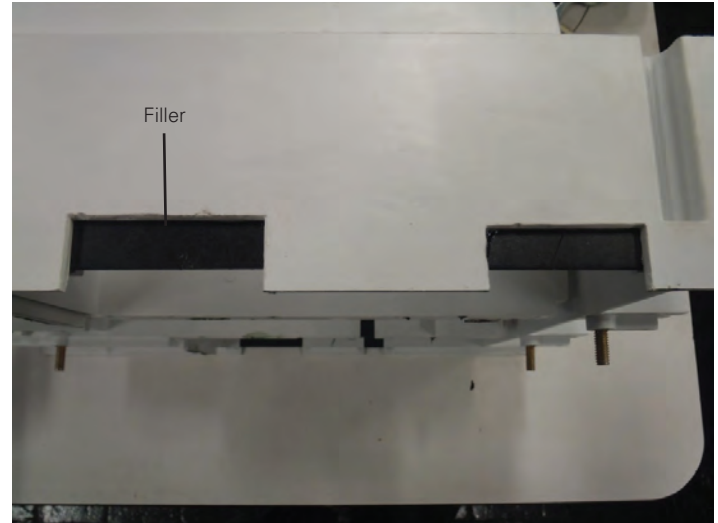

Figure 19. Location Where the Accessory Wires Will Exit the Breaker.

Step 5.

Replace the breaker cover.



Figure 20. Replacing the Breaker Cover.

Step 6.

Tighten all of the cover screws (torque to 26 in/lbs [2.94 Nm]).

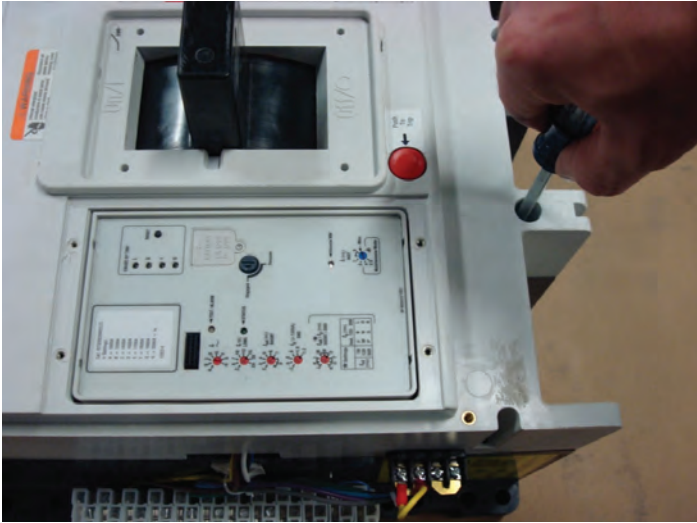

Figure 21. Tightening the Breaker Cover Screws.

Step 8.

Set the trip unit to desired settings and install the new clear trip unit cover. Verify tripping operation with test kit MTST230V standard.

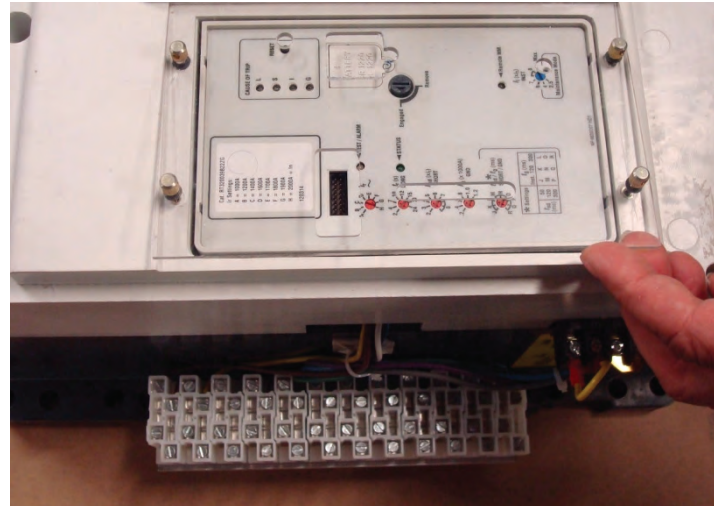

Figure 23. Setting the Trip Unit for Testing and Operation.

Step 7.

Figure 22 shows the correct routing of the accessory wiring, exiting the left side of an RD retrofitted breaker.

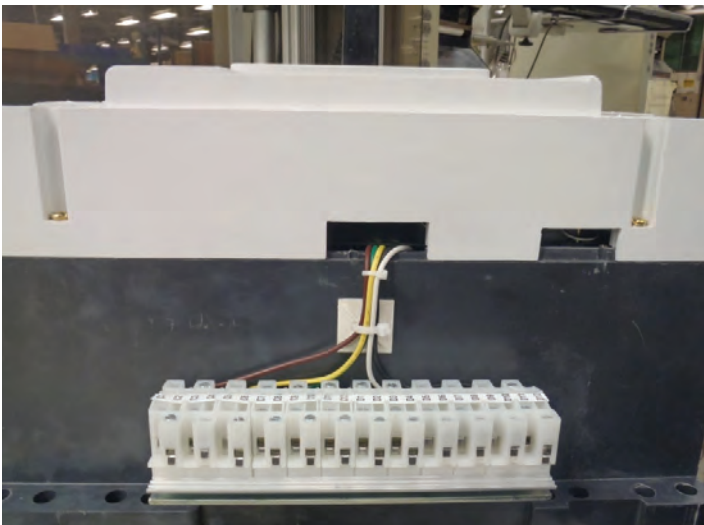

Figure 22. Accessory Wiring Exiting the Left Side of the Breaker.

Step 9.

Fill out the Retrofit information then install the supplied Retrofit Label on the cover so that it does not cover any of the information or functionality of the trip unit. Installation is complete.

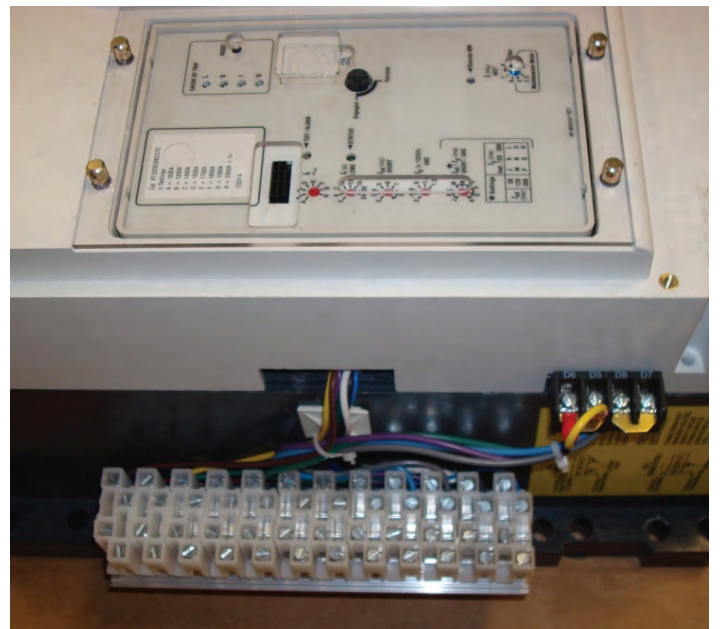

Figure 24. Breaker with Trip Unit Cover Installed (Note: Retrofit Label Not Shown in Photo).

4. RG 310+ Trip Unit with Components and Hardware of the RG 310+ Retrofit Kit

Figure 25 shows the components that are included in an RG Retrofit Kit. The trip unit is a typical sample, and the one shown in Figure 25 has the visible option of Arc Reduction Maintenance System (ARMS) in a ground fault (GF) trip unit. Actual kit trip units will vary, depending on order requirement. Contents include:

- Trip unit;
- Terminal block mounting plate; and
- C/D terminal block/edge connector assembly (pre-wired for customer installation).

The hardware and label that are included in a kit is shown in Figure 26.

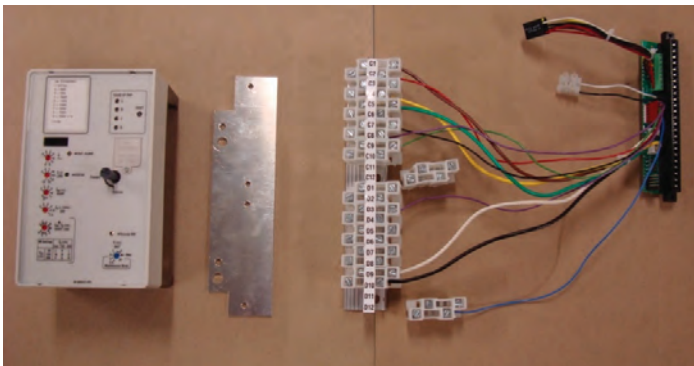

Figure 25. Retrofit Parts.

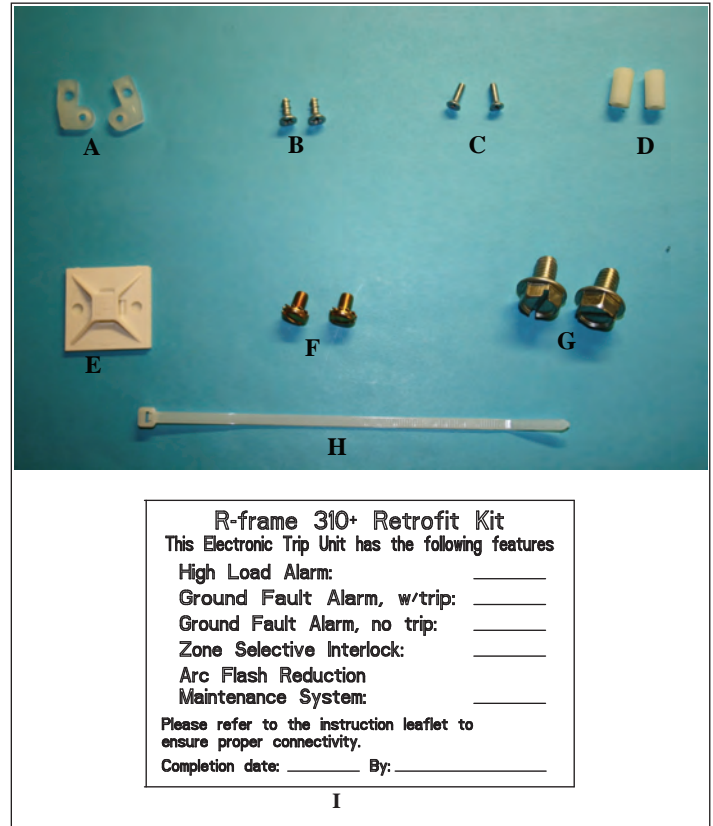

Figure 26. Supplied Hardware and Retrofit Label.

Table 1. Supplied Hardware, Part Numbers, and Quantities.

Description	Style #	Quantity
A. Spacer "T"	66A7786H02	1
Spacer "B"	66A7786H01	1
B. Screw Hi-Lo Phillips #6 x 0.375"	70010LX13P	2
C. Screw Phillips Flat Head #4-40 x 0.375"	70001CY41H	2
D. Hex Spacer 4-40 x 0.50"	70570CIA03	2
E. Cable Tie Mount	5068A95G06	1
F. Pan Head Screw #10-32 x 0.31"	70030ATJ8H	2
G. Hex Washer Head Slotted 0.31-18 x 0.50"	70010MKCFQ	2
H. Cable Tie	70801CL42C	1
I. Retrofit Label	66A7808	1

Figure 27 shows the four possible connectors on existing RD breakers with RES trip units.

The “A” edge connector is the “new” style, as found in a 1600A 3-pole breaker. This one is unique in that the FTST and all three of the CT terminations are made with 2-pole connectors, and plug into the “old” board. This breaker would also NOT have a green board.

The “B” edge connector is not likely to be found in breakers in the field, but it could be. If found, it would be in conjunction with a green board, and any one of the three frame ratings.

The “C” edge connector is the most common found in breakers produced since the switch to an edge connector in place of a terminal block. It is used in 3-pole, 2000A and 2500A frames, as well as all three frame ratings that are GF breakers.

The “B” and “C” edge connectors have a set of leads that plug into the green board for the four possible CT signals. The replacement RG retro edge connector board has that same set of leads.

The “D” edge connector is what would be found in “old” breakers, of any current rating, GF or non-GF, 3-pole or 4-pole. It is also what was used in the “old” 3-pole 1600A non-ground fault breakers and is different in that case as the wires for the CT’s go directly to the terminal block and there is no green board.

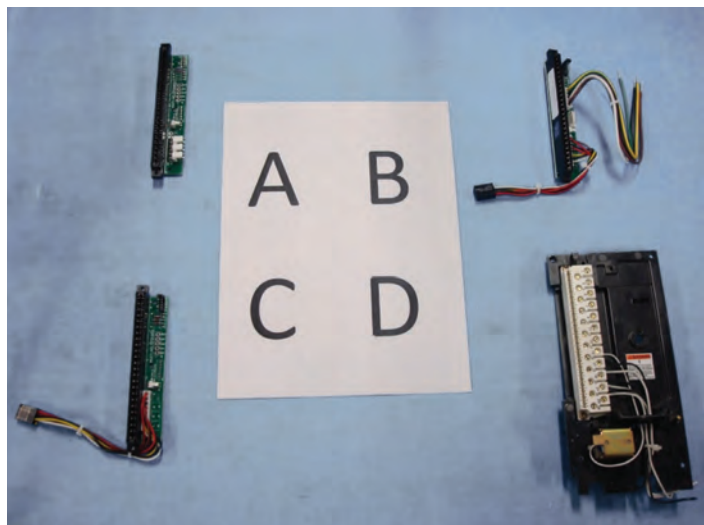

Figure 27. Possible Edge Connector Assemblies in the Field.

5. Wiring Directions for Edge Connector Replacement - Dependent on Original Equipment

The FTST connections, white and black wire pair from original terminals 14 and 15 (or connector J6), will need to be attached to the new wires and terminal block that connect to the retrofit edge connector board at J6 (black to black, white to white). To transfer the three sets of CT wires found in a 3-pole 1600A frame with edge connector board (Figure 27, Item A), to the RG retrofit edge connector board as seen in Figure 25, complete the steps that follow.

Step 1.

Remove all of the supplied wires from the new edge connector board that are terminated in the J2 connector. This plug assembly will not be used in the conversion.

Step 2

Unplug the connector from the original edge connector board location “R”/J3 and cut the connector off (leave the wires in the breaker as long as possible).

Step 3.

Strip the wires 3/16” (4.8 mm) and insert the black wire into terminal 6 of terminal block J2 on the new edge connector board.

Step 4

Insert the white wire into terminal J2-5. Continue by unplugging the connector from “C”/J4, strip the leads as before and install the black wire to terminal J2-4, and the white wire to terminal J2-3.

Step 5

Finish the CT connections by removing the connector from “L”/J5 and terminate as before, with the black wire in terminal J2-2 and the white wire in terminal J2-1.

5.1. White Terminal Block

If the breaker to be retrofitted in the field has a white terminal block inside instead of an edge connector board, the following steps need to be taken to terminate the CT leads into the new retrofit edge connector board.

Step 1.

Remove all of the supplied wires from the new edge connector board that are terminated in the J2 connector. This plug assembly will not be used in the conversion. Table 2 lists the wires that need to be transferred from the original terminal block to the terminal block on the retrofit edge connector board.

Table 2. Wires to Transfer from Original Terminal Block to the Retrofit Edge Connector Board.

Original Terminal Block Wire Location	New Terminal Location
3	J2-8
4	J2-7
17	J2-6
18	J2-5
19	J2-4
20	J2-3
21	J2-2
22	J2-1

Note: If the field breaker originally contains an edge connector board with eight leads soldered in the J2 position, the retrofit edge connector board can be plugged in as a direct replacement by unplugging the original harness from the green Auxiliary CT board and plugging the new harness into the Auxiliary CT board.

5.2. Guidelines for RG 310+ Retrofit Kits

1. All retrofits require new edge connector boards that contain the new override diodes.
2. C/D terminal blocks must be added or replaced if new accessories are installed.
3. 1600A non-ground fault frames with “old” white terminal block/edge connector (Type D in Figure 27) are all hard wired (no connectors) and must be removed and replaced with Eaton’s new terminal block system.
4. 2000A/2500A, 3-pole non-ground fault breakers with “old” white terminal block/edge connector - This type already has a green board but with white block and color-coded wires/connector. Replace with new pre-wired edge connector board containing color-coded wires/connector.

5.3. Verbal Flow Chart of Retrofit Procedure

1. What RD breaker style does the customer wish to retrofit?
 - A. 1600A – No ground fault (no green CT board inside) – Must add C/D block if adding accessories.
 - B. Any current rating with no ground fault – Must add C/D block if adding accessories.
 - C. Any current rating with ground fault – Should already have C/D block.
 - D. Other – 4 pole – Must add C/D block if adding accessories.
2. Modify to: (align with letters from 1 above)
 - A. Install the new edge connector board and add C/D block if adding accessories – 3-pole 1600A with no ground fault can be Long and Short Delay Adjustable Settings (LS), Long, Short, and Instant Adjustable Settings (LSI) - This limits accessories to: Zone Selective Interlock (ZSI), Remote Maintenance Mode (RMM), and High Load Alarm Relay.
 - B. Install the new edge connector board and add pre-wired C/D block if adding accessories.
 - C. Install the new edge connector board and replace C/D block with pre-wired C/D block.
 - D. Install the new edge connector board and install pre-wired C/D block if adding accessories.

5.4. Basic Steps:

1. Identify the frame size and breaker features:
 - Current rating (1600A, 2000A, or 2500A);
 - 3-pole or 4 pole;
 - GF or non-GF; and
 - Does the breaker already have a C/D block.
2. Identify the edge connector type: remove the trip unit and inspect (refer to Section 5.5 on the four possible types below).
3. Identify if an external C/D terminal block is needed.

5.5 Four Possible Edge Connector Types Exist for RD Breakers with RES Trip Units: (Refer to Figure 27)

1. Fig. 27, Ref. A - Used in 1600A non-GF 3-pole frames. All three phases and FTST have white 2-pin pluggable mating connectors. There is only one override diode and it is fixed.
2. Fig. 27, Ref. B + C - Used in 2000A and 2500A non-GF frames that have an Auxiliary CT board inside referred to as a “green board”. The override diode is jumper (J8) selectable per the frame rating.
3. Fig. 27, Ref. B + C - Used in all three GF frame ratings (1600A, 2000A, and 2500A) with “green board”. The override diode is jumper (J8) selectable per the frame rating.
4. Fig. 27, Ref D - White terminal block/edge connector – Oldest type used for all three frames, GF or non-GF, 3-pole and 4-pole – all CT and FTST connections are wires that terminate in the terminal block via screw down terminals. Override diode (frame rating specific) installed in terminals 10 + 11.

Note: Types 2. and 3. above have three override zeners - jumper selectable for the three different frames.

5.6 Edge Connector Replacement

Note: Since the override diodes for the RG 310+ trip units are different than those for the RES 310 trip units, all edge connectors must be replaced with those supplied in the kit. However, spacers may or may not be required as explained below (refer to Figure 13 and 28).

1. If the edge connector being replaced is the white ceramic terminal block type, the spacer kit (See Fig. 26, Items A, B, C, and D) must be used. Refer to drawing #6D32435 (see Figure 28) for details.

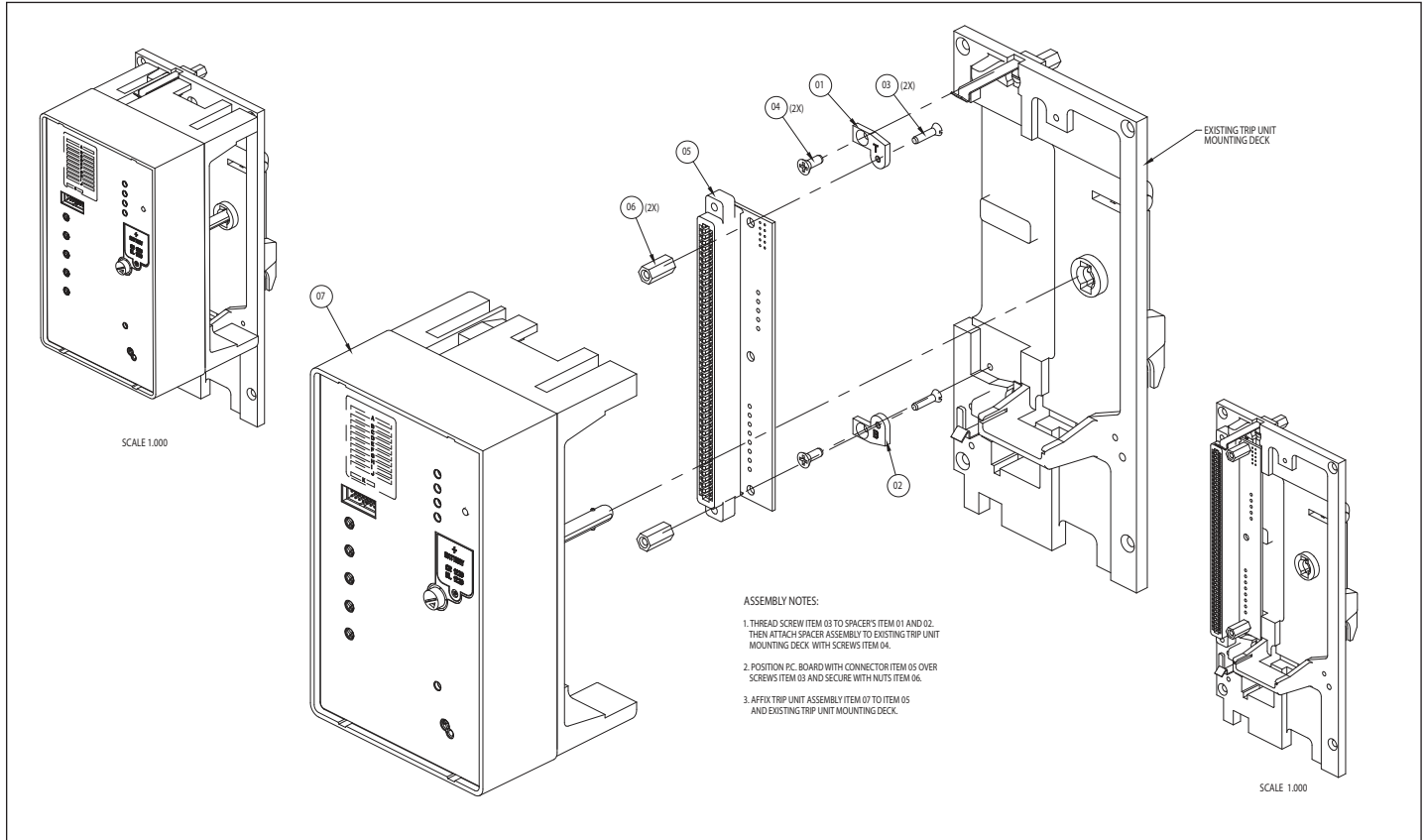

Figure 28. Drawing #6D32435.

2. If the breaker contains an edge connector mounted to a PC board, the new edge connector PC board is a direct replacement, held in with the two original mounting screws.

5.7. C/D Terminal Block Replacement

Note: All RD GF breakers have a C/D terminal block mounted on the left side of the breaker. This block can be reused/replaced and rewired to include the accessories such as ZSI, RMM, and any Alarm Relay outputs (refer to Figures 14 and 15).

Note: Refer to Figure 22. If the breaker does not have a C/D block already and accessory wiring is needed, the kit supplied C/D mounting plate must be installed. Refer to Figures 7 and 8 for details. After the mounting plate has been installed, the pre-wired C/D block and edge connector assembly can be installed (refer to Figures 10, 11, 12, 13, and 14).

5.8. Wiring of C/D Terminal Block

Note: Please refer to the wiring diagram (RD Master Connection Diagram – RG310+ Trip Unit) in Appendix A for information concerning the following process.

1. The accessory wiring to the terminal block can be completed either by using the pre-wired terminal block (Figure 10 or 25) or following the directions along with the picture in Figure 11.
2. The C/D block has a terminal identification label used to indicate the terminal numbers of the C/D block: C1 through C12, and D1 through D12.
3. Please note the C/D terminal positions of wiring before removing old wires.

Appendix A

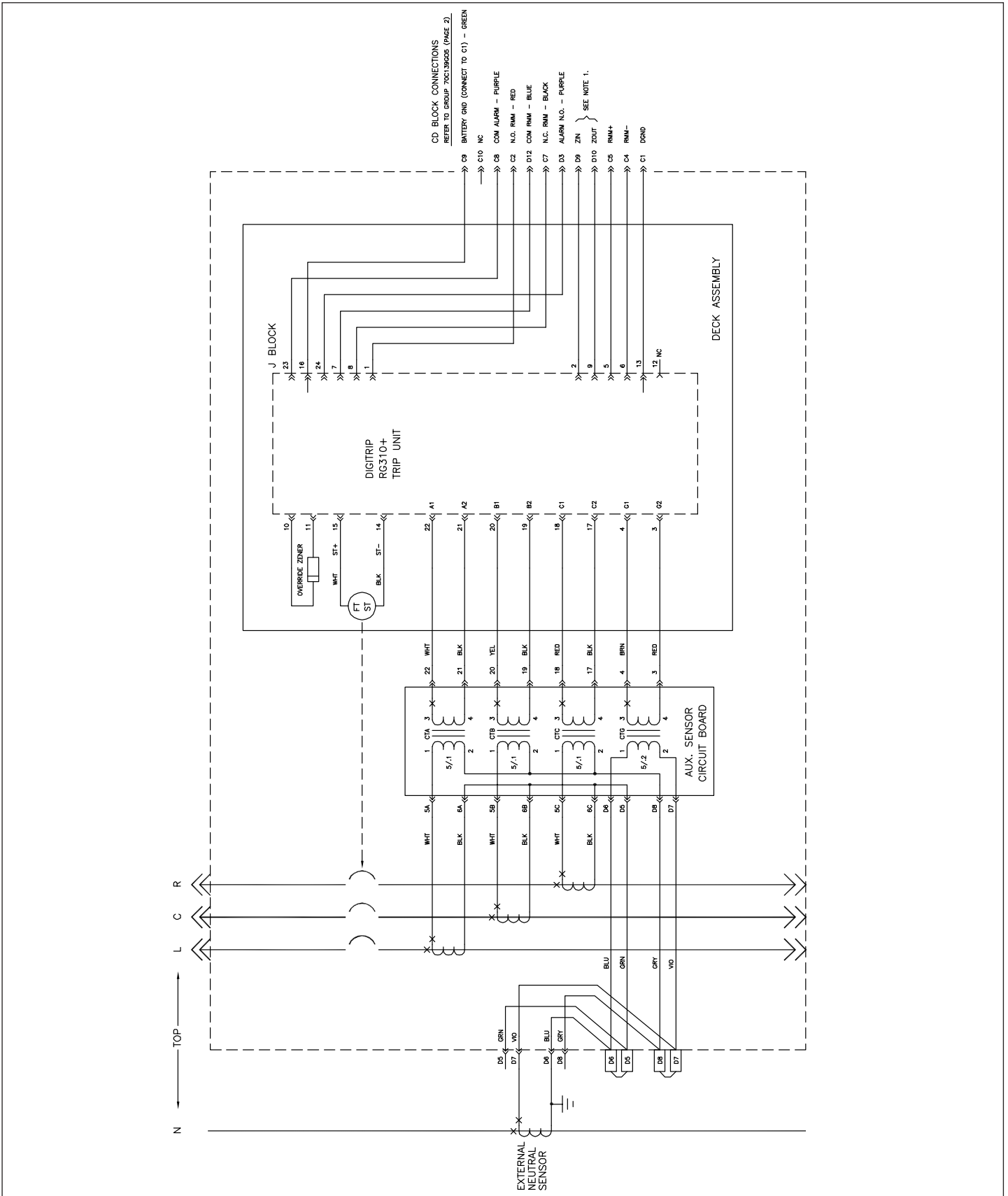

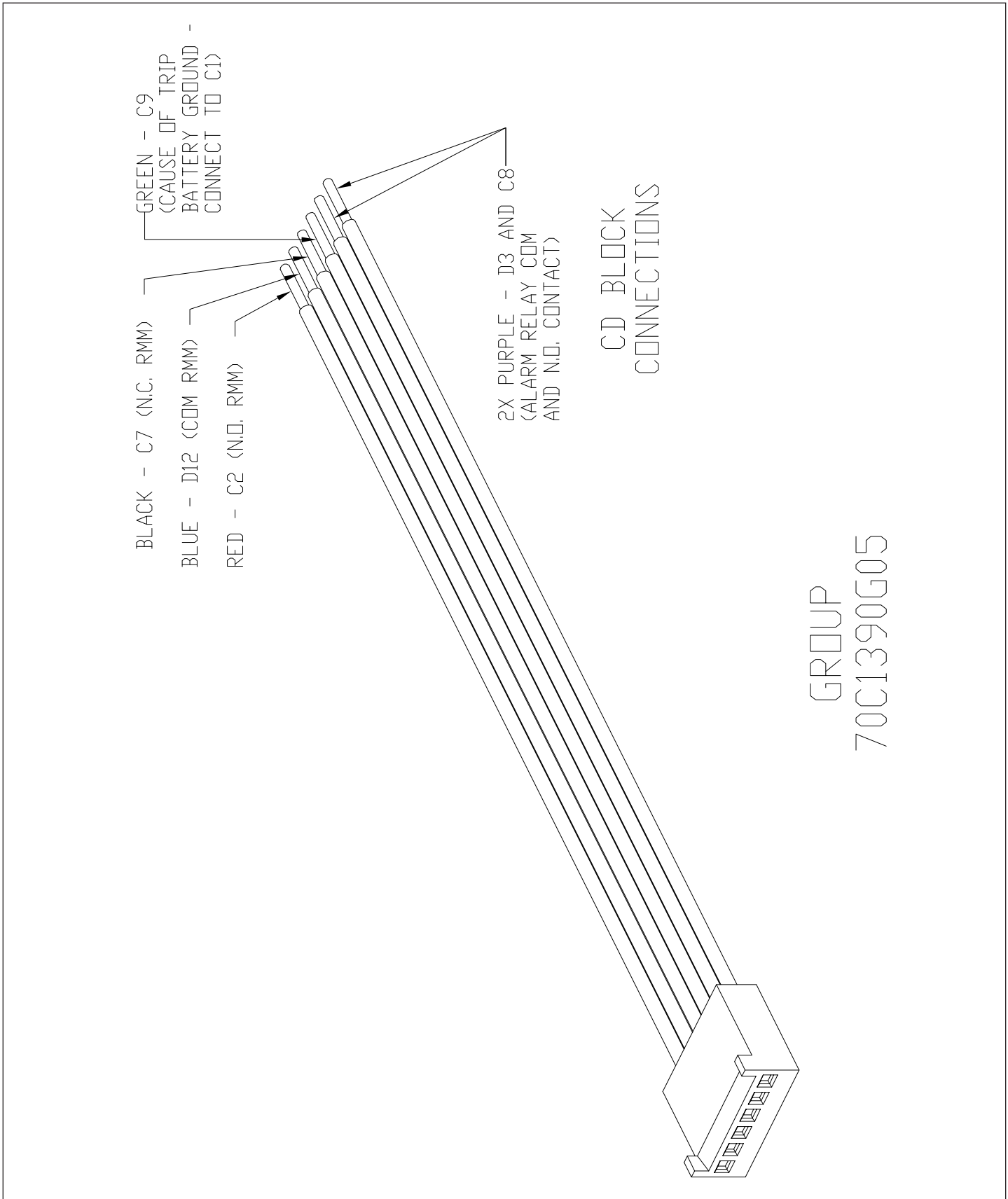

Figure 30. Wiring Diagram.

Notes:

Effective October 2012

The instructions for installation, testing, maintenance, or repair herein are provided for the use of the product in general commercial applications and may not be appropriate for use in nuclear applications. Additional instructions may be available upon specific request to replace, amend, or supplement these instructions to qualify them for use with the product in safety-related applications in a nuclear facility.

The information, recommendations, descriptions, and safety notations in this document are based on Eaton's experience and judgment with respect to Power System Protection. This instructional literature is published solely for information purposes and should not be considered all-inclusive. If further information is required, you should consult an authorized Eaton sales representative.

The sale of the product shown in this literature is subject to the terms and conditions outlined in appropriate Eaton selling policies or other contractual agreement between the parties. This literature is not intended to and does not enlarge or add to any such contract. The sole source governing the rights and remedies of any purchaser of this equipment is the contract between the purchaser and Eaton.

NO WARRANTIES, EXPRESSED OR IMPLIED, INCLUDING WARRANTIES OF FITNESS FOR A PARTICULAR PURPOSE OR MERCHANTABILITY, OR WARRANTIES ARISING FROM COURSE OF DEALING OR USAGE OF TRADE, ARE MADE REGARDING THE INFORMATION, RECOMMENDATIONS, AND DESCRIPTIONS CONTAINED HEREIN. In no event will Eaton be responsible to the purchaser or user in contract, in tort (including negligence), strict liability or otherwise for any special, indirect, incidental or consequential damage or loss whatsoever, including but not limited to damage or loss of use of equipment, plant or power system, cost of capital, loss of power, additional expenses in the use of existing power facilities, or claims against the purchaser or user by its customers resulting from the use of the information, recommendations and description contained herein.

Eaton Corporation
Electrical Sector
1111 Superior Ave.
Cleveland, OH 44114
United States
877-ETN-CARE (877-386-2273)
Eaton.com

© 2012 Eaton Corporation
All Rights Reserved
Printed in USA
Publication No. IL01210020EH02 / TBG000953
October 2012