

PLEASE CHECK WWW.MOLEX.COM FOR LATEST PART INFORMATION

Part Number: [1300140042](#)
Status: **Active**
Overview: Brad Mini-Change Connectors
Description: Mini-Change B-Size Receptacle with Leads 1/2" - 14 NPT Threads, Female (Straight) 7 Poles, 1.83m (6.0') Length

Documents:

[Drawing \(PDF\)](#) [RoHS Certificate of Compliance \(PDF\)](#)

Agency Certification

CSA LR6837
 UL E152210

General

Product Family Industrial Receptacles
 Series [130014](#)
 Comments B-Size (1" - 16 UN-2A)
 IP Rating IP67
 NEMA Rating NEMA 6
 Overview [Brad Mini-Change Connectors](#)
 Product Name Mini-Change
 Type Single Ended (pigtail)
 UPC 78678844071

Physical

Coupling Type External Thread
 Gender Female
 Keyway Single
 Length 1.83m
 Material - Component Zinc Die-Cast with Black Epoxy
 Mounting Thread Size 1/2" - 14 NPT
 Orientation Straight
 Panel Mount N/A
 Poles 7
 Temperature Range - Operating -20°C to +105°C
 Wire Size AWG 16
 Wire/Cable Type UL 1015

Electrical

Current - Maximum per Contact 8.0A
 Voltage - Maximum 600V AC/DC

Material Info

Engineering Number 2R7004A20F060

Reference - Drawing Numbers

Sales Drawing SD-130014-006, SD-130014-009

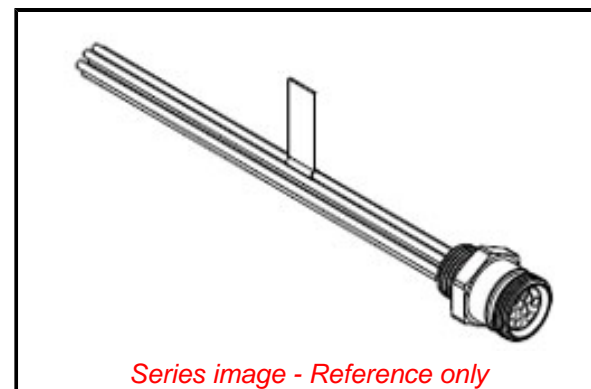

Series image - Reference only

EU ELV

Not Relevant

EU RoHS

Not Reviewed

REACH SVHC

Not Reviewed

Halogen-Free

Status

Not Reviewed

Need more information on product environmental compliance?

Email productcompliance@molex.com
 Please visit the [Contact Us](#) section for any non-product compliance questions.

China ROHS	Not Reviewed
ELV	Not Relevant
RoHS Phthalates	Not Reviewed

China RoHS

Search Parts in this Series
[130014 Series](#)