



# The perfect mix of performance and smarts

BradyPrinter i5100 Industrial Label Printer

# The perfect mix of performance and smarts

When you're looking for a printer with the fundamental printing capabilities for the work you need to get done every day, look no further than the BradyPrinter i5100 Industrial Label Printer. You'll get the perfect combination of high-volume performance and smart printing technology to make high-mix printing easier throughout your facility.

It's easy to see how the i5100 printer makes industrial printing easier with:

**Simple setting changes:** The intuitive touchscreen allows you to quickly and easily change settings on your printer.

**Full-performance printing:** This printer provides all the essential features you need for high-performance printing.

**Intelligent Print (IP) technology:** Take the guesswork out of material changeovers and set up with materials and software that communicate with the printer so you can get back to work faster.

**Smart loading design:** Changing out materials is fast and easy with the specially designed ribbon spindles, and auto-centering roll holders that lock into place without any clumsy extra steps.

**Hardware options:** You'll get a variety of connection ports to stay connected any way you need to and you'll get interchangeable rollers to optimize printing on a variety of material widths.

## The complete BradyPrinter i5100 solution



# BradyPrinter i5100

INDUSTRIAL LABEL PRINTER

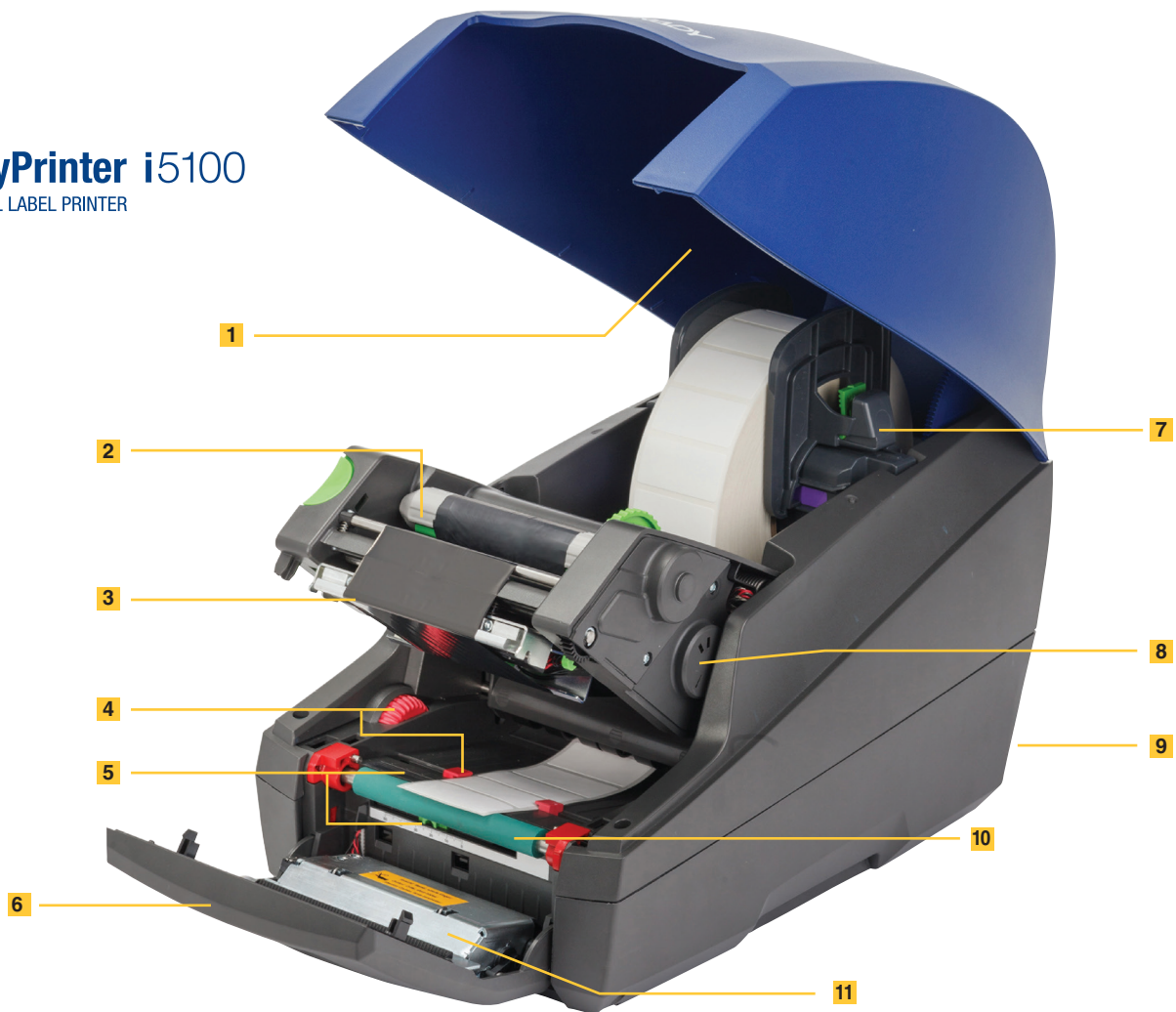

**1 Top-loading design**

Reduces footprint in your workspace and simplifies media alignment and loading

**2 Ribbon takeup spindle**

Both spindles are keyed for guaranteed correct ink-side orientation and slip quickly into place with no complicated ribbon thread-through, no axles to loosen or tighten and no separate cardboard core needed

**3 Print head**

300 or 600 dpi print heads are interchangeable through the Brady service department so you can change your print resolution if your needs change

**4 Media guide adjustment (center-aligned media)**

A simple turn of the dial auto-centers the media guides from 5.1 mm to 114 mm widths

**5 Sensors**

Both the gap and notch sensors are easy to adjust, and with IP-enabled media rolls, sensors are auto-detected and the correct settings are displayed for the user

**6 Color touchscreen control panel**

Icons and sliders for easy printer setting adjustments and information about parts when using Brady IP-enabled rolls

**7 Roll holder with label part detection**

Printer auto-detects IP-enabled label rolls to communicate part set up information to both printer and Brady software. Holds 3 in. core roll

**8 Ribbon cog with ribbon part detection**

Printer auto-detects IP-enabled ribbon part and communicates ribbon information to the user and warns if the incorrect ribbon is used

**9 Interface options**

2x USB, USB 2.0, RS-232C, Ethernet and SD card (back of printer)

**10 Print roller**

Green synthetic rubber rollers available in 4 widths and can be replaced by the user if worn, or to pair a narrow roller with narrow media

**11 Integrated auto-cutter (optional model)**

Built-in cutter for complete cut through of approved media

## Quickly and easily change printer settings

Make changes quickly and easily on the BradyPrinter i5100 with its intuitive touchscreen. Colorful icons, buttons and sliders allow you to navigate between screens, make printer setting changes and view the printer status with ease. The easy-to-use interface also includes responsive prompts and embedded how-to videos.

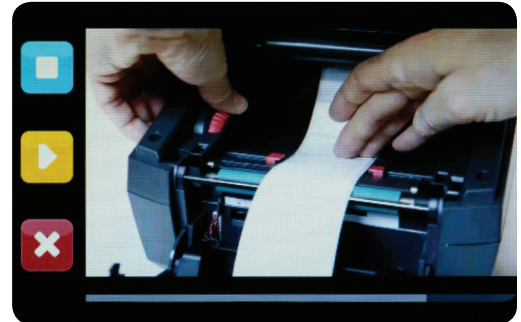
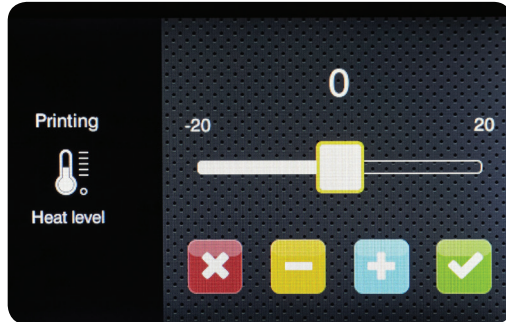
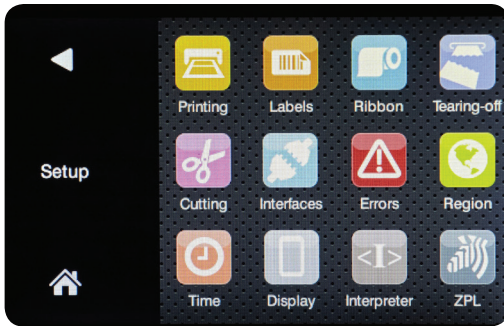

## Full-performance printing from start to finish

With the fundamental printing capabilities you need to get the job done, this printer will be your high-volume, high-mix workhorse on the most common industrial materials. This printer has robust processing power to handle the high-volume jobs you send to it, and can print on labels as small as 0.20 inches.

Also compatible with Brady Workstation and LabelMark™ label creation software from Brady, this printer makes label creation easy and hassle-free.



## Intelligent printing technology means faster, easier set up

IP-enabled supplies from Brady allow the printer, labels, ribbons and software to work together for efficient label set up and creation. It's all in the IP-enabled RFID tag embedded in our materials – it stores the material size, type, color, quantity and compatibility. When installed, the tag sends that information to the printer and software, and displays it on screen to provide you with a variety of time- and cost-saving benefits, including:

- Supplies remaining gauge
- Auto sensor select
- Auto-part set up in software
- Auto print speed and heat setting
- Ribbon incompatibility warning

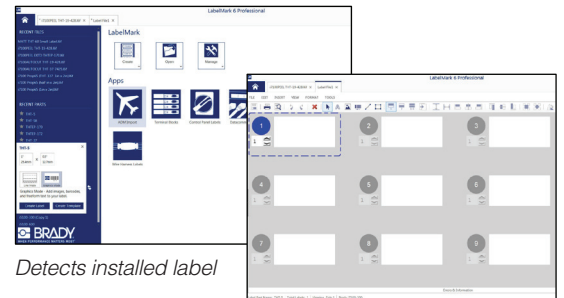
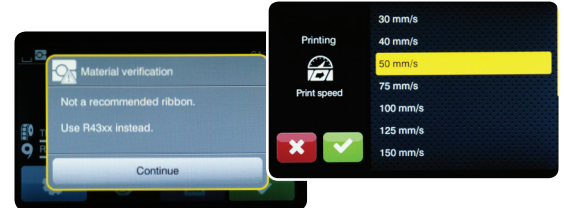
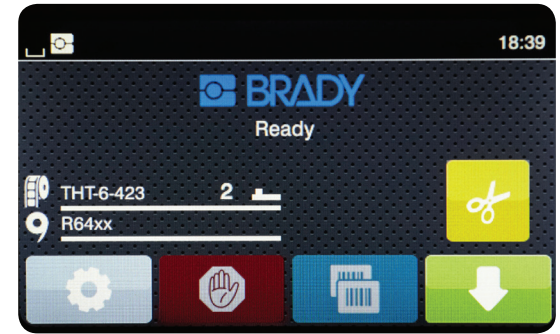

User just enters label content

## Smart design for fast material changeovers

The specially designed ribbon spindles and roll holder simplify the clumsy loading process of traditional materials. The media rolls easily drop into place quickly and always in the correct orientation. This feature makes this printer ideal for facilities that use a variety of materials throughout the day.



## Reduce print head wear with variable roller widths

To keep your printer running smoothly and to avoid unnecessary costs, the BradyPrinter i5100 has rollers available in a variety of widths that can be quickly changed out and replaced to improve print head life. These rollers are designed to be used with materials that are similar widths to help reduce wear on the print head.



## Connect with confidence

The i5100 provides a diverse set of connection ports on the back of the printer, allowing you to connect common devices to the printer.



- 1 SD memory card slot
- 2 2 x USB host ports (for memory stick, scanner, keyboard, BT adapter, WLAN stick and service key)
- 3 USB 2.0 Hi-speed device port for PC connection
- 4 Ethernet 10/100 BASE-T port
- 5 RS232C Interface 1.200 to 230.400 baud/8 bit
- 6 WLAN hotspot or infrastructure mode (in hotspot mode it is possible to directly connect a mobile device to the printer via WLAN)







# BradyPrinter i5100 printers and accessories

## Printers

Printers ship ready to use with 1 auto-detect media roll holder, 1 ribbon takeup spindle, power cord, USB cable, user manual, user license for Brady Workstation PWID Software suite, and a CD that contains drivers, user manual in 24 languages and configuration manual.





	Catalog #	Description	Details
	149452	i5100 Industrial Label Printer, Standard Version, 300 dpi	Prints on labels, tags and select continuous media wound on rolls or fanfolded. Media is torn off after printing using tear bar that is standard on printer.
	149455	i5100 Industrial Label Printer, Standard Version, 600 dpi	Prints on labels, tags and select continuous media wound on rolls or fanfolded. Media is torn off after printing using tear bar that is standard on printer. 600 dpi head is ideal for smaller fonts, intricate graphics and bar coding, including 2D codes.
	149453	i5100 Industrial Label Printer, Auto Cutter Version, 300 dpi	In addition to the capabilities of standard model, this configuration has a built-in auto cutter and tear bar to allow for tear-off or complete cut-through printing. Cutting is limited to cuttable materials at down-web label lengths of 12 mm or greater.
	149456	i5100 Industrial Label Printer, Auto Cutter Version, 600 dpi	In addition to the capabilities of standard model, this configuration has a built-in auto cutter and tear bar to allow for tear-off or complete cut-through printing. Cutting is limited to cuttable materials at down-web label lengths of 12 mm or greater. 600 dpi head is ideal for smaller fonts, intricate graphics and bar coding, including 2D codes.

## Accessories

	Catalog #	Description	Details
	149470	Spare i5100/IP Media Roll Holder, Auto-detect	Holds 3 in. open core media rolls and auto-detects Brady IP-enabled media rolls. Separates and slides back together easily for fast self-centering installation of media roll. Also fits Brady IP-model printers.
	149562	Spare i5100/IP Ribbon Takeup Spindle	Features flexible green tab for faster ribbon threading and a quick-release lever for removing used ribbon from spindle. When using this spindle, no separate cardboard ribbon core is needed. Also fits Brady IP-model printers.
	149131	USB WLAN Stick	2.4 GHz 802.11b/g/n + 5 GHz a/n/ac with rod antenna for extended reach.
	149080	USB Bluetooth Adapter	USB Bluetooth adapter.
	149563	RS232 Cable	Connecting cable RS232 C 9/9 pin, 3 m length.

## Replaceable print rollers

Minimize wear on the print head by pairing narrow rollers with narrow media — always be sure the roller is wider than the label media and the ribbon is wider than the roller.

	Catalog #	Description	Details
	149471	Print Roller 120 mm	For media up to 119 mm wide. Use ribbon that is at least 121 mm wide.
	149598	Print Roller 80 mm	For media up to 79 mm wide. Use ribbon that is at least 81 mm wide.
	149473	Print Roller 50 mm	For media up to 49 mm wide. Use ribbon that is at least 51 mm wide.
	149472	Print Roller 25 mm	For media up to 24 mm wide. Use ribbon that is at least 26 mm wide.
	PCK-6	IPA Printer Cleaning Swabs	Pre-soaked in IPA, lint-free synthetic cleaning swabs for cleaning rollers, print heads and sensors. Package of 50 individually wrapped swabs.

# The right label from the right company

Nothing leaves Brady's doors without meeting the highest quality standards. Backed by more than 100 years of identification experience and rigorous R&D testing, Brady manufactures materials you can trust.

The BradyPrinter i5100 offers more than 100 label materials, more than 3,000 stock label parts and made-to-spec custom materials and parts that can be used in a variety of applications, including:



## Product ID and production line applications



- Metallized labels and rating plates
- Work-in-process labels
- QA testing labels
- Repositionable labels
- Tamper-evident and tamper-resistant labels
- Barcode labels
- Product labels
- Destructible labels

## Electronics and PC board applications

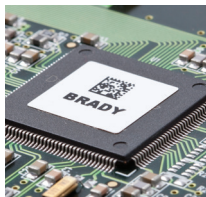
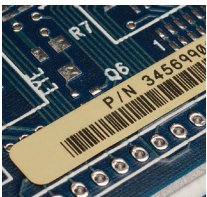

- Polyimide labels
- Removable polyimide labels
- Electrostatic dissipative labels
- PC board component labels
- Polyester labels

## Logistics, general industrial and asset ID applications



- Paper labels
- Tag stock
- Asset tracking labels
- Repositionable labels
- Tamper-evident and tamper-resistant labels
- Polyester labels
- Bin and shelf labels
- Tote and pallet labels

## Electrical and automation applications

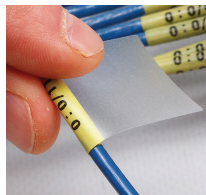

- Adhesive wire label wraps
- Push button / engraved plate alternative labels
- Self-laminating wire markers
- Panel rating plate materials
- Heat-shrink wire sleeves
- General purpose labels
- Inside panel labels
- Arc flash panel labels
- Cable tags

## Laboratory and sample tracking applications



- Tube and vial labels
- Labels for humidity, moisture, water bath and autoclave
- Cryo labels
- Dish, tray and well plate labels
- Slide labels / solvent-resistant labels
- Tissue cassette labels and applicators
- Removable labels for glassware
- General lab equipment labels



# i5100 print ribbons

IP-enabled ribbons from Brady are designed to guarantee correct ink-facing orientation every time, which prevents damage to your print head and allows you to load ribbons quickly, and get back to work.

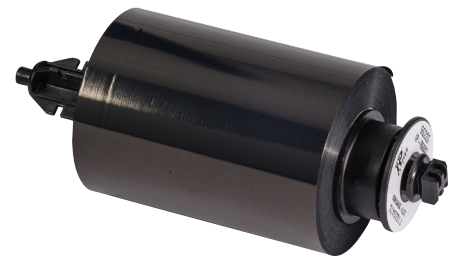

Ribbon Series Description	Catalog #	Size (in. x ft.)	Color
<b>R4300 Wax/Resin</b> Strong environmental resistance against smearing and chemicals. Also, reliable, sharp-edge print quality to maximize barcode readability.	IP-R4306	1.570 x 984	Black
	IP-R4302	2.360 x 984	Black
	IP-R4300	3.270 x 984	Black
	IP-R4307	4.330 x 984	Black
<b>R4400 Resin</b> High density, excellent solvent resistance, high heat resistance, scratch resistance.	IP-R4400-WT	2.360 x 984	White
	IP-R4402-WT	3.270 x 984	White
	IP-R4407-WT	4.330 x 984	White
	IP-R4400-GR*	2.360 x 984	Green
	IP-R4402-GR*	3.270 x 984	Green
	IP-R4400-RD*	2.360 x 984	Red
	IP-R4402-RD*	3.270 x 984	Red
	IP-R4407-RD*	4.330 x 984	Red
	IP-R4400-BL*	2.360 x 984	Blue
	IP-R4402-BL*	3.270 x 984	Blue
IP-R4407-BL*	4.330 x 984	Blue	
<b>R4500 Wax/Resin</b> Strong environmental resistance against smearing and chemicals. Also, reliable, sharp-edge print quality to maximize barcode readability.	IP-R4500-RD	2.360 x 984	Red
	IP-R4502-RD	3.270 x 984	Red
	IP-R4507-RD	4.330 x 984	Red
	IP-R4502-SV	3.270 x 984	Silver
	IP-R4500-BL	2.360 x 984	Blue
	IP-R4502-BL	3.270 x 984	Blue
IP-R4507-BL	4.330 x 984	Blue	
<b>R4900 Resin</b> Superb smear resistance at high temps. Superior solvent resistance.	IP-R4902	2.360 x 984	Black
	IP-R4900	3.270 x 984	Black
<b>R6000 Resin</b> Halogen-free, high density, excellent solvent resistance, high heat resistance, scratch resistance.	IP-R6006	1.570 x 984	Black
	IP-R6000	2.360 x 984	Black
	IP-R6002	3.270 x 984	Black
	IP-R6007	4.330 x 984	Black
<b>R6100 Wax/Resin</b> Outstanding durability for a general purpose ribbon. Reduced printhead energy requirements.	IP-R6100	2.360 x 984	Black
	IP-R6102	3.270 x 984	Black
	IP-R6107	4.330 x 984	Black
<b>R6200 Resin</b> Designed for harsh environment labeling applications. Superior abrasion, chemical and heat resistance.	IP-R6206	1.570 x 984	Black
	IP-R6200	2.360 x 984	Black
	IP-R6202	3.270 x 984	Black
	IP-R6207	4.330 x 984	Black
<b>R6400 Resin</b> High density, excellent solvent resistance, high heat resistance, scratch resistance.	IP-R6406	1.570 x 984	Black
	IP-R6400	2.360 x 984	Black
	IP-R6402	3.270 x 984	Black
	IP-R6407	4.330 x 984	Black
<b>R6600 Resin</b> Diesel resistant for printing on Brady PermaSleeve® and Heatex™ Sleeves.	IP-R6600	2.360 x 984	Black
	IP-R6602	3.270 x 984	Black
	IP-R6607	4.330 x 984	Black
<b>R6700 Wax/Resin</b> High performance against scratching, smudging and harsh chemicals.	IP-R6700-WT	2.360 x 984	White
	IP-R6702-WT	3.270 x 984	White
	IP-R6707-WT	4.330 x 984	White
<b>R6800 Resin</b> Specialized white ribbon for use with dark-colored PermaSleeve HT markers.	IP-R6800-WT	2.360 x 984	White
	IP-R6800-WT	3.270 x 984	White
	IP-R6807-WT	4.330 x 984	White
Spare Brady ribbon takeup spindle	149562	—	—
Non-IP-enabled ribbon spindle	108231	—	—

\* ⚠ Warning: Reproductive Harm [www.P65Warnings.ca.gov](http://www.P65Warnings.ca.gov)

# Software for easier label creation

Brady is an innovator of intuitive software to make label creation even easier and more efficient. These software options are designed to guide you through the label creation process to minimize errors and make label creation simple.



## Brady Workstation Label Creation Software

Brady Workstation revolutionizes label and sign creation and printing by offering a variety of suites and apps that are easy and efficient to use. Choose and customize the tools you use to complete tasks exactly as you want.

### Included with i5100 printer:



**Product and Wire ID Suite** – This suite allows you to create wire and panel ID labels, basic text labels and labels with graphics and custom formatting. You can also serialize and import data in one fast, efficient process.

### Other apps and suites are available:



1. Go to [Workstation.BradyID.com](http://Workstation.BradyID.com)



2. Fill the workstation with the apps and suites you want and leave out the ones you don't.

For more information on Brady Workstation apps and suites, go to [Workstation.BradyID.com](http://Workstation.BradyID.com)

## LabelMark™ 6 Label Creation Software

LabelMark Software from Brady is a robust CD-based software solution for label design, data importation and printing labels for a variety of applications. Print Partner companion software allows you to create and manage print-only files across multiple print stations and sites, and our Data Automation companion software allows you to integrate automated printing within your workplace and third-party systems.



# Printer specifications

<b>Model(s):</b>	
Model name	i5100 Industrial Label Printer
Media alignment	Center justified
<b>User Interface:</b>	
Display type	Touchscreen color LCD
Display size (diagonal)	4.3 in.
Display resolution (h x w)	272 x 480 pixels
Display languages	Arabic (Egypt), Bulgarian, Chinese (simplified), Croatian, Czech, Danish, Dutch, English, Finnish, French, German, Greek, Hungarian, Italian, Korean, Lithuanian, Macedonian, Norwegian, Persian (Farsi), Polish, Portuguese, Romanian, Russian, Serbian, Slovenian, Spanish (Castilian), Spanish (Mexico Latin Amer), Swedish, Thai, Turkish
Display status bar	Brady mode or standard mode, ribbon and label part number installed, amount of supplies remaining, sensor activated, where to set sensor, receiving data, record data stream, ribbon warning, Bluetooth, WLAN, Ethernet, USB slave, time, presence of SD card and USB stick
<b>Print Head / Printing Characteristics:</b>	
Print resolution	300 dpi 600 dpi
Print method	Thermal transfer (300 or 600 dpi) Direct thermal (300 dpi - material & printhead dependent)
Print color capability	Single print color
Print speed	Up to 11.8 in/sec (300 dpi) Up to 5.9 in/sec (600 dpi)
Print width (max, cross-web)	4.16 in.
Print length (max, down-web)	6.6 ft.
Media cut-off	Tear bar, optional auto-cutter model
<b>Media Characteristics:</b>	
IP-enabled printing	Yes - reads IP-enabled supplies for Brady mode printing
Media width (cross-web incl liner)	0.24 to 3.35 in. (continuous sleeves) 0.36 to 4.40 in. (other materials)
Label width (cross-web)	0.20 to 4.33 in.
Label length (down-web)**	0.20 in. minimum (w/no backfeed) 0.50 in. minimum (w/backfeed) 0.47 in. minimum (if cutting single label)
Media thickness	0.0024 in. to 0.029 in. (label materials) 0.070 in. max (push button labels) 0.043 in. max (heat shrink sleeves)
Media roll o.d. (max)	8.07 in.
Media roll core i.d.	3.0 to 3.94 in.
Media roll winding	Outside or inside
Internal rewind takeup roll o.d. (max)	n/a
Internal rewind takeup roll core i.d.	n/a
Internal rewind takeup roll winding	n/a
Media styles	Die cut media, continuous media, 3 in. core roll-fed media, fanfolded media (external feed), tagstock liner-mounted, tagstock linerless, perforated materials, adhesive labels, heat-shrink sleeves size 125 and larger (single sided), continuous sleeves size 125 and larger externally fed, self-laminating cable labels, raised panel push button labels (with no backfeed or autocut), rapido-style cable tags, Permashield style labels
Media material types****	IP-enabled media and ribbon rolls (for Brady mode printing), PE (polyethylene), PET (polyester), PET Metallized, PU (polyurethane), PVC (vinyl), PVF (polyvinyl fluoride), PVDF (polyvinylidene fluoride), PP (polypropylene), PI (polyimide), polyamide, polyether polyurethane (Heatex™), raised panel push button material, paper, destructible materials, tamper-evident and tamper-resistant materials, other materials not listed
Media parts offering	2900+ stock parts and custom (made-to-spec) parts
<b>Ribbon Characteristics:</b>	
Ribbon length (max)	1000 ft.
Ribbon roll o.d. (max)	2.74 in.
Ribbon roll core i.d.	No core needed (IP-enabled supplies), otherwise 1.0"
Ribbon width (cross-web)***	1.0 to 4.49 in.
Ink side	Inside or outside wound
<b>Electronics:</b>	
Processor	32 bit 800 MHz clock rate
Memory (RAM)	256 MB
Data storage (IFFS)	50 MB
SD card slot (SDHC, SDXC)	512 GB max
Internal battery	For internal date and time (RTC)
Data storage when power off	Yes

<b>Physical / Operational Characteristics:</b>	
Dimensions (closed) (h x w x d)	12.5 in. x 9.5 in. x 17.1 in.
Weight (empty)	14.6 lbs
Power supply	100 - 240V AC, 50/60 Hz, PFC
Power consumption	<10W standby / 150W typical / 300W max
Operating environment	0 - 40°C / 10 - 85% RH non condensing
Storage environment	0 - 60°C / 20 - 85% RH non condensing
Transport environment	-25 - 60°C / 20 - 85% RH non condensing
Agency approvals	CE, FCC class A, cUL. Contact Brady for up-to-date list of environmental compliance information and agency approvals and/or marks covering over 75 countries (awarded or applied for)
<b>Fonts and Graphics:</b>	
Font types (resident)	6 bitmap fonts - including OCR-A, OCR-B 3 vector fonts - Swiss 721, Swiss bold 721, Monospace 821
Font types (storable to printer)	TrueType fonts storable to printer via jump drive
Font attributes	Bold, italic, underlined, outline, negative depending on font
Font scaling (bitmap)	Width & height range: 0.039 to 0.12 in. Zoom factor: settings 2 to 10 rotation: 0°, 90°, 180°, 270°
Font scaling (vector & truetype)	Width and height range: 0.35 to 5.04 in. Zoom factor: variable (dot-by-dot) rotation: 360° in steps of 1°
Character sets	Windows 1250 up to 1257, DOS 437,737,755,85 0,852,857,862,864,866,869, EBC DIC 500, ISO 8859-1 to-10 and -13 to -16, Win OEM 720, UTF8, Macintosh, Roman, DEC MCS, KO18-R, All West and East European characters and Latin, Cyrillic, Greek, Hebrew, Arabic, simplified Chinese, and Thai characters are supported
Graphic elements	Arrows, lines, rectangles, circles, ellipses; filled and filled with fading
Graphic formats	PCX, IMG, BMP, TIF, MAC, PNG
<b>Barcodes:</b>	
Barcode symbologies - linear	Code 39, Code 39 Full ASCII, Code 93, Code 128 A, B, C, Codabar, Deutsche Post (indent- and routing), EAN 8, 13, EAN/UCC 128/GS1-128, EAN/UPC Appdx 2 and Appdx 5, FIM, HIBC, Interleaved 2/5, JAN 8, 13, MSI, Plessey, Postnet, RSS 14, UPC A, E, E0
Barcode symbologies - 2D	Aztec, DataMatrix, QR Code, PDF 417, UPS MaxiCode, GS1 Databar, Codablock F, Micro PDF 17, RSS 14 (truncated, limited, stacked, stacked omni-dir), EAN/GS1 DataMatrix
Barcode attributes	Sizing: variable in height, modular width and ratio Rotation: 0°, 90°, 180°, 270°
<b>Interfaces and Connection:</b>	
USB 2.0 hi-speed device port	For PC connect
2 x USB host (back panel)	For scanner, keyboard, USB memory stick, USB bluetooth adapter, USB WLAN stick w/antenna
1 x RS232-C	For serial cable connection. 1,200 - 230,400 baud/8 bit
1 x Ethernet 10/100 BASE-T	For networking, remote access, and firmware updates
1 x SD slot	For memory card (SDHC, SDXC)
<b>Software and Firmware:</b>	
Label creation software	Brady Workstation (v4.1 or newer) Brady LabelMark Software (v6.6.1 or newer)
WHQL certified Windows® drivers****	Windows 7, 8, 8.1, 10, Server 2008, 2008 R2, 2012, 2012 R2, 2016
Printer command language	Jscript - scripting commands for sending scripts to the printer
Printer compiler language	abc basic - for placing embedded logic programming and prompts onto the printer
Printer administration / monitoring	Web-based remote access - allows printer control, configuration, firmware updates, memory card admin and time/date synchronization, and will send printer status, and error messages to users
Open source software	Go to <a href="http://www.BradyID.com/i5100compliance">www.BradyID.com/i5100compliance</a> for a list of open source software files used in this product
<b>Options / Accessories:</b>	
Replacement print heads	Factory installed via Brady tech repair
Replacement print rollers***	Variable widths to protect print head with narrow supplies - field installable
Auto cutter	Optional auto cutter model

\*\* User should test to the application. Print performance on small labels or a part that is below the minimum label dimension spec. is dependent on multiple factors, including print speed, qty in print run, heat setting and the size/layout of the printed elements.

\*\*\* Use narrow print roller with narrow media, but to avoid head damage, ALWAYS be sure roller is wider than total media width, and ribbon is wider than the roller width.

\*\*\*\* Windows® is a registered trademark of Microsoft Corporation.

## Support you can rely on

Feel confident that your BradyPrinter i5100 is covered by our 5-year benchtop printer warranty. You'll benefit from our staff of support and repair technicians for troubleshooting support, set-up assistance and how-to guidance and repair services.

Visit [BradyID.com/Brady360](http://BradyID.com/Brady360) for full warranty coverage details.

## Custom solutions for your custom needs

If you need assistance with advanced integration of your i5100 into a complex data flow scenario, the Application Engineering Services Team may be able to help. This team specializes in customized, fee-based services that include:

- Complex scenarios of printer, software and label integration
- Custom programming
- File conversions
- Template creation
- Scan-to-print mapping
- Data flow integration from database to printer

USA  
Customer Service: 1-888-272-3946  
Inside Sales: 1-888-311-0775  
[BradyID.com](http://BradyID.com)

Canada  
Customer Service: 1-800-263-6179  
[BradyCanada.ca](http://BradyCanada.ca)

Mexico  
Customer Service: 1-800-262-7777  
Inside Sales: 1-800-262-7777 ext 177  
[BradyLatinAmerica.com](http://BradyLatinAmerica.com)



Y4648106 MS4648106