

Carlton®

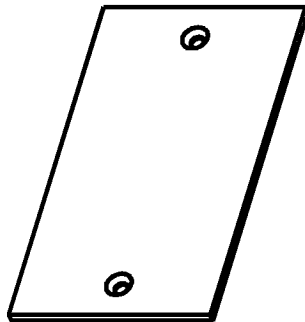

BLANK
PLATE

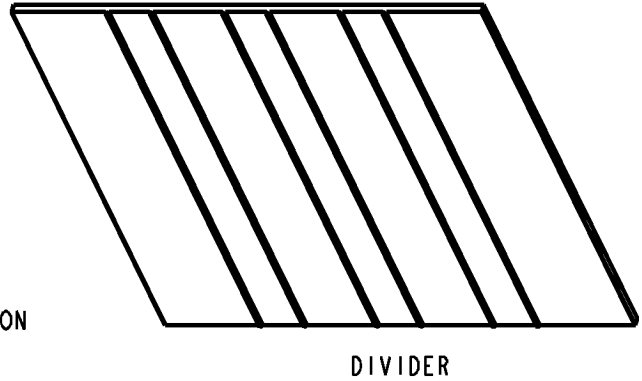
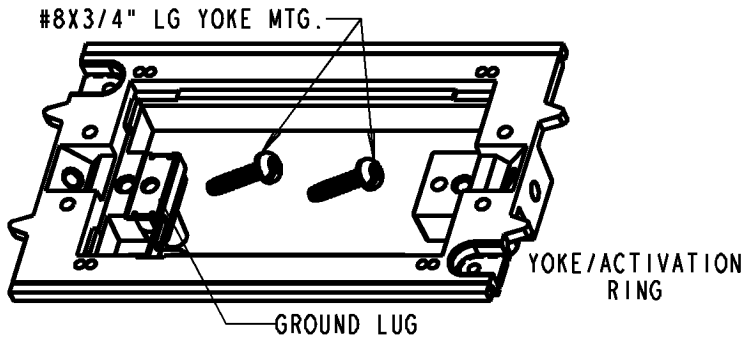
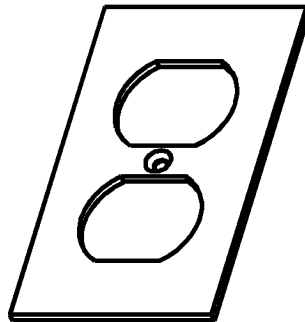

DUPLEX
PLATE

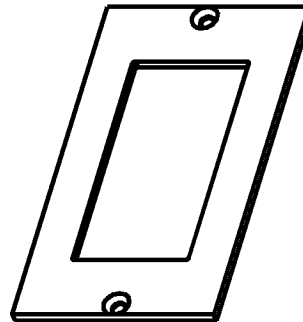

GFCI
PLATE

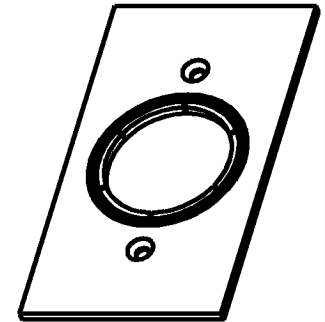

SINGLE RECEPTACLE
PLATE

#6X5/8" LG PLATE MTG. SCREWS PROVIDED



GASKET FOR METALIC COVERS

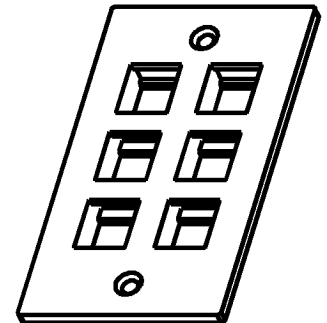

LOW VOLTAGE
INSERT PLATE

QTY	DESCRIPTION
X	P/N E976AK2
1	YOKE/ACTIVATION RING
1	DIVIDER
1	GASKET, COMPETITIVE COVERS
1	HARDWARE KIT (P/N KE976SK)
1	BLANK PLATE
1	DUPLEX PLATE
1	GFCI PLATE
1	SINGLE RECEPTACLE PLATE
1	LOW VOLTAGE PLATE (6 PORTS)

- NOTES:
 1. COLOR: GRAY (WHERE APPLICABLE)
 2. U.S. PATENT 5,866,845

GENERAL NOTES

- ALL DIMENSIONS ARE FOR REFERENCE ONLY.
- DIMENSIONS IN BRACKETS [] ARE IN METRIC UNITS.

REVISIONS

SEE ERN (****) FOR APPROVAL SIGNATURES & RELEASE DATE.
 PROJECT NO: ****

Thomas & Betts
 www.tnb.com

DESCRIPTION: **MODULAR RECTANGULAR FLOORBOX ADAPTER KIT**

ORIGINAL PROJECT NO / (ERN NO)

/ ()

SHEET NO:

1 OF 1

REV. NO:

E

DRAWING NO:

WSD-AC02828