

Floodlight brackets for steel and wood poles.

Color: Galvanized

Weight: 8.2 lbs

Project:

Type:

Prepared By:

Date:

Technical Specifications

Construction

Finish:

Galvanized steel

EPA Maximum Capacity:

7.4

Bracket:

3/16" thick steel

Other

Description:

Single Floodlight Bracket

Maximum Weight:

105 lbs

Patents:

The designs of fixtures are protected under U.S. and international intellectual property laws.

Buy American Act Compliance:

RAB values USA manufacturing! Upon request, RAB may be able to manufacture this product to be compliant with the Buy American Act (BAA). Please contact customer service to request a quote for the product to be made BAA compliant.

Dimensions

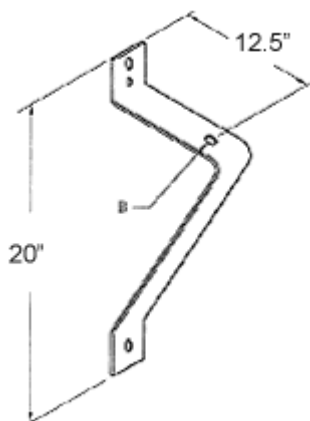

Features

- Easy, secure floodlight mounting
- Double Reinforced weld joints