

Twist-Lock® Devices
 30A, 3 Phase Y 277/480V AC, 4 Pole, 4 Wire
 Non-Grounding
 Insulgrip® Flanged Receptacle

HUBBELL

Features

- Impact resistant thermoplastic construction
- Backwired terminations for ease of installation
- #10-32 Multiple drive terminal screws (Slotted, Phillips, Robertson)
- Mounting screws included



20A 3ØV
 277/480V AC
 NEMA L19-20R
 UL Listed
 5 HP



Ordering Information

Description	Device Color	UPC	Catalog Number
Nylon casing, back wired.	White	783585039503	HBL2766

Listings

Listed to UL 498
 Fed.Spec. W-C-596
 Certified to CSA C22.2 No.42

Specifications

Housing	Nylon
Terminal Retainer	Clear polycarbonate
Contacts	Brass
Terminal Screws	#10-32 Brass (Phillips / Slotted / Robertson)
Terminal Clamp	Cold rolled steel – nickel plated
Assembly Screws	Steel - nickel plated
Mounting Screw	Nickel plated brass

Performance

Electrical

Current Interrupting	Certified for current interrupting at full rated current
Dielectric Voltage	Withstands 2,000V minimum

Mechanical

Terminal Accommodation	#16 AWG - #8 AWG solid or stranded copper wire only.
Terminal Identification	Terminals identified in accordance with UL 498

Environmental

Flammability	V2 or better per UL94/CSA 22.2 No.0.17
Moisture Resistance	IP20 Suitability
Operating Temperatures	Maximum Continuous 75°C; Minimum -40°C (w/o impact)

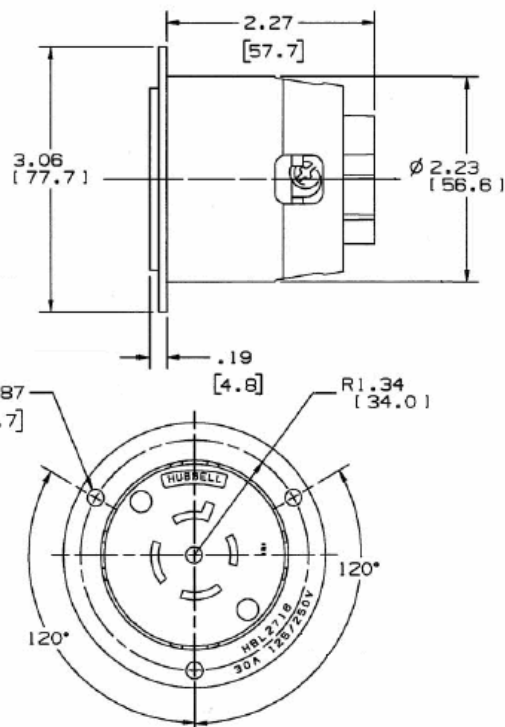

Accessories

Plug	HBL2761
Weatherproof Lift Cover	WP2

Resources

Customer Use Drawing
 eCatalog

Dimensions in Inches (mm)

Hubbell Wiring Device-Kellems • Hubbell Incorporated (Delaware) • 40 Waterview Drive • Shelton, CT 06484

Phone (800) 288-6000 • Fax (800) 255-1031 • Specifications subject to change without notice.

