

## NET SERIES COMMUNICATION AND SERVER CABINET



- Rack angle settings on all 700- and 800-mm wide cabinets can accommodate either 19- or 23-in. rack spacing
- In 600-mm wide cabinets, equipment mounted on 19-in. rack angles is centered
- In 700- and 800-mm wide cabinets, 19-in. rack angles can be set to center equipment or to mount equipment next to the left or the right side for improved cable management
- Rack angles infinitely positionable within the cabinet for easy adjustment to desired position
- All doors are field removable and reversible with left or right hinging for installation flexibility
- Communication cabinet has fully perforated or window front and louvered rear doors for equipment ventilation
- Server cabinet has fully perforated front and split rear perforated doors for easy access to servers
- Doors have key-locking handles that provide security with convenient access for authorized personnel
- Removable side panels with quarter-turn key-locking latch are inset for flush appearance
- Two cable entry ports with caps and grommets on cabinet top for wiring ease
- Fan-ready top with integral finger guard. Order up to two 6-in. fans separately.
- Caster- and leveler-ready open base design. Order casters and levelers separately.

### SPECIFICATIONS

- Some models available with or without sides
- Welded multi-formed steel frame. The top and columns are 16 gauge; base is 14 gauge.
- Multi-formed rigid doors are 14 gauge steel
- Window made of 1/8-in. smoke-tinted acrylic
- Formed solid sides are 14 gauge steel
- Rack angles are 12 gauge steel
- Ground studs provided on doors and covers

### FINISH

Pretreated steel coated with RAL 9005 black textured low-gloss polyester powder paint. Other finishes available—contact Hoffman Customer Service.

### LOAD RATING

1000 lb. (454 kg) per UL 2416 with load evenly distributed in enclosure

**NOTE: UL 2416 requires that the cabinet be tested with a load four times the rating. Contact Hoffman if other loading specifications are required.**

### ACCESSORIES

Net Series Rack Angles  
 Net Series Caster Kit  
 Net Series Leveler Kit  
 Net Series Joining Kit  
 Net Series Tool-less (Snap-in) Blanking Panels for 19-in. Racks  
 Net Series Vertical Tie-Down Cable Manager  
 Net Series Tool-less Shelf

### BULLETIN: DC

### INDUSTRY STANDARDS

UL 2416 Listed (perforated, split perforated and louvered door models only)

EIA 310-D  
 IEC 60529, IP20  
 Perforated door material meets equipment manufacturer ventilation requirements

### APPLICATION

Net Series Cabinets are an economical solution for contractors, small computer rooms, schools or smaller networks that require a general-purpose cabinet to house servers and communication equipment. Multiple sizes, adjustable rack angles and accessories give Net Series Cabinets wide application flexibility.

### FEATURES

- Includes two sets of adjustable L-shaped rack angles for convenient equipment mounting
- Rack angles on communication cabinets have tapped 10-32 holes per EIA standards. Order 10-32 fasteners separately.
- Rack angles on server cabinets have square holes per EIA standards. Order fasteners and cage nuts separately.

Standard Product

Catalog Number	AxBxC in./mm	Description	Rack Units	M in./mm	N in./mm	Rack Angle Holes	Additional Rack Angles
NC1268	49.00 x 23.62 x 33.99 1245 x 600 x 863	Communication Cabinet	23	42.00 1067	14.71 374	Tapped 10-32	NRAT126
NC2178	84.00 x 27.56 x 33.99 2134 x 700 x 863	Communication Cabinet	43	77.00 1956	18.65 474	Tapped 10-32	NRAT217
NC2178NS	84.00 x 27.56 x 33.98 2134 x 700 x 863	Communication Cabinet No Sides	43	77.00 1956	18.65 474	Tapped 10-32	NRAT217
NC2179	84.00 x 27.56 x 37.93 2134 x 700 x 963	Communication Cabinet	43	77.00 1956	18.65 474	Tapped 10-32	NRAT217
NC21710	84.00 x 27.56 x 41.86 2134 x 700 x 1063	Communication Cabinet	43	77.00 1956	18.65 474	Tapped 10-32	NRAT217
NC2188	84.00 x 31.50 x 33.99 2134 x 800 x 863	Communication Cabinet	43	77.00 1956	22.58 574	Tapped 10-32	NRAT218
NC2189	84.00 x 31.50 x 37.93 2134 x 800 x 963	Communication Cabinet	43	77.00 1956	22.58 574	Tapped 10-32	NRAT218
NC21810	84.00 x 31.50 x 41.86 2134 x 800 x 1063	Communication Cabinet	43	77.00 1956	22.58 574	Tapped 10-32	NRAT218
NCW2168	84.00 x 23.62 x 33.99 2134 x 600 x 863	Communication Cabinet, Window Door	43	77.00 1956	14.71 374	Tapped 10-32	NRAT216
NCW2168NS	84.00 x 23.62 x 33.98 2134 x 600 x 863	Communication Cabinet, Window Door No Sides	43	77.00 1956	14.71 374	Tapped 10-32	NRAT216
NCW2178	84.00 x 27.56 x 33.99 2134 x 700 x 863	Communication Cabinet, Window Door	43	77.00 1956	18.65 474	Tapped 10-32	NRAT217
NCW2178NS	84.00 x 27.56 x 33.98 2134 x 700 x 863	Communication Cabinet, Window Door No Sides	43	77.00 1956	18.65 474	Tapped 10-32	NRAT217
NCW2188	84.00 x 31.50 x 33.99 2134 x 800 x 863	Communication Cabinet, Window Door	43	77.00 1956	22.58 574	Tapped 10-32	NRAT218
NS12610	49.00 x 23.62 x 41.86 1245 x 600 x 1063	Server Cabinet	23	42.00 1067	14.71 374	Square	NRAS126
NS2169	84.00 x 23.62 x 37.93 2134 x 600 x 963	Server Cabinet	43	77.00 1956	14.71 374	Square	NRAS216
NS2169NS	84.00 x 23.62 x 37.91 2134 x 600 x 963	Server Cabinet No Sides	43	77.00 1956	14.71 374	Square	NRAS216
NS21610	84.00 x 23.62 x 41.86 2134 x 600 x 1063	Server Cabinet	43	77.00 1956	14.71 374	Square	NRAS216
NS21610NS	84.00 x 23.62 x 41.85 2134 x 600 x 1063	Server Cabinet No Sides	43	77.00 1956	14.71 374	Square	NRAS216
NS21611	84.00 x 23.62 x 45.80 2134 x 600 x 1163	Server Cabinet	43	77.00 1956	14.71 374	Square	NRAS216
NS21612	84.00 x 23.62 x 49.74 2134 x 600 x 1263	Server Cabinet	43	77.00 1956	14.71 374	Square	NRAS216
NS21711	84.00 x 27.56 x 45.80 2134 x 700 x 1163	Server Cabinet	43	77.00 1956	18.65 474	Square	NRAS217
NS21811	84.00 x 31.50 x 45.80 2134 x 800 x 1163	Server Cabinet	43	77.00 1956	22.58 574	Square	NRAS218

Tapped and square hole rack angles of the same size can be used interchangeably in communication and server cabinets. See rack angle table for available rack angles.

Catalog numbers with "NS" at the end have no sides.

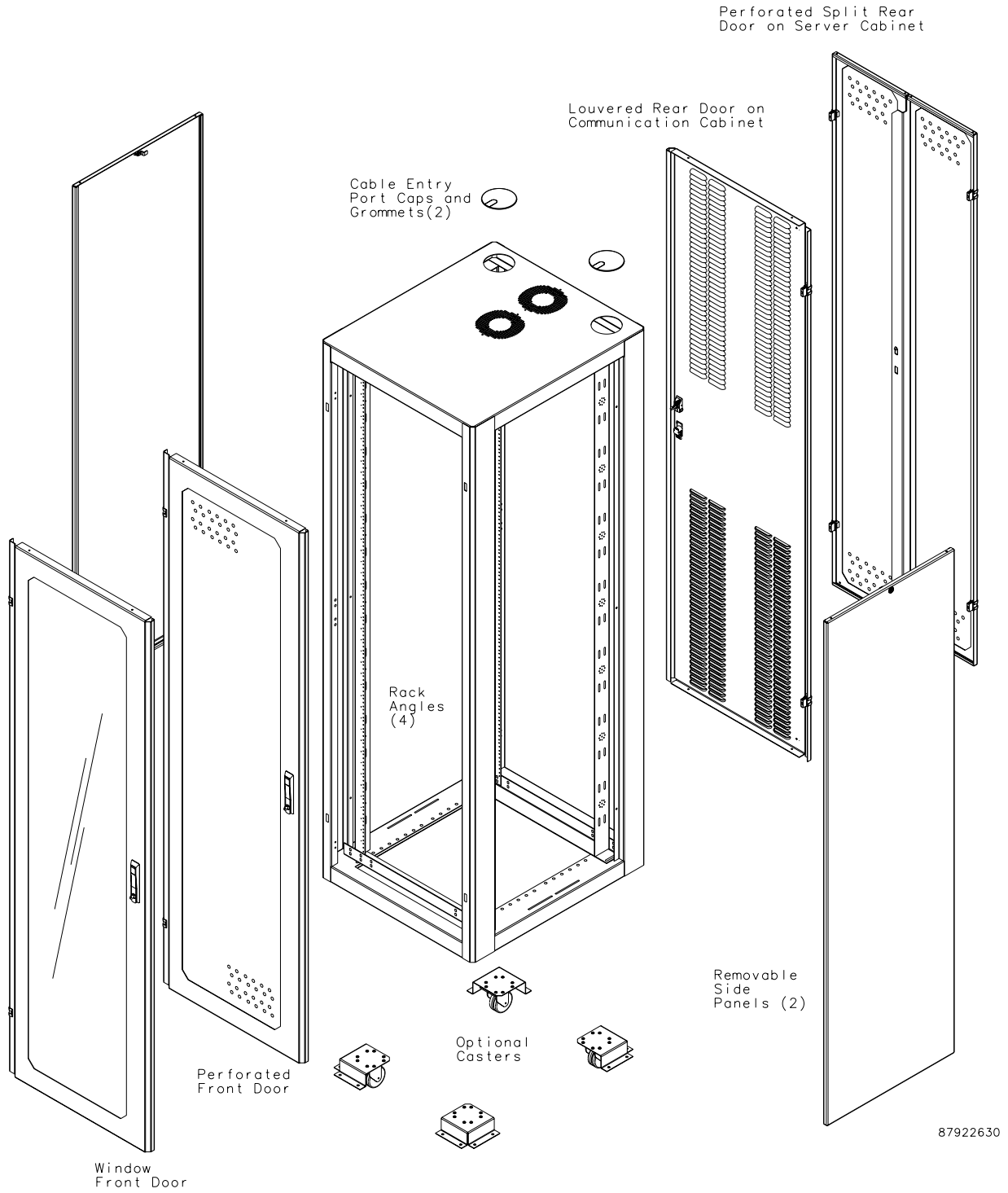

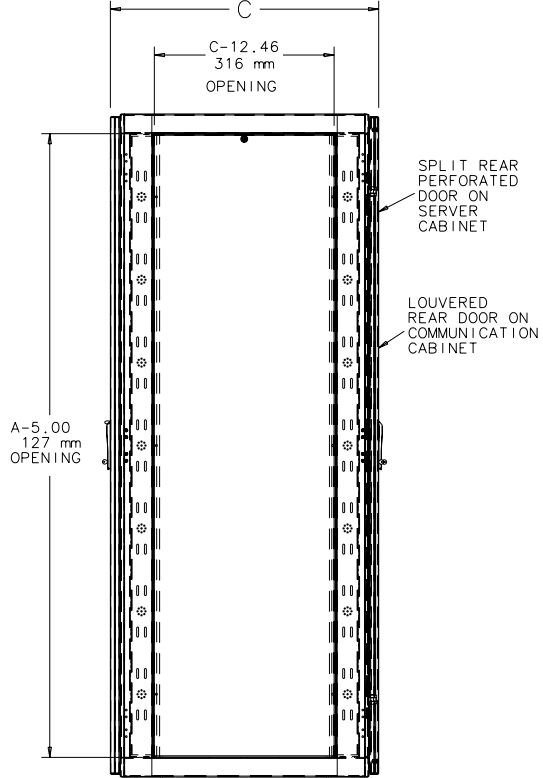
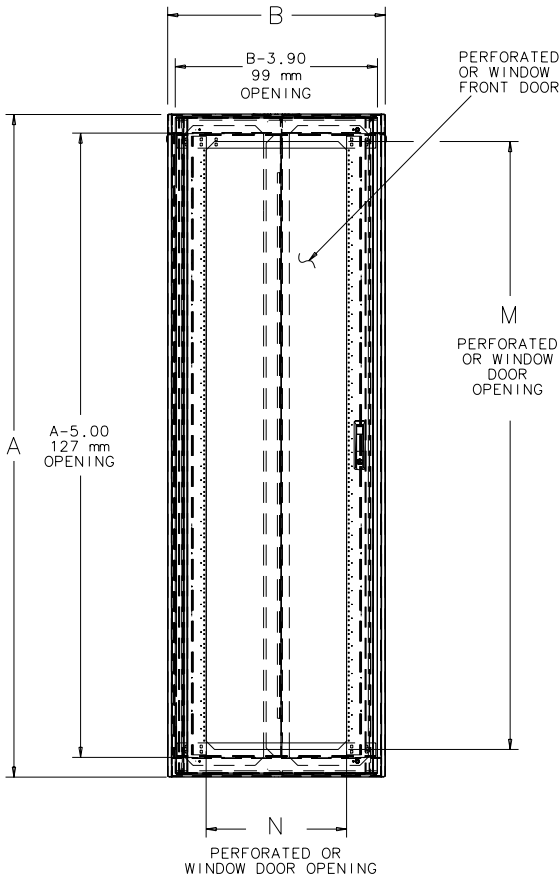
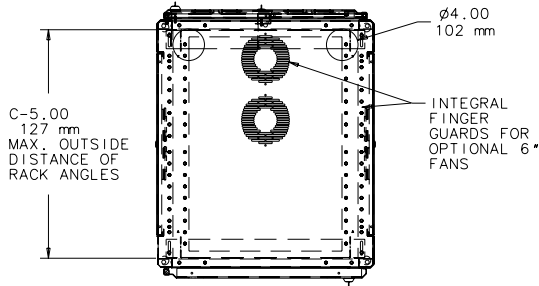

87922631

### NET SERIES RACK ANGLES



Rack angles are available with either 10-32 tapped or square mounting holes. Communication and server cabinets can use either tapped-hole or square-hole rack angles. Finish is RAL 9005 black, low-gloss smooth polyester powder paint. Shipped in sets of two with two mounting brackets and mounting hardware.

**BULLETIN: DCY**

Catalog Number	Length in./mm	Hole Type	Use with Net Series Cabinet H x W
NRAT126	40.37 1025	Tapped	1245 x 600
NRAT216	78.87 2003	Tapped	2134 x 600
NRAT217	78.87 2003	Tapped	2134 x 700
NRAT218	78.87 2003	Tapped	2134 x 800
NRAS126	40.37 1025	Square	1245 x 600
NRAS216	78.87 2003	Square	2134 x 600
NRAS217	78.87 2003	Square	2134 x 700
NRAS218	78.87 2003	Square	2134 x 800

### NET SERIES CASTER KIT



These recessed ball-bearing casters allow Net Series Cabinet repositioning with a minimal effort. Casters add 2 in. to height of cabinet. Kit includes four casters, recessed brackets and mounting hardware.

**BULLETIN: DCY**

Catalog Number	Description
NCK	Set of four casters, recessed brackets and mounting hardware

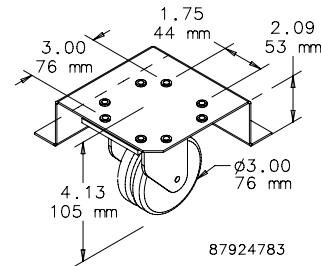

### NET SERIES LEVELER KIT



Leveler Kits allow adjustment of Net Series Cabinets for uneven floors. Can be used with casters to stabilize final installation.

**BULLETIN: DCY**

Catalog Number	Description
NLK	Set of four levelers

### TOOL-LESS (SNAP-IN) BLANKING PANELS FOR 19-IN. RACKS



These Tool-less 19-in. Blanking Panels provide easy tool-less installation and ensure proper airflow to equipment. Made of UL approved thermal plastic material with a low-gloss textured black finish. May be used with tapped or square EIA universal spaced rack mounting angles.

**BULLETIN: DACCY**

Catalog Number	Description	Rack Units	Fits	Pkg. Qty.
D19BPT1RU	Blanking Panel, 19 in.	1	19 in., universal rack spacing, tapped or square holes	10
D19BPT2RU	Blanking Panel, 19 in.	2	19 in., universal rack spacing, tapped or square holes	10

### NET SERIES VERTICAL TIE-DOWN CABLE MANAGER



Hold larger cable bundles securely. VELCRO Cable Wraps provide convenient cable fastening and easy access to individual cables. One piece design. Holes provided for addition of cable transitions, spools, or D-Rings (order separately). Made of steel coated with RAL 9005 black polyester powder paint. Includes mounting hardware.

*VELCRO is a trademark of Velcro Industries B.V.*

**BULLETIN: DCY**

Catalog Number	A in./mm	Fits Cabinet Height
NVCMTD12	40.37 1025	1245
NVCMTD21	78.87 2003	2134

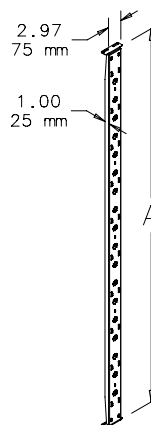

87798903

### D-RING CABLE MANAGERS



D-Rings, made of black plastic, can be used to manage cables horizontally, vertically or as transition occurs. Snap feature allows easy cable access as well as forming a tightly closed connection. Package includes 10 rings and 10 mounting screws.

**BULLETIN: DACCY**

Catalog Number	B1 in./mm	B2 in./mm	L1 in./mm	L2 in./mm	Pkg. Qty.
ECM3DR10	1.72 44	1.22 31	3.50 89	2.88 73	10
ECM6DR10	3.00 76	2.22 56	5.33 135	4.42 112	10

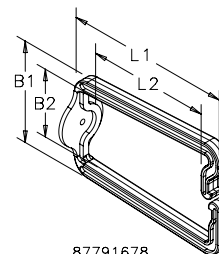

87791678



The PDU Bracket Kit includes two mounting plates and hardware to effectively mount power strips within enclosures.

**BULLETIN: DCY**

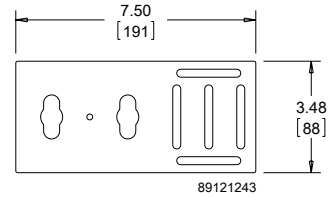

Catalog Number	Finish	Pkg. Qty
DPDU1	Painted black	2

**NET SERIES COMBINATION L-HANDLE**



Combination L-Handle fits Net Series cabinet doors. The 4-digit combination lock with master key override can easily be changed. Install using existing cam from standard handle.

**BULLETIN: DCY**

Catalog Number	AxBxC in./mm	Description	Use With
NCLH	7.50 x 1.38 x 2.50 191 x 35 x 64	L-Handle with combination lock and master key override	Net Series doors

**6-INCH COMPACT AXIAL FANS**



Compact Cooling Fans are ideal for applications where enclosure space is limited and quiet, reliable cooling is required. Engineered for 50,000 hours of continuous operation without lubrication or service.

**BULLETIN: D85**

Standard Product and Cutout Dimensions

Catalog Number	Nominal Size	Voltage
A6AXFNGQ	6	115 VAC
A6AXFNPG	6	115 VAC

**FAN FILTER AND FINGER GUARD KIT**



Low-density filter kit for 4-in. (102-mm) and 6-in. (152-mm) fans. Can also be used as vent. Filter is removable and can be cleaned and reused. Mounting hardware included.

**BULLETIN: DTHRM**

Standard Product

Catalog Number	Fits
AFLTR6LD	6-in. fans

### TOOL-LESS SHELF



An easy-to-install tool-less vented 19-in. shelf. Mounts onto rack angles that have EIA-spaced square holes (.375 in.). Shelf slides open and provides a variable-sized, continuous surface for equipment. Back of shelf has oval cutouts for power and data cables. Accessory hole patterns at back of shelf fit small and large D-rings to help manage cable. Made of steel with a 150 lb. (68 kg) static load rating. Available with RAL 9005 black or RAL 7035 gray polyester powder coat finish.

**Note: For square-hole rack angles only!**

**BULLETIN: DACCY**

Catalog Number	Description	Finish	Minimum Depth mm/in.	Maximum Depth mm/in.	Rack Angle Type
D19FVT69B	Shelf, vented, 19 in. tool-less	Black	495 19.50	851 33.50	Square hole only
D19FVT69G	Shelf, vented, 19 in. tool-less	Gray	495 19.50	851 33.50	Square hole only
D19FVT912B	Shelf, vented, 19 in. tool-less	Black	792 31.20	1151 45.30	Square hole only
D19FVT912G	Shelf, vented, 19 in. tool-less	Gray	792 31.20	1151 45.30	Square hole only

Minimum and maximum depth measured from rack angle to rack angle.

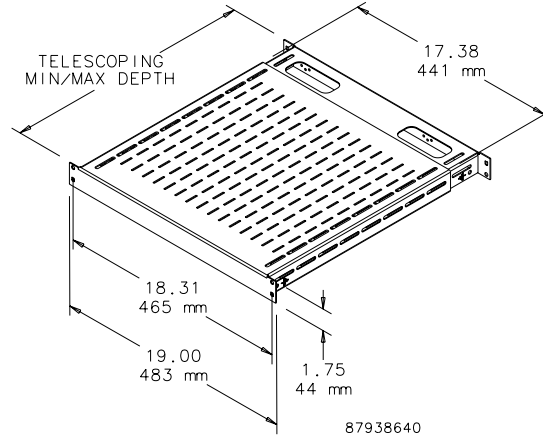

### NET SERIES JOINING KIT

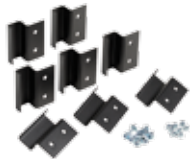

The joining kit enables joining Net Series Cabinets without sides to form a single bank of cabinets. Each kit joins two cabinets.

**BULLETIN: DCY**

Catalog Number	Description
NJK	Net Series Joining Kit