

## Square Body DIN 43 653 — 690V/700V (IEC/UL): 10-400A

### 690V/700V (IEC/UL) 10-400A

#### Specifications

**Description:** Square body DIN 43-653 stud mount high speed fuses.

**Dimensions:** See dimensions illustration.

#### Ratings:

Volts: — 690Vac (IEC)  
— 700Vac (UL)

Amps: — 10-400A

IR: — 200kA RMS Sym.

**Agency Information:** CE, Designed and tested to IEC 60269: Part 4, UL Recognized. UL Recognition/CSA Component Acceptance on Size 000.

#### Electrical Characteristics

##### Total Clearing $I^2t$

The total clearing  $I^2t$  at rated voltage and at power factor of 15% are given in the electrical characteristics. For other voltages, the clearing  $I^2t$  is found by multiplying by correction factor, K, given as a function of applied working voltage,  $E_g$ , (rms).

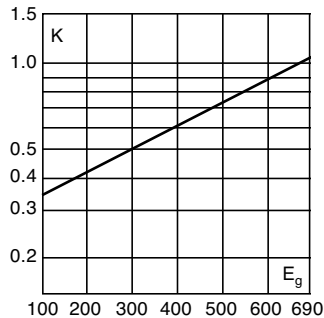

#### Dimensions (mm)

Type -U/80, -/80, -TN/80

Size	D	E	F	G	H	K
000	40	21	20	51	8	2
00	51	30	28	67	10	2

1mm = 0.0394" / 1" = 25.4mm

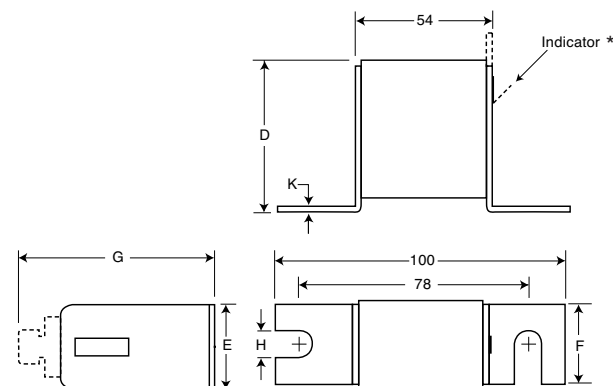

\* Indication for Size 00 fuses is a red pin.



#### Arc Voltage

This curve gives the peak arc voltage,  $U_L$ , which may appear across the fuse during its operation as a function of the applied working voltage,  $E_g$ , (rms) at a power factor of 15%.

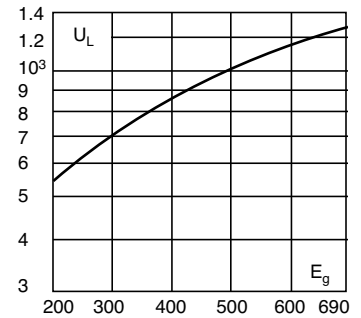

#### Power Losses

Watts loss at rated current is given in the electrical characteristics. The curve allows the calculation of the power losses at load currents lower than the rated current. The correction factor,  $K_p$ , is given as a function of the RMS load current,  $I_b$ , in % of the rated current.

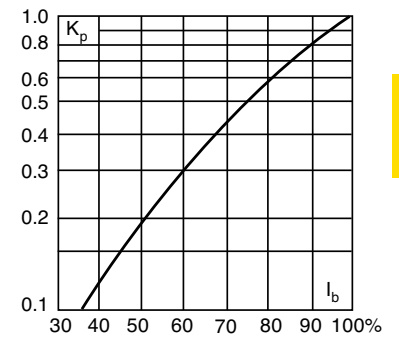

#### Features and Benefits

- Excellent DC performance
- Low arc voltage and low energy let-through ( $I^2t$ )
- Low watts loss
- Superior cycling capability

#### Typical Applications

- DC common bus
- DC drives
- Power converters/rectifiers
- Reduced voltage starters

#### For Other Voltage Ratings in This Body Style

- See page 144 (1000V)

#### Dimensions (mm)

Type 00B/60, 00BTN/60

1mm = 0.0394" / 1" = 25.4mm

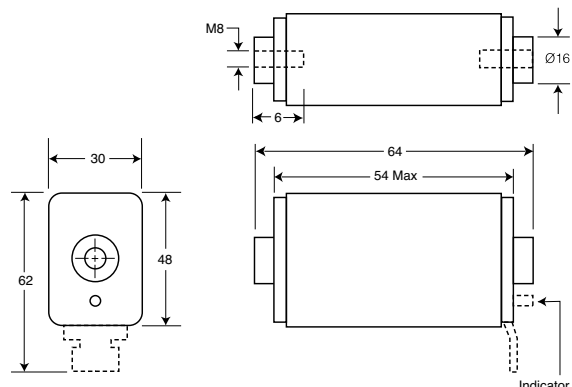

## Square Body DIN 43 653 — 690V/700V (IEC/UL): 10-400A

### Catalog Numbers

Catalog Numbers					Size	Electrical Characteristics			
-U/80 Without Indicator	-80 Visual Indicator	-TN/80 Type T Indicator for Micro	00B/60 Visual Indicator	00BTN/60 Type T Indicator for Micro		Rated Current RMS-Amps	Pt (A² Sec)		Watts Loss
							Pre-arc	Clearing at 660V	
170M1308	170M1358	170M1408			10	3.8	25.5	3.0	
170M1309	170M1359	170M1409			16	7.2	48	5.5	
170M1310	170M1360	170M1410			20	11.5	78	7	
170M1311	170M1361	170M1411			25	19	130	9	
170M1312	170M1362	170M1412			32	40	270	10	
170M1313	170M1363	170M1413			40	69	460	12	
170M1314	170M1364	170M1414			50	115	770	15	
170M1315	170M1365	170M1415			63	215	1450	16	
170M1316	170M1366	170M1416			80	380	2550	19	
170M1317	170M1367	170M1417			100	695	4650	24	
170M1318	170M1368	170M1418			125	1200	8500	28	
170M1319	170M1369	170M1419			160	2300	16000	32	
170M1320	170M1370	170M1420			200	4200	28000	37	
170M1321	170M1371	170M1421			250	7750	51500	42	
170M1322	170M1372	170M1422			315	12000	80500	52	
	170M2608	170M2658	170M2708	170M2758		25	19	130	6
	170M2609	170M2659	170M2709	170M2759		32	28.5	195	7
	170M2610	170M2660	170M2710	170M2760		40	50	360	9
	170M2611	170M2661	170M2711	170M2761		50	95	640	10
	170M2612	170M2662	170M2712	170M2762		63	170	1200	12
	170M2613	170M2663	170M2713	170M2763		80	310	2100	15
	170M2614	170M2664	170M2714	170M2764	00	100	620	4150	20
	170M2615	170M2665	170M2715	170M2765		125	1000	6950	25
	170M2616	170M2666	170M2716	170M2766		160	1900	13000	30
	170M2617	170M2667	170M2717	170M2767		200	3400	23000	35
	170M2618	170M2668	170M2718	170M2768		250	6250	42000	45
	170M2619	170M2669	170M2719	170M2769		315	10000	68500	55
	170M2620	170M2670	170M2720	170M2770		350	13500	91500	60
	170M2621	170M2671	170M2721	170M2771		400	18000	125000	70

- Watts loss provided at rated current.
- Microswitch indicator ordered separately.
- See accessories on pages 185-186.
- For fuse curves see page 119.

## Square Body Size 000, 00 — 690V/700V (IEC/UL): 10-400A

### Size 000 — 10-315A: 690V

Time-Current Curve

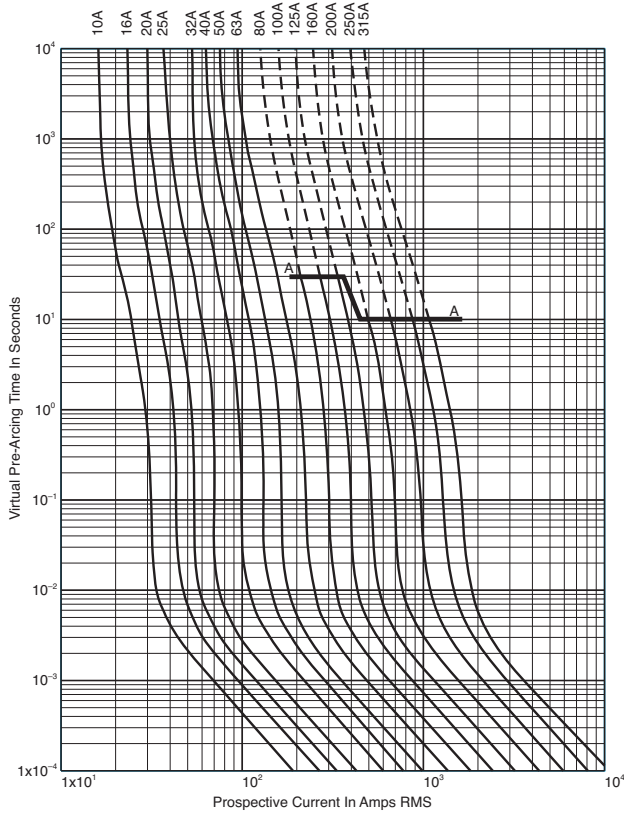

### Size 00 — 25-400A: 690V

Time-Current Curve

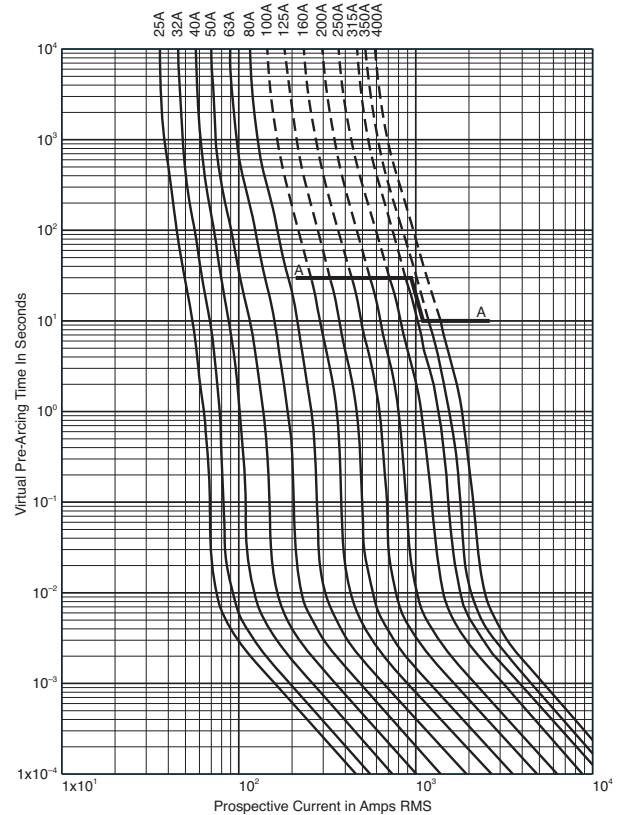

High Speed Fuses

### Peak Let-Through Curve

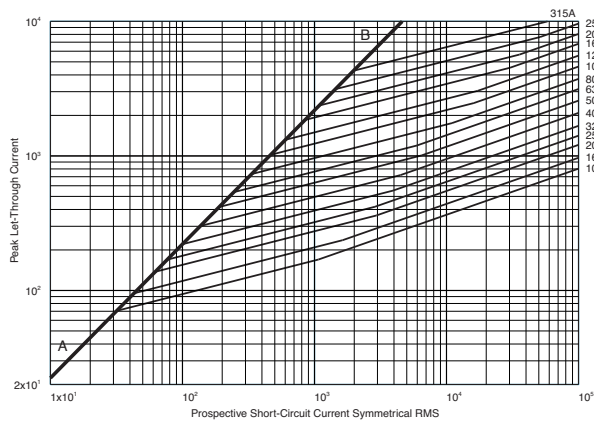

### Peak Let-Through Curve

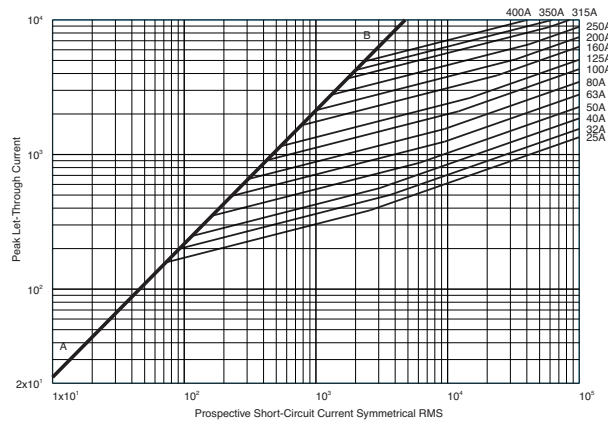

Data Sheet: 17056310

Data Sheet: 172056312