

AEB Series Bolted Motor Starters and Contactors

Explosionproof, Dust-Ignitionproof, Watertight

Full Voltage. Combination and Non-Combination.

NEC/CEC:

Class I, Division 1 and 2, Groups B, C, D
Class I, Zone 1 and 2, Groups IIB + H₂
Class II, Division 1 and 2, Groups E, F, G
Class III

NEC/CEC:

NEMA 4, 4X, 7BCD, 9EFG
CSA Type 4, 4X

Application

- Combination and non-combination motor starters are used in areas where hazardous materials are handled or stored.
- These units provide disconnecting means, undervoltage protection, circuit protection, and motor running protection.

Features

- Copperfree cast aluminum.
- Precision machined flame path between box and cover.
- Bolt on slotted mounting feet.
- Stainless steel, captive Quad-Lead® cover bolts (disengage in 1-1/2 turns).
- External stainless steel breaker operating handle.
- Ground lug package and installation instructions for termination of ground wire enclosed.
- Four point control terminal block, NEMA 1B with wire markers.
- Breaker operators can be locked in the ON or OFF position (combination starters only).
- Four plugged 3/4" NPSM outlets drilled and tapped for control devices.
- Standard outlets top and bottom.
- Plugged 1/2" outlets top and bottom for optional breather/drain.
- Components are mounted on a galvanized steel removable pan.
- Enclosures are designed to accept Cutler-Hammer +, or Square D ■ motor starters/circuit breakers. For other manufacturers, contact your local representative.
- O-ring gasket insures watertight integrity.

Standard Materials

- Bodies and covers: copperfree (4/10 of 1%) aluminum
- Block hinges, cover bolts, handle, breaker and operator shafts: stainless steel
- O-ring: neoprene

Standard Finish

- Corrosion resistant gray powder coat epoxy inside and out

Options

- See modifications page.

NEC Certifications and Compliances

- ANSI/UL Standards: UL 508, UL 50, UL 1203
- CSA Standards: C22.2 No. 0-10, C22.2 No. 14-10, C22.2 No. 25-1996, C22.2 No. 30-M1986 and C22.2 No. 94-M91
- cCSAus Certified: 2561837

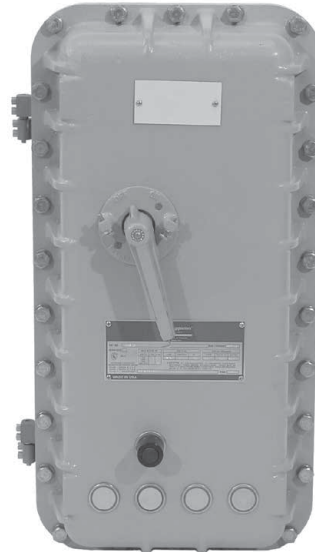

CONTROLS: NEC/CEC EXPLOSIONPROOF MOTOR STARTERS

Appleton®

+ Cutler-Hammer is a registered trademark of Eaton Corporation.

■ Square D is a registered trademark of Schneider Electric.

AEB Series Bolted Motor Starters and Contactors

Explosionproof, Dust-Ignitionproof, Watertight

Full Voltage. Combination and Non-Combination.

NEC/CEC:

Class I, Division 1 and 2, Groups B, C, D
 Class I, Zone 1 and 2, Groups IIB + H₂
 Class II, Division 1 and 2, Groups E, F, G
 Class III

NEC/CEC:

NEMA 4, 4X, 7BCD, 9EFG
 CSA Type 4, 4X

Catalog Numbering Guide

Example: The part number below depicts an Appleton, Class I, Division I, Groups B, C and D, NEMA Size 1, Bolted type, Combination Full Voltage Nonreversing Motor Starter operating at 480 Vac, Cutler-Hammer + starter w/120 Vac control voltage, and a Cutler-Hammer 7A MCP. If a breaker is not required, omit last two characters.

CONTROLS: NEC/CEC EXPLOSIONPROOF MOTOR STARTERS

<p>AE</p> <p>NEC/CEC Certified AE Series</p>	<p>1</p> <p>NEMA Size: 0 1 2 3 4 5</p>	<p>B</p> <p>Starter Function: A - FVNR (ATL) B - Combination FVNR M - Lighting Contactor (3- thru 12-pole) ① N - Combination Lighting Contactor (3- thru 12-pole) ①</p> <p>Optional Starter Function ②: C - FVR D - Combination FVR E - 2S1W F - Comb. 2S1W G - 2S2W H - Combination 2S2W J - Contactor (3 pole) K - Combination Contactor (3-pole)</p>	<p>4</p> <p>Operating Voltage: 1 - 120 Vac 2 - 240 Vac 3 - 380 Vac 4 - 480 Vac 6 - 600 Vac 9 - 208 Vac</p>	<p>W</p> <p>Starter Manufacturer: ③ W - Standard; Eaton/Cutler-Hammer (A200) C - Freedom (AN16) Bi Metal; Eaton/Cutler-Hammer and A - Freedom (AN19) Electronic; Eaton/Cutler-Hammer S - Square D</p>	<p>1</p> <p>Control Voltage (120 V coil standard): 1 - 120 Vac 2 - 240 Vac 3 - 380 Vac 4 - 480 Vac 6 - 600 Vac 8 - 480 V Coil/120 V Control 9 - 208 Vac 0 - 277 Vac</p>	<p>C</p> <p>Breaker Manufacturer: ③ C - Cutler-Hammer S - Square D</p>	<p>2</p> <p>MCP or Breaker Trip: MCP 1 - 3 Amp 2 - 7 Amp 3 - 15 Amp 4 - 30 Amp 5 - 50 Amp 6 - 70 Amp 7 - 100 Amp 8 - 150 Amp 9 - 250 Amp 0 - 400 Amp</p>	<p>▲</p> <p>Suffix for Other Options/Features: See Modifications</p> <p>Breaker Trip (Thermal Mag): A - 15 Amp B - 20 Amp C - 25 Amp D - 30 Amp E - 35 Amp F - 40 Amp G - 50 Amp H - 60 Amp J - 70 Amp K - 80 Amp M - 90 Amp N - 100 Amp P - 125 Amp Q - 150 Amp R - 175 Amp S - 200 Amp T - 225 Amp U - 250 Amp V - 300 Amp W - 350 Amp X - 400 Amp</p>
---	---	--	---	--	--	---	---	---

① Standard starter is manufactured by Square D; electrically operated, electrically held. Optional starter manufacture is ASCO; electrically operated, mechanically held. Contact your local sales representative for details.

② Contact your local sales representative for details.

③ Contact your local sales representative for additional UL Classified starters (Allen Bradley 509 and Vacuum, Sprecher and Schuh, Siemens, GE, and Cutler Hammer ITT Softstart and V200 Vacuum).

AEB Series Bolted Motor Starters and Contactors

Explosionproof, Dust-Ignitionproof, Watertight

Full Voltage. Combination and Non-Combination.

NEC/CEC:

Class I, Division 1 and 2, Groups B, C, D
Class I, Zone 1 and 2, Groups IIB + H₂
Class II, Division 1 and 2, Groups E, F, G
Class III

NEC/CEC:

NEMA 4, 4X, 7BCD, 9EFG
CSA Type 4, 4X

Empty Enclosure

NEMA Size	Catalog Number [▲]	Approximate Weight kg (lb)	Standard Conduit (Inches)	Mounting Hardware Set Catalog Number
Full Voltage Nonreversing Enclosure Only				
0	AE0BA	36 (80)		
1	AE1BA	36 (80)	1-1/2	
2	AE2BA	39 (85)		AMH7
3	AE3BA	64 (140)	2	
4	AE4BA	64 (140)	2-1/2	
5	AE5BA	227 (500)	4	AMH8

Dimensions in Millimeters (Inches) – Starter Only

Enclosure Layout for Size 0, 1 and 2 – Starter Only

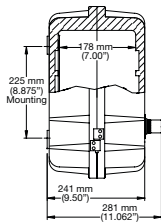

Left Side View

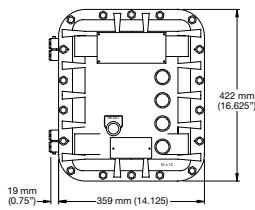

Front View

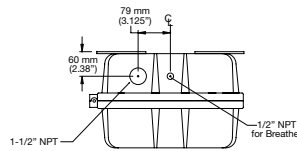

Top View

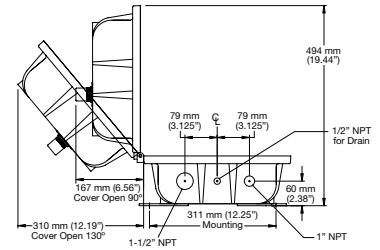

Bottom View

Enclosure Layout for Size 3 – Starter Only

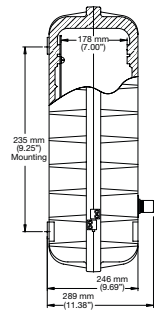

Left Side View

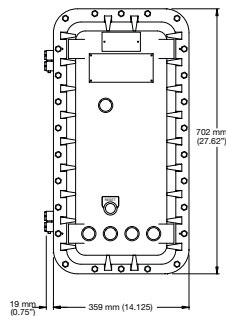

Front View

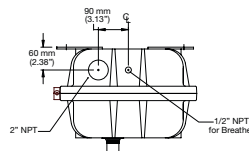

Top View

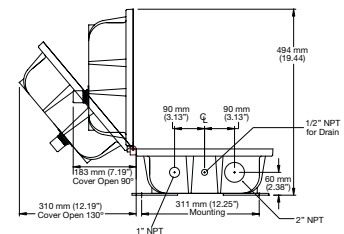

Bottom View

▲ To complete the catalog number please add the appropriate suffix for other options/features. Suffixes, see AEB Series Motor Starters Modifications.

CONTROLS: NEC/CEC EXPLOSIONPROOF MOTOR STARTERS



AEB Series Bolted Motor Starters and Contactors

Explosionproof, Dust-Ignitionproof, Watertight

Full Voltage. Combination and Non-Combination.

NEC/CEC:

Class I, Division 1 and 2, Groups B, C, D
 Class I, Zone 1 and 2, Groups IIB + H₂
 Class II, Division 1 and 2, Groups E, F, G
 Class III

NEC/CEC:

NEMA 4, 4X, 7BCD, 9EFG
 CSA Type 4, 4X

Dimensions in Millimeters (Inches) – Starter Only

Enclosure Layout for Size 4 – Starter Only

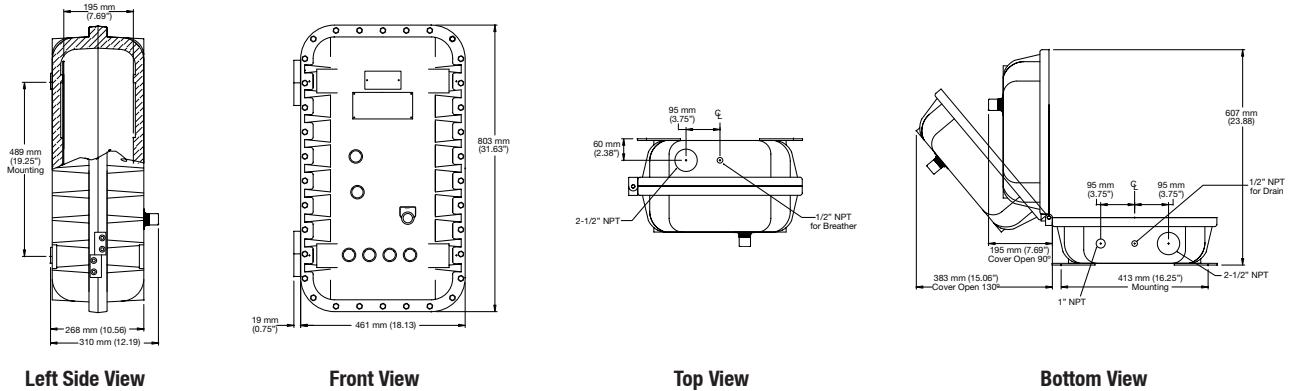

Enclosure Layout for Size 5 – Starter Only

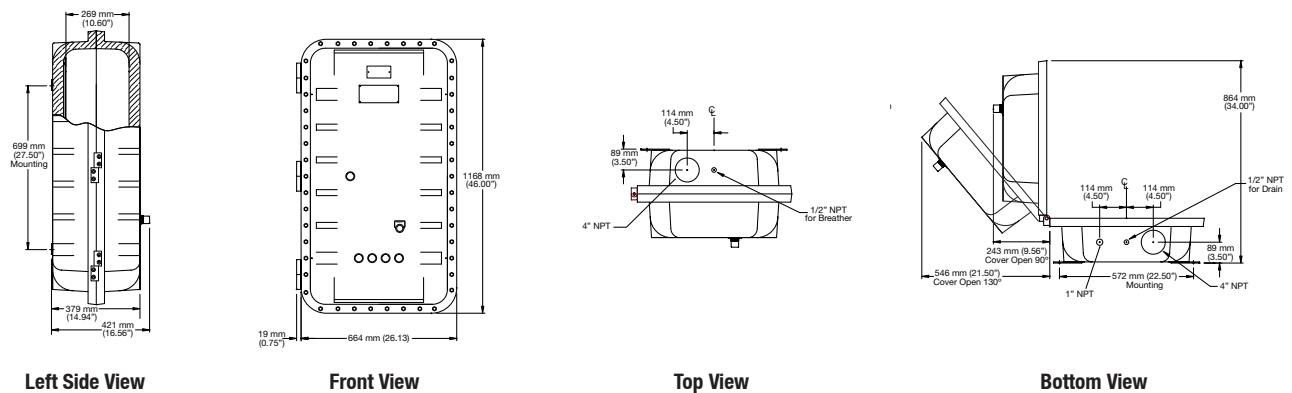

CONTROLS: NEC/CEC EXPLOSIONPROOF MOTOR STARTERS



AEB Series Bolted Motor Starters and Contactors

Explosionproof, Dust-Ignitionproof, Watertight

Full Voltage. Combination and Non-Combination.

NEC/CEC:

Class I, Division 1 and 2, Groups B, C, D
Class I, Zone 1 and 2, Groups IIB + H₂
Class II, Division 1 and 2, Groups E, F, G
Class III

NEC/CEC:

NEMA 4, 4X, 7BCD, 9EFG
CSA Type 4, 4X

Empty Enclosure

NEMA Size	Catalog Number [▲]	Approximate Weight kg (lb)	Standard Conduit (Inches)	Mounting Hardware Set Catalog Number
Combination Full Voltage Nonreversing Enclosure Only				
0	AE0BB	36 (80)	1-1/2	AMH7
1	AE1BB	36 (80)		
2	AE2BB	39 (85)		
3	AE3BB	64 (140)	2-1/2	AMH8
4	AE4BB	64 (140)		
5	AE5BB	227 (500)	4	AMH8

Dimensions in Millimeters (Inches) – Combination

Enclosure Layout for Size 0, 1 and 2 – Combination

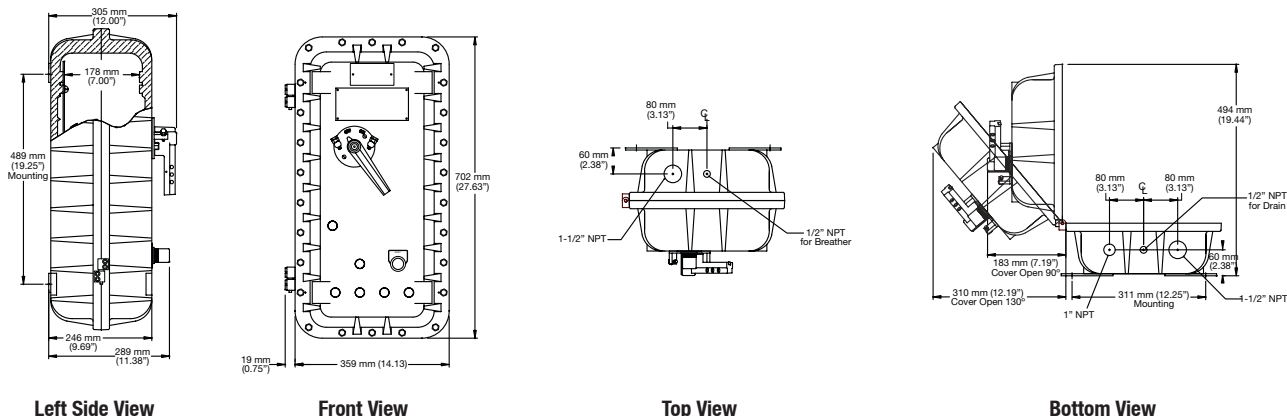

Enclosure Layout for Size 3 and 4 – Combination

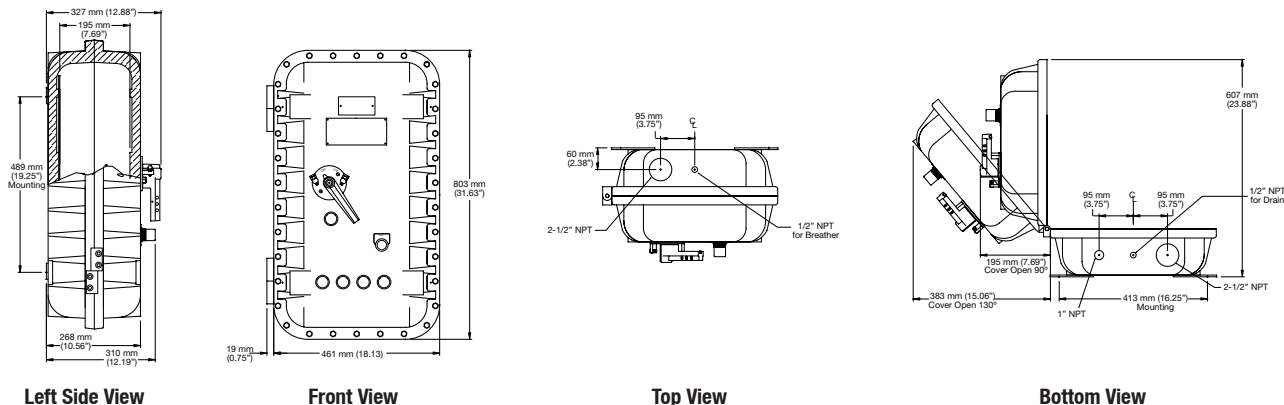

▲ To complete the catalog number please add the appropriate suffix for other options/features. Suffixes, see AEB Series Motor Starters Modifications.

AEB Series Bolted Motor Starters and Contactors

Explosionproof, Dust-Ignitionproof, Watertight

Full Voltage. Combination and Non-Combination.

NEC/CEC:

Class I, Division 1 and 2, Groups B, C, D
 Class I, Zone 1 and 2, Groups IIB + H₂
 Class II, Division 1 and 2, Groups E, F, G
 Class III

NEC/CEC:

NEMA 4, 4X, 7BCD, 9EFG
 CSA Type 4, 4X

Dimensions in Millimeters (Inches) – Combination

Enclosure Layout for Size 5 – Combination

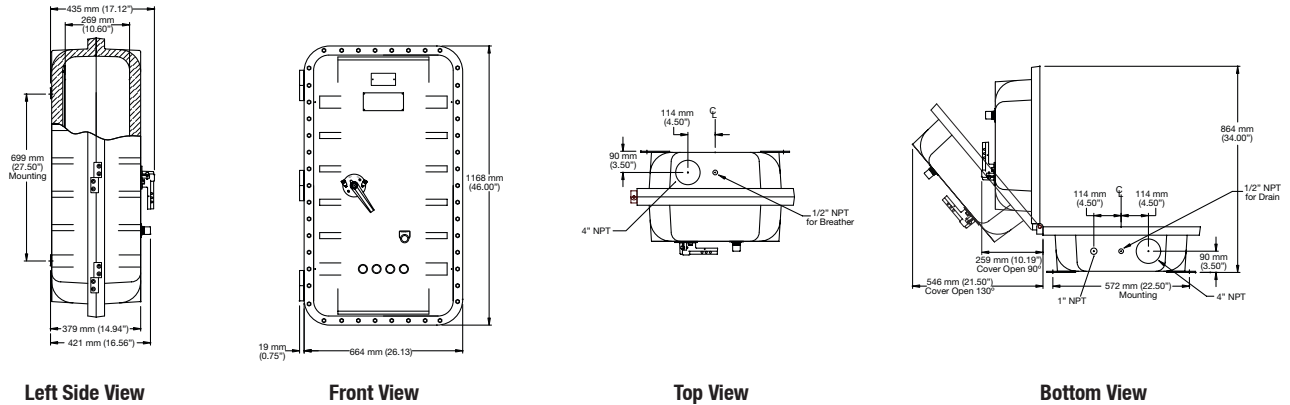

CONTROLS: NEC/CEC EXPLOSIONPROOF MOTOR STARTERS



AEB Series Bolted Motor Starters and Contactors

Explosionproof, Dust-Ignitionproof, Watertight

Full Voltage. Combination and Non-Combination.

NEC/CEC:

Class I, Division 1 and 2, Groups B, C, D
Class I, Zone 1 and 2, Groups IIB + H₂
Class II, Division 1 and 2, Groups E, F, G
Class III

NEC/CEC:

NEMA 4, 4X, 7BCD, 9EFG
CSA Type 4, 4X

Full Voltage Motor Starter – Nonreversing – 3-Phase, 60 Hertz, 120 V Coil

Line Voltage	NEMA Size	Maximum Horsepower	Amp Trip	Catalog Number [▲]	Approximate Weight kg (lb)	Conduit Size (Inches)	Mounting Hardware Set Catalog Number
480	0	5	NA	AE0BA4W1	36 (80)	1-1/2	AMH7
	1	10	NA	AE1BA4W1	36 (80)		
	2	25	NA	AE2BA4W1	39 (85)	2	
	3	50	NA	AE3BA4W1	64 (140)		
	4	100	NA	AE4BA4W1	64 (140)	2-1/2	
600	5	200	NA	AE5BA4W1	227 (500)	4	AMH8
	0	5	NA	AE0BA6W1	57 (125)	1-1/2	AMH7
	1	10	NA	AE1BA6W1	57 (125)		
	2	25	NA	AE2BA6W1	59 (130)	2	
	3	50	NA	AE3BA6W1	88 (195)		
	4	100	NA	AE4BA6W1	88 (195)	2-1/2	
5	200	NA	AE5BA6W1	227 (500)	4	AMH8	

Wiring Diagrams

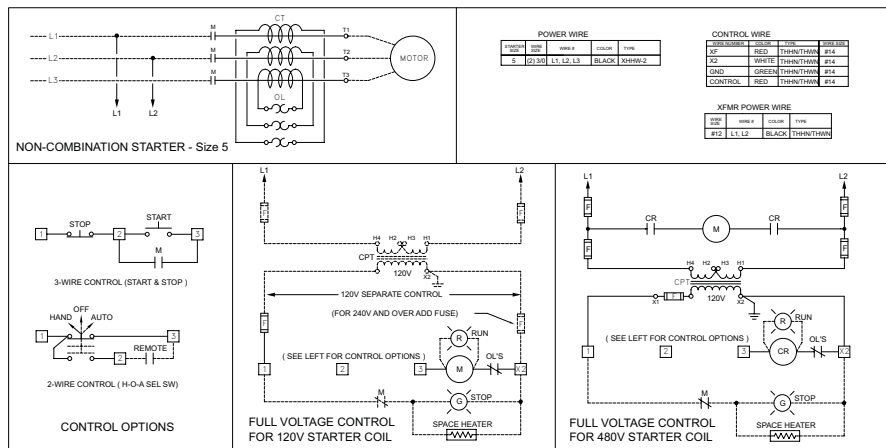
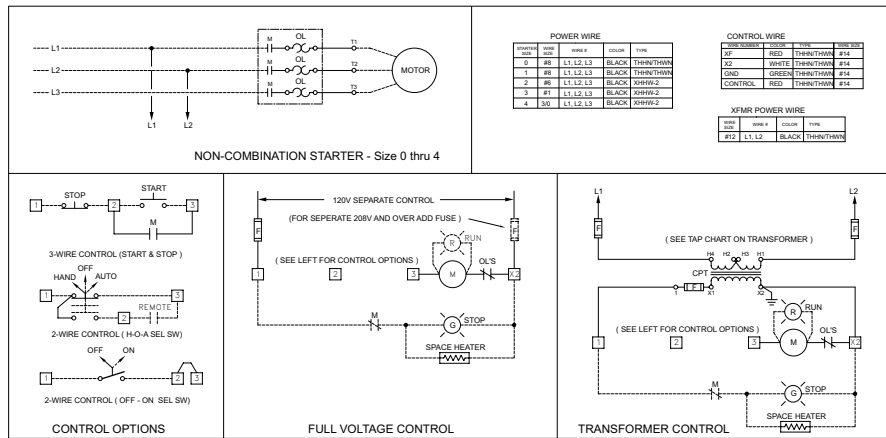

▲ To complete the catalog number please add the appropriate suffix for other options/features. Suffixes, see AEB Series Motor Starters Modifications.

AEB Series Bolted Motor Starters and Contactors

Explosionproof, Dust-Ignitionproof, Watertight

Full Voltage. Combination and Non-Combination.

NEC/CEC:

Class I, Division 1 and 2, Groups B, C, D
 Class I, Zone 1 and 2, Groups IIB + H₂
 Class II, Division 1 and 2, Groups E, F, G
 Class III

NEC/CEC:

NEMA 4, 4X, 7BCD, 9EFG
 CSA Type 4, 4X

Dimensions in Millimeters (Inches) – Starter Only

Enclosure Layout for Size 0, 1 and 2 – Starter Only

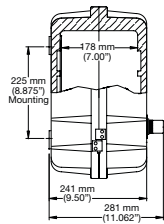

Left Side View

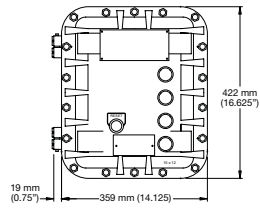

Front View

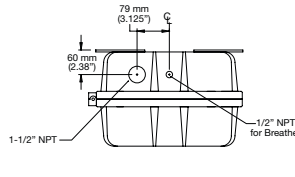

Top View

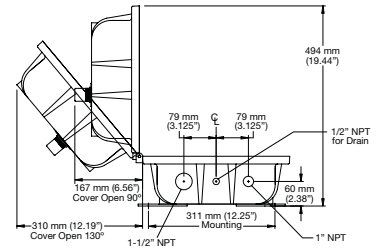

Bottom View

Enclosure Layout for Size 3 – Starter Only

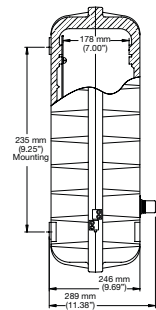

Left Side View

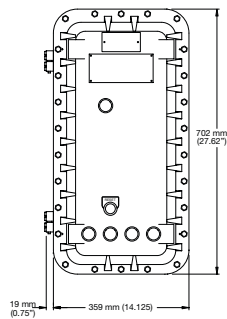

Front View

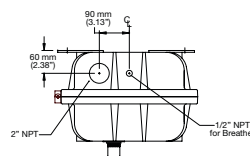

Top View

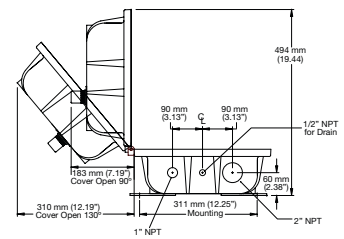

Bottom View

CONTROLS: NEC/CEC EXPLOSIONPROOF MOTOR STARTERS



AEB Series Bolted Motor Starters and Contactors

Explosionproof, Dust-Ignitionproof, Watertight

Full Voltage. Combination and Non-Combination.

NEC/CEC:

Class I, Division 1 and 2, Groups B, C, D
 Class I, Zone 1 and 2, Groups IIB + H₂
 Class II, Division 1 and 2, Groups E, F, G
 Class III

NEC/CEC:

NEMA 4, 4X, 7BCD, 9EFG
 CSA Type 4, 4X

Dimensions in Millimeters (Inches) – Starter Only

Enclosure Layout for Size 4 – Starter Only

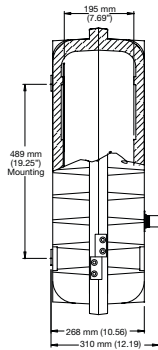

Left Side View

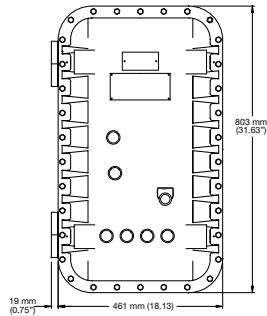

Front View

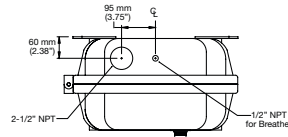

Top View

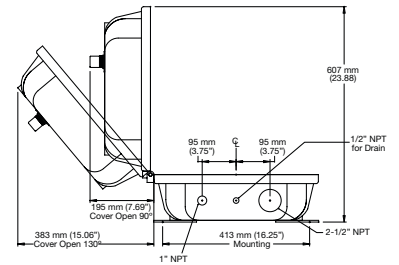

Bottom View

Enclosure Layout for Size 5 – Starter Only

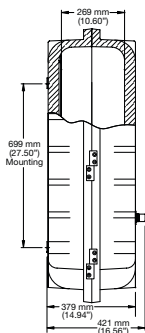

Left Side View

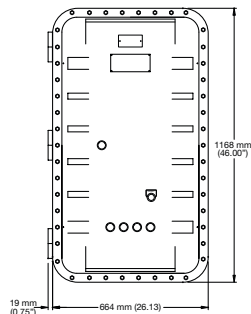

Front View

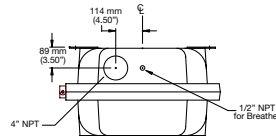

Top View

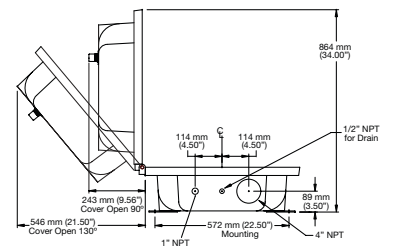

Bottom View

CONTROLS: NEC/CEC EXPLOSIONPROOF MOTOR STARTERS



AEB Series Bolted Motor Starters and Contactors

Explosionproof, Dust-Ignitionproof, Watertight

Full Voltage, Combination and Non-Combination.

NEC/CEC:

Class I, Division 1 and 2, Groups B, C, D
 Class I, Zone 1 and 2, Groups IIB + H₂
 Class II, Division 1 and 2, Groups E, F, G
 Class III

NEC/CEC:

NEMA 4, 4X, 7BCD, 9EFG
 CSA Type 4, 4X

Combination Full Voltage Motor Starters With Motor Circuit Protector (MCP) — Nonreversing — 3-Phase, 60 Hertz, 120 V Coil

Line Voltage	NEMA Size	Maximum Horsepower	Amp Trip	Catalog Number [▲]	Approximate Weight kg (lb)	Conduit Size (Inches)	Mounting Hardware Set Catalog Number	
480	0	1	3	AE0BB4W1C1	57 (125)	1-1/2	AMH7	
		3	7	AE0BB4W1C2	57 (125)			
		5	15	AE0BB4W1C3	57 (125)			
	1	7	15	AE1BB4W1C3	57 (125)			
		10	30	AE1BB4W1C4	59 (130)			
	2	12	30	AE2BB4W1C4	59 (130)			
		25	50	AE2BB4W1C5	59 (130)			
	3	30	50	AE3BB4W1C5	88 (195)			2-1/2
		50	100	AE3BB4W1C7	88 (195)			
	4	100	150	AE4BB4W1C8	88 (195)			
5	200	400	AE5BB4W1C0	227 (500)	4	AMH8		
600	0	1	3	AE0BB6W1C1	57 (125)	1-1/2	AMH7	
		3	7	AE0BB6W1C2	57 (125)			
		5	15	AE0BB6W1C3	57 (125)			
	1	7	15	AE1BB6W1C3	57 (125)			
		10	30	AE1BB6W1C4	57 (125)			
	2	20	30	AE2BB6W1C4	59 (130)			2-1/2
		25	50	AE2BB6W1C5	59 (130)			
	3	40	50	AE3BB6W1C5	88 (195)			2-1/2
		50	100	AE3BB6W1C7	88 (195)			
	4	60	100	AE4BB6W1C7	88 (195)			2-1/2
100		150	AE4BB6W1C8	88 (195)				
5	200	400	AE5BB6W1C0	227 (500)	4	AMH8		

CONTROLS: NEC/CEC EXPLOSIONPROOF MOTOR STARTERS



▲ To complete the catalog number please add the appropriate suffix for other options/features. Suffixes, see AEB Series Motor Starters Modifications.

AEB Series Bolted Motor Starters and Contactors

Explosionproof, Dust-Ignitionproof, Watertight

Full Voltage. Combination and Non-Combination.

NEC/CEC:

Class I, Division 1 and 2, Groups B, C, D
Class I, Zone 1 and 2, Groups IIB + H₂
Class II, Division 1 and 2, Groups E, F, G
Class III

NEC/CEC:

NEMA 4, 4X, 7BCD, 9EFG
CSA Type 4, 4X

Combination Full Voltage Motor Starters With Motor Circuit Protector (MCP) — Nonreversing— 3-Phase, 60 Hertz, 120 V Coil

Wiring Diagram

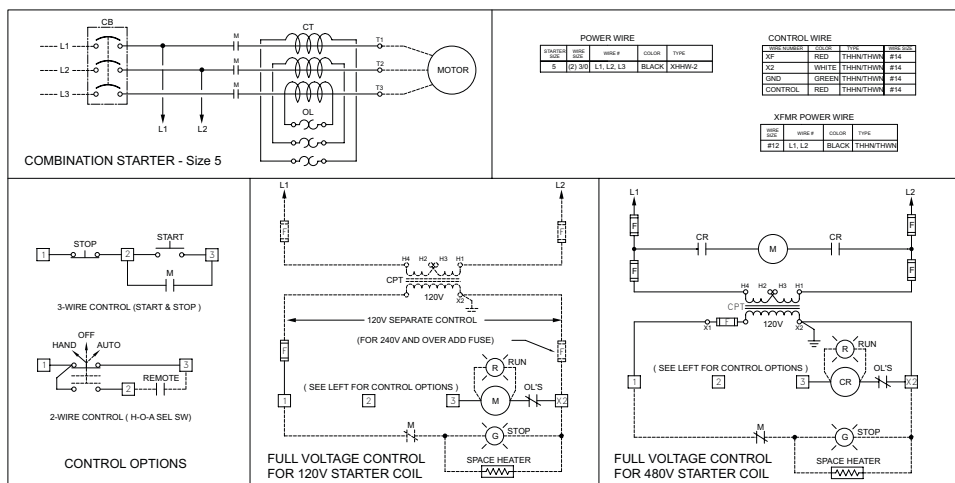
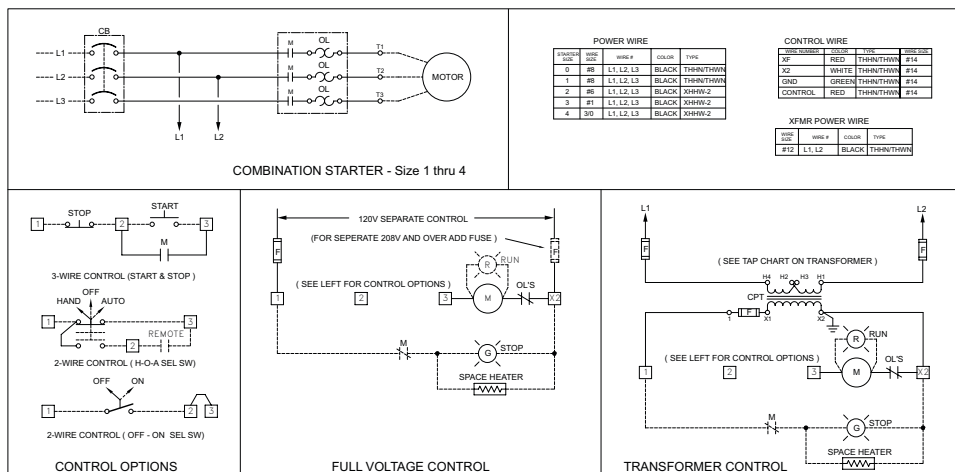

CONTROLS: NEC/CEC EXPLOSIONPROOF MOTOR STARTERS



AEB Series Bolted Motor Starters and Contactors

Explosionproof, Dust-Ignitionproof, Watertight

Full Voltage. Combination and Non-Combination.

NEC/CEC:

Class I, Division 1 and 2, Groups B, C, D
 Class I, Zone 1 and 2, Groups IIB + H2
 Class II, Division 1 and 2, Groups E, F, G
 Class III

NEC/CEC:

NEMA 4, 4X, 7BCD, 9EFG
 CSA Type 4, 4X

Dimensions in Millimeters (Inches) – Combination

Enclosure Layout for Size 0, 1 and 2 – Combination

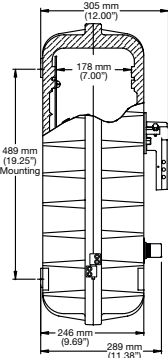

Left Side View

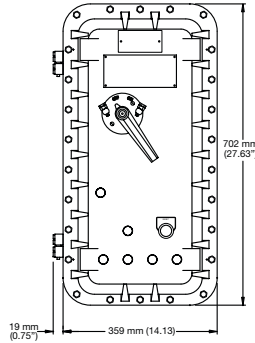

Front View

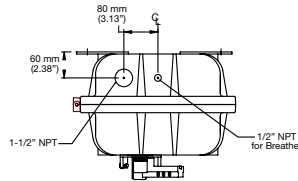

Top View

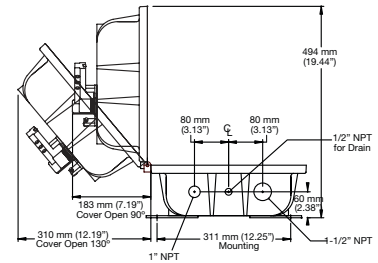

Bottom View

Enclosure Layout for Size 3 and 4 – Combination

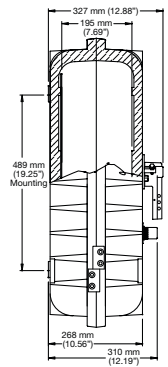

Left Side View

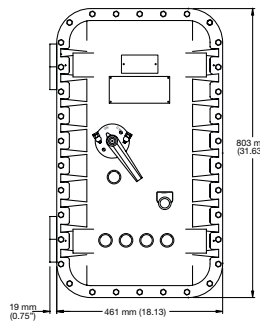

Front View

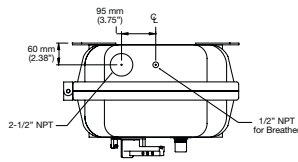

Top View

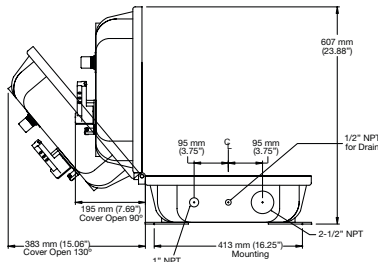

Bottom View

Enclosure Layout for Size 5 – Combination

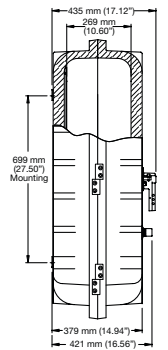

Left Side View

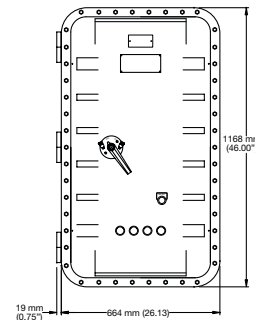

Front View

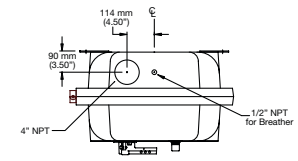

Top View

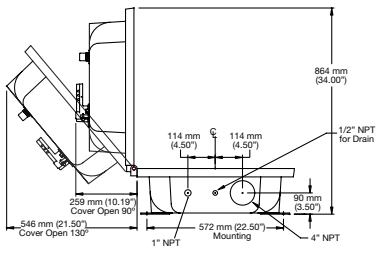

Bottom View

CONTROLS: NEC/CEC EXPLOSIONPROOF MOTOR STARTERS

Appleton

AEB Series Bolted Motor Starters and Contactors

Explosionproof, Dust-Ignitionproof, Watertight

Full Voltage. Combination and Non-Combination.

NEC/CEC:

Class I, Division 1 and 2, Groups B, C, D
Class I, Zone 1 and 2, Groups IIB + H₂
Class II, Division 1 and 2, Groups E, F, G
Class III

NEC/CEC:

NEMA 4, 4X, 7BCD, 9EFG
CSA Type 4, 4X

Combination Full Voltage Motor Starters with Thermal Magnetic Circuit Breaker – Nonreversing — 3-Phase, 60 Hertz, 120 V Coil

Line Voltage	NEMA Size	Maximum Horsepower	Amp Trip	Catalog Number [▲]	Approximate Weight (kg (lb))	Conduit Size (Inches)	Mounting Hardware Set Catalog Number	
480	0	3	15	AE0BB4W1CA	57 (125)	1-1/2	AMH7	
		5	20	AE0BB4W1CB	57 (125)			
	1	7-1/2	30	AE1BB4W1CD	57 (125)			
		10	35	AE1BB4W1CE	57 (125)			
	2	20	50	AE2BB4W1CG	59 (130)			2-1/2
		25	70	AE2BB4W1CJ	59 (130)			
	3	50	100	AE3BB4W1CN	88 (195)			
		60	125	AE3BB4W1CP	88 (195)			
	4	75	150	AE4BB4W1CQ	88 (195)	4		
		100	200	AE4BB4W1CS	88 (195)			
		125	250	AE5BB4W1CU	227 (500)			
	5	150	300	AE5BB4W1CV	227 (500)		AMH8	
200		400	AE5BB4W1CX	227 (500)				
600	0	5	15	AE0BB6W1CA	57 (125)		1-1/2	AMH7
		1	7-1/2	20	AE1BB6W1CB	57 (125)		
	10		30	AE1BB6W1CD	57 (125)			
	2	15	40	AE2BB6W1CF	59 (130)	2-1/2		
		25	50	AE2BB6W1CG	59 (130)			
	3	30	70	AE3BB6W1CJ	88 (195)			
		50	100	AE3BB6W1CN	88 (195)			
	4	75	125	AE4BB6W1CP	88 (195)	4		
		100	150	AE4BB6W1CQ	88 (195)			
	5	150	250	AE5BB6W1CU	227 (500)		AMH8	
		200	300	AE5BB6W1CV	227 (500)			

CONTROLS: NEC/CEC EXPLOSIONPROOF MOTOR STARTERS



▲ To complete the catalog number please add the appropriate suffix for other options/features. Suffixes, see AEB Series Motor Starters Modifications.

AEB Series Bolted Motor Starters and Contactors

Explosionproof, Dust-Ignitionproof, Watertight

Full Voltage. Combination and Non-Combination.

NEC/CEC:

Class I, Division 1 and 2, Groups B, C, D
 Class I, Zone 1 and 2, Groups IIB + H2
 Class II, Division 1 and 2, Groups E, F, G
 Class III

NEC/CEC:

NEMA 4, 4X, 7BCD, 9EFG
 CSA Type 4, 4X

Combination Full Voltage Motor Starters with Thermal Magnetic Circuit Breaker – Nonreversing – 3-Phase, 60 Hertz, 120 V Coil

Wiring Diagram

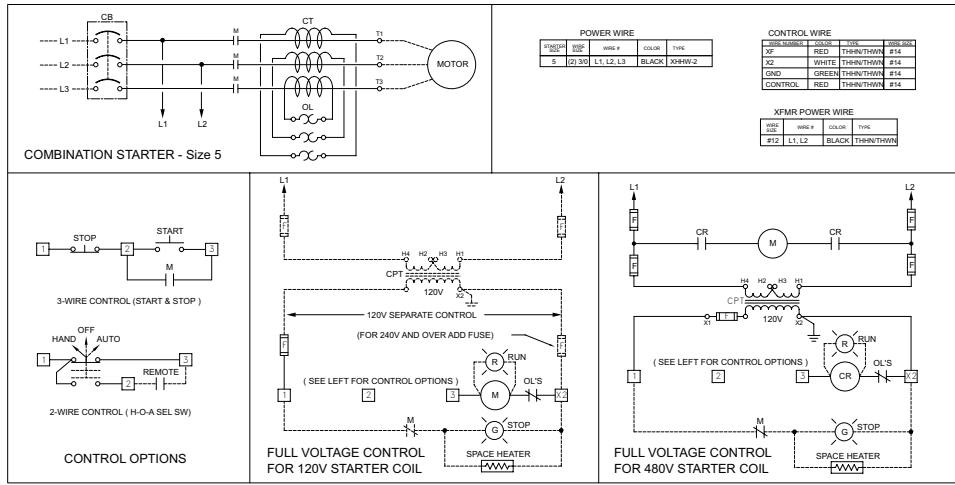
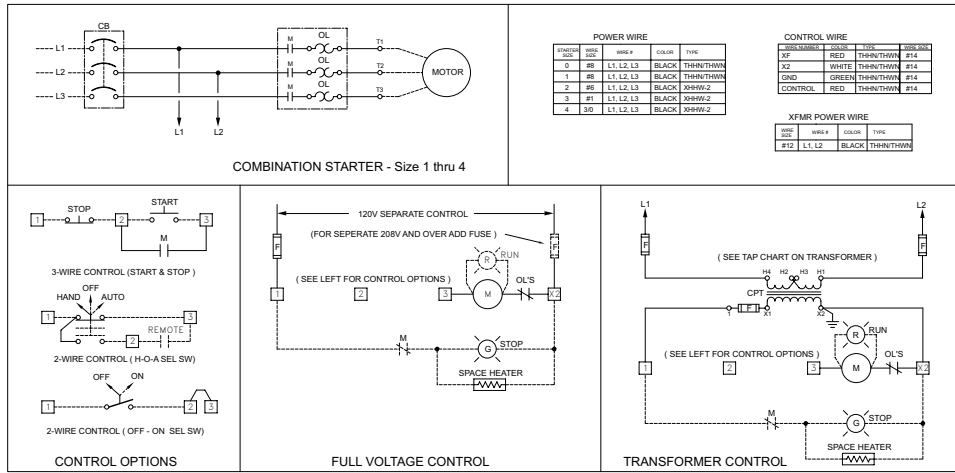

CONTROLS: NEC/CEC EXPLOSIONPROOF MOTOR STARTERS



AEB Series Bolted Motor Starters and Contactors

Explosionproof, Dust-Ignitionproof, Watertight

Full Voltage. Combination and Non-Combination.

NEC/CEC:

Class I, Division 1 and 2, Groups B, C, D

Class I, Zone 1 and 2, Groups IIB + H₂

Class II, Division 1 and 2, Groups E, F, G

Class III

NEC/CEC:

NEMA 4, 4X, 7BCD, 9EFG

CSA Type 4, 4X

Dimensions in Millimeters (Inches) — Combination

Enclosure Layout for Size 0, 1 and 2 — Combination

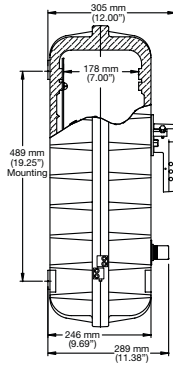

Left Side View

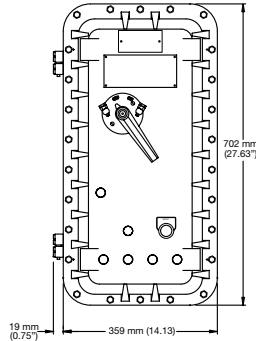

Front View

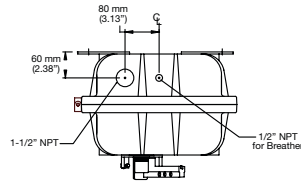

Top View

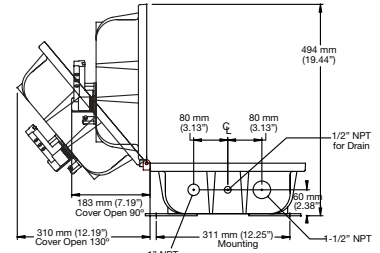

Bottom View

Enclosure Layout for Size 3 and 4 — Combination

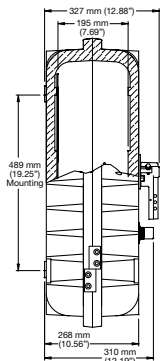

Left Side View

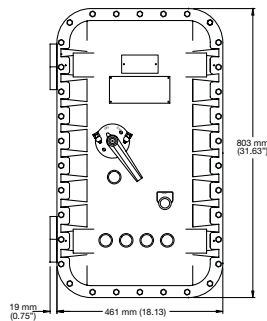

Front View

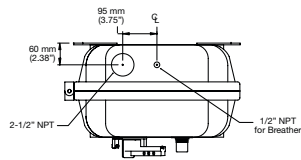

Top View

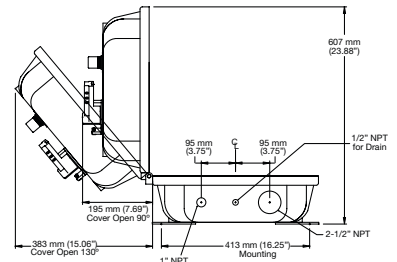

Bottom View

Enclosure Layout for Size 5 — Combination

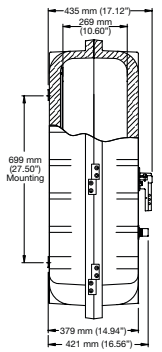

Left Side View

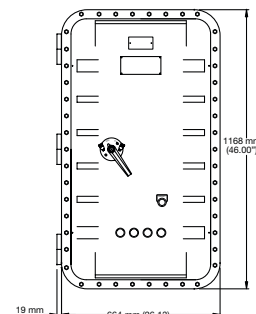

Front View

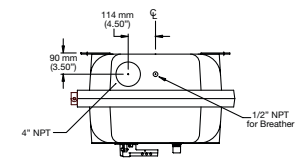

Top View

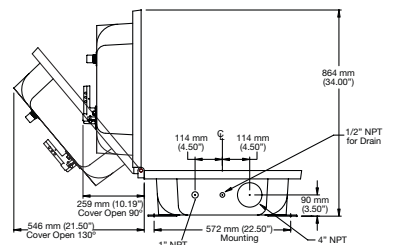

Bottom View

CONTROLS: NEC/CEC EXPLOSIONPROOF MOTOR STARTERS



AEB Series Bolted Motor Starters and Contactors

Explosionproof, Dust-Ignitionproof, Watertight

Full Voltage. Combination and Non-Combination.

NEC/CEC:

Class I, Division 1 and 2, Groups B, C, D
Class I, Zone 1 and 2, Groups IIB + H2
Class II, Division 1 and 2, Groups E, F, G
Class III

NEC/CEC:

NEMA 4, 4X, 7BCD, 9EFG
CSA Type 4, 4X

Lighting Contactor – 3-Pole – 60 Hertz, 120 V Coil

Line Voltage	Enclosure Size	Contactor Amps	Number of Poles	Catalog Number [▲]	Approximate Weight kg (lb)	Conduit Size (Inches)	Mounting Hardware Set Catalog Number
120	1	30	3	AE1BM1S13	57 (125)	1-1/2	AMH7
			6	AE1BM1S16			
			9	AE1BM1S19			
			12	AE1BM1S12			

Wiring Diagram

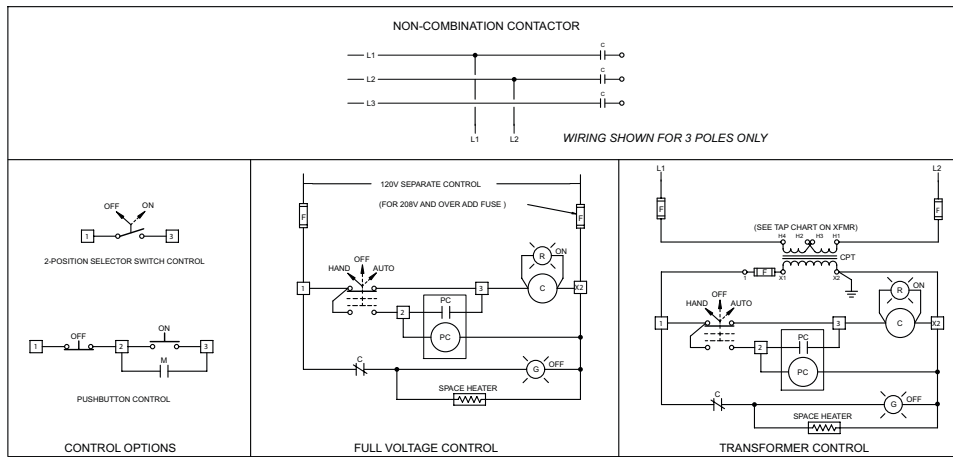

Dimensions in Millimeters (Inches) – Lighting Contactor

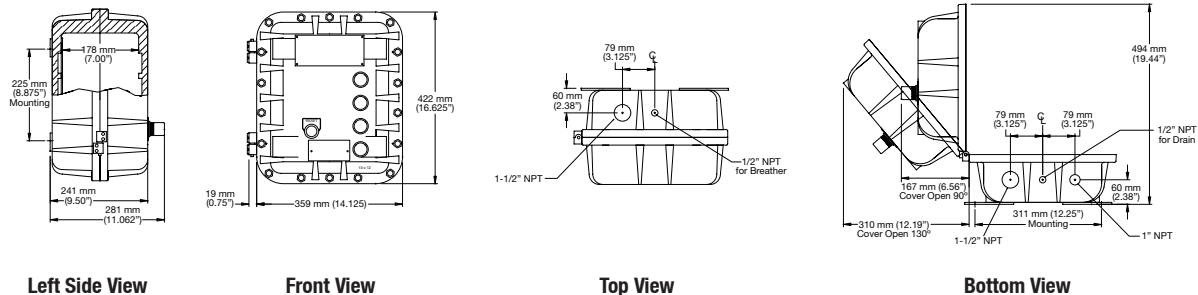

Left Side View

Front View

Top View

Bottom View

▲ To complete the catalog number please add the appropriate suffix for other options/features. Suffixes, see AEB Series Motor Starters Modifications.

AEB Series Bolted Motor Starters and Contactors

Explosionproof, Dust-Ignitionproof, Watertight

Full Voltage. Combination and Non-Combination.

NEC/CEC:

Class I, Division 1 and 2, Groups B, C, D
Class I, Zone 1 and 2, Groups IIB + H₂
Class II, Division 1 and 2, Groups E, F, G
Class III

NEC/CEC:

NEMA 4, 4X, 7BCD, 9EFG
CSA Type 4, 4X

Combination Lighting Contactor – 3-Pole – 60 Hertz, 120 V Coil

Line Voltage	Enclosure Size	Contactor Amps	Contactor Amps	Number of Poles	Catalog Number [▲]	Approximate Weight kg (lb)	Conduit Size (Inches)	Mounting Hardware Set Catalog Number
120	1	30	40	3	AE1BN1S1F3	57 (125)	1-1/2	AMH7
				6	AE1BN1S1F6			
				9	AE1BN1S1F9			
				12	AE1BN1S1F12			

Wiring Diagram

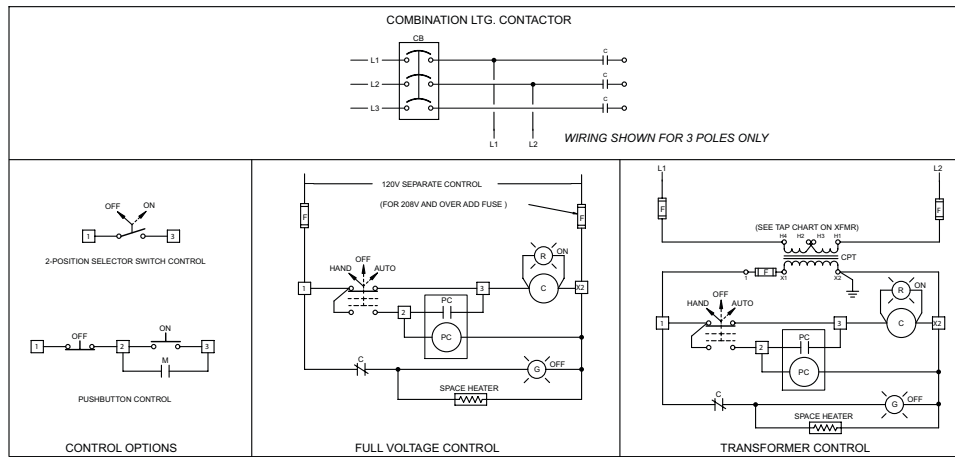

Dimensions in Millimeters (Inches) – Combination Lighting Contactor

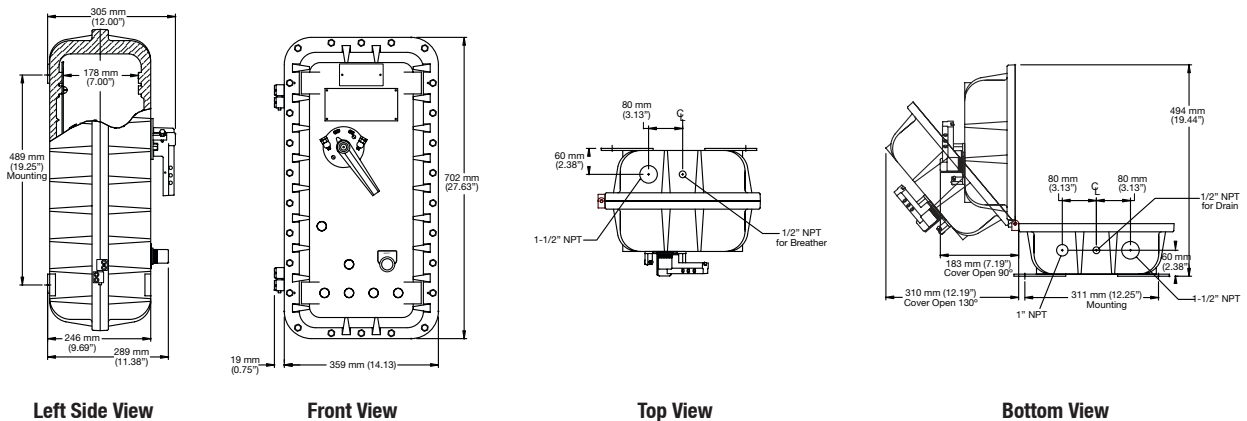

▲ To complete the catalog number please add the appropriate suffix for other options/features. Suffixes, see AEB Series Motor Starters Modifications.

CONTROLS: NEC/CEC EXPLOSIONPROOF MOTOR STARTERS



AEB Series Bolted Motor Starters and Contactors

Explosionproof, Dust-Ignitionproof, Watertight

Full Voltage. Combination and Non-Combination.

NEC/CEC:

Class I, Division 1 and 2, Groups B, C, D
Class I, Zone 1 and 2, Groups IIB + H₂
Class II, Division 1 and 2, Groups E, F, G
Class III

NEC/CEC:

NEMA 4, 4X, 7BCD, 9EFG
CSA Type 4, 4X

Modifications

Description	Suffix Factory Installed	Catalog Number Field Installed
Operators ①		
Start/Stop dual push button	S3X	AEPDGRE
Stop push button	S2X	AEPRC
Start push button	S1X	AEPGA
Stop, lighted PB, red 120 Vac	LP5X	AEPTRE
Start, lighted PB, green 120 Vac	LP4X	AEPTGE
3 position selector switch specify legend	A3X	AESS31MN
2 position selector switch specify legend	A2X	AESS22ML
Red pilot light, 120 Vac	L5	AEPL1R
Green pilot light, 120 Vac	L4	AEPL1G
Red pilot light, 240 Vac	L52	AEPL2R
Green pilot light, 240 Vac	L42	AEPL2G
Red pilot light, 480 Vac	L54	AEPL4R
Green pilot light, 480 Vac	L44	AEPL4G
NEMA 4X Breather/Drain Fittings		
Drain fitting	DN	DRNB4X
Breather fitting (Drilled and tapped installation included.)	BR	BRTB4X
Control Power Options ②③		
Fused CPT, 50 Va	T1	AFCPT050
Fused CPT, 100 Va	T2	AFCPT100
Fused CPT, 200 Va	T3	AFCPT200
Fused CPT, 250 Va	T4	AFCPT250
Fused CPT, 50 Va w/interposing relay	T5	AFCPT050R
Fused CPT, 150 Va	T6	AFCPT150
Fused CPT, 300 Va	T7	AFCPT300
Fused CPT, 500 Va	T8	AFCPT500
Fused CPT, 750 Va	T9	AFCPT750
Separate control fused circuit	S-120V	n/a
Specify starter coil voltage	S-240V	n/a
	S-480V	n/a

Description	Suffix Factory Installed	Catalog Number Field Installed
Nameplates		
Engraved nameplate — black letters on white surface, 50.8 x 101.6 mm (2" x 4"), 3.18 mm (0.125") letters, 3 lines max. specify legend	NP	n/a
Space Heater		
40 Watt enclosure space heaters	120 Vac	O-120V AFA4327X11
	240 Vac	O-240V AFA4327X12
	480 Vac	O-480V AFA4327X13
Control Terminal Blocks (Above 12 points contact your local representative)		
20 Amp, 600 Vac	8 point	8K n/a
NEMA 1B w/wire markers	12 point	12K n/a
Cutler-Hammer + Starter Auxiliary Contacts		
Size 0-4 ④	1NO/1NC	X11C AJ-11
	2NO/2NC	X22C AJ-11 (2 ea.)
Size 5 ⑤	1NO/1NC	X511C A3463D94G18
	2NO/2NC	X522C A3463D94G18 (2 ea.)
Square D * Starter Auxiliary Contacts		
Size 0-5 ⑥	1NO/1NC	X11S A999SX8
	2NO/2NC	X22S A999SX8 (2 ea.)
Number of Poles on Lighting Contactors		
30 Amp, 120 Vac	3 Poles	3
30 Amp, 120 Vac	6 Poles	6
30 Amp, 120 Vac	9 Poles	9
30 Amp, 120 Vac	12 Poles	12

CONTROLS: NEC/CEC EXPLOSIONPROOF MOTOR STARTERS

Appleton

NOTE: **CPT** includes primary and secondary fuses.

① Add —**L** to part no. for Size 5 starters.

② Size 1 and 2 150 Vac Max. Size 3 and 4 300 Vac Max.

③ Contact your local representative for other voltages.

④ 8 Aux. Contacts Max. includes one seal-in and seven added.

⑤ 4 Aux. Contacts Max. includes one seal-in and three added.

⑥ Size 0-1 includes one seal-in and four added. Size 2-5 includes one seal-in and three added.

+ Cutler-Hammer is a registered trademark of Eaton Corporation.

■ Square D is a registered trademark of Schneider Electric.