

# Compression Connector Installation Solutions

XR™ InSITE® RTQ™ NJX™ TLC™ OmniConn™



**NEW**

**XR™ XTENDED RANGE**

The NEW RTQ™ XR™ F Compression Connector accepts RG-6, RG-6 Quad, RG-6 Plenum and RG-6 Quad Plenum in a single connector.



When cable is visible, it's ready to compress!

- RG-59**
- RG-59**  
Plenum
- RG-6**
- RG-6Q**
- RG-6/6Q**  
Plenum
- RG-11**
- RG-11**  
Plenum

**InSITE**  
TECHNOLOGY

Featuring a 360° clear site window that simplifies the connector to cable installation process for fast, confident, and consistent terminations

- Compression solutions for coaxial cables used in HD video and security applications
- **NEW** Xtended Range RTQ™ XR™ F Connector
- InSITE®, NJX™ and TLC™ models
- Right Angle F and BNC connectors
- F/BNC/RCA/RG-11 F-Connectors
- 360° compression optimizes RF performance and mechanical strength for a permanent connection
- Compression solutions for outdoor, indoor and tool-less installations

33-793 Pro XL  
Compression Hip  
Kit



Made in U.S.A. of U.S. and Global Components



# InSITE® Compression Connectors

Installing one-piece compression BNC and right angle connectors just got easier. No more uncertainty when inserting the cable into the connector. No more collapsed center pins. No more wasted connectors and rework time on the job.

With the patented InSITE® Technology feature, standard on our BNC and right angle (90°) compression connectors, field termination of these blind entry connectors is simpler, faster and now provides a higher performance connection for all applications from CCTV to HD Video.

The InSITE® window is a 360° clear window which allows the installer to verify that the prepped cable has been inserted far enough into the connector to make contact with the fixed pin. The cable, which requires a 1/4" x 1/4" industry standard preparation, is inserted into the connector until the folded braiding is visible within the InSITE® window. No measuring, no jacket marking, no guesswork.

In addition to the InSITE® feature, other improvements include:

- Increased compatible ranges of cable jacket diameters
- Lower cable insertion force
- A redesigned funneled pin entry - centers angled pins
- Accepts 23-18 AWG solid center conductor pins
- Smoother and easier mating with sockets through increased BNC head travel range
- Better return loss performance: >35dB up to 1GHz, >25dB up to 2GHz, >20dB up to 3GHz

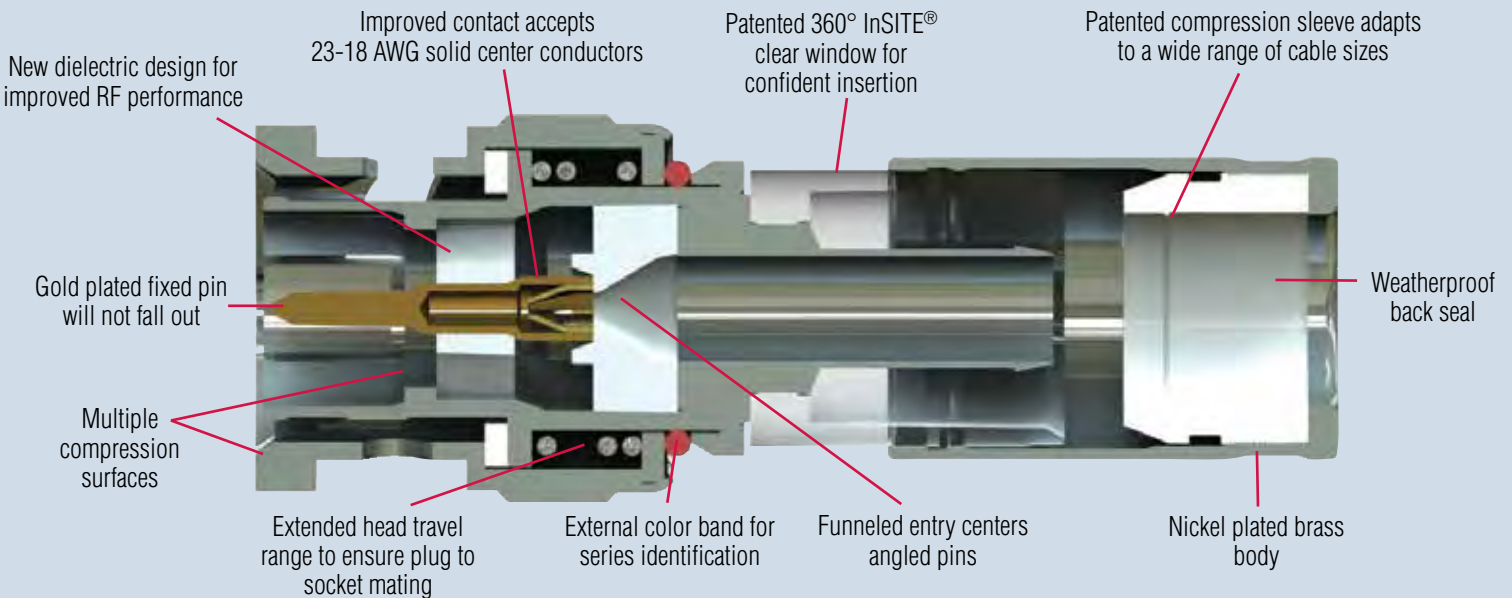



# InSITE<sup>®</sup>

TECHNOLOGY

InSITE<sup>®</sup> Technology gives installers a large, clear 360° visual indication that the coax cable has been correctly and completely inserted into the connector. Unlike connectors that use a sliding center pin contact as an indicator, the gold plated center pin in the InSITE<sup>®</sup> is fixed. The center pin will not fall out of the connector during transport or become loose after repeated connection cycles. The pin can handle a wide 23-18 AWG solid conductor range so fewer connectors are needed for specialty and application specific cables.

- All InSITE<sup>®</sup> connectors feature our patented RTQ<sup>™</sup> compression sleeve giving each of these connectors a weatherproof seal at the cable entry point, keeping out moisture and other contaminants that compromise the mechanical and electrical performance of the connection.
- All InSITE<sup>®</sup> connectors have a 360° compression design which keeps the round dielectric geometry intact and keeps the 75Ω impedance matching to a maximum, resulting in better return loss and lower insertion loss.
- After compression, all InSITE<sup>®</sup> Connectors have a robust, all-brass exterior.
- BNC head design allows the InSITE<sup>®</sup> to mate smoother and easier with the many variations of female BNC connectors found on CCTV cameras, A/V equipment and instrumentation.

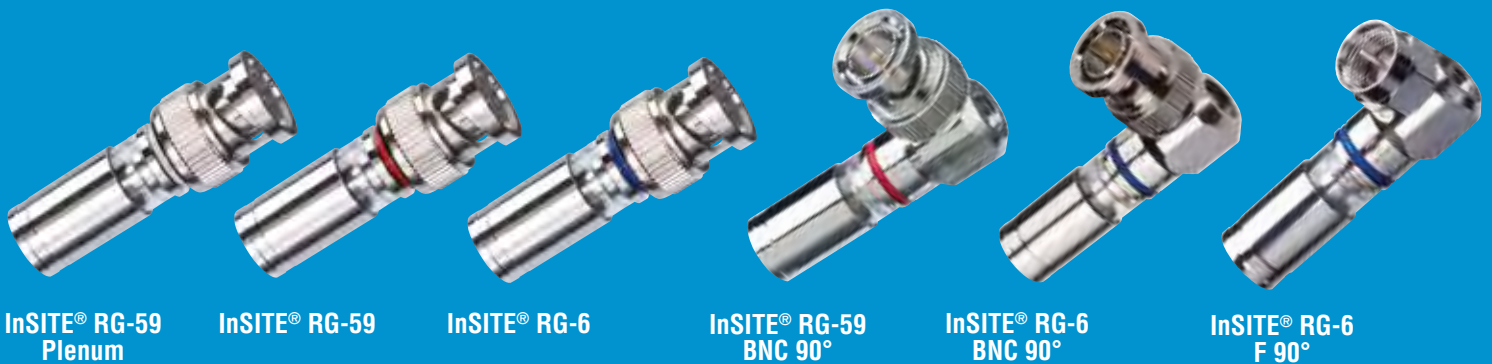

## RTQ<sup>™</sup> XR<sup>™</sup> and RTQ<sup>™</sup> F & RCA Compression Connectors



The New RTQ<sup>™</sup> XR<sup>™</sup> Xtended Range F connector has been designed to work on RG-6 coax cables including Plenum versions. One connector now handles RG-6/RG-6 Quad/RG-6 Plenum and RG-6 Quad Plenum. This universal cable range enables the installer to carry a single connector when working with multiple cable types.

The RTQ<sup>™</sup> series of connectors feature all brass exteriors and a patented compression sleeve. The F connectors incorporate an inner O-ring for a robust weather proof connection suitable for just about any application - indoors or outdoors for installations from 5MHz to 3GHz, including CATV, satellite, HDTV and other A/V based applications.

All RTQ<sup>™</sup> XR<sup>™</sup> and RTQ<sup>™</sup> connectors require a standard 1/4" x 1/4" cable preparation and are permanently attached to the cable when using the IDEAL OmniSeal<sup>™</sup> Pro XL or LinearX<sup>®</sup>3 compression tool.

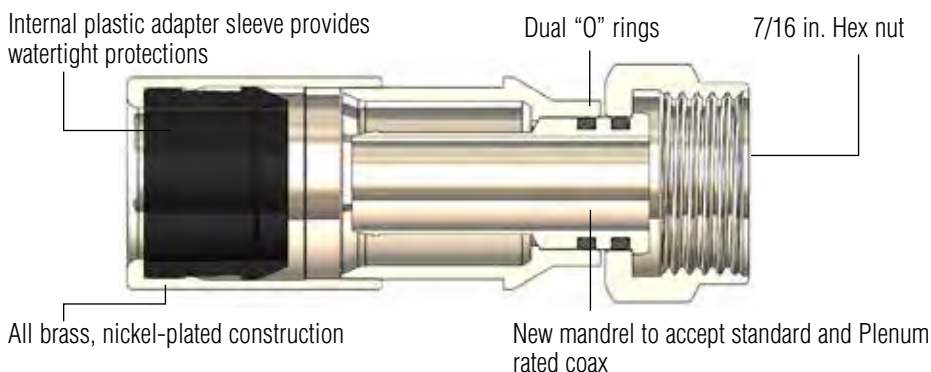

### Pro Compression Starter Kit

Starter kit includes 30-793 OmniSeal<sup>™</sup> Pro XL Compression Tool, Coax PrepPRO<sup>®</sup>, Data T<sup>™</sup>-Cutter, and an assortment of InSITE<sup>®</sup> and RTQ<sup>™</sup> compression connectors and adapters for HD Video and Security applications.



33-639



# F-Compression Connectors

## OmniConn™ F-Compression Connectors

OmniConn™ RG-6 (blue) and RG-6 Quad (black) compression connectors are an economical, cable specific alternate to the RTQ™ series of products. Featuring a weatherproof back seal and front end O-ring to inhibit moisture migration, these are rated for indoor or outdoor use. The two piece brass and plastic body comes pre-assembled for quick field termination and installation. Utilizing the same style patented adapter sleeve as the RTQ™ series, OmniConn™ connectors exceed >40 lbs. of pull force, making your connection permanent. For use in applications from 5MHz to 3GHz.

OmniConn™ RG-6



OmniConn™ RG-6 Quad



## NJX™ F-Compression Connectors

The NJX™ (pronounced “injects”) compression connector offers a high performing, reliable and economical solution designed for applications that do not require weatherproof connectivity. NJX™ is also great for installers looking to upgrade from traditional hex crimp or twist-on coax F termination methods.

Available in F-Type interfaces for RG-6 and RG-6 Quad cables, the NJX™ connectors are an indoor cable specific alternate to the OmniConn™ series of products. NJX™ connectors require the same 1/4” x 1/4” cable preparation and compression termination as all other IDEAL compression connectors. Color coded, injection molded bodies make these connectors lighter, more compact, and more cost effective for installers. Unlike traditional compression connectors that get shorter when compressed, the NJX™ series connectors have a post-forward design, which during compression, is “injected” into the body of the connector. Although these connectors are shorter, they still utilize the same compression settings and stroke length as all IDEAL F-compression connectors. Once compressed, the cable is secured creating a permanent 360° compression ring on the cable. NJX™ connectors are designed for applications from 5MHz to 3GHz including CATV and satellite. For outdoor/weatherproof or universal cable compression products, the RTQ™ series of compression products are recommended.

NJX™ RG-6



**NEW**

NJX™ RG-6 Quad

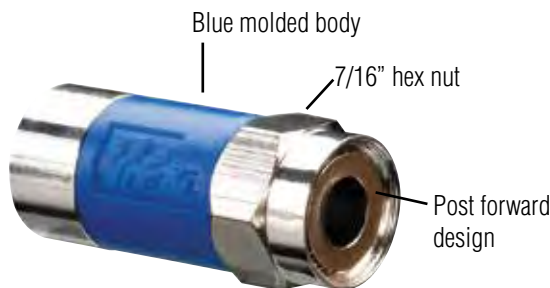

## TLC™ Tool-Less Compression Connectors

TLC™ RG-6



TLC™ RG-6Q





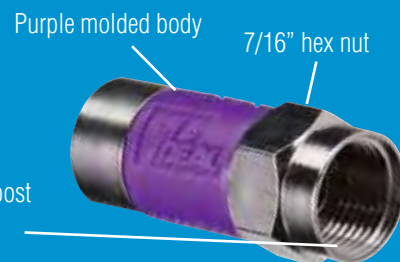
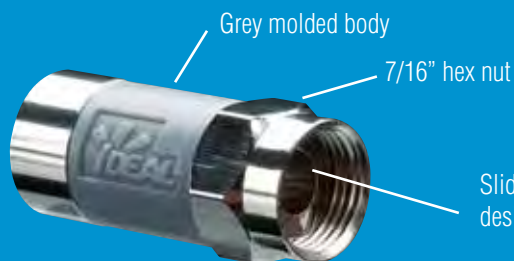















**NEW**

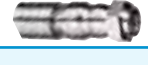

The TLC™ (Tool-Less Compression) RG-6 and RG-6 Quad F compression connectors are our simplest, fastest and lowest total cost solution for installing compression connectors. Designed to save the installer **Time, Labor, and Cost** when installing indoor RG-6 F-Type connections **no compression tool is required** to terminate these connectors.

The TLC™ connector is an indoor, cable specific alternate to the NJX™ series of products. The TLC™ connector uses the standard 1/4” x 1/4” cable preparation, that does not require a compression tool to complete the termination process. TLC™ series connectors feature a sliding post design to capture and secure the cable inside of the connector. After the cable is inserted, tightening the connector to the device completes assembly process, creating a 360° compression point and a permanent connection. IDEAL F/BNC insertion tool (35-046) can be used (but are not required) when installing the TLC™ cable assembly to ensure connectors are properly torqued and fully seated to the female barrel. These connectors are designed for applications from 5MHz to 3GHz including CATV and satellite.

# Compression Connectors

Type		Image	Series/Model #	Cable Type	Center Conductor	Dielectric Diameter	Jacket Diameter	Quantity	Cat. No
BNC	RG-59		InSITE™ Model #59BNCIS	RG-59	23-18 AWG Solid .023" - .040"	.142" - .148"	.230" - .250"	Card of 4	<b>92-704</b>
								Card of 15	<b>89-047</b>
								Jar of 35	<b>89-5047</b>
								Bulk 1,000	<b>89-1047</b>
			InSITE™ 90° Model #59BNCRAIS	RG-59	23-18 AWG Solid .023" - .040"	.142" - .148"	.230" - .250"	Card of 5	<b>92-693</b>
			InSITE™ Model #59PLBNCIS	RG-59 Plenum	23-18 AWG Solid .023" - .040"	.134" - .140"	.193" - .224"	Card of 15	<b>89-049</b>
	RG-6		InSITE™ RTQ™ Model #6BNCISRTQ	RG-6/6Q RTQ™ & Plenum 6/6Q RTQ™	23-18 AWG Solid .023" - .040"	.168" - .183"	.226" - .305"	Card of 4	<b>92-705</b>
								Card of 15	<b>89-048</b>
								Jar of 35	<b>89-5048</b>
			InSITE™ 90° Model #6BNCRAISRTQ	RG-6/6Q RTQ™ & Plenum 6/6Q RTQ™	23-18 AWG Solid .023" - .040"	.168" - .183"	.226" - .305"	Card of 5	<b>92-695</b>
Any		BNC 75Ω Adapter Model #75BNCFF	75Ω	—	—	—	Card of 2	<b>85-075</b>	
							Card of 10	<b>92-817P</b>	
F	RG-6		RTQ™ XR™ Model #6FRTQXR	RG-6/6Q RTQ™ & Plenum 6/6Q RTQ™	—	.168" - .183"	.226" - .310"	Card of 10	<b>92-651</b>
								Jar of 50	<b>92-650</b>
								Jar of 100	<b>92-656</b>
								Bulk 1,000	<b>92-659</b>
			InSITE™ RTQ™ 90° Model #6FRAISRTQ	RG-6/6Q RTQ™ & Plenum 6/6Q RTQ™	23-18 AWG Solid .023" - .040"	.168" - .183"	.226" - .305"	Card of 5	<b>92-691</b>
			NJX™ Model #6FNJX	RG-6	N/A	.175" - .183"	.254" - .278"	Card of 10	<b>89-040</b>
			NJX™ Model #6QFNJX	RG-6 Quad	N/A	.175" - .183"	.275" - .305"	Card of 10	<b>89-041</b>
			TLC™ Model #6FTLC	RG-6	N/A	.175" - .183"	.254" - .278"	Card of 10	<b>85-068</b>
								Card of 50	<b>85-168</b>
			TLC™ Model #6QFTLC	RG-6 Quad	N/A	.175" - .183"	.275" - .305"	Card of 50	<b>85-178</b>
			OmniConn™ Model #6FOC	RG-6	N/A	.175" - .183"	.260" - .280"	Jar of 50	<b>89-044</b>
								Bulk 1,000	<b>89-1544</b>
			OmniConn™ Model #6QFOC	RG-6 Quad	N/A	.175" - .183"	.270" - .295"	Jar of 50	<b>89-045</b>
	RG-59		RTQ™ Model #59FRTQ	RG-59/59Q RTQ™	N/A	.142" - .148"	.230" - .270"	Card of 10	<b>92-611</b>
								Jar of 50	<b>92-610</b>
RG-11		RTQ™ Model #11FISRTQ	RG-11 RTQ™ RG-11 Quad	18-14 AWG Solid .040" - .066"	.280" - .285"	.390" - .416"	Card of 10	<b>89-211</b>	
							Bulk 500	<b>89-1211</b>	
		Cable Specific Model #11PLFIS	RG-11/11Q Plenum	18-14 AWG Solid .040" - .066"	.270" - .280"	.340" - .356"	Card of 10	<b>92-212</b>	
Any		F-81 Adapter 3GHz Model 753GFFF	75Ω	—	—	—	Card of 4	<b>85-339</b>	
							Card of 10	<b>85-340</b>	
RCA	RG-59		RTQ™ Model #59RCARTQ	RG-59/59QRTQ™	20-18 AWG Solid .029" - .040"	.142" - .148"	.230" - .270"	Jar of 35	<b>89-570</b>
	RG-6		RTQ™ Model #6RCARTQ	RG-6/6Q RTQ™	20-18 AWG Solid .029" - .040"	.175" - .183"	.267" - .305"	Jar of 35	<b>89-580</b>





# Compression Tools

## OmniSeal™ Pro XL Compression Tool



**Three levels of compression surfaces. No adapter or post adjustment needed for IDEAL F/BNC/RCA/11F**



All IDEAL compression connectors are compatible with our flagship OmniSeal™ Pro XL (30-793) compression tool. Unlike most compression tools which require adjustments and adapters for each type of connector, this compact 6¾" length tool compresses nearly all IDEAL compression connectors with no adjustments to the tool. F/BNC/RCA/RG-11 F connectors can all be terminated one after another with no setting changes. Only the 90° connectors require the post to be lowered. Patented dual spring clips and fixed top ledge enable this tool to compress more connectors than any other tool on the market.

The adjustable spin knob allows for compressive forces to be placed on the rim of the connector instead of the bottom of the nut when required. This is helpful for non-IDEAL plastic centered connectors such as 50Ω BNC's or RCA's with limited structural support. It can also be used as a larger flat surface to compress against for other types of non-traditional compression connectors.

The adjustable post and spin knob, combined with three compression surface levels, give the installer virtually unlimited options for compressing current and future connector designs.



### Upgrade to the Pro XL Hip Kit!

Includes OmniSeal™ Pro XL Compression Tool, PrepPro™ Coax (59/6/6Q)/UTP stripper, Data-T® Cutter, and Pouch with belt clip. Cut, strip and terminate in one handy professional tool kit.



33-793

Adjusted post for IDEAL 90° connectors

Level 2

90°

# LINEAR<sup>®</sup> Compression Tool

LinearX<sup>®</sup>3 brings several of the qualities, features and workmanship of our professional OmniSeal™ Pro Series of tools into a smaller, simpler, value-priced tool. This tool is designed for installers that are converting from traditional crimping tools or those that occasionally work with coaxial cable terminations. An all metal, zinc die cast frame construction with a double dipped no-slip, spring loaded handle and embossed logo are just a few of the high quality features and finishes found on the LinearX3 that are typically absent on value priced tools.



**LinearX<sup>®</sup>3 adjustable post**

The LinearX<sup>®</sup>3 has an adjustable post and is designed to compress F/BNC/RCA connectors. The post can be raised or lowered to accommodate different sizes and types of compression connectors.



## Upgrade to the LinearX<sup>®</sup> Hip Kit!

Cut, strip and terminate F connectors in one handy starter tool kit. Includes LinearX<sup>®</sup>3 Compression Tool, PrepPro<sup>®</sup> Coax (59/6/6Q) stripper, Data-T<sup>®</sup> Cutter, and Pouch with clip.

33-622



## Connector & Tool Compatibility Chart

Type	IDEAL Connector	OmniSeal™ Pro XL 30-793	LinearX <sup>®</sup> 3 33-632
F	F 6 RTQ™ XR™	✓	✓
	F 6 RTQ™ 90°	✓	✓
	F 59 RTQ™	✓	✓
	F 6 NJX™	✓	✓
	F 6Q NJX™	✓	✓
	F 6/6Q OmniConn™	✓	✓
11F	F 11 RTQ™	✓	—
	F 11 Plenum	✓	—
BNC	BNC 59	✓	✓
	BNC 59/6 90°	✓	✓
	BNC 59 Plenum	✓	✓
RCA	BNC 6 RTQ™	✓	✓
	RCA 59	✓	✓
	RCA 6	✓	✓

✓ No tool adjustment needed. ✓ Tool adjustment needed. — Not compatible.

## Compression Tools

Tool Only	Cat. No.
OmniSeal™ Pro XL	30-793
LinearX <sup>®</sup> 3	33-632
Tool Hip Kits	Cat. No.
OmniSeal™ Pro XL Hip Kit: 30-793, OmniSeal™ Pro XL, 45-605 PrepPro <sup>®</sup> , 45-074 Data T <sup>®</sup> -Cutter, Pouch	33-793
LinearX™3 Hip Kit: 33-632 LinearX <sup>®</sup> 3, PrepPro <sup>®</sup> 45-605, 45-074 Data T <sup>®</sup> -Cutter, Pouch	33-622

## F/BNC Installation and Removal Tool

Use this handy tool to tighten or loosen F or BNC connectors to a mating device. Great for hard to reach locations and right spaces. The patented design allows one tool to work on both F and BNC connectors. Tool has a 3" shaft and 8" overall length. Contoured handle with textured non-slip grip provides comfort and a professional appearance. The tool also includes a threaded post for F connectors. The post provides leverage when inserting F connectors on to the prepped cable.



35-046



# Cable Preparation Stripping Tools

All IDEAL compression connectors require a standard 1/4" X 1/4" cable preparation. This preparation (see instructions below) leaves 1/4" of the center conductor exposed and an additional 1/4" of the shielding exposed. Prep tools are available in single, two or three blade models. Two blade models are the most commonly used type of stripping tool for coax compression as they remove both 1/4" sections at one time during the prep. Single blade models require two separate stripping actions for cable preparation. IDEAL has several models of cable preparation tools that are compatible with compression connectors, each having various feature choices such as user adjustable blade depths, replaceable blades, number of active blades, product size and hand motion required to prep the cable. Use the compatibility chart below to identify a tool that meets your preferences and installation requirements.

45-605 *PrepPRO*<sup>®</sup>



45-526 *Adjustable 2-Blade*  
45-520 *Adjustable 3-Blade*



45-165 *Coax Ringer*



45-111 *RG-11 Coax*



45-074 *Data T<sup>®</sup>-Cutter*



45-262 *Stripmaster<sup>®</sup> Wire Stripper RG-6*  
45-282 *Stripmaster<sup>®</sup> Wire Stripper RG-6 Quad*  
45-265 *Stripmaster<sup>®</sup> Wire Stripper RG-59*



## Cable Prep Tool & Coax Compatibility Chart

IDEAL Cat. No.	# Active Blades	Prep Dimensions	Adjustable Blades	Replaceable Blades	RG-6	RG-6 Quad	RG-6 Plenum	RG-6 Plenum Quad	RG-59	RG-59 Quad	RG-59 Plenum	RG-59 Plenum Quad	RG-11	RG-11 Quad	RG-11 Plenum	RG-11 Plenum Quad	Cuts Coax
45-605	2	1/4" x 1/4"	—	✓	✓	✓	✓	✓	✓	✓	✓	✓	—	—	—	—	—
45-526	2	1/4" x 1/4"	✓	✓	✓	✓	✓	✓	✓	✓	✓	✓	—	—	—	—	—
45-520	3	1/4" x 1/4" x 1/4"	✓	✓	✓	✓	✓	✓	✓	✓	✓	✓	—	—	—	—	—
45-262	1	Variable	—	✓	✓	—	—	—	—	—	—	—	—	—	—	—	—
45-282	1	Variable	—	✓	—	✓	—	—	—	—	—	—	—	—	—	—	—
45-265	1	Variable	—	✓	—	—	—	—	✓	—	—	—	—	—	—	—	—
45-165	2	1/4" x 1/4"	✓	✓	✓	—	✓	✓	✓	✓	✓	✓	—	—	—	—	—
45-111	2	1/4" x 1/4"	—	—	—	—	—	—	—	—	—	—	✓	✓	✓	✓	—
45-074	1	Cutter	—	—	—	—	—	—	—	—	—	—	—	—	—	—	✓

## Compression Cable Prep Instructions



Start with a clean piece/fresh cut of coax.



Prep/strip cable to size.



Fold back braiding. Leave inner foil intact. For Quad, remove outer foil layer.



Check for flush dielectric and no visible wrapped braiding strands.



Fully compress the connector with appropriate tool.



Connect to device. Use the F/BNC insertion tool if needed to reach proper tightening torque.

## Test your cable installation...

Verify your installation with a wiremap and continuity test or locate existing cables with the Test-Tone-Trace Kit (33-866). An all in one test kit for testing, toning and tracing F / BNC / and RCA cables. Also tests RJ-45 and RJ-11 twisted pair cables for opens, shorts, split pairs, miswires and reversals.



33-866

### IDEAL INDUSTRIES, INC.

1375 Park Avenue, Sycamore, IL 60178, USA / 815-895-5181 • 800-435-0705 in USA

International offices:

Australia • Brazil • Canada • China • Germany • Mexico • UK

For complete sales office contact information, visit us at:

[www.idealind.com](http://www.idealind.com)