



LED Lighting Solutions

Floodlighting

Motion Sensors

Wallpacks

Dusk-to-Dawn

Life Safety

Vaportites

Lightscaper

Ceiling / Surface

Industrial Highbay / Lowbay

LED Downlighting

# EXPRESSLINE



## New LED Solutions

Hubbell Lighting's **ExpressLine** product offering is a collection of our most popular items including our expanding offering of LED wallpacks, floodlights, life safety and recessed downlight products (more below). Maximize your energy savings and reduce maintenance costs with the latest products.

LED Products  
Life Safety Products  
Landscape Lighting  
LED Downlighting

Floodlighting  
Wallpacks  
Worklights  
Ceiling/Surface

Motion Sensors  
Dusk-To-Dawn  
Walkway & Path  
Industrial Bay Lights

Lamp Holders  
Vaportites  
LED Highbays

## Stock, Quick-Ship and Made-to-Order

Many **ExpressLine** items are stocked for immediate shipment while offering competitive pricing and great performance. Additionally, select items are included in our Quick-Ship 5, Quick-Ship 10 programs as well as Made-to-Order. Products throughout the catalog are marked with icons below defining availability.

**STOCK** In stock products ship – 1 to 2 days



**5-Day Quick Ship Ordering Guide**  
Order Limit Per Fixture Selection: 15 – BC Pkg Code

**MADE-TO-ORDER** Standard 4 to 6 week lead time



**10-Day Quick Ship Ordering Guide**  
Order Limit Per Fixture Selection: 15 – BC Pkg Code

## ExpressLine Merchandising and Product Information

**ExpressLine** program products offer full color and single color cartons for select high volume products for point-of-purchase merchandising. Product packaging information is provided in modules located on product pages throughout the full-line catalog. **ExpressLine** items are packaged according to their likelihood of being used for merchandising and POP advertisement. All items will fall into one of the following categories which are noted along with the product ordering information.



PACKAGING	PKG. CODE	DESCRIPTION
Full Color Carton	FCC	High impact multi-language cartons (four color with bright blue background) for simplified product selection including application guides, detailed product features, descriptions, and color photography. All cartons include bar codes (UPC) for inventory management.
Single Color Carton	SCC	Vibrant blue and white colored cartons (one or two color) to complement HLI's full color cartons. Product descriptions include basic information, basic features, and product line art. All cartons include bar codes (UPC) for inventory management.
Brown Carton	BC	Traditional brown craft carton with branded label including material number, basic description, wattage, and lamp type. Select products (those stocked by Hubbell Lighting) include bar codes (UPC) for inventory management.
Clear Poly Bag	CPB	Used exclusively for small items where product damage from mishandling isn't likely. All products include branded labels with the material number. Select products (those stocked by Hubbell Lighting) include bar codes (UPC) for inventory management.
Protective Wrapper	PW	Used exclusively for large items too bulky for traditional cartons. An examples would be a steel floodlight bracket. All products include branded labels with the material number. Select products (those stocked by Hubbell Lighting) include bar codes (UPC) for inventory management.

# New Features, LED Products Equivalency

Each LED product in the ExpressLine catalog includes complete information in easy to read modules. Information specific to energy-efficiency, LED performance, traditional luminaire source equivalency, and CCT are available for each product.



Series Number	Equivalency			Delivered Lumens	System Watts	Energy Savings	Mounting Height	CCT	Voltage	Drivers/Current	PKG. CODE
	MH	HPS	CFL								
GSL-15L	150w	150w	84w+	4524	53.3	72%	8-12 ft.	4000K	120-277V	1@1050mA	BC
GSL-21L	250w	250w	84w+	6138	74	54%	12-15 ft.	4000K	120-277V	1@1050mA	BC

Equivalent traditional light sources

Total watts consumed by luminaire

Suggested application

Voltage range options

Maximum lumens produced by luminaire

Percentage of energy savings over traditional light sources

(CCT) Correlated Color Temperature

Number of drivers and drive current

Industry listings, energy-efficiency and environmental qualifications

Code for type of product packaging (see page 2)

## Contents

<b>FLOODLIGHTING</b>	LED FLOODLIGHTING.....	4
	HID FLOODLIGHTING .....	12
	WORKLIGHTS .....	19
	MOTION SENSORS .....	20
<b>ACCESSORIES</b>	FLOODLIGHT MOUNTING ACCESSORIES .....	21
	PHOTOCONTROLS .....	23
<b>WALLPACKS</b>	LED ZERO UPLIGHT WALLPACKS.....	24
	LED REFRACTOR WALLPACKS.....	26
	HID ZERO UPLIGHT WALLPACKS.....	30
	HID REFRACTOR WALLPACKS .....	34
<b>CEILING/SURFACE</b>	LED CEILING/SURFACE .....	40
	HID CEILING/SURFACE.....	42
<b>CANOPY</b>	HID CANOPY .....	46
<b>ROADWAY</b>	LED ROADWAY.....	47
	HID ROADWAY .....	49
<b>SECURITY</b>	LED DUSK-TO-DAWN.....	52
	HID DUSK-TO-DAWN .....	54
<b>VAPORTITES</b>	VAPORTITES.....	55
<b>LANDSCAPE</b>	LANDSCAPE (12V LED) .....	57
	WALKWAY & PATH (120V).....	59
	LAMP HOLDERS.....	60
<b>HIGHBAY/LOWBAYS INDUSTRIAL VAPORTITES</b>	LED HIGHBAY INDUSTRIAL .....	64
	HID HIGHBAY/LOW BAY .....	66
	INDUSTRIAL VAPORTITES .....	67
<b>DOWNLIGHTING</b>	LED DOWNLIGHTING .....	68
<b>LIFE SAFETY</b>	EXIT SIGNS/EMERGENCY LIGHTING .....	72
	PRODUCT INDEX.....	82



# FSL

## Decorative Flood

LED FLOODLIGHTING



- Ultra-compact size measuring only 4.5" x 7.5" x 4"
- Wide flood NEMA 6 x 6 distribution for general purpose flood and facade lighting
- Traditional 1/2" x 14 NPS threaded adjustable knuckle mounting
- 120-277V operation (PC version 120V only)
- Rugged die-cast aluminum housing with dark bronze finish
- Vented housing isolates LED module from driver maximizing product life and performance
- High impact UV stabilized acrylic outer lens protects LEDs and allows for cleaning and debris removal
- DesignLights Consortium (DLC) qualified
- IP66, listed to UL1598 for use in wet locations
- Four color multi-language merchandising carton with application details
- Visor and vandal shield available

### STOCK

### ORDERING INFORMATION

Catalog Number	Mount	Beam Pattern	Wattage	# Drivers/ Current	Voltage	Color Temperature	Lumens	LPW	Weight lbs. (kg)	PKG. CODE
FSL-7	1/2" thread	Wide	26.5	1@1050mA	120-277V	5000K	2040	77	6 (2.7)	FCC
FSL-7-PC1	1/2" thread	Wide	26.5	1@1050mA	120V	5000K	2040	77	6 (2.7)	FCC

### EQUIVALENCY INFORMATION

Equivalency			Energy Savings
MH	HPS	CFL	
100w	100w	42w	82%

### STOCK

### ACCESSORIES/REPLACEMENT PARTS - (ORDER SEPARATELY)

Catalog Number	Description
FSL-SPC	Polycarbonate shield/lens (Replaces existing acrylic lens)
FSL-VISOR-DB	Top/bottom visor (Tap holes in lens frame for field installation)
93047942AC	Acrylic lens w/ gasket
93047957	25w, 120-277V Dimming driver, 1040mA
20750110264	Knuckle mount Dark Bronze finish; Contact factory for additional finishes
S-302-M51	Slipfits 1 1/2" or 2" pipe (1.9" OD or 2 3/8" OD) with 1/2" N.P.S.M. hub; Bronze

### DIMENSIONS

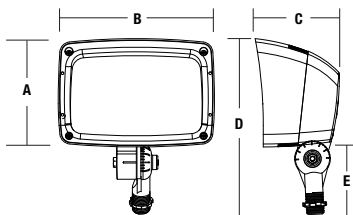

A	B	C	D	E	Weight
5.125"	7.5"	4"	8.625"	3.5"	6 lbs.
130 mm	190 mm	102 mm	219 mm	89 mm	2.7 kg



- Compact size measuring only 6.7" x 9.6" x 4.5"
- Wide flood NEMA 6 x 6 distribution for general purpose flood and facade lighting
- Traditional 1/2" x 14 NPS threaded adjustable knuckle mounting
- 120-277V operation (PC version 120V only)
- Rugged die-cast aluminum housing with dark bronze finish
- DesignLights Consortium (DLC) qualified
- High impact UV stabilized acrylic outer lens protects LEDs and allows for cleaning and debris removal
- IP65, listed to UL1598 for use in wet locations
- Four color multi-language merchandising carton with application details
- Visor and vandal shield available
- Vented housing isolates LED module from driver maximizing product life and performance



### STOCK ORDERING INFORMATION

Catalog Number	Mount	Beam Pattern	Wattage	# Drivers/Current	Voltage	Color Temperature	Lumens	LPW	Weight lbs. (kg)	PKG. CODE
FML-14	1/2" thread	Wide	53	1@1050mA	120-277V	5000K	4285	81	8.5 (3.8)	FCC
FML-14-PC1	1/2" thread	Wide	53	1@1050mA	120V	5000K	4285	81	8.5 (3.8)	FCC

### EQUIVALENCY INFORMATION

Equivalency			Energy Savings
MH	HPS	CFL	
150w	150w	2x42w	78%

### STOCK ACCESSORIES/REPLACEMENT PARTS - (ORDER SEPARATELY)

Catalog Number	Description
FML-SPC	Polycarbonate shield/lens (Replaces existing acrylic lens)
FML-VISOR-DB	Top/Bottom visor (Tap holes in lens frame to field install)
93047961AC	Acrylic lens w/ gasket
93047971	50w, 120-277V Dimming driver, 1040mA
20750110264	Knuckle mount Dark Bronze finish; Contact factory for additional finishes
S-302-M51	Slipfits 1 1/2" or 2" pipe (1.9" OD or 2 3/8" OD) with 1/2" N.P.S.M. hub; Bronze

### DIMENSIONS

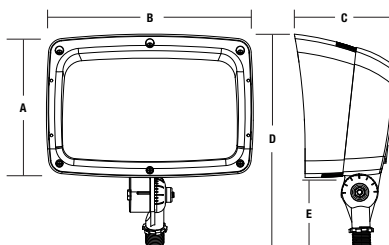

A	B	C	D	E	Weight
6.7"	9.6"	4.5"	10.20"	3.5"	8.5 lbs.
169 mm	224 mm	115 mm	259 mm	89 mm	3.8 kg

## Large Decorative Flood



- Large LED flood with wide beam NEMA 6 x 6 distribution for lighting applications such as safety/security, facade, area, or signs; operating temperature range -35°C to 40°C
- 28 high powered LEDs deliver 8054 lumens
  - 5000K CCT, 67 CRI
  - Rugged die-cast aluminum housing with dark bronze finish
  - Tempered glass lens protects LEDs and allows for cleaning/debris removal
  - Visor accessory available

- Vented housing isolates LED module from driver, maximizing product life and performance
- 120-277V operation, 50/60Hz, 100w, 1050mA
- DesignLights Consortium (DLC) qualified
- IP65, listed to UL1598 for use in wet locations
- Driver RoHS compliant and IP66
- 0-10V Dimming driver
- Traditional adjustable yoke mounting
- 3' SE00W cord

### STOCK ORDERING INFORMATION

Catalog Number	Mount	Max Candle Power	Beam Pattern	Wattage	# Drivers/Current	Voltage	Color Temperature	Lumens	LPW	Weight lbs. (kg)	PKG. CODE
FLL-28L	Yoke	5508	Wide	100w	1@1050mA	120-277V	5000K	8054	80.5	20 (9.0)	FCC

### EQUIVALENCY INFORMATION

Equivalency			Energy Savings
MH	HPS	CFL	
250w	250w	2x42w+	50%

### STOCK ACCESSORIES/REPLACEMENT PARTS - (ORDER SEPARATELY)

Catalog Number	Description
FLL-VISOR-DB	Top visor (Tap holes in lens frame for field installation)
93058186	96w, 120-277V Dimming driver, 1050mA (1 Qty)

### DIMENSIONS

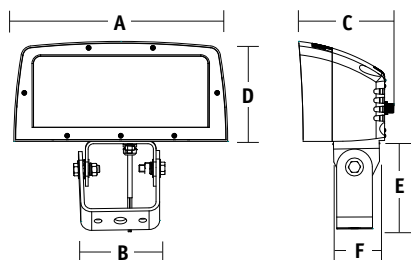

A	B	C	D	E	F	Weight
15"	5.5"	6.0"	7.0"	6.24"	3.3"	20.6 lbs.
378 mm	140 mm	152 mm	177 mm	158 mm	84 mm	9.3 kg

## Large Decorative Flood

LED FLOODLIGHTING

- Extra large LED flood with wide beam NEMA 6 x 6 distribution for lighting applications such as safety/security, facade, area, or signs; operating temperature range -35°C to 40°C
- 56 high powered LEDs deliver 16358 lumens
- 5000K CCT, 67 CRI
- Rugged die-cast aluminum housing with dark bronze finish
- Tempered glass lens protects LEDs and allows for cleaning/debris removal
- Visor accessory available

- Vented housing isolates LED module from driver, maximizing product life and performance
- 120-277V operation, 50/60Hz, 200w, 1050mA
- DesignLights Consortium (DLC) qualified
- IP65, listed to UL1598 for use in wet locations
- Driver RoHS compliant and IP66
- 0-10V Dimming driver
- Traditional adjustable yoke mounting
- 3' SE00W cord



### STOCK ORDERING INFORMATION

Catalog Number	Mount	Max Candle Power	Beam Pattern	Wattage	# Drivers/Current	Voltage	Color Temperature	Lumens	LPW	Weight lbs. (kg)	PKG. CODE
<b>FXL-56L</b>	Yoke	10872	Wide	200w	1@1050mA	120-277V	5000K	16358	82	32 (14.5)	FCC

### EQUIVALENCY INFORMATION

Equivalency			Energy Savings
MH	HPS	CFL	
400w-750w	400w	2x42w+	50%

### STOCK ACCESSORIES/REPLACEMENT PARTS - (ORDER SEPARATELY)

Catalog Number	Description
<b>FLL-VISOR-DB</b>	Top/Bottom visor (Tap holes in lens frame for field installation)
<b>93058186</b>	96w, 120-277V Dimming driver, 1050mA (2 Qty per fixture)

### DIMENSIONS

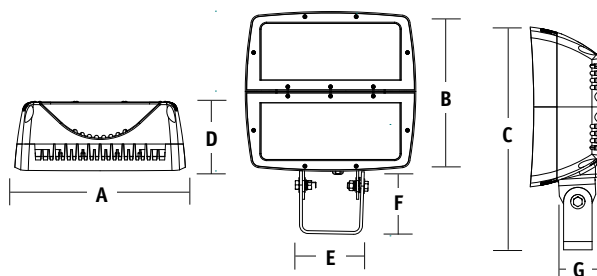

A	B	C	D	E	F	G	Weight
15"	14.0"	19.6"	6.0"	5.5"	6.24"	3.3"	36.2 lbs.
380 mm	356 mm	498 mm	152 mm	139 mm	158 mm	84 mm	16.4 kg



**HUBBELL**  
Outdoor Lighting

# MHS

## Miniliter® LED Series

LED FLOODLIGHTING



MHS YOKE MOUNT



Hubbell Outdoor Lighting's proven Miniliter® MHS features multiple beam patterns and color temperatures, two mounting options, a rugged design and the highest energy efficiency to solve your floodlighting needs.

Energy-efficient LED floodlight for sign, facade, area, accent and general security lighting.

- Die-cast aluminum housing and door, rugged, corrosion resistant and compact
- Tempered, impact resistant glass lens
- Tool-free entry for easy maintenance – twin stainless steel latches
- Protective dark bronze powder paint finish
- Effective projected area (EPA) is 1.4 sq. ft.
- 30 high powered LEDs deliver up to 6200 lumens at 700mA with 88 LPW efficacy
- Different lenses offer a variety of beam spreads

- Narrow, Medium, Rectangular and Wide
- 10KA, 10KV surge protection included
- 3000K, 4000K, and 5000K CCT
- Silicone lens/door gasket provides positive seal
- Electronic driver 71w system. 0.4 AMPS max, 120-277V, 50/60Hz, 0-10V dimming
- Flat glass lens protects LEDs and allows easy cleaning and debris removal
- Steel yoke (MHS-Y) with three-hole pattern allows versatile mounting
- Cast aluminum knuckle (MHS-K) slip-fits 2 3/8" OD tenons/pipe, provides concealed wiring for appearance and safety
- Listed to UL1598 for use in wet locations
- 4K and 5K models DesignLights Consortium (DLC) qualified, consult DLC website for more details: <http://www.designlights.org/QPL>

### ORDERING INFORMATION



**5-Day Quick Ship Ordering Guide**  
Order Limit Per Fixture Selection: 15 – BC Pkg Code

Catalog Number	Description	CCT	Lumens	Watts
MHS-Y-30LU-5K-W-BZ	Flood, Yoke, 30 LED, 120-277V, Wide Beam, Bronze	5000K	6164	71

### ORDERING INFORMATION



**10-Day Quick Ship Ordering Guide**  
Order Limit Per Fixture Selection: 15 – BC Pkg Code

FAMILY	MOUNTING	# LEDS	VOLTAGE	CCT	BEAM	FIXTURE COLOR	OPTIONS
MHS	Y Yoke K Knuckle	30L	U 120V-277V	4K 4000K, 70 CRI 5K 5000K, 67 CRI	N Narrow (Narrow 3x3) M Medium (Wide 3x3) W Wide (6x6)	BZ Bronze	PC1 Button photocontrol 120V PC2 Button photocontrol 277V

### DIMENSIONS

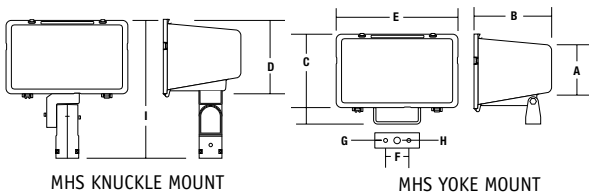

A	B	C	D	E	F	G	H	I	Weight
6 1/2"	14 1/2"	12"	9 7/8"	16 1/4"	3 1/8"	17/32"	7/8"	17"	20 lbs.
165 mm	368 mm	305 mm	251 mm	413 mm	79 mm	14 mm	22 mm	432 mm	(9.1) kgs.

**MADE-TO-ORDER ORDERING INFORMATION – (BC PKG CODE)**

<b>MHS</b>		<b>30L</b>							
FAMILY	MOUNTING	# LEDS	VOLTAGE <sup>1</sup>	CCT <sup>2</sup>	BEAM	DRIVE CURRENT	FIXTURE COLOR	PC	OPTIONS
MHS	Y Yoke K Knuckle	30L	U 120V-277V 1 120V 2 208V 3 240V 4 277V 5 480V F 347V	3K <sup>2</sup> 3000K, 80 CRI 4K 4000K, 70 CRI 5K 5000K, 67 CRI	N Narrow (Narrow 3x3) M Medium (Wide 3x3) RM Rectangular (5x5) W Wide (6x6)	BLANK 700mA	BZ Bronze BL Black WH White GR Gray PL Platinum CC Custom Color	PC Photo button Control (voltage specified and determined by voltage field) PR Twist lock photocontrol receptacle	F Fusing (voltage specified and determined by voltage field)

1 Specify voltage for PC and Fusing options  
2 DLC qualification 4K and 5K models only

**PERFORMANCE INFORMATION**

Series Number	Equivalency		Delivered Lumens	System Watts	Energy Savings	Max Candle Power	Beam Pattern	CCT	# Drivers/Current
	MH	HPS							
MHS-X-30LU-3K-N	250w	250w	4500	71	71%	34958	Narrow 3 X 3	3000K	1@700mA
MHS-X-30LU-3K-M	250w	250w	4632	71	71%	19018	Wide 3 X 3	3000K	1@700mA
MHS-X-30LU3K-RM	250w	250w	4079	71	71%	7146	Rectangular 5 X 5	3000K	1@700mA
MHS-X-30LU-3K-W	250w	250w	4468	71	71%	3755	6 X 6	3000K	1@700mA
MHS-X-30LU-4K-N	250w	250w	5530	71	71%	43674	Narrow 3 X 3	4000K	1@700mA
MHS-X-30LU-4K-M	250w	250w	5996	71	71%	23391	Wide 3 X 3	4000K	1@700mA
MHS-X-30LU-4K-RM	250w	250w	5163	71	71%	9514	Rectangular 5 X 5	4000K	1@700mA
MHS-X-30LU-4K-W	250w	250w	5792	71	71%	4538	6 X 6	4000K	1@700mA
MHS-X-30LU-5K-N	250w	250w	6045	71	77%	45341	Narrow 3 X 3	5000K	1@700mA
MHS-X-30LU-5K-M	250w	250w	6233	71	77%	24530	Wide 3 X 3	5000K	1@700mA
MHS-X-30LU-5K-RM	250w	250w	5575	71	77%	9246	Rectangular 5 X 5	5000K	1@700mA
MHS-X-30LU-5K-W	250w	250w	6164	71	77%	4559	6 X 6	5000K	1@700mA



# MLED

## Magnuliter LED Floodlights

LED FLOODLIGHTING



The MLED family is a large area LED floodlight designed to provide multiple NEMA distributions for best beam utilization for safety and security, build façade illumination, flag lighting, large sign or statuary accent.

Available in 80 LED floodlight that produces up to 11,500. Three NEMA beam spreads (3x3, 5x5, 7x7) allow the best utilization of the lumens and reduce spill light. The light engine is protected from the elements by the sealed tempered molded glass outer lens.

- LED drivers are universal 120-277V, 50/60Hz

- 80 LED floods 179w, 120-277V
- The lens door is sealed with four stainless steel screws and features a convex molded glass protective lens sealed with silicone gaskets
- A heavy gauge steel full yoke with aiming angle increments provided along with locking washers and stars for vibration resistance
- Listed to UL1598 for use in wet locations, IP65 rated; Some models meet DesignLights Consortium (DLC) qualifications, consult DLC website for more details: <http://www.designlights.org/QPL>

### MADE-TO-ORDER ORDERING INFORMATION – (BC PKG CODE)

<b>MLED</b>	-		<b>U</b>	-	<b>5K</b>	-		-	
<b>SERIES</b>		<b>NUMBER OF LEDs</b>	<b>VOLTAGE</b>		<b>CCT</b>	<b>BEAM SPREAD</b>	<b>FINISH</b>		<b>OPTIONS</b>
MLED Magnuliter LED Series		80L <sup>1</sup> 80 LEDs	U 120-277V 5 480V		5K 4800K nominal	W Wide 7x7 M Medium 5x5 N <sup>1</sup> Narrow 3x3	BZ Bronze BL Black GR Gray WH White		PRU Photocontrol receptacle 120-277V SP Surge protection

1 - MLED-80LU-5K-N model DLC qualified

### PERFORMANCE INFORMATION

Series Number	Equivalency		Delivered Lumens	System Watts	Lumens Per Watt	Max Candle Power	Beam Pattern	CCT	Drivers/Current
	MH	HPS							
<b>48% SAVINGS!</b> MLED-80LU-W	400w	400w	9,874	176	55	3,585	7 X 7	4800K	2@525mA
<b>48% SAVINGS!</b> MLED-80LU-M	400w	400w	11,226	178	62	17,648	5 X 5	4800K	2@525mA
<b>48% SAVINGS!</b> MLED-80LU-N	400w	400w	11,532	179	64	61,540	3 X 3	4800K	2@525mA

### STOCK ACCESSORIES/REPLACEMENT PARTS - (ORDER SEPARATELY)

Catalog Number	Description
4024C	2 3/8" O.D. slipfitter for yoke units – Bronze
4090	Heavy-duty cast iron crossarm fitting for horizontal trunnion; Bronze Lektrocote®

### DIMENSIONS

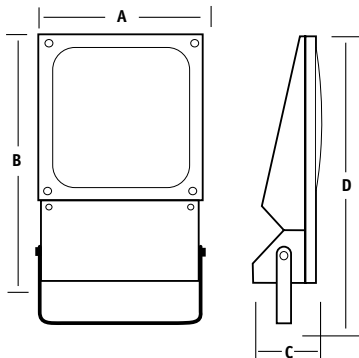

A	B	C	D	EPA	Weight
16"	18.8"	4.3"	21.0"	2.0 ft <sup>2</sup>	20 lbs.
406 mm	476 mm	108 mm	534 mm	0.06 m <sup>2</sup>	9.09 kg



## Architectural LED Floodlight/Wall Mount

- ALF is excellent for small floodlighting applications such as signs, façade, landscape accent or small area illumination
- The compact, low profile size allows the flood to be easily hidden or blend into the landscape environment
- Knuckle mount: Universal 1/2" swivel knuckle has serrated teeth for sure aiming
- Wall mount: Cast aluminum cover/quick mount plate and universal adapter allows easy installation to 3 1/2 or 4" standard junction boxes; Tilt for increased forward throw; up to 10ft mounting height
- Universal voltage driver is 120-277V, 50/60Hz, with 11 or 22 input watts
- Impact resistant tempered glass lens seals to housing with silicone gaskets
- Dark bronze durable powder paint finish
- Six or twelve 1.5w LEDs produce 510 or 1000 lumens at 5100K
- Wide 110 degree lateral spread covers three times the set back distance with uniform light
- Listed to UL1598 for use in wet locations  
AFL-6: IP65, ALF12: IP64



LED FLOODLIGHTING

### STOCK ORDERING INFORMATION

Catalog Number	Wattage	Number of LEDs	Voltage <sup>1</sup>	Delivered Lumens	Max Candle Power	CCT	Beam Pattern	# Drivers/Current	Weight lbs. (kg)	PKG. CODE
<b>1/2" Knuckle Mount</b>										
<b>ALF-6LU-5K-BZ</b>	<b>10.7w</b>	<b>6</b>	120-277V	510	628	5100K	6 X 5	1@470mA	4.0 (1.8)	FCC
<b>ALF-12LU-5K-BZ</b>	<b>21.5w</b>	<b>12</b>	120-277V	1000	1208	5100K	6 X 5	2@470mA	8.0 (3.6)	FCC
<b>Wall Mount</b>										
<b>ALFW-6LU-5K-BZ</b>	<b>10.7w</b>	<b>6</b>	120-277V	510	-	5100K	-	1@470mA	4.5 (2.0)	FCC
<b>ALFW-6LU-5K-BZ-PC</b>	<b>10.7w</b>	<b>6</b>	120V	510	-	5100K	-	1@470mA	4.5 (2.0)	FCC

<sup>1</sup> Unit should not be used above 240V in Canada

### EQUIVALENCY INFORMATION

Series Number	Equivalency			Energy Savings
	MH	HPS	CFL	
<b>ALF/ALFW-6L</b>	70w	70w	26w	85%
<b>ALF-12LU</b>	100w	100w	42w	80%

### DIMENSIONS

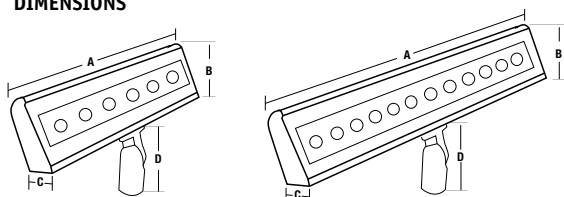

A	B	C	D
12/24"	3 1/2"	1 1/2"	3 1/2"
305/609.6 mm	89 mm	38 mm	89 mm

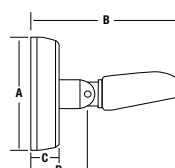

A	B	C	D
5 1/2"	6 1/2"	1 1/8"	2 1/8"
139 mm	165 mm	28 mm	54 mm



**HUBBELL**  
Outdoor Lighting

# Facade Flood

## Close Setback Floodlight

HID FLOODLIGHTING

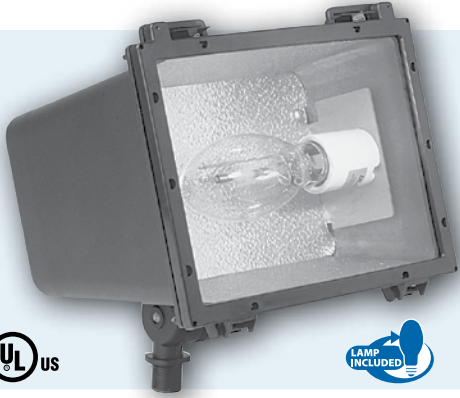

- Durable die-cast aluminum housing - has front gasket to seal to lens door
- Polycarbonate lens door retains tempered glass lens and provides tool-free entry
- Rugged 1/2" swivel knuckle for simple mounting to boxes or adapters (1/2-10NPSM)
- Wide, uniform beam spread designed for close set backs; Coverage is four times set back distance
- Ballastry -
  - HPS is reactor NPF 120V, -40°F starting
  - 50 PS is CWA HPF 120V, -20°F starting
  - 70-100 PSMH is CWA HPF 120-277V, -20°F starting, wired to 120V
  - 42 CFL is electronic 50/60 Hz 120-277V, 0°F starting
- Bronze powder coat protective finish
- Lamp included
- Listed to UL1598 for use in wet locations



### STOCK ORDERING INFORMATION

Catalog Number	Lamp Type/Wattage	NEMA Beam Type1 H° x V°	Voltage	Weight lbs. (kg)	EPA ft² (m²)	Ballast Type	PKG. CODE
<b>High Pressure Sodium</b>							
F-150S1	150	6(127°) x 7(146°)	120	8 (3.6)	.6 (0.1)	RX	FCC
<b>Pulse Start Metal Halide</b>							
F-050H1	50	6H x 7V	120	8 (3.6)	.6 (0.1)	CWA	FCC
F-070H1	70	6H x 7V	Quad-Tap®	9 (4.1)	.6 (0.1)	CWA	FCC
F-100H1	100	6(128°) x 7(146°)	Quad-Tap®	10 (4.5)	.6 (0.1)	CWA	FCC
<b>Compact Fluorescent</b>							
F-042F8†	42	6H x 7V	Quad-Tap®	5 (2.3)	.6 (0.1)	ELECTRONIC	FCC

Note: All HPS units are NPF; Pulse Start Metal Halide units are all HPF

Note: Medium base lamps included

† CFL lamp is 3500K

### STOCK ACCESSORIES<sup>1</sup> - (ORDER SEPARATELY, BC PKG CODE)

Catalog Number	Description
PBT-1	Photocontrol, button type, 120V
NMBC	Non-metallic, high-impact phenolic weatherproof box and cover; Box is drilled at 180° for two burial cable connectors which are included allowing feed-through capability; gasketed cover has weathertight 1/2" hub; Brass cover screws
S-302-M51	Pole-top slipfitter for 1/2" knuckle, slipfits 2 3/8" OD pipe, bronze finish
S-329-B	Cast round box with (4) 1/2" side hubs and (1) 1/2" back hub - cover included with 1/2" hub for fixture knuckle; natural aluminum finish
1031-3	Spike with splice box and 6 ft. cordset, portable; gray finish

1 - BC Pkg Code



S-302-M51



PBT-1

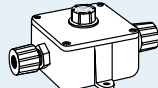

NMBC

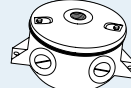

S-329-B

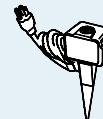

1031-3

### STOCK REPLACEMENT PARTS<sup>1</sup>

Catalog Number	Description
FL214-FRAMEGLASS	Lens door assembly
FL214-GASKET	Door gasket
FL214-KNUCKLE	Bronze 1/2" knuckle

1 - BC Pkg Code

### DIMENSIONS

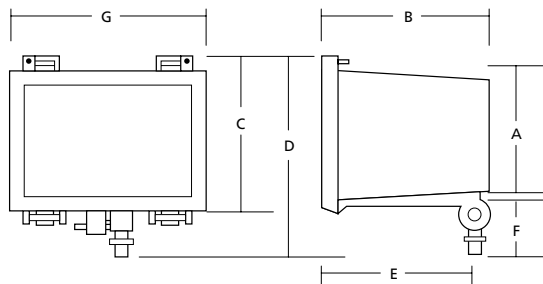

A	B	C	D	E	F	G
4 9/16"	6 7/8"	7 7/16"	8 1/16"	6 1/16"	2"	9"
116 mm	175 mm	189 mm	205 mm	154 mm	51 mm	229 mm



# Microliter® MIC

## Medium Beam Compact Floodlight

- Die-cast aluminum housing is light weight, yet rugged
- Cast door frame hinges and is removable for servicing, two screw closure
- Tempered, impact resistant glass lens, silicone gasket provides seal
- Large 1/2" universal aiming swivel knuckle (1/2 x 14 NPS)
- Rotatable optics for best beam utilization, medium base lamp included
- Medium and spot distributions available from 150w Pulse Start source; Standard medium distribution covers two times set back distance
- HPF Quad-Tap® and NPF 120V systems available, consult ordering information
- Bronze powder coat protective finish
- Lamp included
- Listed to UL1598 for use in wet locations



HID FLOODLIGHTING



### STOCK ORDERING INFORMATION

Catalog Number <sup>1</sup>	Wattage	Photometry NEMA/IES H° x V°	Lamp Type	Voltage	Weight lbs. (kg)	EPA ft² (m²)	Ballast Type <sup>2</sup>	PKG. CODE
<b>Normal Power Factor, High Pressure Sodium</b>								
MIC-0070S-651	70	5 (90°) x 6 (102°)	Coated	120 NPF	9 (4.1)	0.71 (0.1)	RX	BC
<b>High Power Factor, Pulse Start Metal Halide</b>								
MIC-0070H-358 <sup>3</sup>	70	5 (81°) x 4 (60°)	Clear	120/208/240/277	11 (5)	0.71 (0.1)	AL	BC
MIC-0100H-358 <sup>3</sup>	100	5 (86°) x 4 (62°)	Clear	120/208/240/277	13 (5.9)	0.71 (0.1)	AL	FCC
MIC-0150P-338 <sup>3</sup>	150	3 (32°) x 3 (36°)	Clear	120/208/240/277	14 (6.4)	0.71 (0.1)	PLA	FCC
MIC-0150P-358 <sup>3</sup>	150	6 (103°) x 5 (81°)	Clear	120/208/240/277	14 (6.4)	0.71 (0.1)	PLA	BC

### MADE-TO-ORDER ORDERING INFORMATION

Catalog Number <sup>1</sup>	Wattage	Photometry NEMA/IES H° x V°	Lamp Type	Voltage	Weight lbs. (kg)	EPA ft² (m²)	Ballast Type <sup>2</sup>	PKG. CODE
<b>Less Ballast - Medium Base Socket</b>								
MIC-XXXXX-XXX	Less Ballast	Varies	150 max	None	6 (2.7)	0.71 (0.1)	None	BC

- Lamp included
- Ballasts are Class H, -40°F starting (HPS), -20°F starting (PSMH)
- Quad-Tap® luminaires are shipped wired for 277V, easily changed to other voltages in the field

### STOCK ACCESSORIES<sup>1</sup> - (ORDER SEPARATELY, BC PKG CODE)

Catalog Number	Description
MIC-GS-2	Glare shield (360°) bronze
MIC-TB	Crossarm trunnion box, half yoke with large wiring box for mounting to any flat surface
MIC-SPC-2	Polycarbonate shield assembly
S-302-M51	Pole-top slipfitter for 1/2" knuckle, slipfits 2 3/8" OD pipe, bronze finish
PBT-1	Photocontrol, button type, 120V

### STOCK REPLACEMENT PARTS<sup>1</sup>

Catalog Number	Description
264-0292-9903	Lens
800-2827-0100	Bronze lens/door assembly
207-5011-0264	Bronze knuckle

1 - BC Pkg Code

1 - BC Pkg Code

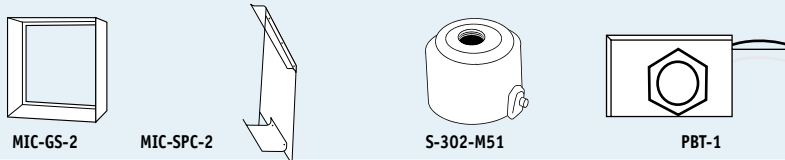

### DIMENSIONS

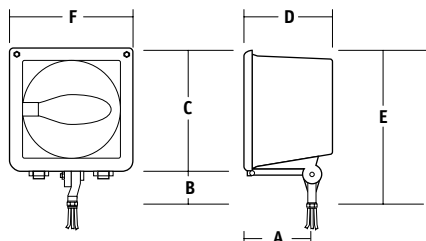

A	B	C	D	E	F
4 7/8"	2 1/2"	9 1/4"	7 3/8"	12 1/8"	9 1/4"
124 mm	64 mm	235 mm	187 mm	308 mm	235 mm

# Miniliter® V MHS

## Compact Wide Beam Floodlight

HID FLOODLIGHTING



- Sign, facade, area, accent and general security lighting
- Die-cast housing and door, rugged but lightweight
- Tempered glass lens
- Tool-free entry for lamping or maintenance, silicone gasket provides seal
- Steel yoke (MHS-Y) or cast aluminum 2 3/8" knuckle slipfitter (MHS-K) mounting
- Lamp included
- HPF ballastry in Quad-Tap®, and 480V (consult listings below)
- Wide, uniform beam for illumination of signs, facades and large areas; coverage is four times set back distance; lamp included
- UST fixtures are built in Christiansburg, VA and meet ARRA level 2 requirements
- Available in dark bronze powder paint finish
- Listed to UL1598 for use in wet locations, CSA 22.2 No. 250.0-00, suitable for wet locations
- U.S. Patent No. 6,461,026

MHS-Y (Yoke Mount)



STOCK ORDERING INFORMATION					STOCK ACCESSORIES - (ORDER SEPARATELY, BC PKG CODE)	
Catalog Number	Lamp Type/Wattage <sup>1</sup>	Voltage	Weight lbs. (kg)	PKG. CODE	Catalog Number	Description
<b>Pulse Start Metal Halide Yoke Mount</b>						
MHS-Y400P8	400W PS ED37	Quad-Tap® (120, 208, 240, 277V)	26 (11.8)	FCC	PBT-1	Photocontrol, button type, 120V
MHS-Y400P5	400W PS ED37	480V	26 (11.8)	BC	PBT-234	Photocontrol, button type, 208, 240, 277V
MHS-Y250P8	250W PS ED28	Quad-Tap® (120, 208, 240, 277V)	22 (10.0)	FCC	MHS4-SPC	Polycarbonate shield (for independent use only)
MHS-Y150P8	150W MH ED28	Quad-Tap® (120, 208, 240, 277V)	21 (9.5)	BC	MHS4-G	Wire guard, 2" square grid (for independent use only)
<b>Pulse Start Metal Halide Knuckle Mount</b>						
MHS-K400P8	400W PS ED37	Quad-Tap® (120, 208, 240, 277V)	31 (14.1)	BC	4024C	Steel slipfitter for 2" pipe, 2 3/8" OD yoke mount, bronze finish
MHS-K250P8	250W PS ED28	Quad-Tap® (120, 208, 240, 277V)	27 (12.2)	BC	MHS4-GS	Glare shield, black finish (for independent use only)
<b>High Pressure Sodium Yoke Mount</b>						
MHS-Y400S8	400W HPS E18	Quad-Tap® (120, 208, 240, 277V)	28 (12.7)	FCC	MHS4-VGS	Vertical glare shield, black finish (for independent use only)
MHS-Y400S5	400W HPS E18	480V	28 (12.7)	BC	MHS4-HGS	Horizontal glare shield, black finish (for independent use only)
MHS-Y250S8	250W HPS E18	Quad-Tap® (120, 208, 240, 277V)	24 (10.9)	BC	MHS-21	Two light bracket, bolt on yoke mount, slipfits 2 3/8" OD tenons, bronze finish
MHS-Y150S8	150W HPS ED28	Quad-Tap® (120, 208, 240, 277V)	23 (10.4)	BC	SSB-21-M51	Two light bracket, knuckle mount units, slipfits 2 3/8" OD tenons, bronze finish
					TWK-11	Steel wall bracket with 2 3/8" tenon, bronze finish (use with MHS-K)

<sup>1</sup> All fixtures have dark bronze powder finish and are shipped with mogul base lamp; NOTE: EPA is 1.4 sq. ft.

### MADE-TO-ORDER ORDERING INFORMATION - (BC PKG CODE)

SERIES	MOUNTING	WATTAGE/SOURCE	VOLTS	FINISH	UST	OPTIONS
MHS Miniliter V Series	Y Yoke K Knuckle	<b>PULSE START METAL HALIDE</b> 150P 150w PSMH 250P 250w PSMH 320P 320w PSMH 400P 400w PSMH <b>HIGH PRESSURE SODIUM</b> 150S 150w HPS 250S 250w HPS 400S 400w HPS	5 480V 6 347V 8 Quad Tap® (120, 208, 240, 277V)	BZ Bronze BL Black WH White GR Gray PS Platinum CC Custom Color	UST U.S. transformed, ARRA level 2	QST Quartz standby Skt/Relay EM Quartz Skt C3 3ft. 16/3 SO C6 3ft. 16/3 SO PR(X) NEMA Photo cell receptacle (replace X with voltage: 1=120V, 2=208V, 3=240V, 4=277V, 5=480V, 6=347V) F(X) Fusing (replace X with voltage: 1-120V, 2-208V, 3-240V, 4-277V, 5-480V, 6-347V)

### DIMENSIONS

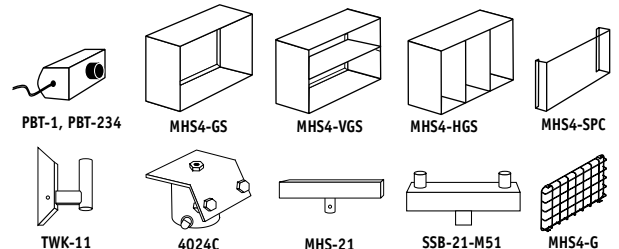
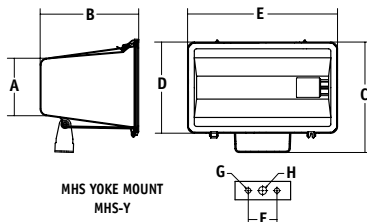
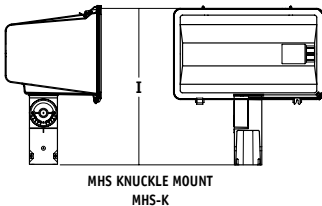

A	B	C	D	E	F	G	H	I
6 1/2"	14 1/2"	12"	9 7/8"	16 1/4"	3 1/8"	17/32"	7/8"	17"
165 mm	368 mm	305 mm	251 mm	413 mm	79 mm	14 mm	22 mm	432 mm





- MV series features vertical lamp, wide uniform beam distribution (coverage is 4x set back distance)
- MH series features horizontal lamp, medium or narrow distribution (medium distribution is 2x set back distance)
- Twin closure screws are steel with protective HubbellGard® coating; Allow easy service and long-life
- Die-cast aluminum housing and door provide protection for internal components
- Tempered, clear glass lens, sealed with silicone door gasket
- PowrPan® ballast tray allows easy access and ground maintenance of electrical package up to 400w
- Quad Tap® ballast standard; Change 8 to 5 for 480V, to 6 for Tri-Tap 120/277/347V, to E for 50Hz, 220/240V
- Standard dark bronze finish; Add M50 for black, M53 for gray
- Listed to UL1598 for use in wet locations
- High ambient versions available – consult factory



### STOCK ORDERING INFORMATION

Catalog Number MVM <sup>3</sup> Trunnion Mount	Catalog Number MVK <sup>1,3</sup> Slipfitter Mount	Photometry NEMA/IES H° x V°	Source/ Wattage	Weight lbs. (kg)	EPA ft <sup>2</sup> m <sup>2</sup>	PKG. CODE
MVM-1000H-268 <sup>2</sup>	MVK-1000H-268 <sup>2</sup>	6(130°) x 6(114°)	1000w PSMH	44 (21.0)	2.3 .22	BC
MVM-1000H-265 <sup>2</sup>	–	6(130°) x 6(114°)	1000w PSMH	44 (21.0)	2.3 .22	BC

### ORDERING INFORMATION



**10-Day Quick Ship Ordering Guide**  
Order Limit Per Fixture Selection: 15 – BC Pkg Code

Catalog Number Trunnion Mount	Photometry NEMA/IES H° x V°	Source/ Wattage	Weight lbs. (kg)	EPA ft <sup>2</sup> m <sup>2</sup>	PKG. CODE
MVM-0400P-268	7(146°) x 6(119°)	400w PSMH	41 (18.6)	2.3 .22	BC
MVM-0400P-268-LP (Lamp included)	7(146°) x 6(119°)	400w PSMH	41 (18.6)	2.3 .22	BC

### MADE-TO-ORDER ORDERING INFORMATION

Catalog Number MVM <sup>3</sup> Trunnion Mount	Catalog Number MVK <sup>1,3</sup> Slipfitter Mount	Photometry NEMA/IES H° x V°	Source/ Wattage	Weight lbs. (kg)	EPA ft <sup>2</sup> m <sup>2</sup>	PKG. CODE
MVM-HPS-SEA2 <sup>1</sup>	–	7(146°) x 6(115°)	less ballast	19 (8.6)	2.3 .22	BC
MVM-0250P-268 <sup>4</sup>	MVK-0250P-268 <sup>4</sup>	7(146°) x 6(115°)	250w PSMH	36 (16.3)	2.3 .22	BC
–	MVK-0400P-268 <sup>4</sup>	7(146°) x 6(119°)	400w PSMH	41 (18.6)	2.3 .22	BC
MVM-0250S-268	MVK-0250S-268	7(144°) x 6(113°)	250w HPS	36 (17.3)	2.3 .22	BC
MVM-0400S-268	MVK-0400S-268	7(144°) x 6(113°)	400w HPS	43 (19.5)	2.3 .22	BC
MHP-0400P-338	MHK-0400P-338	3(44°) x 3(37°)	400w PSMH	32 (14.5)	2.3 .22	BC
MHP-0400P-368	MHK-0400P-368	5(83°) x 5(85°)	400w PSMH	32 (14.5)	2.3 .22	BC
MHP-0400S-238	MHK-0400S-238	5(73°) x 3(32°)	400 HPS	43 (19.5)	2.3 .22	BC
MHP-0400S-268	MHK-0400S-268	7(144°) x 6(113°)	400 HPS	43 (19.5)	2.3 .22	BC

- 1 For use with remote ballasts, maximum wattage: 400; MHK slipfits 23/8" O.D
- 2 3 ft. of 16/3 S.O. cord (cord on MVM style only) included; Dark bronze finish is standard
- 3 Dark bronze finish is standard
- 4 ED28 lamp size is required; For lamp shipped in fixture carton add - LP

NOTE: Lamps are not included; All ballasts are HPF and Quad-Tap® 120/208/240/277V; For 480V, change last digit 8 to 5; For Tri-Tap® 120/277/347V, change last digit 8 to 6; For 220/240V, 50 Hz, consult factory; Order mounting accessories separately

### MADE-TO-ORDER REPLACEMENT PART

Catalog Number	Description	PKG. CODE
800-2918-0115	Lens door assembly, bronze	BC

# MV/MH

## Magnuliter®

### MADE-TO-ORDER ORDERING INFORMATION - OPTIONS

OPTIONS - Add Suffix

Catalog Number	Description
-F(X)	Single fuse for 120/277/347V; Double fuse for 208/240/480V; (specify voltage, e.g. "F(240)")
-PCR(X)	Twist-Lock™ photocontrol receptacle, specify voltage (e.g. "PCR(120)") when ordering with Quad-Tap or Tri-Tap (PTL photocontrol or WIH-OM ordered separately)
-C(X <sub>1</sub> )(X <sub>2</sub> )	16/3 pre-wired S.O. Cord - replace X <sub>1</sub> with cord length desired: 3 - 3ft.; 6 - 6ft.; 12 -12ft.; specify voltage by replacing X <sub>2</sub> (e.g. "C6(120)"); not available in knuckle style mounting
-L	Unit with lamp (shipped separately)
-LP	Unit with lamp (shipped in fixture carton)
-M53	Gray Lektrocote® finish
-M50	Black Lektrocote® finish

### STOCK ACCESSORIES - (ORDER SEPARATELY)

Catalog Number	Description
MVM-V2 <sup>1</sup>	Top visor
MVM-S2 <sup>1, 2</sup>	Polycarbonate shield
MVM-PCR	Photocontrol receptacle (120-480V) less photocontrol
4024C	Steel slipfitter for MVM, mounts over 2 3/8" OD tenons
PBT-1	Button photocontrol 120 volt (knockout on back & door)
PBT-234	Button photocontrol 208, 240, 277 volt
4040	Steel angle bracket for MVM, bronze finish
4041	Steel angle bracket with 2 3/8" OD tenon for MVK, bronze finish
TWK-11	Steel wall bracket with 2 3/8" tenon, bronze finish (use with MVK/MHK)
WIH-OM-UNV	120/277/347VAC Wireless On/Off control, see PSG8 pg. 382
WIH-OM-480	480VAC Wireless On/Off control, see PSG8

- 1 Visor and polycarbonate shield may be used together; Visors are finished in bronze Lektrocote®  
 2 For use with 400w and below

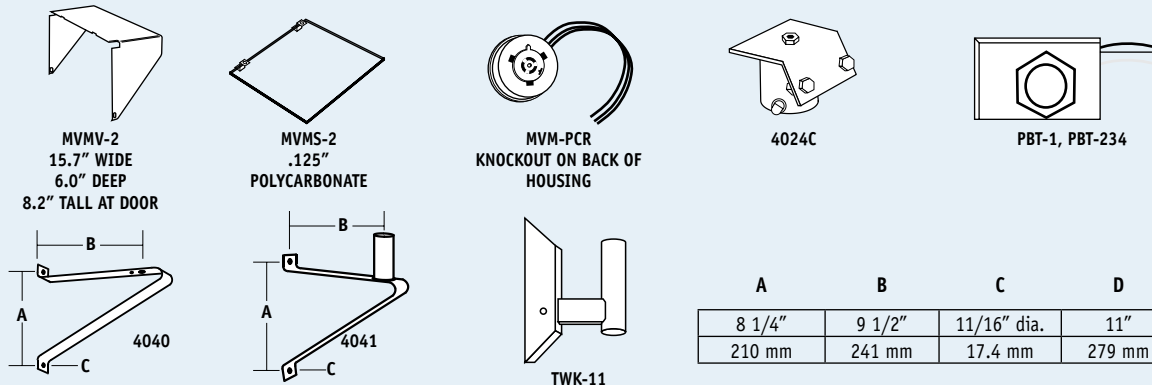

A	B	C	D	E	F
8 1/4"	9 1/2"	11/16" dia.	11"	8"	8"
210 mm	241 mm	17.4 mm	279 mm	203 mm	203 mm

### DIMENSIONS

	A	B	C	D	E	F	G	H	I	J
MVM/MHP	3 1/8"	16 3/8"	25 1/2"	9"	17 7/8"	17/32"	7/8"	1 9/16"	12" R.	8 5/8" R.
	79 mm	416 mm	648 mm	229 mm	454 mm	14 mm	22 mm	40 mm	305 mm	219 mm
MVK/MHK	5 1/2"	16 3/8"	25 1/2"	9"	17 7/8"	-	-	-	-	-
	140 mm	416 mm	648 mm	229 mm	454 mm	-	-	-	-	-

## Quartzliter® Series – Industrial Grade

- Die-cast aluminum housing and door, deep fin system maintains rated lamp life
- High temperature lens, silicone gasket, tool-free stainless latch entry
- Large 1/2" swivel knuckle provides versatile aiming
- QL produces a wide uniform beam with true color rendering
- QL505 suitable for 300-500w lamps, QL1505 suitable for 900-1500w lamps
- Models available with or without lamp, consult listings
- Gray and dark bronze finishes are available, consult listings
- Listed to UL1598 for use in wet locations



HID FLOODLIGHTING



### STOCK ORDERING INFORMATION

Catalog Number	Max. Watts	Housing Finish	NEMA Beam Spread H° x V°	Weight lbs. (kg)	EPA ft² (m²)	PKG. CODE
<b>Lamp Not Included</b>						
QL-1505 <sup>1</sup>	1000/1500	Gray	6(115°) x 5(78°)	6 (2.7)	.9 (0.1)	BC
QL-505	300/500	Gray	5(88°) x 5(82°)	4 (1.8)	.5 (0.1)	BC
QL-505-BZ	300/500	Bronze	5(88°) x 5(82°)	4 (1.8)	.5 (0.1)	BC

- 1 Do not aim at ±10° from horizontal or higher  
 2 Fixture voltage is controlled by lamp voltage rating  
 Note: Do not operate on voltage higher than lamp voltage rating, shortens lamp life and increases heat stress within the fixture

### STOCK REPLACEMENT PARTS

Catalog Number	Description
26401849803	Glass lens QL505
26401839805	Glass lens QL1505
20750110214	Knuckle, gray
80021660108	Replacement socket QL505
705327	Replacement socket QL1505

### STOCK ACCESSORIES (ORDER SEPARATELY)

Catalog Number	Description	Weight lbs. (kg)
<b>QL-505 Series</b>		
QL-5G	Wire guard (2 inch square grid)	1 (0.5)
QL-VS	Top/side visor (max use two - at 180°)	.5 (0.2)
26100119905	500w 120V Quartz lamp	-
<b>QL-1505 Series</b>		
QL-15G	Wire guard (2 inch square grid)	1.3 (0.6)
QL-15V	Top visor / bottom visor	1.3 (0.6)
QL-VS	Side visor (will not work with QL-15V on same fixture)	.5 (0.2)
26100149902	1500w 240V Quartz lamp	-
<b>QL-500 / QL-1500</b>		
QL-TB	Crossarm trunnion box; Half yoke with large wiring box for mounting to any flat surface, natural aluminum	.8 (0.4)
S-302	Pole top slipfitter for 1/2" swivel knuckle; slipfits 2 3/8" OD pipe; gray finish	.8 (0.4)
S-302-M51	Pole-top slipfitter for 1/2" knuckle, slipfits 2 3/8" OD pipe; bronze finish	.8 (0.4)

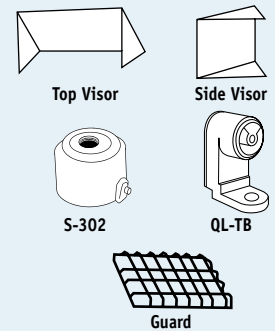

### DIMENSIONS

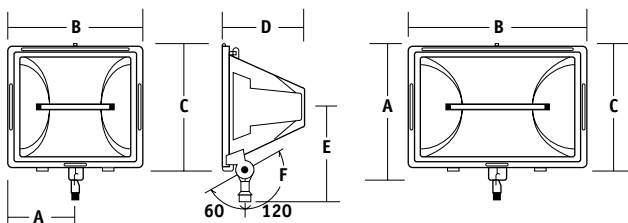

	A	B	C	D	E	F
QL-505	4 5/16"	8 5/8"	8 1/2"	5 1/4"	7"	2 1/2"
	110 mm	219 mm	216 mm	133 mm	178 mm	64 mm
QL-1505	4 1/2"	14"	8 1/2"	5 1/4"	7"	2 1/2"
	292 mm	356 mm	216 mm	133 mm	178 mm	64 mm

# Q Series

## Quartz Floods – Commercial Grade

HID FLOODLIGHTING

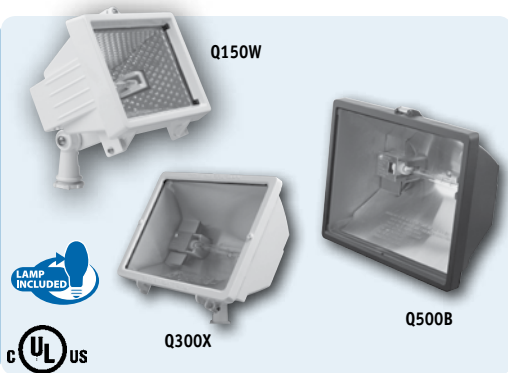

- General and accent flood lighting where short burning hours are planned
- Instant on/off
- 150 to 500w capability
- Die-cast aluminum construction for long life
- Single screw door closure for easy installation
- Tempered glass lens protects lamp
- 1/2" Cast swivel knuckle fits standard boxes and covers
- Wide, uniform beam for even illumination
- 120V lamps are included
- Units offered in dark bronze or white powder paint finish
- Listed to UL1598 for use in wet locations

### STOCK

### ORDERING INFORMATION

Catalog Number	Wattage/Voltage	Color	Photometry NEMA/IES H° x V°	Weight lbs. (kg)	EPA ft <sup>2</sup> (m <sup>2</sup> )	PKG. CODE
Lamp Included						
Q-150-B	150w/120V	Bronze	6(124°) x 6(124°)	1.4 (0.6)	.14 (.01)	FCC
Q-150-W	150w/120V	White	6(124°) x 6(124°)	1.4 (0.6)	.14 (.01)	FCC
Q-300-B	300w/120V	Bronze	6(109°) x 4(66°)	2.6 (1.2)	.6 (.05)	FCC
Q-300-W	300w/120V	White	6(109°) x 4(66°)	2.6 (1.2)	.6 (.05)	BC
Q-500-B	500w/120V	Bronze	6(100°) x 5(86°)	2.6 (1.2)	.6 (.05)	FCC
Q-500-W	500w/120V	White	6(100°) x 5(86°)	2.6 (1.2)	.6 (.05)	FCC

### DIMENSIONS

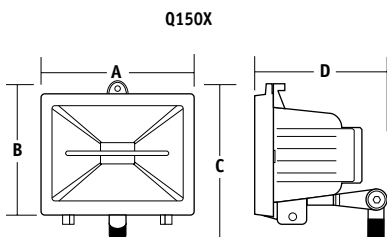

### Q500X/Q300X

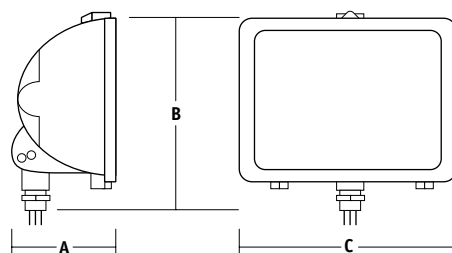

	A	B	C	D
Q150X	5 7/16"	3 7/8"	5 1/2"	4"
	138 mm	98 mm	139 mm	100 mm
Q500X/ Q300X	3 5/8"	7 23/32"	8 13/16"	
	92 mm	196 mm	227 mm	



# QWL Series

## Portable Quartz Work Lights

Versatile task lighting fixtures, five-foot cord set, weather-tight switch, 120V, protective guard, adjustable aiming. Lamps included. UL listed. QWL-1000T features adjustable tripod unit with handy removable top for maximum versatility. Twin 500w units with guards and individual switching. Tripod and fixtures are safety yellow finish with black accents.

- Three popular styles with five foot cord sets and weathertight switch
- Die-cast aluminum housing and door for light weight
- Adjustable fixture aiming after mounting

- Protective wire guards included
- Designed for standard 120V house current
- Mini-stand unit shipped with both 300 and 500w lamps for brightness choice and twice the life
- Tripod "2 in 1" unit adjusts from 33" to 69" height, twin 500w dual lamp upper assembly easily removes for table top or floor mount versatility
- Rigid steel tubing with tool-free nylon twist clamps
- Listed to UL1598 for use in wet locations



HID FLOODLIGHTING



### STOCK

### ORDERING INFORMATION

Catalog Number	Wattage/Voltage	Mounting	Weight lbs. (kg)	PKG. CODE
QWL-150C	150w/120V	Clamp/hook	2.0 (.91)	FCC
QWL-500S	500w/120V & 300w/120V	Mini-stand	4.0 (1.8)	FCC
QWL-1000T	2x500w/120V	Tripod	27.0 (12.3)	FCC

Note Lamp(s) included (T3-RSC)

### DIMENSIONS

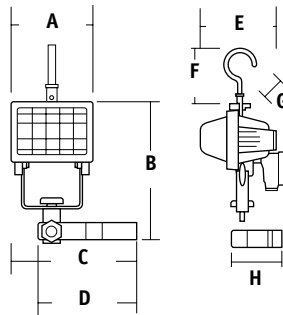

	A	B	C	D	E	F	G	H
QWL-150C	5"	12 1/4"	7 5/8"	6"	5.5"	3.5"	1.25"	3 7/8"
	127 mm	311 mm	194 mm	152 mm	140 mm	89 mm	32 mm	98 mm

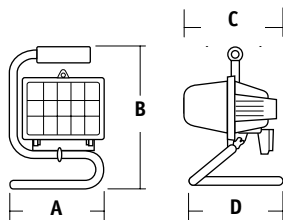

	A	B	C	D
QWL-500S	8"	12 1/4"	8 5/8"	8"
	203 mm	311 mm	219 mm	203 mm

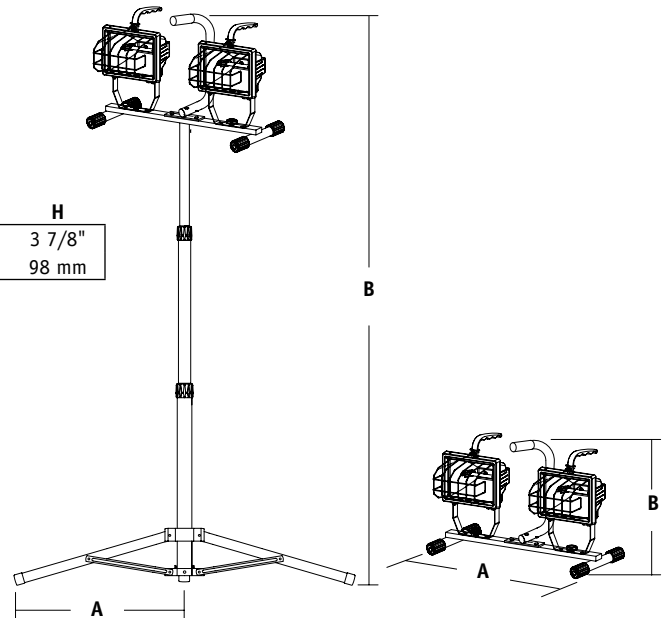

	A	B	A	B
Base	31"	69"		
QWL-1000T	203 mm	1752 mm		
Fixture	19"	14"		
QWL-1000T	483 mm	356 mm		



**HUBBELL**  
Outdoor Lighting



# R2LHQ

## Decorative Twin-Head Quartz Halogen Motion Sensor Kit

FLOODS/MOTION SENSORS



Attractive security floodlight set. Powerful 75w G8 quartz floods controlled by 130° motion sensor so you save energy – lights only when you need it!

- Die-cast aluminum decorative heads
- Thumb screw adjustment for aiming – no tools required
- Cast aluminum cover plate – use on 4" junction boxes (not included)

- Weathertight 130° motion sensor with multiple controls
- Lamps included
- White or bronze
- Listed to UL1598 for use in wet locations



### STOCK ORDERING INFORMATION

Catalog Number	Watts	Finish	Beam	Weight lbs. (kg)	PKG. CODE
R2LHQ	2x75	Bronze	Wide	1.5 (.23)	FCC
R2LHQW	2x75	White	Wide	1.5 (.23)	FCC

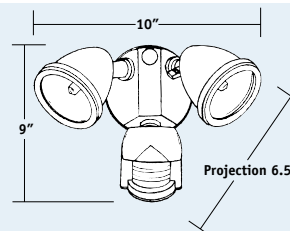

# S/M Series



#### S Series Motion Sensors

- 270° detection field
- Surge protection; 600V, 1200A, 30 Joules
- Center focus range to 75 feet
- Broad 20-25 ft. detection range
- 1500w incandescent load capacity
- 120V, 60Hz
- Time-on adjustment; Manual override
- LED unit on indicator
- Test mode
- Sensitivity adjustment
- UL 1598 listed for use in wet locations

#### S Series Sensor Kits

- Sensor above plus (2) 150w PAR cast aluminum lampholders and 4" round cover plate
- Complete instructions for operation
- UL/C-UL wet location listed with lampholders aimed below horizontal

#### M Series Motion Sensors

- 130° detection field
- Surge protection; 600V, 1200A, 14 Joules
- Center focus range to 40 feet
- Broad 20 ft. detection range
- 500w incandescent load capacity
- 120V, 60Hz
- Time on adjustment
- Sensitivity adjustment
- Night/daytime or night operation mode
- UL 1598 listed for use in wet locations

#### M Series Sensor Kits

- White finish
- Sensor above plus (2) 150w PAR non-metallic lampholders and 4" round non-metallic cover plate
- Complete instructions for operation
- UL/C-UL wet location listed with lampholders aimed below horizontal

### STOCK ORDERING INFORMATION

Catalog Number	Description	Weight lbs. (kg)	PKG. CODE
S0-W	Sensor only, 270° detection range, white	0.7 (.32)	FCC
S2LH-W	Sensor kit, twin 150w lampholders, cover plate, white	1.7 (.77)	FCC
M0-W	Sensor only, 130° detection range, white	0.5 (.23)	FCC
M2LH	Sensor kit, 130° detection range, twin lampholders, cover plate, bronze	1.2 (.54)	FCC

#### DIMENSIONS

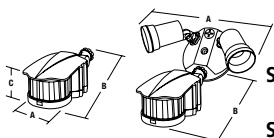

	A	B	C
S0	3 1/2"	8"	2 5/8"
S2	89 mm	203 mm	67 mm
M0	10 1/2"	8 1/2"	
M2	267 mm	216 mm	

	A	B	C
M0	2 3/8"	6"	2 1/4"
M2	60 mm	152 mm	57 mm
	10 1/2"	6"	
	267 mm	152 mm	



# Mounting Accessories

## Accessories: Trunnion Mount Fittings

**STOCK** ORDERING INFORMATION

Catalog Number	Description	Weight lbs. (kg)
<b>HID Floodlights</b>		
4024C	Steel slipfitter for 2" pipe, 2 3/8" OD yoke mount, bronze finish; Also available in gray: <b>4024CM53</b> and galvanized: <b>4024CM38</b>	4 (1.8)
4090	Heavy-duty cast iron crossarm fitting for horizontal trunnion; Bronze Lektrocote®	3 (1.4)
LR-30 <sup>1</sup>	Safety retainer complete with crimp clamp and 30" long 1/8" stranded metal cable	.3 (0.1)

1 For yoke (trunnion) mounted units only

**DIMENSIONS**

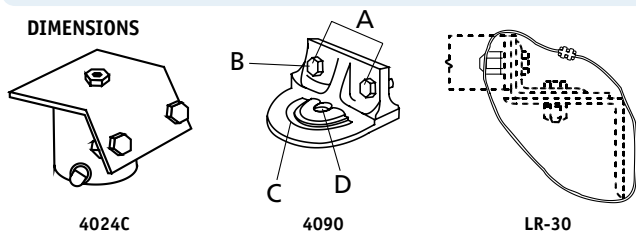

	A	B	C	D
4090	3 1/8" 79 mm	9/16" dia. 14 mm	5/16" slot 8 mm	13/16" dia. 21 mm

## Accessories: Wall and Pole Mount Brackets

**STOCK** ORDERING INFORMATION

Catalog Number <sup>1</sup>	Description	Weight lbs. (kg)	Maximum Loading Weight
<b>For Use With Crossarm Fittings</b>			
4040	Heavy-duty steel wall/pole bracket; bronze Lektrocote®	5.5 (2.5)	90 (40.8)
<b>For Use With Slipfitter Fittings</b>			
4041	Heavy-duty steel wall/pole bracket 2" pipe (2 3/8" OD) tenon fitting for use with slipfitter units or 4024C; bronze Lektrocote®	7 (3.2)	90 (40.8)
241-C-XX	Flat surface bracket - 90° horn steel (2 3/8" OD)	16 (7.3)	70 (30.7)
TWK-11	Wall bracket with splice compartment for thru-wiring with 2" pipe (2 3/8" OD) tenon	15 (6.8)	90 (40.8)
TCB-1	Wood pole clamp on bracket with 2" pipe (2 3/8" OD) tenon; Clamps 6" to 12" diameter	16 (7.3)	70 (31.7)
TCB-2	Wood pole clamp on bracket with 2" pipe (2 3/8" OD) tenon; Two tenons at 120° (clamps 6" to 12" diameter)	20 (9.1)	140 (63.4)
TCB-3	Wood pole clamp on bracket with 2" pipe (2 3/8" OD) tenon; Three tenons at 120° (clamps 6" to 12" diameter)	28 (12.7)	210 (95.1)
<b>Tenon Reducers</b>			
TPR-2 <sup>2</sup>	2 1/2" to 2" pipe size tenon reducer	6 (2.7)	105 (47.6)
TPR-3 <sup>3</sup>	3" to 2" pipe size tenon reducer	8 (3.6)	105 (47.6)
TPR-4 <sup>4</sup>	4" to 2" pipe size tenon reducer	9 (4.1)	105 (47.6)

1 Bronze color standard, for other colors add suffix to catalog number: -M50 black finish, -M52 white finish, -M53 gray finish.

2 Bracket I.D., 3 1/16"

3 Bracket I.D., 3 1/2"

4 Bracket I.D., 4 5/8"

**DIMENSIONS**

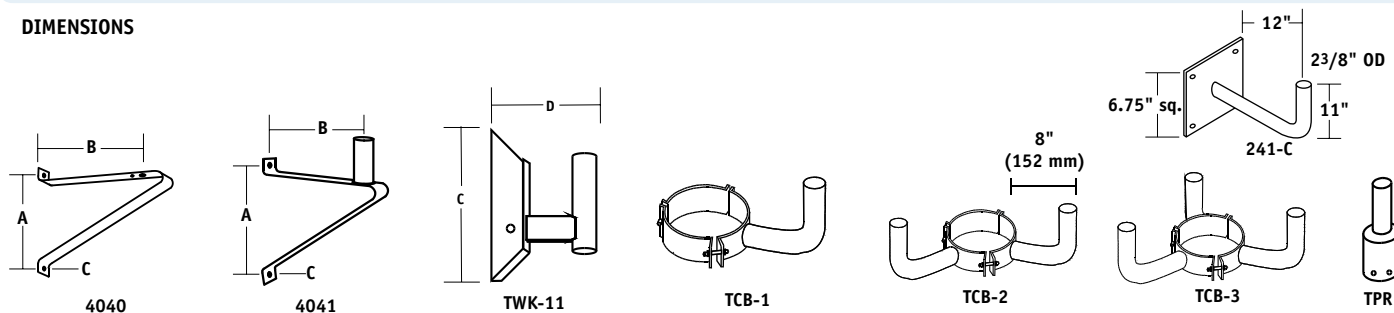

	A	B	C	D	E
4040/4041	8 1/4" 210 mm	9 1/2" 241 mm	11" 279 mm	8" 203 mm	11/16" dia. 17 mm



# Mounting Accessories

## Accessories: Steel Bullhorns

Steel "bull horn" floodlight brackets. Fixture mounting pipe or tenons are 2<sup>3</sup>/<sub>8</sub>" O.D. and brackets mount on 2<sup>3</sup>/<sub>8</sub>" O.D. pole tenons. Stainless steel set screws and thru-bolts included. Finishes as shown below.

### MADE-TO-ORDER ORDERING INFORMATION

Catalog Number	Maximum Loading		Description	Finish	Weight lbs. (kg)	EPA ft <sup>2</sup> (m <sup>2</sup> )	PKG. CODE
	Fixture Qty.	Weight lbs (kg)					
THB-21	2	210 (95.3)	Two tenons at 180°	Bronze	17 (7.7)	.9 (0.1)	PW
THB-21-M53	2	210 (95.3)	Two tenons at 180°	Gray	17 (7.7)	.9 (0.1)	PW
THB-31	3	315 (142.9)	Three tenons at 180°	Bronze	30 (13.6)	1.5 (0.1)	PW
THB-32	3	315 (142.9)	Three tenons at 120°	Bronze	23 (10.4)	1.2 (0.1)	PW
THB-41	4	420 (190.5)	Four tenons at 180°	Bronze	43 (19.5)	2.2 (0.2)	PW
THB-43	4	420 (190.5)	Four tenons at 90°	Bronze	29 (13.1)	1.3 (0.1)	PW

### DIMENSIONS

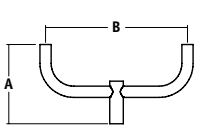

THB-21

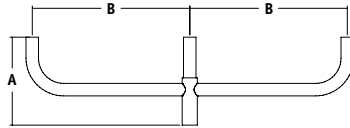

THB-31

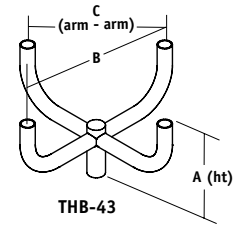

THB-43

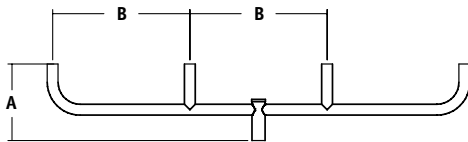

THB-41

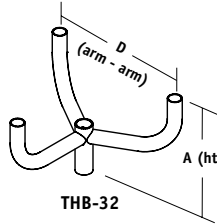

THB-32

A	B	C	D
17"	30"	21.25"	26"
431 mm	762 mm	539 mm	660 mm

## Accessories: Square Steel Brackets (Project finishes available)

Decorative steel floodlight brackets. 4" square tubing with 2<sup>3</sup>/<sub>8</sub>" O.D. fixture tenons. Square 4" bottom with 2<sup>1</sup>/<sub>2</sub>" I.D. internal adapter for standard round tenons. Available in multiple finishes as shown. Use with SSS series poles.

### MADE-TO-ORDER ORDERING INFORMATION

Catalog Number	Description	Maximum Weight Per Tenon		EPA		Weight		PKG. CODE
		lbs.	(kg)	ft <sup>2</sup>	(m <sup>2</sup> )	lbs.	(kg)	
SSB-21-M51	Twin 180°	60	(27.2)	1.2	(0.1)	24	(10.9)	PW
SSB-31-M51	Triple 180°	60	(27.2)	2.3	(0.2)	44	(19.9)	PW
SSB-41-M51	Quad 180°	60	(27.2)	3.4	(0.3)	64	(29)	PW
SSB-43-M51	Quad 90°	60	(27.2)	2.8	(0.3)	46	(20.8)	PW

Note: Bronze color standard, for others, add suffix to catalog number: -M50; Black finish; M52; White finish; M53; Gray finish.

### DIMENSIONS

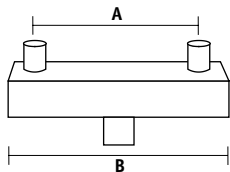

SSB-21

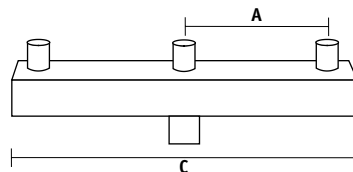

SSB-31

A	B	C	D	E
24"	30"	54"	78"	30"
610 mm	762 mm	1372 mm	1981 mm	762 mm

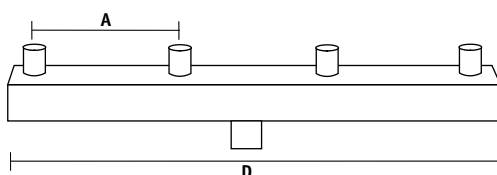

SSB-41

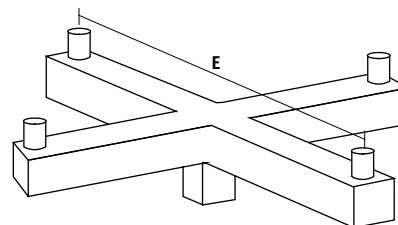

SSB-43





# Photocontrols



## STOCK ORDERING INFORMATION

Catalog Number	Voltage	Max. Watts Incand.	Max. Watts HID		Weight lbs. (kg)	PKG. CODE
			HPF	NPF		
<b>Photocontrol - Button Type<sup>1</sup></b>						
	PBT-1 <sup>6</sup>	120	1200	400	250	.125 (0.1) SCC
	PBT-234 <sup>6</sup>	208/240/277	1200	400	250	.125 (0.1) SCC

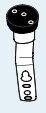
## MADE-TO-ORDER ORDERING INFORMATION

Catalog Number	Voltage	Max. Watts Incand.	Max. Watts HID		Weight lbs. (kg)	PKG. CODE
			HPF	NPF		
<b>Photocontrol - 1/2" Thread Mount<sup>2</sup></b>						
	PTA-1 <sup>6</sup>	120	2000	1000	400	.25 (0.1) SCC
	PTA-8 <sup>6</sup>	120-277	2000	1000	400	.25 (0.1) SCC
	PTA-5 <sup>6</sup>	480	2000	1000	400	.25 (0.1) SCC
<b>Photocontrol - Twist-Lock<sup>®</sup> Cell<sup>3</sup></b>						
	PTL-1 <sup>6</sup>	120	1800	1000	400	.25 (0.1) SCC
	PTL-8 <sup>6</sup>	120-277	1800	1000	400	.25 (0.1) SCC
	PTL-5	480	1800	1000	400	.25 (0.1) SCC
	PTL-6 <sup>6</sup>	347	1800	1000	400	.25 (0.1) SCC
<b>Receptacle - Remote Twist-Lock<sup>®</sup> Cell with Bracket<sup>4</sup></b>						
	PRR	120-480	1800	1000	400	.5 (0.2) SCC
<b>Shorting Cap - Twist-Lock<sup>®</sup> Mount<sup>5</sup></b>						
	PSC	Completes circuit - Eliminates PCR				.25 (0.1) SCC

- 1 Miniature photocontrol sealed in a sturdy plastic housing 2 1/16" x 1 1/8" x 7/8" with 3/4" nipple length, nipple dia. is 3/8" pipe thread - 5/8" outside diameter fits 1/2" tapped hubs; Use in any suitable enclosed box or luminaire; A gasket and lock nut provide weather tight seal at exit point
- 2 Weatherproof photocontrol in a polycarbonate housing with field adjustable light sensitivity level feature; 3 5/8" x 2" x 1 1/2" housing with 5/8" nipple length
- 3 Weatherproof Twist-Lock<sup>®</sup> photocell enclosed in a high butyrate protective housing; Meets EMI-NEMA standards; For use with Twist-Lock<sup>®</sup> receptacles (PCR)
- 4 Remote receptacle for PTL Twist-Lock<sup>®</sup> cell; Includes aluminum angle bracket and color coded leads; Bolts to wood poles, crossarms, walls or any flat surface
- 5 Weatherproof shorting cap to complete circuit and allow fixture to operate when Twist-Lock<sup>®</sup> photocontrol (PTL) is not used; For use with Twist-Lock<sup>®</sup> receptacles (PCR)
- 6 CSA certified

# LNC

## Ultra Compact LED Wallpack – Zero Uplight

LED WALLPACKS



The compact LED LNC is designed for entry/perimeter illumination, available in 3 lumen packages for safety, security and general illumination applications; Neighbor friendly with zero uplight; Typical mounting height up to 12 feet with 40ft fixture spacing (without acrylic diffuser) and 30ft spacing with acrylic diffuser installed. Photocontrol option

• IES Progress Award Winner - 2012

• DesignLights Consortium (DLC) qualified 5/7/9 LED models 4K and 5K only, consult DLC web site for more details:  
<http://www.designlights.org/QPL>

### APPLICATIONS

Zero uplight; IDA compliant; Listed to UL1598 for use in wet locations; Long-life (60,000hr L96 rated) high output LEDs; Quick mount adapter; Designed for both recessed box or surface conduit wiring; CCT/CRI and more options available in the larger 7L and 9L lumen packages.

### STOCK ORDERING INFORMATION

Catalog Number	System watts	delivered lumens	Voltage	CCT	# Drivers/ current	Mounting Height	Weight lbs. (kg)	PKG. CODE
LNC-5LU-5K	12.8w	967	120-277V	5000K	1@700mA	up to 10 ft.	4.0 (1.8)	FCC
LNC-5LU-5K-PC	12.8w	967	120V	5000K	1@700mA	up to 10 ft.	4.0 (1.8)	FCC
LNC-7LU-5K	16.4w	1147	120-277V	5000K	1@700mA	up to 11 ft.	4.0 (1.8)	FCC
LNC-9LU-5K	20.6w	1460	120-277V	5000K	1@700mA	10-12 ft.	4.0 (1.8)	FCC



### 5-Day Quick Ship Ordering Guide Order Limit Per Fixture Selection: 15 – BC Pkg Code

Catalog Number	System watts	delivered lumens	Voltage	CCT	# Drivers/ current	Mounting Height	Weight lbs. (kg)	PKG. CODE
LNC-7LU-5K-3-1-PC1	16.4w	1147	120-277V	5000K	1@700mA	up to 11 ft.	4.0 (1.8)	FCC
LNC-9LU-5K-3-1-PC1	20.6w	1460	120-277V	5000K	1@700mA	10-12 ft.	4.0 (1.8)	FCC



### 10-Day Quick Ship Ordering Guide Order Limit Per Fixture Selection: 15 – BC Pkg Code

LNC							
SERIES	NUMBER OF LEDS/SOURCE/VOLTAGE	CCT	IES DISTRIBUTION	FINISH	OPTIONS		
LNC LNC Zero uplight	<b>7LU</b> 7 LEDs, Universal voltage 120-277V <b>9LU</b> 9 LEDs, Universal voltage 120-277V	<b>4K</b> 4000K nominal, 80 CRI <b>5K</b> 5000K nominal, 67 CRI	<b>3</b> Type III <b>4</b> Type IV	<b>1</b> Bronze <b>2</b> Black <b>3</b> Gray <b>4</b> White <b>5</b> Platinum	<b>PC(X)<sup>1</sup></b> Button photo-control, replace X with voltage, specify 1-120V, 2-208V, 3-240V, 4-277V		

### MADE-TO-ORDER ORDERING INFORMATION – (BC PKG CODE)

LNC							
SERIES	NUMBER OF LEDS/SOURCE/VOLTAGE	CCT	IES DISTRIBUTION	FINISH	OPTIONS		
LNC LNC Zero uplight	<b>7LU</b> 7 LEDs, Universal voltage 120-277V <b>9LU</b> 9 LEDs, Universal voltage 120-277V	<b>3K</b> 3000K nominal, 80 CRI <b>AM<sup>2</sup></b> Amber (590 μm available for "Turtle Friendly"/observatory applications); Consult factory	<b>3</b> Type III <b>4</b> Type IV	<b>1</b> Bronze <b>2</b> Black <b>3</b> Gray <b>4</b> White <b>5</b> Platinum	<b>PC(X)<sup>1</sup></b> Button photo-control, replace X with voltage, specify 1-120V, 2-208V, 3-240V, 4-277V		

1 When PC is ordered, input must match PC voltage  
2 Amber LEDs are 035mA drive current

### DIMENSIONS

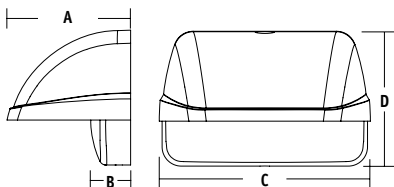

A	B	C	D
4.8"	1.6"	8.2"	5.3"
122 mm	39 mm	209 mm	133 mm

### PERFORMANCE INFORMATION

Series Number	Equivalency			Energy Savings
	MH	HPS	CFL	
LNC-5L	50w	50w	42w	85%
LNC-7L	70w	70w	42w	85%
LNC-9L	100w	100w	42w	85%





# LNC2

## Compact LED Wallpack – Zero Uplight

- IES Progress Award Winner - 2013
- Building Operating Management 2014 Top Products Award - LNC2-18LU
- DesignLights Consortium (DLC) qualified, Consult DLC website for more details: <http://www.designlights.org/QPL>

The compact LED LNC2, slightly larger than the LNC is designed for perimeter illumination for safety, security and general lighting application with typical mounting height up to 15 feet and 60ft fixture spacing (without acrylic diffuser) and 40ft spacing with acrylic diffuser installed.

### APPLICATIONS

Battery backup option in 12L versions for egress applications – provides 1 fc average over 16' L x 48' W at 11' mounting height. Zero uplight, IDA compliant entry/perimeter lighting. Listed to UL1598 for use in wet locations. Features long-life (60,000hr L96 rated), high CRI, 3000K, 4000K, and 5000K LEDs. Single SKU designed for both recessed box or surface conduit wiring, includes quick-mount adapter for ease of installation. Acrylic diffuser softens high angle output for use at entrances or pedestrian pathways.



LED WALLPACKS

### STOCK

### ORDERING INFORMATION

Catalog Number	System watts	delivered lumens	Voltage	CCT	# Drivers/ current	Mounting Height	Weight lbs. (kg)	PKG. CODE
LNC2-12LU-5K-3-1	28.6w	2420	120-277V	5000K	1@700mA	up to 11 ft.	7.0 (13.3)	FCC
LNC2-12LU-5K-3-1-PC-1	28.6w	2420	120V	5000K	1@700mA	10-12 ft.	7.0 (13.3)	FCC
LNC2-18LU-5K-3-1	44.5w	5311	120-277V	5000K	1@700mA	up to 15 ft.	7.0 (13.3)	FCC
LNC2-18LU-5K-3-1-PC-1	44.5w	5311	120V	5000K	2@700mA	up to 15 ft.	7.0 (13.3)	FCC



### 10-Day Quick Ship Ordering Guide Order Limit Per Fixture Selection: 15 – BC Pkg Code

SERIES	NUMBER OF LEDS/SOURCE/VOLTAGE	CCT	IES DISTRIBUTION	FINISH	OPTIONS
LNC2 LNC2 Zero uplight	12LU 12 LEDs, 29w input, Universal voltage 120-277V 18LU 18 LEDs, 42w input, Universal voltage 120-277V	4K 4000K nominal 70 CRI 5K 5000K nominal 67 CRI	3 Type III 4 Type IV	1 Bronze	PC1 Button photocontrol, 120V PC4 Button photocontrol, 277V

### MADE-TO-ORDER ORDERING INFORMATION – (BC PKG CODE)

SERIES	NUMBER OF LEDS/SOURCE/VOLTAGE	CCT	IES DISTRIBUTION	FINISH	OPTIONS
LNC2 LNC2 Zero uplight	7LU 7 LEDs, 16w input, Universal voltage 120-277V 9LU 9 LEDs, 22w input, Universal voltage 120-277V 12LU <sup>4</sup> 12 LEDs, 29w input, Universal voltage 120-277V 18LU 18 LEDs, 42w input, Universal voltage 120-277V 12L5 12 LEDs, 29w input, 480V 12L6 12 LEDs, 29w input, 347V	3K <sup>3</sup> 3000K nominal 80 CRI 4K 4000K nominal 70 CRI 5K 5000K nominal 67 CRI AM <sup>1</sup> Amber (590 μm available for "Turtle Friendly"/observatory applications, 350mA; consult factory	2 <sup>3</sup> Type II 3 Type III 4 Type IV	1 Bronze 2 Black 3 Gray 4 White 5 Platinum	PC(X) Button photocontrol, replace X with voltage, specify 1-120V, 2-208V, 3-240V, 4-277V BBU <sup>2</sup> Integral battery for 12L only (must specify 120V or 277V voltage in voltage category) rated for -20°C to 30°C

- 1 Amber LEDs only available on 18LU configurations, 350 mA only; Universal Voltage 120V-277V
- 2 Battery backup only available 12L models, not available for Canada
- 3 Does not qualify for DLC
- 4 Replace U with 1 for 120V or 4 for 277V for 12L with BBU

### DIMENSIONS

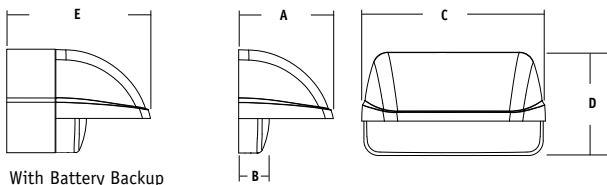

A	B	C	D	E	Weight	Weight w/BBU
6.25"	1.6"	10.25"	5.6"	10.25"	7.0 lbs.	15.0 lbs.
158.7 mm	40.2 mm	260.4 mm	142.2 mm	260.4 mm	3.2 kg	6.8 kg



**HUBBELL**  
Outdoor Lighting

# NRG<sup>®</sup> 300 Series

## Perimeter Wallpack

LED WALLPACKS



- Full polycarbonate front provides vandal resistance and uniform light distribution; Internally painted bronze finish for lasting appearance
- 12LED unit provides long-life with low energy consumption, a perfect upgrade for older units
- Rugged cast aluminum back housing for rigid mounting; Bottom 1/2" conduit knockout for surface conduit wiring
- Bronze finish
- Units available with or without 120V button photocontrol, see ordering information
- Tamper resistant center pin Torx hardware included
- Listed to UL1598 for use in wet locations

### STOCK

### ORDERING INFORMATION

Catalog Number	Wattage	Delivered Lumens	Voltage	CCT	Mounting Height	Drivers/Current	Weight lbs. (kg)	PKG. CODE
NRG-312LU-5K-BZ	18w	1120	120-277V	5000K	Up to 10 ft.	1@350mA	6 (2.7)	FCC
NRG-312LU-5K-BZ-PC	18w	1120	120V	5000K	Up to 10 ft.	1@350mA	6 (2.7)	FCC

### PERFORMANCE INFORMATION

Series Number	Equivalency			Energy Savings
	MH	HPS	CFL	
NRG-312LU	50w	50w	42w	73%

### STOCK

### ACCESSORIES - Order Separately

Catalog Number	Description	PKG. CODE
PBT-1	Button photocontrol, 120V	SCC
PBT-234	Button photocontrol, 208, 240, 277V	SCC

### MADE-TO-ORDER

### REPLACEMENT PART

Catalog Number	Description	PKG. CODE
SM352-COVER	Polycarbonate front cover, Bronze	BC

### DIMENSIONS

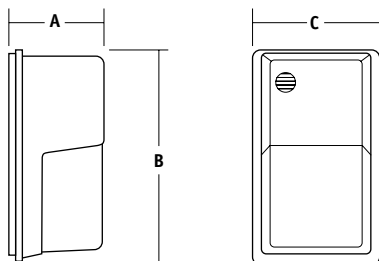

A	B	C
5.4"	11.0"	6.9"
137 mm	280 mm	175 mm



## Perimeter Glass Wallpack

- Two sizes: Medium and Large provides energy-efficient one-for-one replacement of existing legacy technology
- Mid power offers lower glare, better uniformity, higher efficiencies (up to 105 LPW) and lower thermals for longer lasting electronic components
- Borosilicate glass refractor softens LED and provides uniform distribution
- Medium size available in 4000K and 5000K
- Large size available in 4000K
- Cast aluminum frame holds lens, hinges to side of medium housing and hinges down on large housing; Seals with two stainless steel screws
- Cast aluminum housing with three 1/2" conduit entries (on top and sides) for button photocontrol or surface conduit
- All units have dark bronze powder paint finish
- Listed to UL1598 for use in wet locations



LED WALLPACKS

### STOCK

### ORDERING INFORMATION

Catalog Number	Wattage	Delivered Lumens	Voltage	CCT	Dist. Type	Mounting Height	Weight lbs. (kg)	# Drivers/Current	PKG. CODE
WGH-110L-4K-U-M	53w	4888	120-277V	4000K	4	Up to 15 ft.	12.0 (5.4)	1@140mA	FCC
WGH-225L-4K-U-L	97w	10151	120-277V	4000K	4	Up to 25 ft.	12.0 (5.4)	1@125mA	FCC

1 Chip on Board LED

### PERFORMANCE INFORMATION

Series Number	Equivalency			Energy Savings
	MH	HPS	CFL	
WGH-110L-4K-U-M	250w	250w	2x42w	78%
WGH-225L-4K-U-L	400w	400w	N/A	76%

### ACCESSORIES - Order Separately

Catalog Number	Description	PKG. CODE	SOURCE
PBT-1	Button photocontrol, 120V	SCC	STOCK
PBT-234	Button photocontrol, 208, 240, 277V	SCC	STOCK
SM708-GUARD	Wire guard for L Size	BC	MADE-TO-ORDER
SM708-FRAME/GLASS	Glass and door frame for L Size	BC	MADE-TO-ORDER

### DIMENSIONS

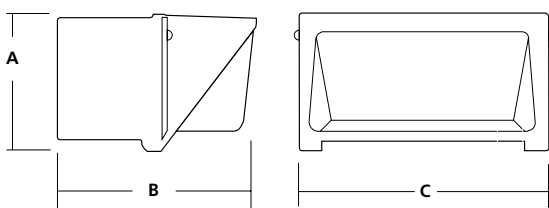

	A	B	C
Mid-Size	9.0" 229 mm	7.3" 184 mm	13" 330 mm
Large	9.0" 229 mm	13.0" 330 mm	17.0" 432 mm



**HUBBELL**  
Outdoor Lighting

# Perimaliter® PGM3 PVL3

## Glass and Polycarbonate LED Wallpacks

LED WALLPACKS



PGM3

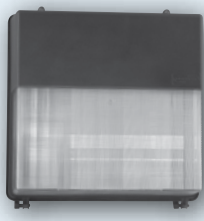

PVL3



- LED units provide 60-70% energy savings over typical pulse start wallpacks.
- Die-cast aluminum housing mounts over recessed junction boxes; 1/2" side hubs for surface conduit wiring; Top hub for use with button photo controls for dusk-to-dawn control;
- Two cover options are available: A cast aluminum with prismatic borosilicate glass assembly (PGM3) and an all polycarbonate, one-piece, vandal resistant door (PVL3)
- Typical mounting heights of 12-15 feet; with spacing of three to four times the mounting height
- BBU integral battery option for 120 or 277V, rated for -20°C to 25°C; designed to provide minimum of 1fc in a 10' square at 10-12' mounting height
- SCO/SCP - motion sensor on/off or user programmable
- Listed to UL1598 for use in wet locations

### STOCK ORDERING INFORMATION

Catalog Number	System watts	delivered lumens	Voltage	CCT	# Drivers/ current	Mounting Height	Weight lbs. (kg)	PKG. CODE
PGM3-30LU-4K-BZ	68w	5157	120-277V	4000K	2@700mA	15-18 ft.	20 (9)	SCC
PGM3-30LU-5K-BZ	68w	5678	120-277V	5000K	2@700mA	15-18 ft.	20 (9)	SCC
PVL3-30LU-4K-BZ	68w	4505	120-277V	4000K	2@700mA	15-18 ft.	13 (5.9)	SCC
PVL3-30LU-5K-BZ	68w	4873	120-277V	5000K	2@700mA	15-18 ft.	13 (5.9)	SCC



### 10-Day Quick Ship Ordering Guide Order Limit Per Fixture Selection: 15 – BC Pkg Code

FAMILY	# LEDES	VOLTAGE <sup>1</sup>	CCT	DRIVE CURRENT	FIXTURE COLOR	OPTIONS
PGM3 Glass Refractor	30L	U 120V-277V	4K 4000K, 70 CRI	BLANK 700mA	BZ <sup>5</sup> Bronze	PC1 Button photocontrol, 120V
PVL3 <sup>5</sup> Polycarbonate Refractor			5K 5000K, 67 CRI	035 <sup>3</sup> 350mA		PC4 Button photocontrol, 277V

### STOCK REPLACEMENT PARTS - Order Separately

Catalog Number	Description	PKG. CODE
200-0180-9904	Replacement lens/door PVL3	BC
80033990104	Replacement lens/door PGM3	BC
93044764	40w driver, 700mA, 120V-277V dimmable, 2x = 700mA, 1x = 350mA	BC
SCP-REMOTE <sup>2</sup>	Remote control for SCP option. Order at least one per project to program and control	BC

### PERFORMANCE INFORMATION

Series Number	Equivalency			Energy Savings
	MH	HPS	CFL	
PGM3	250w	250w	-	72%
PVL3	250w	250w	-	54%

### DIMENSIONS

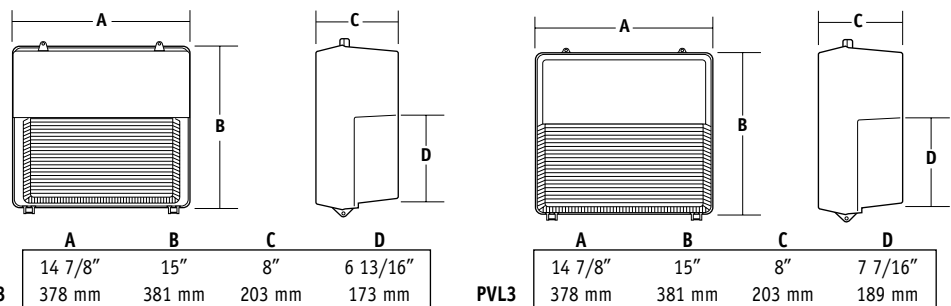

**HUBBELL**  
Outdoor Lighting

# Perimaliter® PGM3 PVL3

## Glass and Polycarbonate LED Wallpacks

LED WALLPACKS

### MADE-TO-ORDER ORDERING INFORMATION – (BC PKG CODE)

FAMILY		# LEDS	VOLTAGE <sup>1</sup>	CCT	DRIVE CURRENT	FIXTURE COLOR	OPTIONS
<b>PGM3</b>	Glass Refractor	<b>30L</b>	<b>U</b> 120V-277V	<b>3K</b> 3000K, 80 CRI	<b>BLANK</b> 700mA	<b>BZ<sup>5</sup></b> Bronze	<b>F<sup>1</sup></b> Fusing (voltage determined by voltage field) Single fusing only 120V, 277V or 347V
<b>PVL3<sup>5</sup></b>	Polycarbonate Refractor		<b>1</b> 120V <b>2</b> 208V <b>3</b> 240V <b>4</b> 277V <b>5</b> 480V <b>F</b> 347V	<b>4K</b> 4000K, 70 CRI <b>5K</b> 5000K, 67 CRI	<b>035<sup>3</sup></b> 350mA	<b>BL</b> Black <b>WH</b> White <b>GR</b> Gray <b>PL</b> Platinum <b>CC</b> Custom Color	<b>PC<sup>1</sup></b> Button photocontrol, (Must specify individual voltage) <b>BBU<sup>1,3</sup></b> Integral battery for 120 or 277V rated for -20°C to 25°C (Must specify individual voltage) <b>SCO<sup>2,4</sup></b> Motion sensor On/Off control, No light output when no motion detected <b>SCP<sup>2,4</sup></b> Programmable motion control, factory default is 10% <b>SP</b> Surge protector, 10KA 273 joules

1 Voltage specific option, designate in voltage field

2 0-10V fully adjustable dimming with automatic daylight calibration and different time delay settings, must order minimum of one remote to program dimming settings, 120V or 277V only

3 BBU only available in 350mA, 120V or 277V only

4 PC option not applicable, included in sensor. For SCP, PC function turns on to lower setting until motion is detected

5 PVL3 only available in BZ Bronze fixture color



**HUBBELL**  
Outdoor Lighting

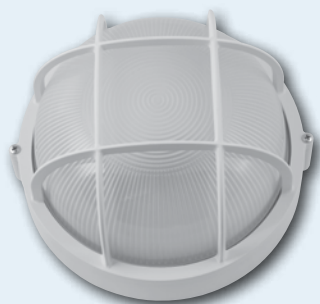

- Use for wall or ceiling applications at entrances, stairs, corridors or single story building accent
- Borosilicate glass lens with silicone gasket; Shields the lamp and softly spreads the light in a symmetrical distribution
- Die-cast aluminum housing and face trims; Two point lag mount or hickey mount to recessed wiring boxes; (no side conduit feeds); Twin stainless steel screws secure the trims and lens to the housing
- 50w HPS, 28w CFL (-20 degree starting) and 100w max incandescent
- BRLU LED unit available in 15w, 120-277V, 830 lumens, 5000K
- Lamp included on HPS and CFL sources
- Finishes in dark bronze, white and black
- Listed to UL1598 for use in wet locations

**MADE-TO-ORDER ORDERING INFORMATION - (BC PKG CODE)**

Catalog Number	Shape	Finish	Wattage	Volts	Weight lbs. (kg)	PKG. CODE
<b>LED (lamps included)<sup>4</sup></b>						
BRLU-01	Round	Bronze	15w	120-277V	6.0 (2.7)	BC
BRLU-04	Round	White	15w	120-277V	6.0 (2.7)	BC
<b>Incandescent - Medium Base Socket</b>						
BRI-01	Round	Bronze	100 max.	120V	4 (1.8)	BC
BRI-02	Round	Black	100 max.	120V	4 (1.8)	BC
BRI-04	Round	White	100 max.	120V	4 (1.8)	BC
BOI-01	Oval	Bronze	100 max.	120V	3.5 (1.6)	BC
BOI-02	Oval	Black	100 max.	120V	3.5 (1.6)	BC
BOI-04	Oval	White	100 max.	120V	3.5 (1.6)	BC
<b>High Pressure Sodium (lamp included)<sup>2</sup> - Medium Base Socket</b>						
BRS-01	Round	Bronze	50	120V	7.5 (3.4)	BC
BRS-02	Round	Black	50	120V	7.5 (3.4)	BC
BRS-04	Round	White	50	120V	7.5 (3.4)	BC
BOS-01	Oval	Bronze	50	120V	7 (3.2)	BC
BOS-02	Oval	Black	50	120V	7 (3.2)	BC
BOS-04	Oval	White	50	120V	7 (3.2)	BC
<b>Compact Fluorescent (lamp included)<sup>1, 3</sup></b>						
BRF-01	Round	Bronze	28	120V	6 (2.7)	BC
BRF-02	Round	Black	28	120V	6 (2.7)	BC
BRF-04	Round	White	28	120V	6 (2.7)	BC
BOF-01	Oval	Bronze	28	120V	5.5 (2.5)	BC
BOF-02	Oval	Black	28	120V	5.5 (2.5)	BC
BOF-04	Oval	White	28	120V	5.5 (2.5)	BC

1 Fluorescent CSA certified for outdoor applications only, not available in 277V (Alternate: see Hercules HVS Series)

2 Pulse-rated medium base socket

3 Two-pin fluorescent socket - PLC28, 2700K, -20°F starting

4 LED Color temperature 5000K, 6 LEDs at 700mA, 830 lumens, 120-277V, 50/60Hz

**MADE-TO-ORDER ACCESSORIES - Order Separately**

Catalog Number	Description	PKG. CODE
BO-GX <sup>1</sup>	Cast aluminum guard for oval fixture	BC
BR-GX <sup>1</sup>	Cast aluminum guard for round fixture	BC
BO-SX <sup>1</sup>	Cast aluminum shield for oval fixture	BC
BR-SX <sup>1</sup>	Cast aluminum shield for round fixture	BC



Shield

Guard

**STOCK**

**REPLACEMENT PARTS**

Catalog Number	Description	PKG. CODE
266-0067-9904	BR replacement lens	BC
266-0068-9904	BO replacement lens	BC

1 Finish must be specified, substitute X for: 1-bronze, 2-black, 4-white.

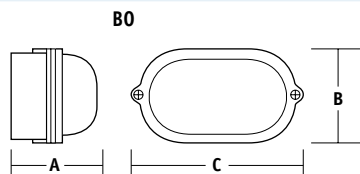
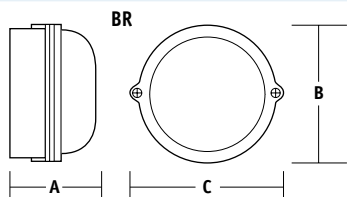

	A	B	C
BR Round	5 1/2"	9 1/2"	10 1/8"
	140 mm	241 mm	257 mm
BO Oval	5 1/2"	6 1/4"	11 1/4"
	140 mm	159 mm	286 mm



**HUBBELL**  
Outdoor Lighting

# NRG® 1100

## Compact Wallpack – Full Cut-off

Hubbell Outdoor Lighting's NRG® 1100 family is packed with owner benefits. The IDA compliant optics allow no up light, saving energy and keeping the neighbors happy!

Two sets of recessed closure screws are included – Phillips head and tamper resistant allen head.

For wall perimeter or entry at mounting heights of 8-15 feet. Decorative rugged styling with one piece polycarbonate front, painted bronze or white on the inside, that resists rocks and other small projectiles. The die-cast housing provides rigid mounting, conduit and photocontrol hubs, easy mount design and heat dissipation.

Listed to UL1598 for use in wet locations



HID WALLPACKS

### STOCK ORDERING INFORMATION

Catalog Number <sup>1</sup>	Wattage/Voltage	Finish	Weight lbs. (kg)	PKG. CODE
NRG-1111-W	100w PSMH, 120, 277, 347V	white	12 (5.4)	FCC
NRG-1171-B	70w PSMH, 120, 277, 347V	bronze	11 (5.0)	BC
NRG-1112-W	100w HPS, 120, 277, 347V	white	10 (4.5)	BC
NRG-1172-W	70w HPS, 120, 277, 347V	white	9 (4.1)	BC
NRG-1143-W	42w CFL, 120-277V, 60/50hz	white	7 (3)	FCC

<sup>1</sup> All fixtures include medium base or compact fluorescent lamps. CFL units use universal socket and are capable of operating 26 or 32w PLT lamps if substituted in the field; CFL lamps are 3500K, GX24q-4 base

### STOCK ACCESSORIES - Order Separately

Catalog Number	Description	PKG. CODE
PBT-1	Photocontrol, button type, 120V	SCC
PBT-234	Photocontrol, button type, 277V	SCC

### MADE-TO-ORDER REPLACEMENT PARTS

Catalog Number	Description	PKG. CODE
NRG1100FHB	Polycarbonate front housing-bronze, 70w max.	BC
NRG1100FHW	Polycarbonate front housing-white, 70w max.	BC
NRG1111FHB	Polycarbonate front housing-bronze, 100w max.	BC
NRG1111FHW	Polycarbonate front housing-white, 100w max.	BC

#### DIMENSIONS

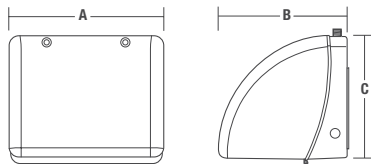

A	B	C
11 3/4"	9 1/2"	9 1/2"
298 mm	241 mm	241 mm

# WMR

- Accent wall sconces for mounting heights of 8-12 ft
- Shipped as full cut-off downlight
  - Units have a removable internal shield that allows up/down distribution
- UV stabilized polycarbonate front
- Die-cast housing provides rigid mounting and dissipates ballast/lamp heat
- Silicone gasket seals out moisture and insects
- CFL units feature 120V photocontrol for dusk to dawn energy saving control
- 70w PSMH units have Tri-Tap® ballast (120, 277, 347V) and are shipped less photocontrol; PBT-1 or PBT-234 may be field installed if photocontrol is desired
- Listed to UL1598 for use in wet locations



### STOCK ORDERING INFORMATION

Catalog Number <sup>1</sup>	Shape	Wattage	Voltage	Photocontrol	Weight lbs. (kg)	PKG. CODE
WMR-42F1-PC	Radius	42w CFL	120	Yes	6.0 (2.7)	BC
WMR-70P6	Radius	70w PSMH	120, 277, 347	No	11.0 (5.0)	BC

<sup>1</sup> All units have molded-in dark bronze finish and include lamps; CFL 2 x 13w lamps are PLC, 42w lamp is PLT; Lamps are 3500K

#### DIMENSIONS

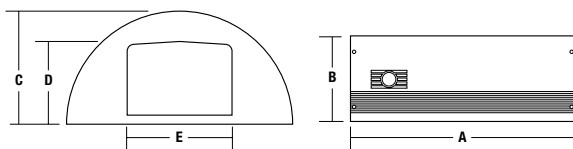

	A	B	C	D	E
WMR	14.6"	5.5"	7.3"	4.8"	6.7"
	370 mm	140 mm	185 mm	121 mm	170 mm



**HUBBELL**  
Outdoor Lighting



# WGC Series

## Compact Wallpacks – Full Cut-off

HID WALLPACKS



- Rugged cast aluminum housing and door provide rigid mounting to surface
- Full cut-off distribution with factory installed shield (Shield can be removed in the field if more forward throw is desirable)
- Tempered stippled glass lens increases distribution spread and softens lamp image
- Typical mounting height is 8-12'
- Dark bronze powder paint finish protects surfaces and appearance
- Listed to UL1598 for use in wet locations
- Lamps are included

### STOCK

### ORDERING INFORMATION

Catalog Number <sup>1</sup>	Wattage/Source	Voltage	Finish	Weight lbs. (kg)	PKG. CODE
<b>Compact Series - Medium Base Socket<sup>1</sup></b>					
<b>WGC-70H</b>	70w PSMH	120, 208, 240, 277V	Bronze	11 (5.0)	<b>FCC</b>
<b>WGC-100H</b>	100w PSMH	120, 208, 240, 277V	Bronze	12 (5.4)	<b>FCC</b>
<b>Compact Fluorescent<sup>1</sup></b>					
<b>WGC-42F<sup>2</sup></b>	42w CFL	120-277V	Bronze	8 (3.6)	<b>FCC</b>

<sup>1</sup> Lamp included on all units

<sup>2</sup> CFL lamps are 3500K 4-Pin, GX24q-4 base, 120-277V, 50/60 Hz

### STOCK

### ACCESSORIES - Order Separately

Catalog Number	Description	PKG. CODE
<b>PBT-1</b>	Photocontrol, button type, 120V	<b>SCC</b>
<b>PBT-234</b>	Photocontrol, button type, 277V	<b>SCC</b>

### DIMENSIONS

Compact Series

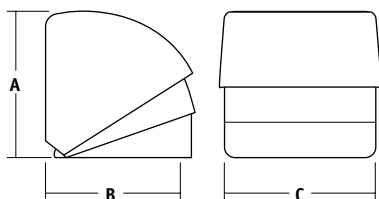

	A	B	C
<b>Compact</b>	8.8"	8.2"	8.75"
	224 mm	208 mm	222 mm

# NRG<sup>®</sup> 31X

## Shielded Wallpack – Full Cut-off

- Clear polycarbonate lens with recessed phillips head retaining screws; An undercut fit provides water shedding, wet location listing
- Cast aluminum housing mounts to recessed junction boxes and provides lamp arc tube shielding at 90 degrees
- 4 to 1 spacing to mounting height ratio with two mounting height forward throw
- Additional shielding can be added in the field by applying the light trespass inhibitor (included) along the lens, top or sides
- Available in 50 and 70w HPS or 50w PSMH 120/277V; Lamp included
- Dark bronze powder paint finish
- Listed to UL 1598 for use in wet locations

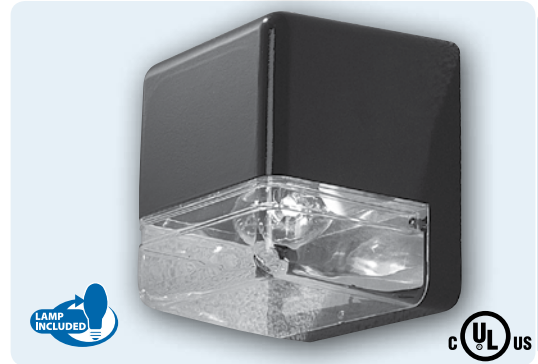

HID WALLPACKS

### STOCK

### ORDERING INFORMATION

Catalog Number	Wattage	Voltage	Ballast Type	Weight lbs. (kg)	PKG. CODE
<b>High Pressure Sodium</b>					
NRG-311	50	120/277	AL-HPF	6.5 (3)	BC
NRG-317	70	120/277	AL-HPF	7.5 (3.4)	BC
<b>Pulse Start Metal Halide</b>					
NRG-315	50	120/277	AL-HPF	6.5 (3)	BC

Note All units have dark bronze powder paint finish, 120/277 dual voltage ballasts, and include medium base lamp  
 Note No options or accessories available.

### DIMENSIONS

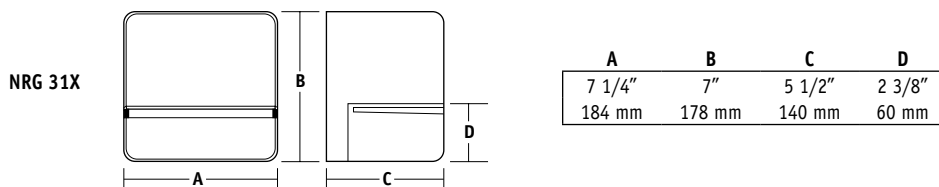

**HUBBELL**  
Outdoor Lighting

# Perimaliter® PVL3

## Vertical Lamp Position Polycarbonate Refractor Wallpack

HID WALLPACKS

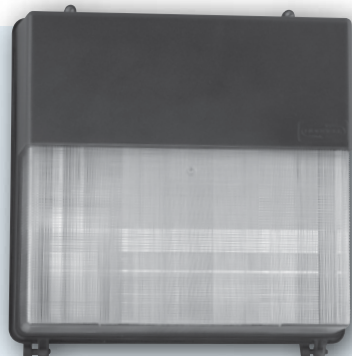

- One-piece polycarbonate lens, internally painted for lasting appearance; 6 to 1 spacing to mounting height ratio; Two HubbellGard® fasteners provide weathertight seal to housing; Door hinges and is removable
- Housing is die-cast aluminum for rugged mounting and heat dissipation; 1/2" feed-through hubs provided and top photocontrol hub location for field installation; Standard mount is over recessed wiring boxes; Fixtures have dark bronze finish
- Specular reflector, vertical lamps and refractor combine for efficient and uniform perimeter lighting; PVL3 is 150w max; 50 Hz ballastry available
- Socket is porcelain medium base with spring-loaded center contact
- Accessories: Photocontrols/ Full cut-off visors
- CFL egress units provide redundant lamp and battery backup
- Listed to UL1598 for use in wet locations

### STOCK ORDERING INFORMATION

Catalog Number <sup>1</sup>	Wattage	Lamp Type	Voltage	Ballast	Lamp Included	Weight lbs. (kg)	PKG. CODE
PVL3-100P-18-BZ-L	100	PSMH	Quad Tap	HX-HPF	Yes	20 (9.0)	BC
PVL3-150P-18-BZ	150	PSMH	Quad Tap	HX-HPF	No	20 (9.0)	BC
PVL3-150P-18-BZ-L	150	PSMH	Quad Tap	HX-HPF	Yes	20 (9.0)	BC
PVL3-070S-18-BZ	70	HPS	Quad Tap	AL-HPF	No	18 (8.1)	BC
PVL3-100S-18-BZ	100	HPS	Quad Tap	AL-HPF	No	19 (8.6)	BC
PVL3-100S-18-BZ-L	100	HPS	Quad Tap	AL-HPF	Yes	19 (8.6)	BC
PVL3-150S-18-BZ	150	HPS	Quad Tap	AL-HPF	No	20 (9.0)	BC
PVL3-150S-18-BZ-L	150	HPS	Quad Tap	AL-HPF	Yes	20 (9.0)	BC
PVL3-150S-51-BZ-L	150	HPS	120V NPF	HX-NPF	Yes	7 (3.1)	BC
PVL3-242F-18-BZ-L	2x42	CFL	Quad Tap	-	GX24q-4 base	12.0 (5.4)	BC
PVL3-242F-18-BZ-L-2BOC <sup>2</sup>	2x42	CFL	Quad Tap	With twin battery backup	GX24q-4 base	17.0 (7.7)	BC

#### PVL3 – Egress<sup>2</sup>

- Notes:
- Lamps included, 4100K
  - 2 BOC batteries rated 0°C (32°F) to 50°C (122°F) ambients (typical fixture ambient is 32°F-77°F)
  - Each lamp supported by individual ballast
  - Electronic ballasts operate on voltage between 120-277V, 50/60 Hz

#### PVL3 – HID<sup>1</sup>

- L - Indicates lamp included with the fixture
- Above units (-18) are Quad Tap (120,208,240,277V); 480V available as Made-to-order on 150w unit, change -18 to -15
- For TriTap Canadian ballast (120,277,347V) change 18 to 16 (Made-to-order)
- All units are provided in BZ - dark bronze finish
- 50 Hz ballastry available - consult factory for availability

### STOCK ACCESSORIES - Order Separately

Catalog Number	Description
PBT-1	Photocontrol, button type, 120V
PBT-234	Photocontrol, button type, 208, 240, 277V
PVL3V	Full cut-off visor, formed aluminum, bronze finish

#### REPLACEMENT PARTS

Catalog Number	Description
200-0180-9904	Polycarbonate front
80033990104	Aluminum/glass front, bronze (glass conversion)

### MADE-TO-ORDER OPTIONS - Add Suffix

Catalog Number	Description
-EM	Double contact socket for remote power (less lamp) all units
-QSS	Quartz restrike system including relay (less lamp) all units (Double contact bayonet socket)
-UST	Substantially transformed version in the U.S. meeting level 2 of the Buy American Act

#### DIMENSIONS

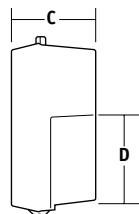
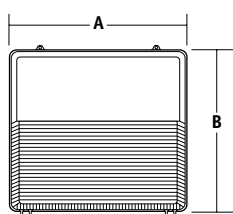

	A	B	C	D
PVL3	14 7/8"	15"	8"	7 7/16"
	378 mm	381 mm	203 mm	189 mm



# Perimaliter® PGM3

## Vertical Lamp Position Glass Refractor Wallpack

- Cast aluminum door with borosilicate glass refractor; Bottom hinge allows door removal; Twin HubbellGard® screw closure for positive seal
- Cast aluminum back housing provides firm mounting and heat dissipation; Mounts over recessed wiring boxes; Has two 1/2" conduit hubs for feed-through wiring. Top hub for field installation of photocontrol
- Specular aluminum reflector, vertical lamp and refractor prisms combine for excellent perimeter lighting; Provides 5 times spacing-to-mounting height
- PGM3 is 250w max
- Socket is porcelain medium base with spring-loaded center contact, for all offerings below 250w; 250w units are mogul base
- Bronze powder paint finish is standard, other finishes available, consult factory
- Listed to UL1598 for use in wet locations



HID WALLPACKS

### STOCK

### ORDERING INFORMATION

Catalog Number	Wattage	Lamp Type	Voltage	Ballast	Lamp Included/Base	Weight lbs. (kg)	PKG. CODE
PGM3-100P-18-BZ-L	100	PSMH	Quad Tap	HX-HPF	Yes/Med.	25 (11.3)	BC
PGM3-150P-18-BZ	150	PSMH	Quad Tap	HX-HPF	No/Med.	25 (11.3)	BC
PGM3-150P-18-BZ-L	150	PSMH	Quad Tap	HX-HPF	Yes/Med.	25 (11.3)	BC
PGM3-250P-18-BZ	250	PSMH	Quad Tap	CWA-HPF	No/Mog.	27 (12.2)	BC
PGM3-250P-18-BZ-L	250	PSMH	Quad Tap	CWA-HPF	Yes/Mog.	27 (12.2)	BC
PGM3-070S-18-BZ	70	HPS	Quad Tap	AL-HPF	No/Med.	23 (10.4)	BC
PGM3-100S-18-BZ	100	HPS	Quad Tap	AL-HPF	No/Med.	24 (10.9)	BC
PGM3-150S-18-BZ-L	150	HPS	Quad Tap	AL-HPF	Yes/Med.	25 (11.3)	BC
PGM3-250S-18-BZ	250	HPS	Quad Tap	CWA-HPF	No/Mog.	30 (13.6)	BC
PGM3-250S-18-BZ-L	250	HPS	Quad Tap	CWA-HPF	Yes/Mog.	33 (14.9)	BC
PGM3-LB	250Max	None	None	None	No/Mog.	15 (6.8)	BC
PGM3-LB	250Max	None	None	None	No/Mog.	15 (6.8)	BC

- Notes:
- L - Indicates lamp included with the fixture
  - Above units (-18) are Quad Tap (120,208,240,277V) 480V available on 150/250w units, change 8 to 5
  - For TriTap Canadian ballast (120,277,347V) change 8 to 6
  - BZ - Dark Bronze finish is standard; For alternate finish - consult factory for price adder and availability
  - BL - Black, GR - Gray, WH - White, PS - Platinum
  - 50HZ ballast is available - consult factory
  - Less ballast

### STOCK

### REPLACEMENT PART

Catalog Number	Description
80033990104	Lens door assembly, bronze

### STOCK

### ACCESSORIES - Order Separately

Catalog Number	Description	PKG. CODE
PBT-1	Photocontrol, button type, 120V	SCC
PBT-234	Photocontrol, button type, 208, 240, 277V	SCC
PG-PS <sup>1</sup>	Polycarbonate shield for refractor	BC
PG-WG <sup>1</sup>	Wire guard for refractor	BC
PVL3V	Full cut-off visor, formed aluminum, bronze finish	BC

<sup>1</sup> Guard and shield can be used on the same fixture

### MADE-TO-ORDER

### OPTIONS - Add Suffix

Catalog Number	Description
-EM	Double contact socket for remote power (less lamp) all units
-QSS	Quartz restrike system including relay (less lamp) all units (double contact bayonet socket)
-UST	Substantially transformed version in the U.S. meeting level 2 of the Buy American Act

### DIMENSIONS

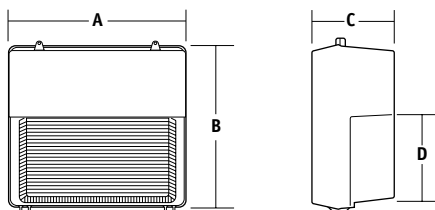

	A	B	C	D
PGM3	14 7/8"	15"	8"	6 13/16"
	378 mm	381 mm	203 mm	173 mm



**HUBBELL**  
Outdoor Lighting

# Perimaliter® PGL

## Vertical Lamp Position Glass Refractor Wallpack

HID WALLPACKS



- Cast aluminum door with borosilicate glass refractor; Bottom hinge allows door removal; Twin HubbellGard® screw closure for positive seal
- Cast aluminum back housing provides firm mounting and heat dissipation; Mounts over recessed wiring boxes; Has two 1/2" conduit hubs for feed-through wiring; Side hub for field installation of photocontrol
- Specular aluminum reflector, vertical lamp position and refractor prisms combine for excellent perimeter lighting; Provides 5 times spacing to mounting height
- PGL is mogul base 250-400w max
- Bronze powder paint finish is standard, other finishes available, consult factory
- Listed to UL1598 for use in wet locations

### STOCK ORDERING INFORMATION

Catalog Number	Wattage	Lamp Type	Voltage	Ballast	Lamp Included	Weight lbs. (kg)	PKG. CODE
PGL-250P-128-1-LP	250	PSMH	Quad Tap	CWA-HPF	Yes	30 (13.6)	BC
PGL-350P-128-1-LP	350	PSMH	Quad Tap	CWA-HPF	Yes	27 (15.0)	BC

### MADE-TO-ORDER ORDERING INFORMATION

Catalog Number	Wattage	Lamp Type	Voltage	Ballast	Lamp Included	Weight lbs. (kg)	PKG. CODE
PGL-250P-128-1-LP	250	PSMH	Quad Tap	CWA-HPF	Yes	30 (13.6)	BC
PGL-350P-128-1-LP	350	PSMH	Quad Tap	CWA-HPF	Yes	27 (15.0)	BC
PGL-250S-128-1	250	HPS	Quad Tap	CWA-HPF	No	32 (14.5)	BC
PGL-400S-128-1	400	HPS	Quad Tap	CWA-HPF	No	36 (16.3)	BC
PGL-400S-128-1-LP	400	HPS	Quad Tap	CWA-HPF	Yes	36 (16.3)	BC

Notes: • LP - Indicates lamp included with the fixture.

- Above units are Quad Tap (120,208,240,277V ED28 lamps are required)
- For Tri-Tap Canadian ballast (120,277,347 volt) change 8 to 6
- Dark Bronze finish (-1) is standard; For alternate finish (2- Black, 3- Gray, 4- White) - consult factory for price adder and availability
- 50Hz ballastry is available - Consult factory

### STOCK ACCESSORIES - Order Separately

Catalog Number	Description	PKG. CODE
PBT-1	Photocontrol, button type, 120V	SCC
PBT-234	Photocontrol, button type, 208, 240, 277V	SCC
PTA-8	Photocontrol, external, weather tight, 208, 240, 277V	BC
PG-PS <sup>1</sup>	Polycarbonate shield for refractor	BC
PG-WG <sup>1</sup>	Wire guard for refractor	BC
PVL3V	Full cut-off visor, formed aluminum, bronze finish	BC

<sup>1</sup> Guard and shield can be used on the same fixture

### OPTIONS - Add Suffix

Catalog Number	Description
-EM	Double contact socket for remote power (less lamp) all units
-QSS	Quartz restrike system including relay (less lamp) all units (Double contact bayonet socket)
-UST	Substantially transformed version in the U.S. meeting level 2 of the Buy American Act

### STOCK REPLACEMENT PART

Catalog Number	Description	PKG. CODE
80033990104	Lens door assembly, bronze	BC

### DIMENSIONS

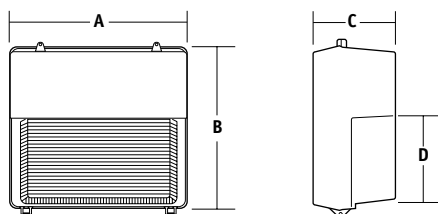

	A	B	C	D
PGL	14 7/8"	15"	9 7/8"	6 13/16"
	378 mm	381 mm	251 mm	173 mm

# WGH/WPH

## Glass Wallpacks – Horizontal Lamp

- Borosilicate glass refractor softens lamp image and provides uniform distribution - 4 times spacing to mounting height
- Cast aluminum frame holds lens, hinges to side of housing and seals with two stainless steel screws
- Cast aluminum housing with 1/2" conduit entries, button photocontrol can be field installed

- WGH Mid-size is 150w PSMH; WGH large handles 250-400w
- WGH-70/100 compact size PSMH and HPS
- Listed to UL1598 for use in wet locations
- All units have dark bronze powder paint finish, Quad-Tap® ballasts and lamps included; 150w PSMH is shipped with medium base lamp; All other HID wattages include mogul base lamp

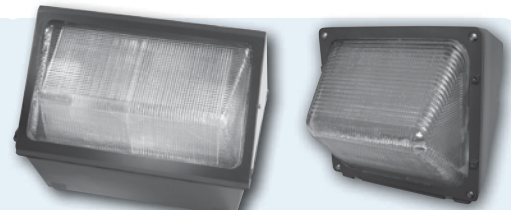

WGH 150-400

PSMH WGH 70-100

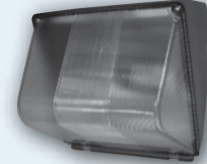

HPS WPH 70-100



### STOCK ORDERING INFORMATION

Catalog Number <sup>1</sup>	Size	Wattage/Source	Voltage	Finish	Lamp	Weight lbs. (kg)	PKG. CODE
WGH-150P	Mid-Size	150w PSMH	120, 208, 240, 277V	Bronze	Included	19 (8.6)	FCC
WGH-150S	Mid-Size	150w HPS	120, 208, 240, 277V	Bronze	Included	18 (8.2)	FCC
WGH-150S120	Mid-Size	150w HPS	120V	Bronze	Included	15 (6.8)	FCC
WGH-250P	Large	250w PSMH	120, 208, 240, 277V	Bronze	Included	34 (15.4)	FCC
WGH-400P	Large	400w PSMH	120, 208, 240, 277V	Bronze	Included	37 (16.8)	FCC

Catalog Number	Source/ Lens	Wattage/Voltage	Finish	Start Temperature	Weight lbs. (kg)	PKG. CODE
WPH-70S	HPS - Polycarbonate/Lens	70 HPS 120V	Bronze	-40°F	8 (3.6)	FCC
WGH-70H	PSMH - Glass Refractor	70 PSMH 120/208/240/277V	Bronze	-20°F	9 (4.1)	FCC
WGH-100H	PSMH - Glass Refractor	100 PSMH 120/208/240/277V	Bronze	-20°F	10 (4.5)	FCC

### STOCK ACCESSORIES - Order Separately

Catalog Number	Description	PKG. CODE
PBT-1	Photocontrol - button type 120V	SCC
PBT-234	Photocontrol - button type 208, 240, 277V	SCC
PTA -8	Photocontrol - external stem mount 120, 240, 277V	BC

### MADE-TO-ORDER ACCESSORIES - Order Separately

Catalog Number	Description	PKG. CODE
SM708-GUARD	Wireguard for large fixtures	BC
SM708-VISOR	Top visor for large fixtures	BC

### MADE-TO-ORDER REPLACEMENT PARTS

Catalog Number	Description	PKG. CODE
SM708-REPLGL	Glass only for WGH-250/400	BC
SM708-FRAME/GLASS	Lens door assembly for WGH-250/400	BC
SM704-REPLGL	Glass only for WGH-70H/100H	BC
SM704-FRAME/GLASS	Lens door assembly for WGH-70H/100H	BC
SM705-LENS	Polycarbonate refractor only for WPH-70S/100S	BC

### DIMENSIONS -WGH 84/150/250/400

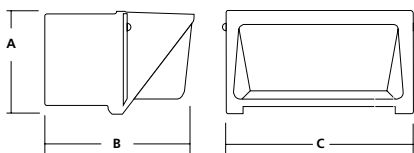

	A	B	C
Mid-Size	9"	7.25"	13"
	229 mm	184 mm	330 mm
Large	9"	13"	17"
	229 mm	330 mm	432 mm

### DIMENSIONS -WPH/WGH 70/100

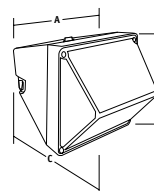

A	B	C
8 1/2"	8 1/2"	8 1/2"
216 mm	216 mm	216 mm



**HUBBELL**  
Outdoor Lighting



# NRG<sup>®</sup> 200B

## Decorative Perimeter Wallpack

HID WALLPACKS



- Decorative polycarbonate front provides vandal resistance and efficient spread; Typical mounting height is up to 10 feet; Internally painted bronze finish for lasting appearance
- Rugged cast aluminum back housing for rigid mounting; Bottom 1/2" conduit knockout for surface conduit wiring (except on 'MS' unit); Back hub allows access to recessed wiring boxes; Two point mounting
- Motion controlled unit has 180° detection range – saves energy by providing illumination only when needed
- Motion sensor unit features multiple control settings - for more energy savings
- Most units available with or without 120V button photocontrol, see ordering information
- Tamper resistant center pin Torx hardware included for vandal prone applications
- Lamp included
- Listed to UL1598 for use in wet locations

### STOCK ORDERING INFORMATION

Catalog Number <sup>1</sup>		Wattage	Voltage	Color	Weight lbs. (kg)	PKG. CODE
Without Photocontrol	With Photocontrol					
<b>Pulse Start Metal Halide</b>						
NRG-250B	NRG-250B-PC <sup>1,2</sup>	50w	120V <sup>2</sup>	Bronze	6.5 (2.9)	FCC
<b>Electronic Fluorescent<sup>3</sup></b>						
NRG-204B	NRG-204B-PC <sup>1</sup>	42w	120-277V (-PC120)	Bronze	4.2 (1.9)	FCC
-	NRG-206B-PC <sup>1</sup>	26w	120V	Bronze	4.2 (1.9)	FCC
<b>Motion Controlled Electronic Fluorescent<sup>3</sup></b>						
NRG-204B-MS <sup>4</sup>		42w	120V	Bronze	6.0 (2.7)	FCC

- 1 120V only when ordered with photocontrol
- 2 120V NPF ballast for H.I.D.
- 3 CFL lamps are 4-Pin, 3500K
- 4 Motion sensor has 180° detection range, adjustable time-on and sensitivity settings

### STOCK ACCESSORIES - Order Separately

Catalog Number	Description	PKG. CODE
PBT-1	Button photocontrol, 120V	BC
PBT-234	Button photocontrol, 208, 240, 277V	BC

### STOCK REPLACEMENT PART

Catalog Number	Description	PKG. CODE
NRG200BLENS	Polycarbonate front cover, bronze	BC

### DIMENSIONS

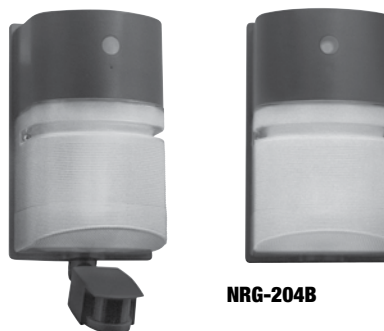
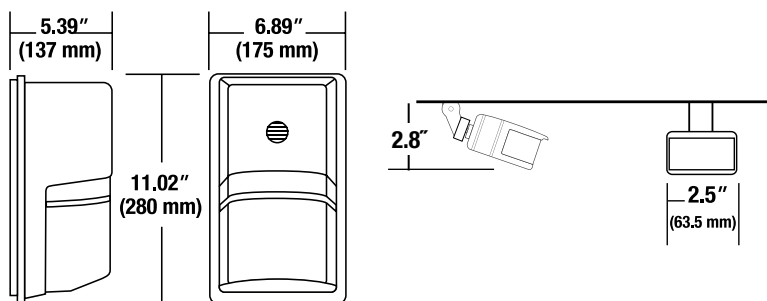



# NRG<sup>®</sup> 300B

## Perimeter Wallpack

- Full polycarbonate front provides vandal resistance and efficient spread; Lateral coverage on HID units is 5 times the typical mounting height up to 10 feet; Internally painted bronze finish for lasting appearance; Fluorescent photocontrol version available in white
- Motion controlled unit has 180° detection range – saves energy by providing illumination only when needed
- Lamp included
- Rugged cast aluminum back housing for rigid mounting; Bottom 1/2" conduit knockout for surface conduit wiring (except on 'MS' unit); Back hub allows access to recessed wiring boxes; Two point mounting
- Units available with or without 120V button photocontrol, see ordering information
- Listed to UL1598 for use in wet locations
- Tamper resistant center pin Torx hardware included



HID WALLPACKS

### STOCK ORDERING INFORMATION

Catalog Number <sup>1</sup>		Wattage	Voltage	Color	Weight lbs. (kg)	PKG. CODE
Without Photocontrol	With Photocontrol					
<b>High Pressure Sodium</b>						
NRG-301B	NRG-301B-PC <sup>1,2</sup>	50w	120V	Bronze	5 (2.3)	FCC
NRG-307B	NRG-307B-PC <sup>1,2</sup>	70w	120V	Bronze	5 (2.3)	FCC
<b>Pulse Start Metal Halide</b>						
NRG-350B	NRG-350B-PC <sup>1,2</sup>	50w	120V	Bronze	6.5 (2.9)	FCC
<b>Electronic Fluorescent<sup>3</sup></b>						
–	NRG-306B-PCW <sup>1</sup>	26w	120-277V (-PC120)	White	4.2 (1.9)	FCC
–	NRG-306B-PC <sup>1</sup>	26w	120-277V (-PC120)	Bronze	4.2 (1.9)	FCC
–	NRG-304B-PCW <sup>1</sup>	42w	120-277V (-PC120)	White	4.2 (1.9)	FCC
NRG-304B	NRG-304B-PC <sup>1</sup>	42w	120-277V (-PC120)	Bronze	4.2 (1.9)	FCC
<b>Motion Controlled Electronic Fluorescent<sup>3</sup></b>						
–	NRG-304B-MS <sup>4</sup>	42w	120V	Bronze	6 (2.7)	FCC

- Lamp included
- 120V NPF ballast for HID
- CFL lamps are 4-Pin, 3500K, GX24q-4
- Motion sensor has 180° detection range, adjustable time-on and sensitivity settings

### STOCK ACCESSORIES - Order Separately

Catalog Number	Description	PKG. CODE
PBT-1	Button photocontrol, 120V	SCC
PBT-234	Button photocontrol, 208, 240, 277V	SCC

### MADE-TO-ORDER REPLACEMENT PART

Catalog Number	Description	PKG. CODE
SM352-COVER	Polycarbonate front cover, Bronze	BC



NRG-304B-MS

### DIMENSIONS

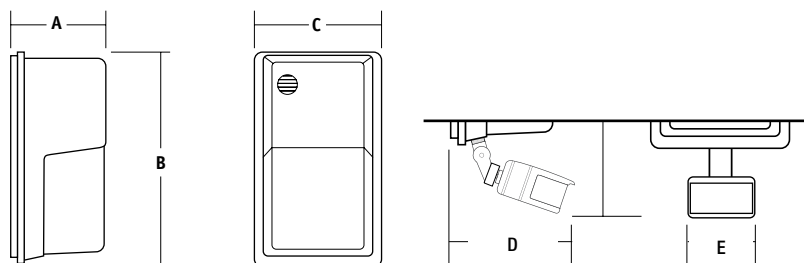

A	B	C	D	E
5.39"	11.02"	6.89"	6.50"	2.5"
137 mm	280 mm	175 mm	165 mm	63.5 mm



Dual-Lite  
Ridgeline Battery Fixture  
for 42w CFL egress unit with  
battery back-up



**HUBBELL**  
Outdoor Lighting

## Ceiling/Canopy/Garage LED Luminaire

LED CEILING/CANOPY/GARAGE

**NEW**

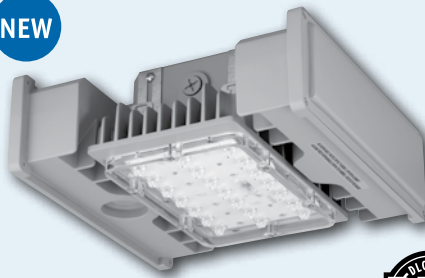

- Designed for a range of ceiling applications from eight to fifteen feet for junction box or pendant mount; Parking garage, walkway or building canopies, corridors, tunnels, large stairwells and other cover applications; Two lumen packages and two optical distributions make the the GSL Series luminaire both versatile and functional
- Vertically finned cast aluminum housing for maximum heat dissipation ensuring long component life and performance
- Wattage: 53.3w or 74w, >81 LPW
- Gray powder coat paint finish
- IP66 luminaire rating, Listed to UL1598 for use in wet locations
- Field configurable symmetric and asymmetric optic in a single SKU
- DesignLights Consortium qualified
- Two 1/2" threaded hubs for accessories
- CCT: 4000K (70 CRI)
- Lumen packages ranging from 4,500 – 6,100 with 15 or 21 LEDs
- Designed for 40° C ambient temperatures
- Hinged mounting plate standard, allows single person installation

**STOCK ORDERING INFORMATION**

Catalog Number	System watts	delivered lumens	Voltage	CCT	# Drivers/ current	Mounting Height	Weight lbs. (kg)	PKG. CODE
GSL-15L	53.3w	4524	120-277V	4000K	1@1050mA	8-12 ft.	13.8 (6.2)	BC
GSL-21L	74w	6138	120-277V	4000K	1@1050mA	12-15 ft.	13.8 (6.2)	BC

**PERFORMANCE INFORMATION**

Series Number	Equivalency			Energy Savings
	MH	HPS	CFL	
GSL-15L	150w	150w	84w+	72%
GSL-21L	250w	250w	84w+	54%

**MADE-TO-ORDER ACCESSORIES/REPLACEMENT PARTS - Order Separately (field installed)**

Catalog Number	Description	PKG. CODE
GSL-SPC	Vandal shield, polycarbonate	BC
GSL-CS	Comfort shield, acrylic, improved uniformity, 10-15% lumen reduction	BC
93048453	Programmable motion sensor (High/low or on/off capability, user programmable low settings)	BC
95005520	Motion sensor lens (wide lens, 48 ft. diameter, 16ft. maximum mounting height)	BC
PTA-1	120V button photocell with 1/2" thread	BC
PTA-8	120V - 277V button photocell with 1/2" thread	BC
SCP-REMOTE	Infrared IR remote control to program motion sensor (Minimum 1 required per project)	BC
GSL-MTG-PL	Hinged mounting plate	BC
GSL-LENS-M	LED lens for symmetrical Type V	BC
GSL-LENS-R	LED lens for asymmetrical Type II rectangular	BC
GSL-Protector	15KA surge protector	BC

**DIMENSIONS**

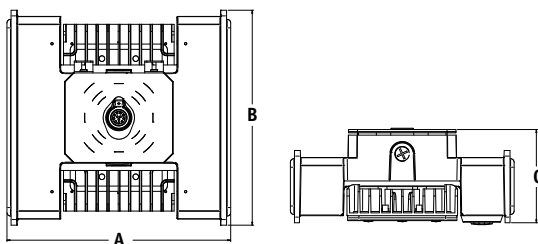

A	B	C	Weight
12.5" sq.	12.0"	5.2"	13.8 lbs.
317.5 mm	304 mm	132 mm	6.25 kg



# Lumasquare® NRG® 4000

## High Performance LED Indoor/Outdoor Lowbay Series

- Designed for illumination of commercial indoor/outdoor lowbay applications including: mechanical rooms, retail, covered loading docks and utility areas
- Rugged, die-cast housing has a durable powder coat paint finish available in bronze, white, black and gray; Mounts over recessed J-box and features two convenient 1/2" side hubs for surface conduit mounting
- Stainless steel vandal-resistant screws standard
- Fully gasketed for weatherproof/bug-proof integrity
- 4000K CCT (70 CRI) nominal and 5000K CCT (67 CRI) nominal
- One-piece, injection-molded, clear prismatic acrylic refractor enhances space with 10% uplight; High temperature acrylic for reduced yellowing, uniform light distribution and low glare
- Listed to UL1598 for use in wet locations
- Five year limited warranty
- 10KA, 10KV surge protector standard
- 4000K, 700mA model DesignLights Consortium (DLC) qualified



LED CEILING/CANOPY/GARAGE

### STOCK ORDERING INFORMATION

Catalog Number	System watts	delivered lumens	Voltage	CCT	# Drivers/ current	Mounting Height	Weight lbs. (kg)	DesignLights CONSORTIUM	PKG. CODE
NRG4-30LU-4K-BZ	70	5872	120-277V	4000K	2@700mA	up to 16 ft.	13.9 (6.3)		BC
NRG4-30LU-5K-BZ	70	6122	120-277V	4000K	2@700mA	up to 16 ft.	13.9 (6.3)	N/A	BC



### 5-Day Quick Ship Ordering Guide Order Limit Per Fixture Selection: 15 – BC Pkg Code

Catalog Number	System watts	delivered lumens	Voltage	CCT	# Drivers/ current	Mounting Height	Weight lbs. (kg)	PKG. CODE
NRG4-30LU-4K-035-BZ	35	3355	120-277V	4000K	1@350mA	up to 16 ft.	13.9 (6.3)	BC
NRG4-30LU-5K-035-BZ	35	3543	120-277V	5000K	1@350mA	up to 16 ft.	13.9 (6.3)	BC

1 For alternate housing finish change BZ to WH-White, BL-Black, GR-Gray (Made-To-Order only)

### STOCK REPLACEMENT PART

Catalog Number	Description
800-3289-0100	Replacement refractor kit

### PERFORMANCE INFORMATION

Series Number	Equivalency			Energy Savings
	MH	HPS	IND	
NRG4-30LU-4K-035-BZ	70w	70w	70w	65%
NRG4-30LU-4K-BZ	100w	100w	85w	53%
NRG4-30LU-5K-035-BZ	70w	70w	70w	65%
NRG4-30LU-5K-BZ	100w	100w	85w	53%

### DIMENSIONS

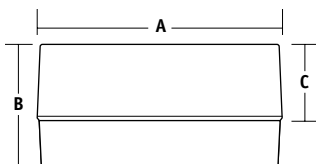

A	B	C	Weight
14" sq.	8 1/8"	4 3/4"	13.9 lbs.
356 mm	206 mm	121 mm	6.3 kg



**HUBBELL**  
Outdoor Lighting

# NRG<sup>®</sup> 400 Series

## Lumasquare<sup>®</sup> I Decorative Ceiling Series

CEILING/CANOPY/GARAGE



- Polycarbonate housing with molded-in dark bronze textured finish; Mounts directly to recessed junction boxes; "Hidden" latches secure refractor for tamper resistance and clean appearance; Shallow 5" depth
- Polycarbonate refractor minimizes side light while providing a uniform distribution from the bottom prisms; Excellent for low (7-10ft) mounting applications; HPS unit has hydroformed aluminum reflector, fluorescent reflectors are high gloss white to maximize lumens into the refractor
- Units provide a Type V distribution with good uniformity
- Available in 50w HPS, 2x13w PL-S and 2x28w PLC CFL – all units 120V and include lamp(s)
- Listed to UL1598 for damp locations indoor and outdoor



10-Day Quick Ship Ordering Guide  
Order Limit Per Fixture Selection: 15 – BC Pkg Code

Catalog Number <sup>1</sup>	Wattage	Voltage	Ballast Type	Min. Start Temp	Input Amps	Weight lbs. (kg)	PKG. CODE
NRG-401 <sup>1</sup>	50w HPS	120	Reactor	-40F	1.8	6 (2.7)	BC

### MADE-TO-ORDER ORDERING INFORMATION

Catalog Number <sup>1</sup>	Wattage	Voltage	Ballast Type	Min. Start Temp	Input Amps	Weight lbs. (kg)	PKG. CODE
NRG-406-2 <sup>1</sup>	2 x 13w CFL	120	Preheat	32F	.7	5 (2.3)	BC
NRG-456 <sup>1</sup>	2 x 28w CFL	120	NPF Reactor	-20F	1.2	6 (2.7)	BC

<sup>1</sup> CSA certified for outdoor applications only; UL indoor/ outdoor, NRG-406 uses GX23 base, NRG-456 uses GX32d-3 base lamps

Note: Lamp included

### STOCK

REPLACEMENT PART

Catalog Number	Description	PKG. CODE
264-0225-9904	Replacement refractor with molded hinges	BC

### ACCESSORIES - Order Separately

Catalog Number	Description
S-319-B	4" Cast aluminum round junction box for surface conduit mounting with two mounting lugs, four 1/2" tapped hubs, and three plugs; leaves fixture 2" from ceiling

S-319-B

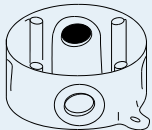

### DIMENSIONS

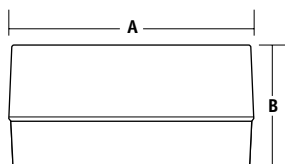

A	B
10" sq.	5"
254 mm	127 mm

# NRG® 4000 Series

## Lumasquare® II High Performance Canopy/Parking Garage Series

- Cast aluminum housing for rugged mounting and heat dissipation; Two 1/2" hubs for feed-through wiring standard; Three point lag to ceiling over recessed junction boxes is wet location listed when mounted to smooth surfaces
- Refractor is high temperature acrylic; Side prisms minimize side brightness while bottom prisms spread the light uniformly; Vertical H.I.D. lamp reduces intensity below the fixture and provides more lateral lumens for better project uniformity
- Reflector is hydroformed with fluted segments for excellent performance
- CFL version has a flat, high reflectance white reflector with horizontal lamps
- Standard finish is dark bronze powder paint; White (-WH) available as shown
- Lamp is included
- Listed to UL1598 for use in wet locations



CEILING/CANOPY/GARAGE



**10-Day Quick Ship Ordering Guide**  
Order Limit Per Fixture Selection: 15 – BC Pkg Code

Catalog Number	Mounting	Wattage	Voltage	Power Factor	Refractor	Weight lbs. (kg)	PKG. CODE
NRG-413P8 <sup>1</sup>	Ceiling/conduit	100w PSMH	Quad	HPF	High temp. acrylic	18 (8.2)	BC
NRG-415P8 <sup>1</sup>	Ceiling/conduit	150w PSMH	Quad	HPF	High temp. acrylic	19 (8.6)	BC

### MADE-TO-ORDER ORDERING INFORMATION

Catalog Number	Mounting	Wattage	Voltage	Power Factor	Refractor	Weight lbs. (kg)	PKG. CODE
NRG-413S8 <sup>1</sup>	Ceiling/conduit	100w HPS	Quad	HPF	High temp. acrylic	18 (8.2)	BC
NRG-414S8 <sup>1</sup>	Ceiling/conduit	150w HPS	Quad	HPF	High temp. acrylic	19 (8.6)	BC
NRG-413P8-WH <sup>1</sup> (white)	Ceiling/conduit	100w PSMH	Quad	HPF	High temp. acrylic	18 (8.2)	BC
NRG-415P8-WH <sup>1</sup> (white)	Ceiling/conduit	150w PSMH	Quad	HPF	High temp. acrylic	19 (8.6)	BC
NRG-484F8 <sup>2</sup>	Ceiling/Conduit	2x42w CFL	120-277	HPF	High temp. acrylic	15 (6.8)	BC

- 1 Includes medium base lamp  
2 Includes two 3500K, 4-PIN lamps, two ballast design allows independent lamp operation

### STOCK REPLACEMENT PART

Catalog Number	Description	PKG. CODE
800-3289-0100	Replacement refractor kit	BC

### DIMENSIONS

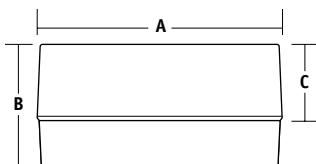

A	B	C
14" sq.	8 1/8"	4 3/4"
356 mm	206 mm	121 mm



**HUBBELL**  
Outdoor Lighting

# R9/R12 Series

## Round Vandal Resistant Ceiling/Wall Mount Units

HID/CFL CEILING

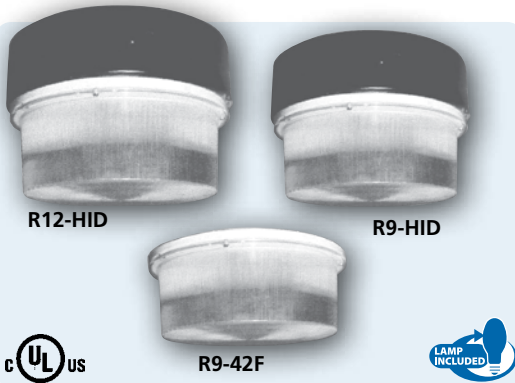

- Polycarbonate diffusers with center-pin torx tamper-proof hardware (driver bit included)
- Spun aluminum ballast enclosures with 1/2" knockouts
- Medium base and lamps are included
- CFL units are electronic with PLT lamps included (**no hubs, no upper housing, low profile**)
- All units are Quad-Tap®; CFL units are 50/60 Hz standard
- Units have dark bronze protective paint finish
- Listed to UL1598 for use in wet locations



### STOCK

### ORDERING INFORMATION

Catalog Number <sup>1</sup>	Wattage/ Source	Voltage <sup>2</sup>	Weight lbs. (kg)	PKG. CODE
<b>11 Inch Diameter</b>				
R9-70H	70w PSMH	Quad-Tap®	10 (4.5)	BC
R9-70S	70w HPS	Quad-Tap®	10 (4.5)	BC
<b>15 Inch Diameter</b>				
R12-100H	100w PSMH	Quad-Tap®	15 (6.8)	BC

1 Lamp included

2 Quad-Tap® - 120,208,240,277V

### MADE-TO-ORDER

### REPLACEMENT PARTS

Catalog Number	Description	PKG. CODE
SM020-LENS	Replacement lens only for R9 units	BC
SM021-LENS	Replacement lens only for R12 units	BC

### DIMENSIONS

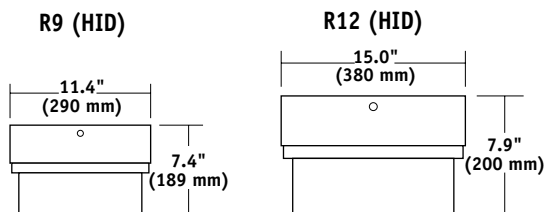



# S9/S12 Series

## Vandal Resistant Fixtures

- Die-cast aluminum housing with 1/2" conduit hubs on H.I.D. units; **CFL units have no top casting or hubs** – low profile, see dimensions below
- Vandal resistant prismatic polycarbonate refractor
- Bronze powder paint finish on H.I.D. units
- Medium base or CFL lamps included
- Typical mounting height ranges from 8 to 15 feet
- Listed to UL1598 for use in wet locations, wall or ceiling mount
- Center pin torx screws are standard (bit included)

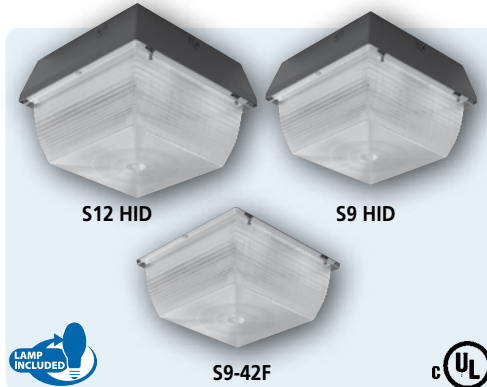

HID CEILING

### STOCK

### ORDERING INFORMATION

Catalog Number <sup>1</sup>	Wattage/ Source	Voltage	Finish	Weight lbs. (kg)	PKG. CODE
<b>Wet Location - Ceiling / Wall Mount</b>					
<b>Compact S9 – 9 inch Square</b>					
S9-42F*	42w CFL	120, 208, 240, 277	-	4 (1.8)	FCC
S9-70H	70w PSMH	120, 208, 240, 277	Bronze	10 (4.5)	FCC
<b>Mid-Size S12 – 12 inch Square</b>					
S12-100H	100w PSMH	120, 208, 240, 277	Bronze	15 (6.8)	FCC
S12-150P	150w PSMH	120, 208, 240, 277	Bronze	16 (7.3)	FCC

<sup>1</sup> Lamp included

\* Low profile, see photos and dimensions, no hubs or top housing, CFL lamps are 4-pin, 3500K

### MADE-TO-ORDER REPLACEMENT PARTS

Catalog Number	Description	PKG. CODE
SM009-LENS	Refractor only for S9 units	BC
SM012-LENS	Refractor only for S12 units	BC

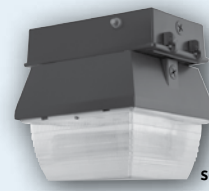

For CFL unit with battery backup for egress applications, see Dual-Lite PSG8 page 945

### DIMENSIONS

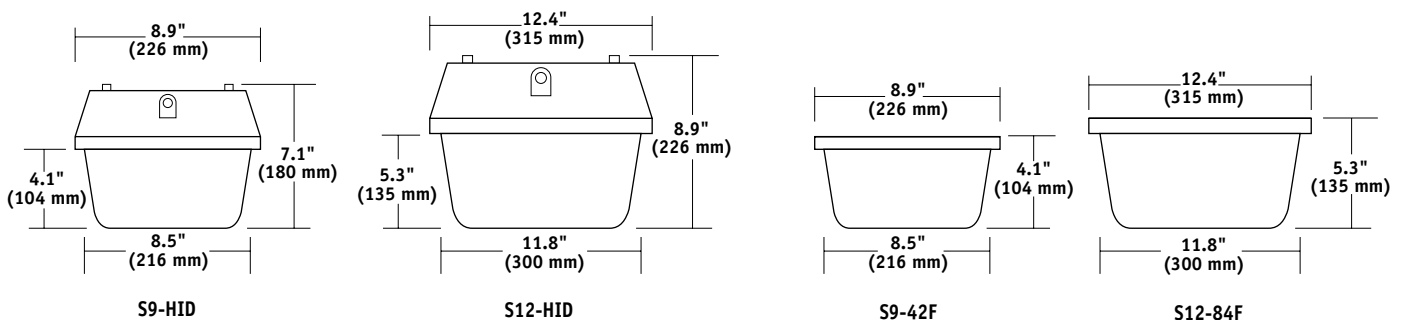

**HUBBELL**  
Outdoor Lighting

## RetroTrim System Canopy Lighting

HID CANOPY



- Modular design for flexibility, availability and value
- UCTs are used in conjunction with the UCL to retrofit an existing fixture
- White Lektrocote® powder paint for superior longevity
- Can reuse UCL for new installations
- Easy, cost effective installation
- Improved lighting with less energy
- U.S. Patent No. 6,182,848 and 6,276,818



### MADE-TO-ORDER ORDERING INFORMATION

Catalog Number	Description	PKG. CODE
<b>2 x 2 RetroTrims</b>		
<b>UCT-1</b>	Fixture size: 21 1/8" square; min. 6" above flange; flange opening range: 18 13/16" through 19 5/16"; Whiteway Riviera II/Thunderbird/Vision/LaSabre III; Cooper CLS	<b>BC</b>
<b>UCT-2</b>	Fixture Size: 23" square; min. 6" above flange; flange opening range: 20 13/16" through 21 9/32"; LSI Master/Dakota; Jet Phillips Houstonian (old style); Whiteway Riviera	<b>BC</b>
<b>UCT-3</b>	Fixture size: 21 3/4" square through 22" square; min. 6" above flange; flange opening range: 19 3/4" through 20 7/32"; Jet Phillips Houstonian SHO/RHO; Guardian MC-1411	<b>BC</b>
<b>Recessed RetroTrims</b>		
<b>UCT-4</b>	Fixture size: LSI Richmond Series 21 1/2" x 11 15/16" outside frame	<b>BC</b>
<b>UCT-5</b>	Fixture size: Whiteway Civic Series 20 3/4" x 11 1/16" outside frame	<b>BC</b>
<b>Surface Mount Housing Trims</b>		
<b>UCT-6</b>	16 1/4" square x 8" high surface mount housing trim; mounting hardware not included	<b>BC</b>
<b>Arm Mounted Housing Trims</b>		
<b>UCT-7</b>	16 1/4" square x 8" high arm mounted housing; order appropriate arm separately	<b>BC</b>
<b>International RetroTrims</b>		
<b>UCT-8</b>	Phillips MPF 211/212 recessed series: 520mm square frame	<b>BC</b>
<b>UCT-9</b>	Elsco Franciscan recessed or surface-mount series: 23 3/4" (603mm) square housing	<b>BC</b>

Note: Order UCL as shown on page 558, plus one UCT

Note: Due to our ongoing improvement program, specifications and design are subject to change without notice

### UCT Modular System

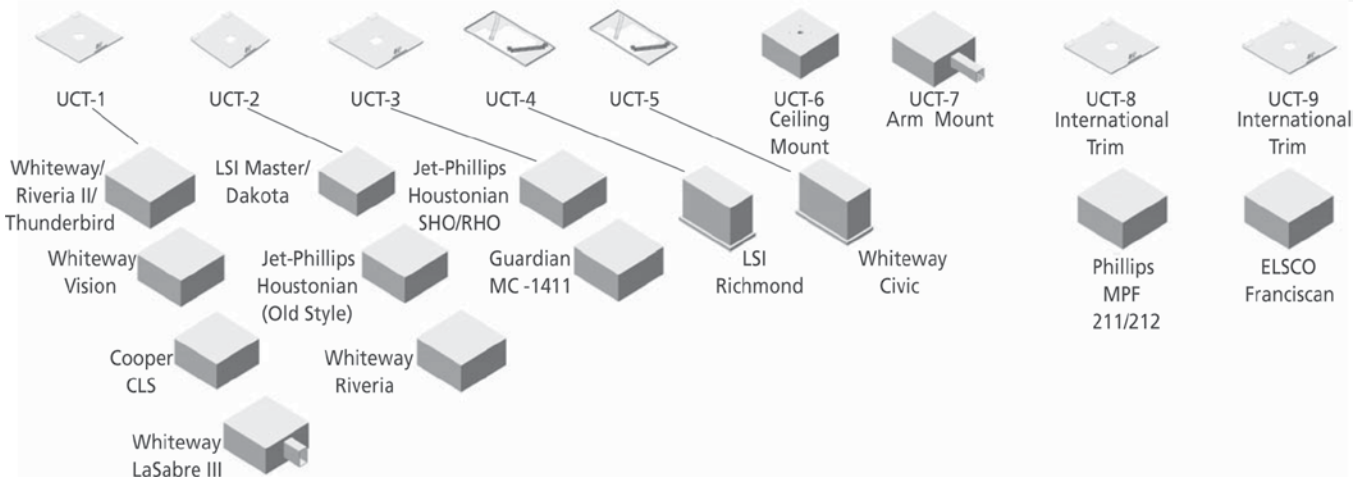

- Designed for roadway, parking, area and perimeter lighting; These versatile Roadway luminaires are designed to replace existing cobra-head style fixtures from 70-150w while saving up to 65% in energy; LED luminaires feature optimum uniformity, elimination of 'hot spots' and zero uplight
- 3800 lumens at 350 mA or 6700 lumens at 700 mA
- 30 LED light engine

- Standard IES distributions of Type II, III, IV, V with up to 95 LPW efficacy
- 120-277V, 347/480V electronic dimming drivers, 2 at 700 mA, 1 at 350 mA
- Die-cast aluminum housing
- Lektrocote® finish in 2 standard and custom colors
- DesignLights Consortium (DLC) qualified
- IP65 LED light engine assembly and drivers
- 10KA surge protector standard



### 10-Day Quick Ship Ordering Guide Order Limit Per Fixture Selection: 15 – BC Pkg Code

<b>RM</b>	-	<b>30L</b>	-	<b>U</b>	-		-		-		-	
SERIES		NUMBER OF LEDS		VOLTAGE		CCT		IES DISTRIBUTION		PHOTOCONTROL RECEPTACLE		FINISH
RM Zero uplight medium Roadway		30L 30 LEDs		U 120-277V		4K 4000K nominal, 70 CRI 5K 5000K nominal, 67 CRI		2 Type II 3 Type III 4 Type IV		2 None 3 Yes		GR Gray

### MADE-TO-ORDER ORDERING INFORMATION

<b>RM</b>	-	<b>30L</b>	-		-		-		-		-					
SERIES		NUMBER OF LEDS		VOLTAGE		CCT		IES DISTRIBUTION		DRIVE CURRENT		PHOTOCONTROL RECEPTACLE		OPTIONS		FINISH
RM Zero uplight medium Roadway		30L 30 LEDs		U 120-277V 5 480V F 347V		3K 3000K nominal, 80 CRI 4K 4000K nominal, 70 CRI 5K 5000K nominal, 67 CRI		2 Type II 3 Type III 4 Type IV 5M Type V		BLANK 700 mA 035 350 mA		2 None 3 Yes		F(X) Fusing, replace X with voltage, specify: 1-120V 2-208V 3-240V 4-277V 5-480V 6-347V BC <sup>1</sup> Back-light control		BK Black DB Dark Bronze CC Custom Color (Reference RAL#) GR Gray PS Platinum Silver WH White

1 Recommended for Type III and IV distributions only

### PERFORMANCE INFORMATION

Series Number	Equivalency		Delivered Lumens		Energy Savings	System Watts		LPW	CCT	Drivers/Current	PKG. CODE
	MH	HPS	Type 2	Type 3		120V-277V	347V-480V				
RM-30LU-3K	100w	100w	4612	4632	65%	70	70	65	3000K	2@700mA	BC
RM-30LU-4K	150w	100w	5844	5840	53%	70	70	83	4000K	2@700mA	BC
RM-30LU-5K	175w	150w	6712	6718	60%	70	70	95	5000K	2@700mA	BC

### DIMENSIONS



A	B	C	EPA	Weight
6.75"	13"	29.75"	0.6 ft. <sup>2</sup>	14.20 lbs.
171 mm	330 mm	756 mm	.05 m <sup>2</sup>	6.44 kg.



# RL LED

## Roadway

LED ROADWAY



- Designed for roadway, parking, area and perimeter lighting; These versatile Roadway luminaires replace existing cobra-head style fixtures from 200-400w while saving up to 56% in energy; LED luminaires feature optimum uniformity, elimination of 'hot spots' and zero uplight
- 12000 lumens at 700 mA
- Standard IES distributions of Type II, III, IV, V with up to 85 LPW efficacy
- Two 30 LED light engines
- 120-277V, 347/480V electronic dimming drivers (4) standard
- Die-cast aluminum housing
- Lektrocote® finish in 2 standard and custom colors
- IP65 LED light engine assembly and drivers
- 10KA surge protector standard



### 10-Day Quick Ship Ordering Guide Order Limit Per Fixture Selection: 15 – BC Pkg Code

<b>RL</b>	-	<b>60L</b>	-	<b>U</b>	-		-		-		-	
SERIES	NUMBER OF LEDES	VOLTAGE	CCT	IES DISTRIBUTION	PHOTOCONTROL RECEPTACLE	FINISH						
RL Zero uplight medium Roadway	60L 60 LEDs	U 120-277V	4K 4000K nominal, 70 CRI 5K 5000K nominal, 67 CRI	2 Type II 3 Type III 4 Type IV	2 None 3 Yes	GR Gray						

### MADE-TO-ORDER ORDERING INFORMATION

<b>RL</b>	-	<b>60L</b>	-		-		-		-		-	
SERIES	NUMBER OF LEDES	VOLTAGE	CCT	IES DISTRIBUTION	DRIVE CURRENT	PHOTOCONTROL RECEPTACLE	OPTIONS	FINISH				
RL Zero uplight large Roadway	60L 60 LEDs	U 120-277V 5 480V F 347V	3K 3000K nominal, 80 CRI 4K 4000K nominal, 70 CRI 5K 5000K nominal, 67 CRI	2 Type II 3 Type III 4 Type IV 5M Type V	BLANK 700 mA (141w)	2 None 3 Yes	F(X) Fusing, replace X with voltage, specify: 1-120V 2-208V 3-240V 4-277V 5-480V 6-347V BC <sup>1</sup> Back-light Control	BK Black DB Dark Bronze CC Custom Color (Reference RAL#) GR Gray PS Platinum Silver WH White				

1 Recommended for Type III and IV distributions only

### PERFORMANCE INFORMATION

Series Number	Equivalency		Delivered Lumens		Energy Savings	System Watts		LPW	CCT	Drivers/Current	PKG. CODE
	MH	HPS	Type 2	Type 3		120V-277V	347V-480V				
RL-60LU-3K	250w	200w	8833	8694	31%	141	141	63	3000K	4@700mA	BC
RL-60LU-4K	320w	250w	11044	11062	56%	141	141	79	4000K	4@700mA	BC
RL-60LU-5K	320w	250w	11759	12058	56%	141	141	85	5000K	4@700mA	BC

### DIMENSIONS

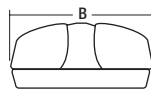
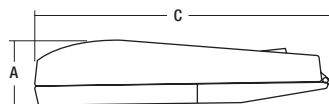

A	B	C	EPA	Weight
8.25"	15.75"	36.75"	1.0 ft. <sup>2</sup>	28 lbs.
210 mm	400 mm	933 mm	0.1 m <sup>2</sup>	12.7 kg.

# RL SERIES

## Standard Roadway Configurations

- Rugged die-cast aluminum with a two door design allowing maximum ease in installation and maintenance; This large size roadway fixture is designed for 250-400w lamps
- Flat tempered glass lens is cut-off design; A dense, self-filtering, felt gasket seals both optic systems with a screw and latch closure
- Horizontal lamp orientation with multi-faceted reflectors
- Pulse-rated mogul base porcelain sockets with nickel-plated center contacts
- Quad-Tap® or 480V ballastry, HPF, with quick connect to housing power door; Photoelectric receptacle standard; HPS-auto lag (70, 100, 150w), auto regulator (250, 400w)/ pulse start metal halide auto transformer; Suitable for wet locations
- 4 bolt slip fitter mounting, adjustable for 1 1/4" - 2" pipe, +/- horizontal adjustment for leveling



HID ROADWAY

### MADE-TO-ORDER ORDERING INFORMATION

Catalog Number	Description	EPA	Ballast Type	Weight		PKG. CODE
				lbs.	kgs.	
<b>Fixture Housings: Breathing Felt Gasket Optical Seal, with Photocell Receptacle<sup>2</sup>, Type III Distribution</b>						
RLC-3-1	Full cut-off, III med, Bronze	1.0	-	19	8.6	BC
RLC-3-3	Full cut-off, III med, Gray	1.0	-	19	8.6	BC
<b>Ballast Doors: Screw and Latch Closure, HPF ballast, ANSI label, UL Listed<sup>3</sup></b>						
RLD-25S38-1	250 HPS Quad, Bronze		Auto Reg	17	7.7	BC
RLD-25S35-1	250 HPS 480V, Bronze		Auto Reg	17	7.7	BC
RLD-25S38-3	250 HPS Quad, Gray		Auto Reg	17	7.7	BC
RLD-25S35-3	250 HPS 480V, Gray		Auto Reg	17	7.7	BC
RLD-40S38-1	400 HPS Quad, Bronze		Auto Reg	19	8.6	BC
RLD-40S35-1	400 HPS 480V, Bronze		Auto Reg	19	8.6	BC
RLD-40S38-3	400 HPS Quad, Gray		Auto Reg	19	8.6	BC
RLD-40S35-3	400 HPS 480V, Gray		Auto Reg	19	8.6	BC
RLD-40P38-1 <sup>1</sup>	400 PSMH Quad, Bronze		PLA	18	8.2	BC
RLD-40P35-1 <sup>1</sup>	400 PSMH 480V, Bronze		PLA	18	8.2	BC
RLD-40P38-3 <sup>1</sup>	400 PSMH Quad, Gray		PLA	18	8.2	BC
RLD-40P35-3 <sup>1</sup>	400 PSMH 480V, Gray		PLA	18	8.2	BC

1 When used with RLC (cut-off) housings, must use PS ED-28 size lamps; Standard ED-37 lamps may be used with RLG housings

2 PSCPhotocontrol shorting cap (see pg. 517) ordered separately

3 Ballast doors are available in Tri-Tap with 347 volt, change 8 to 6

### RM/RL DIMENSIONS

	A	B	C	D
RLC	8 1/4" (210 mm)	15 3/4" (400 mm)	36 3/4" (933 mm)	-
RMC	6 1/2" (165 mm)	13" (330 mm)	29 3/4" (756 mm)	-
RLG	-	15 3/4" (400 mm)	36 3/4" (933 mm)	14 3/4" (375 mm)

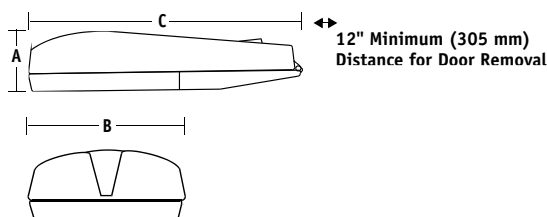

RLC/RMC Housings



**HUBBELL**  
Outdoor Lighting

# RM Series

## Standard Roadway Configurations

HID ROADWAY



- Rugged die-cast aluminum with a two door design allowing maximum ease in installation and maintenance; This medium size roadway fixture is designed for 70-250w lamps
- Prismatic refractor (glass and acrylic) or flat tempered glass lens allows a choice of refractor or cut-off designs; A dense, self-filtering, felt gasket seals both optic systems with a screw and latch closure
- Horizontal lamp orientation with multi-faceted reflectors on cut-off designs for a no-glare unit; Refractor units feature horizontal lamps as well; Type III distribution, field adjustable to Type II
- Mogul base pulse-rated porcelain sockets with nickel-plated center contacts
- Quad-Tap® or 480V ballast, HPF, with quick connect to housing power door; Photoelectric receptacle standard. HPS-auto lag (70, 100, 150w), auto regulator (250w), PSMH auto transformer; Suitable for wet locations
- 4 bolt slip fitter mounting, adjustable for 1 1/4" - 2" pipe, +/- horizontal adjustment for leveling



### MADE-TO-ORDER ORDERING INFORMATION

Catalog Number	Description	EPA	Ballast Type	Weight		PKG. CODE
				lbs.	kgs.	
<b>Fixture Housings: Breathing Felt Gasket Optical Seal, with Photocell Receptacle<sup>2</sup> Type III Distribution</b>						
RMC-3-1	Full cut-off, III med, Bronze	0.6	-	14	6.4	BC
RMC-3-3	Full cut-off, III med, Gray	0.6	-	14	6.4	BC
RMA-3-1 <sup>1</sup>	Acrylic refractor, Semi-cut-off III med, Bronze	0.6	-	14	6.4	BC
RMA-3-3 <sup>1</sup>	Acrylic refractor, Semi-cut-off III med, Gray	0.6	-	14	6.4	BC
RMG-3-1	Glass refractor, Non-cut-off III med, Bronze	0.6	-	16	7.3	BC
RMG-3-3	Glass refractor, Non-cut-off III med, Gray	0.6	-	16	7.3	BC
<b>Ballast Doors: Screw and Latch Closure, HPF ballast, ANSI label, UL Listed<sup>3</sup></b>						
RMD-07S28-1	70 HPS Quad-Tap® V, Bronze		Auto Lag	5	2.3	BC
RMD-07S25-1	70 HPS 480V, Bronze		Auto Lag	5	2.3	BC
RMD-07S28-3	70 HPS Quad-Tap® V, Gray		Auto Lag	5	2.3	BC
RMD-07S25-3	70 HPS 480V, Gray		Auto Lag	5	2.3	BC
RMD-10S28-1	100HPS Quad-Tap®, Bronze		Auto Lag	6	2.7	BC
RMD-10S25-1	100HPS 480V, Bronze		Auto Lag	6	2.7	BC
RMD-10S28-3	100HPS Quad-Tap®, Gray		Auto Lag	6	2.7	BC
RMD-10S25-3	100HPS 480V, Gray		Auto Lag	6	2.7	BC
RMD-15S28-1	150HPS Quad-Tap®, Bronze		Auto Lag	7	3.2	BC
RMD-15S25-1	150HPS 480V, Bronze		Auto Lag	7	3.2	BC
RMD-15S28-3	150HPS Quad-Tap®, Gray		Auto Lag	7	3.2	BC
RMD-15S25-3	150HPS 480V, Gray		Auto Lag	7	3.2	BC
RMD-25S38-1	250HPS Quad-Tap® Bronze		Auto Reg	14	6.4	BC
RMD-25S35-1	250HPS 480V, Bronze		Auto Reg	14	6.4	BC
RMD-25S38-3	250HPS Quad-Tap®, Gray		Auto Reg	14	6.4	BC
RMD-25S35-3	250HPS 480V, Gray		Auto Reg	14	6.4	BC
RMD-15P38-1	150PSMH Quad-Tap®, Bronze		PLA	7	3.2	BC
RMD-15P35-1	150PSMH 480V, Bronze		PLA	7	3.2	BC
RMD-15P38-3	150PSMH Quad-Tap®, Gray		PLA	7	3.2	BC
RMD-15P35-3	150PSMH 480V, Gray		PLA	7	3.2	BC
RMD-25P38-1	250PSMH Quad-Tap®, Bronze		PLA	9	4.1	BC
RMD-25P35-1	250PSMH 480V, Bronze		PLA	9	4.1	BC
RMD-25P38-3	250PSMH Quad-Tap®, Gray		PLA	9	4.1	BC
RMD-25P35-3	250PSMH 480V, Gray		PLA	9	4.1	BC

1 150w maximum  
 2 PSCPhotocontrol shorting cap (see pg. 517) ordered separately  
 3 Ballast doors are available in Tri-Tap with 347V, change 8 to 6





# Mounting Brackets

## Square Steel Pole Mounting Brackets

The ARM and RA brackets are made from 2 3/8" OD steel tubing and are designed to mount on square steel poles (SSS Series). Units are offered in gray or dark bronze powder paint finishes to match our RM/RL roadway series. Brackets are the #6 drilling pattern on Hubbell / Spaulding poles. Mounting hardware for those poles is included.

### STOCK ORDERING INFORMATION

Catalog Number	Length (ft)	OD	Finish	EPA	Weight lbs (kg)	PKG. CODE
RA-6P-M53-W	72"	2 3/8"	Gray	1.2	20 (9.1)	BC

### MADE-TO-ORDER ORDERING INFORMATION

Catalog Number	Length (ft)	OD	Finish	EPA	Weight lbs (kg)	PKG. CODE
ARM-16-1	21"	2 3/8"	Bronze	0.18	8 (3.7)	BC
ARM-16-3	21"	2 3/8"	Gray	0.18	8 (3.7)	BC
RA-4P-M51-W	48"	2 3/8"	Bronze	1.0	16 (7.3)	BC
RA-4P-M53-W	48"	2 3/8"	Gray	1.0	16 (7.3)	BC
RA-6P-M51-W	72"	2 3/8"	Bronze	1.2	20 (9.1)	BC

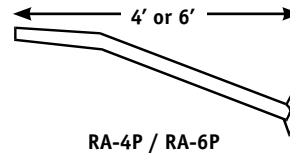
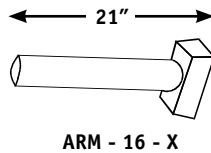

## Wood Pole Mounting Brackets

This section of aluminum and galvanized steel utility wood pole brackets provides a range of mounting capabilities. 1 1/4" pipe arms can be used with RM roadway units or DD dusk-to-dawns. The 2" pipe arms (2 3/8" OD) are perfect for RL or RM roadway units. Mounting hardware is not included and mounting holes vary slightly from bracket to bracket. Select hardware after your brackets arrive and in relation to the specific pole diameter on which it is to be mounted.

### MADE-TO-ORDER ORDERING INFORMATION

Catalog Number	Dimensions (inches)			OD	Weight		PKG. CODE
	(C)	(B)	(A)		lbs	Kg	
<b>Aluminum</b>							
WB-01A	10"	19"	42"	1 1/4"	4	1.8	BC
WB-04A	10"	19"	42"	2"	7	3.2	BC
WB-05A	12"	24"	66"	2"	10	4.5	BC
WB-07A	15"	30"	90"	2"	16	7.3	BC
<b>Galvanized Steel</b>							
WB-02S	10"	15"	30"	1 1/4"	9	4.1	BC
WB-03S	10"	19"	42"	1 1/4"	11	5	BC
WB-04S	12"	24"	66"	1 1/4"	15	6.8	BC
WB-06S	10"	19"	42"	2"	18	8.2	BC
WB-07S	12"	24"	66"	2"	24	10.9	BC
WB-08S	15"	30"	90"	2"	30	13.6	BC

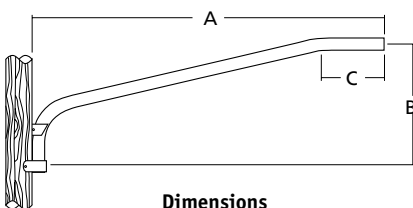

# DDL Dusk-to-Dawn

## Multi-purpose LED Luminaire

LED DUSK-TO-DAWN

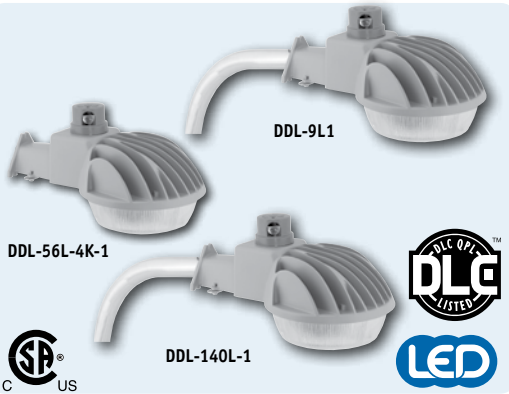

- Rugged die-cast aluminum housing with both 2-3/8" & 1-5/8" OD mast arm mount capability as well as direct wall/surface mounting
- Zero uplight design for environmentally friendly installations
- Refractor accessory (order separately) provides enhanced security lighting and LED brightness control when installed (Does not comply with DLC 0% up light requirement with refractor installed)
- Three models from 2900-5200 lumens, 30-43.5w, up to 121 LPW efficacy
- Symmetric lens installed standard
- Prismatic acrylic refractor included for security applications and glare control
- DDL-9L only: Field rotatable asymmetric lens included – for pathway/ roadway application
- 120V operation
- 120V twist-lock style photocontrol included
- Textured gray powder paint finish
- 24" (18" projection) arm included for DDL-9L and DDL-140L only, arm not included for DDL-56L
- ANSI 3G Rated
- Listed to UL1598 for use in wet locations
- All models are DesignLights Consortium qualified

### STOCK ORDERING INFORMATION

Catalog Number	Mounting Height	Mount	Wattage	# of Drivers/ Current	Voltage	Color Temperature	Delivered Lumens	LPW	Weight lbs. (kg)	PKG. CODE
DDL-9L1	up to 20 ft.	Arm/Wall/Surface	40	1@1280mA	120V	5000K	3437	86	6.8 (3.08)	FCC
DDL-56L-4K-1-NA	up to 15 ft.	Wall/Arm (not included)	30	1@150mA	120V	4000K	2906	97	6.8 (3.08)	SCC
DDL-140L-1	up to 25 ft.	Wall/Arm included	43.5	1@92mA	120V	5000K	5279	121	6.8 (3.08)	SCC

### PERFORMANCE INFORMATION

Series Number	Equivalency			Energy Savings
	MH	HPS	CFL	
DDL-9L1 (Symmetric lens)	100w	100w	85w	60%
DDL-9L1 (Asymmetric lens)	100w	100w	85w	60%
DDL-56L-4K-1-NA	100w	100w	85w	70%
DDL-140L-1	175w	150w	125w	71%

### STOCK ACCESSORIES/REPLACEMENT PARTS - Order Separately

Catalog Number	Description
ARM-DD24	24" aluminum arm with hardware
ARM-DD30	30" aluminum arm with hardware
DDL-DRIVER-120V	Driver for DDL9L (120V)
DDL-DRIVER-140	Diver for DDL-140L (120V)
DDL-DRIVER-56	Driver for DDL-56L (120V)
DDL-LENS-140	LED Asymmetric lens for DDL-140L
DDL-LENS2	LED Asymmetric lens for DDL-9L
DDL-LENS5	LED Symmetric lens for DDL-9L or DDL-56L
DDL-REFR	Refractor for all DDL models

### DIMENSIONS

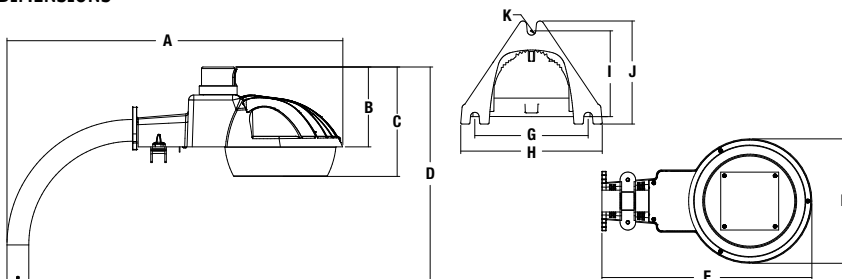

A	B	C	D	E	F	G	H	I	J	K
29.7"	6" or 4"	8.3"	16.2"	9.5"	16"	3.6"	4.5"	2.7"	3.3"	.14"
754 mm	152 mm	209 mm	411 mm	240 mm	406 mm	92 mm	115 mm	69 mm	84 mm	3.5mm

B Dimension = 4" without photocontrol



# DDL Utility Dusk-to-Dawn

## Multi-purpose LED Utility Luminaire

- Utility grade design and performance
- 8' long supply leads
- Refractor is installed and provides enhanced security lighting and LED brightness control
- Removal of refractor provides zero uplight for environmentally friendly installations
- 40w system with up to 3437 lumens and 86 LPW
- Symmetric lens installed standard
- 120V operation
- Rugged die-cast aluminum housing with both 2-3/8" & 1-5/8" OD mast arm mount capability as well as direct wall/ surface mounting
- Textured gray powder paint finish
- ANSI 3G Rated
- Listed to UL1598 for use in wet locations



LED DUSK-TO-DAWN

### MADE-TO-ORDER ORDERING INFORMATION

Catalog Number	Construction	Mount	Wattage	# Drivers/ Current	Voltage	Color Temperature	Lumens	LPW	Weight lbs. (kg)	PKG. CODE
DDL9L1NANPC8C	Die-cast aluminum	up to 20 ft.	40	1@1280mA	120V	5000K	3437	86	6.8 (3.08)	BC

### STOCK ACCESSORIES/REPLACEMENT PARTS - Order Separately

Catalog Number	Description
DDL-DRIVER-120V	Driver for DDL9L (120V)
DDL-LENS2	LED Asymmetric lens for DDL-9L
DDL-LENS5	LED Symmetric lens for DDL-9L
DDL-REFR	Refractor for DDL-9L
ARM-DD24	24" aluminum arm with hardware
ARM-DD30	30" aluminum arm with hardware
DDL-LENS	LED Asymmetric lens for DDL-9L

### OPTIONAL FEATURES - Consult Factory

Item	Description
Replacement Driver	120V-277V Driver
Photocell	120V-277V Photocell
Surge Protector	10KV/10KA Surge Protector

### DIMENSIONS

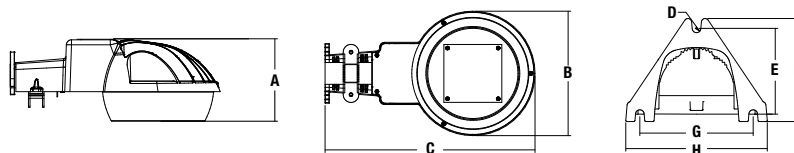

A	B	C	D	E	F	G	H
4"	9.5"	16"	.14"	2.7"	3.3"	3.6"	4.5"
152 mm	240 mm	406 mm	3.5 mm	69 mm	84 mm	92 mm	115 mm



**HUBBELL**  
Outdoor Lighting

# DD Series

## Dusk-To-Dawn

HID DUSK-TO-DAWN

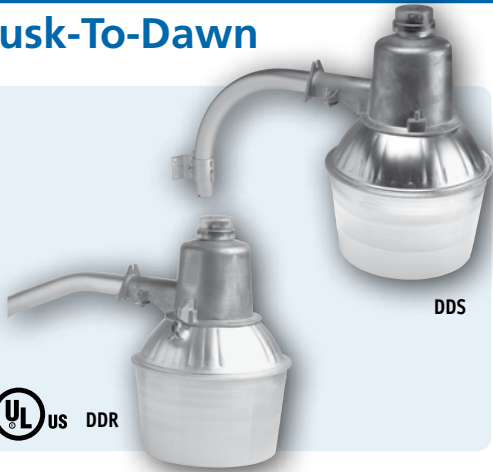

DDS



- The DD Series offers HID and CFL energy savings and safety/security lighting
- The Type V acrylic refractor provides wide, uniform coverage
- Units are designed in distributor or utility versions, see listings below
- Kits include 1 1/4" pipe arm, lamp, 120V photocontrol and mounting hardware, except for DD-70S, which is wall mount as shown
- PSMH and CFL units offer "white" light option; CFL unit is recommended for use in warmer climates; Minimum starting for CFL is 0°F; Nominal light output is at 77°F ambient
- Distributor kits are listed to UL1598 for use in wet locations (utility versions not listed)

### STOCK ORDERING INFORMATION

Catalog Number	Wattage	Source	Optic Dia.	Lamp	Weight lbs. (kg)	PKG. CODE
<b>Distributor kits - 24" curved aluminum arm, UL listed. Screw-on optics</b>						
<b>High Pressure Sodium</b>						
DDS-100S	100	HPS	12"	Med. Clear	4.5 (2.0)	FCC
DDS-150S	150	HPS	12"	Med. Clear	5.0 (2.3)	FCC
<b>Pulse Start Metal Halide</b>						
DDS-100P	100	PSMH	12"	Med. Clear	6.0 (2.7)	FCC
DDS-100PL	100	PSMH	12" with latches	Med. Clear	6.0 (2.7)	BC
<b>Compact Fluorescent</b>						
DDS-65F	65	CFL	12"	Med. Screw Base	4.0 (1.8)	FCC
<b>Utility kits - 24" curved aluminum arm, terminal block, 60" leads, latch-on optics</b>						
DDR100S	100	HPS	12"	Mogul Clear	6.5 (2.9)	BC
DDR150S	150	HPS	12"	Mogul Clear	6.5 (2.9)	BC

### STOCK REPLACEMENT PARTS

Catalog Number	Description	Weight lbs. (kg)	PKG. CODE
DDR-5AP	Replacement optics, latch-on, Type V acrylic for DDR fixtures	1.5 (0.7)	BC
PTL-1	Replacement 120V twist lock photocontrol	0.1 (0.05)	BC
93023491	Replacement 65w CF lamp	5 (2.25)	BC

### DIMENSIONS

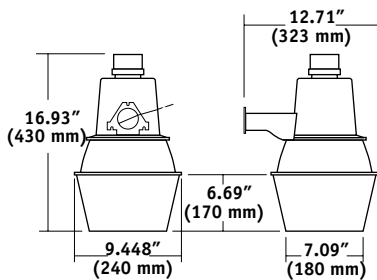

DD

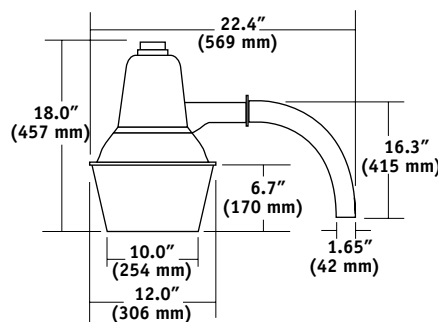

DDS

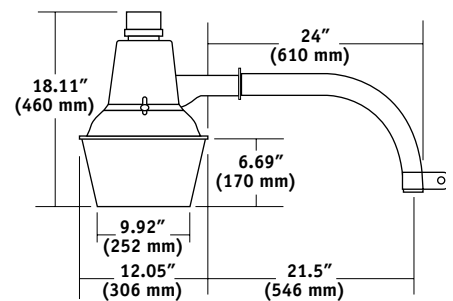

DDR



# VBGL/VWGL

## Wet Location LED Vaportites

- Compact size measuring only 5.2" x 10.4" (wall mount version slightly larger)
- 757 lumens, 11w system, 70 LPW
- Frosted glass lens distributes symmetric light evenly without any LED brightness or glare
- Pendant mount version accommodates traditional 1/2" x 14 NPS threaded conduit
- 120-277V operation, 50/60Hz
- Rugged die-cast aluminum housing with removable cast aluminum guard with vandal resistant set screws included, gray finish
- IP66, listed to UL1598 for use in wet locations (unit is not rated for use in hazardous locations)
- Four color multi-language merchandising carton with application details

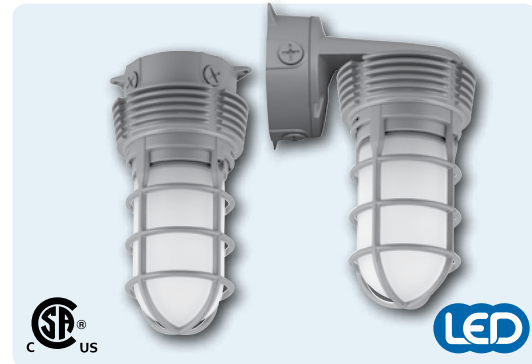

INCANDESCENT VAPORTITES

### STOCK ORDERING INFORMATION

Catalog Number	Construction	Mount	System Wattage	# Drivers/Current	Voltage	Color Temperature	Lumens	LPW	Weight lbs. (kg)	PKG. CODE
<b>VBGL-1</b>	Globe refractor	Ceiling/Pendant	11	1@250mA	120-277V	4000K	757	70	3.4 (1.54)	FCC
<b>VWGL-1</b>	Globe refractor	Wall	11	1@250mA	120-277V	4000K	757	70	3.6 (1.63)	FCC

### PERFORMANCE INFORMATION

Series Number	Equivalency		Energy Savings
	INC	CFL	
<b>VBGL-1</b>	150w	32w	88%
<b>VWGL-1</b>	150w	32w	88%

### STOCK REPLACEMENT GLOBES

Catalog Number	Description	PKG. CODE
<b>VGL-FG</b>	Frosted globe	BC
<b>VGL-GUARD</b>	Guard with set screws	BC
Colored Globes		PKG. CODE
<b>VGL-GN</b>	Green globe	BC
<b>VGL-YW</b>	Yellow globe	BC
<b>VGL-BU</b>	Blue globe	BC
<b>VGL-RD</b>	Red globe	BC

### DIMENSIONS

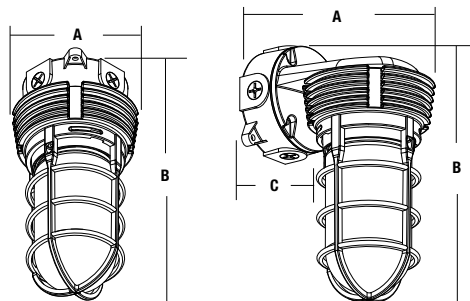

	A	B	C
<b>VBGL-1</b>	5.2" 132 mm	10.4" 263 mm	-
<b>VWGL-1</b>	7.3" 186 mm	11.0" 280 mm	5.2" 132 mm



**HUBBELL**  
Outdoor Lighting

# VBGG/VWGG Series

## Wet Location Vaportites

INCANDESCENT VAPORTITES



- Wall/ceiling/pendant entry, corridor, tunnel, service area, stairwell, or retro-accent
- 150w/300w maximum medium base incandescent
- Platinum silver protective finish
- VWGG has cast aluminum wall bracket with cast wiring box; Box has external lugs and four side 1/2" hubs for surface conduit and one rear 1/2" access hub
- VBGG has cast aluminum wiring box with external lugs for ceiling mount and four 1/2" hubs for surface conduit;

Wiring box has top 1/2" hub for pendant mount

- All units have water/bug tight gasketing
- All units have medium base porcelain socket
- All units include clear glass protective globe with thread-on cast aluminum guard; Guard includes vandal-resistant set screw
- All units are UL listed for use in wet locations

### STOCK ORDERING INFORMATION

Catalog Number	Wattage	Mounting	Weight lbs. (kg)	PKG. CODE
VBGG-150	150	Box/pendant	3 (1.36)	FCC
VWGG-150	150	Wall	3.5 (1.59)	FCC

### STOCK REPLACEMENT GLOBES

Catalog Number	Description	PKG. CODE
VRGP-100	Ruby, tempered	BC

### MADE-TO-ORDER REPLACEMENT GLOBES

Catalog Number	Description	PKG. CODE
VAMG-100	Amber	BC
VBG-100	Blue	BC
VBGP-100	Blue, tempered	BC
VCGP-100	Clear, tempered	BC
VCGPT-100	Clear, tempered w/ Tuffskin® coating	BC
VGG-100	Blue Green	BC
VGGP-100	Blue Green, tempered	BC
VPG-100	Purple	BC
VRG-100	Ruby	BC
VRSG-100	Green	BC
VCGP-200	Clear, Tempered	BC
VAMG-200	Amber	BC
VGG-200	Blue Green	BC
VGGP-200	Blue Green, tempered	BC
VRG-200	Ruby	BC

### DIMENSIONS

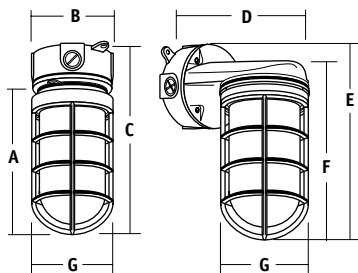

150w

Lugs: 5" center to center

	A	B	C	D	E	F	G
150w	7"	1 1/2"	9"	7 1/4"	9 3/4"	8 1/2"	4"
	178 mm	38 mm	229 mm	184 mm	248 mm	216 mm	102 mm





# 12V LED Lightscaper® System

Long Life, Easy to Install, No Maintenance Lighting System

- LED landscape fixtures, long life, low energy consumption, no maintenance, three-year limited warranty
- Die-cast aluminum construction, professional grade, built to perform with durable design
- Powder coat polyester epoxy finish maintains lasting beauty
- 1.5w path fixtures in 7 styles; 3w flood and recessed uplight; 3000K CCT
- Path and flood fixtures are complete with stake, 4' fixture cable, and "Smart Connect" tool-free connector; Flat surface deck adapter included
- Control center is UL listed for wet locations and features non-metallic housing, grounded cord set, photocontrol, and easy cable connect

A simple system, easy to install and maintain, with low energy consumption for safety, security and property enhancement. Go Green with Hubbell Lightscaper® LED products!



LED LANDSCAPE

## STOCK ORDERING INFORMATION

Catalog Number	Finish	Description	Weight	PKG. CODE
<b>CONE</b>				
CO-AB	Antique Bronze	Create a tropical image. The basic 7" dia. cone shape sits 15" high and creates a 5' lighted area with soft, indirect shielded light. Excellent for subtle illumination of plants or walkways.	2.0 lbs	FCC
CO-AG	Antique Green			
<b>GREENVILLE</b>				
GN-AB	Antique Bronze	A stately appearance with classic shape. Stands 16" tall with 5" dia. head. Frosted lens provides soft lighting of taller surrounding plantings with 5' coverage. Use along walkways, steps. Typical spacing 8'-12'.	2.75 lbs	FCC
GN-PT	Pewter			
<b>REIDVILLE</b>				
RD-AB	Antique Bronze	Bell-shaped head supported by decorative arm and sturdy staff. Full cut-off pattern provides 5' light pool on ground with no glare. Perfect for highlighting walkways, flowers and specimen plants. Typical spacing 8'-10'.	3.25 lbs	FCC
<b>EYELID</b>				
EL-AB	Antique Bronze	Round eyelid for deck post or steplighting. Can be surface mounted or semi-recessed. Use for accent or small area illumination of perimeters or stairways. 2' mounting height provides soft coverage 5' w, 2' forward. 6' fixture cable.	1.0 lbs	FCC
EL-PT	Pewter			
<b>RECESSED</b>				
RE-PT	Pewter	Round recessed uplight for accent lighting of trees, columns and building facades. Powerful 3w LED projection beam. Provides hidden light source.	1.5 lbs	FCC
<b>FLOODLIGHT</b>				
FL-AB	Antique Bronze	Powerful 3w LED projection flood with adjustable knuckle for versatile aiming. Use for accent lighting of building facades, small signs or address numbers, columns, trees and residential flags to 20'.	2.0 lbs	FCC
<b>CONTROL CENTER</b>				
LVT56	Black	Non-metallic case protects timer controls and 120V to 12V transformer. Surge protected with grounded cord/plug set and easy 12V cable attachment. Photocontrol triggers "time on", eliminating seasonal adjustment. UL and cETL certified. 56w capacity.	4.0 lbs	FCC
<b>CABLE</b>				
CB-75	Black	Low voltage #14 cable runs from LVT56 transformer down path of lighting. UV protected, burial is not required, hide with mulch if desired. Perfect fit with fixture connectors for easy installation (150' is the max. run distance from transformer location to assure best fixture operation).	4.0 lbs	FCC
CB-150	Black		6.0 lbs	FCC

NOTE: All fixtures are complete with LED light engine, 4' minimum fixture cable and "Smart Connect" tool-free connector. Path lights and floods also include ground stake and a deck mount adapter for flat surfaces. When you purchase Lightscaper®, you get it all!

# Lightscaper® Fixtures

12V LED

LED LANDSCAPE

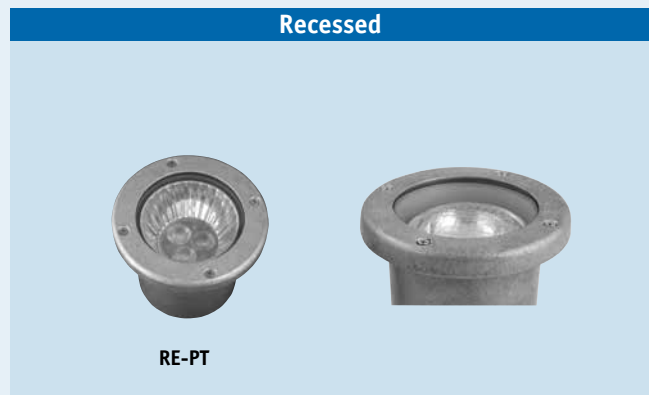
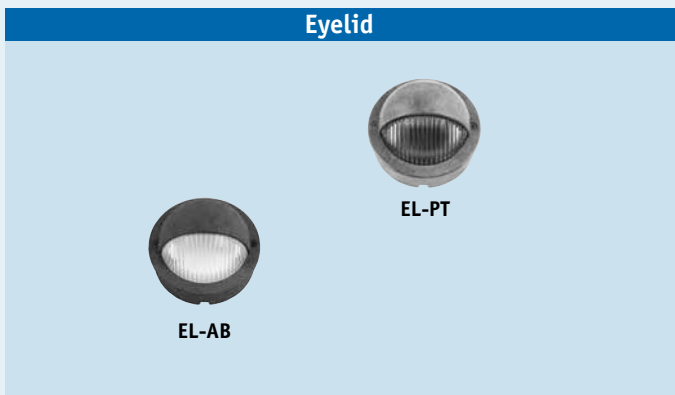

**DIMENSIONS**

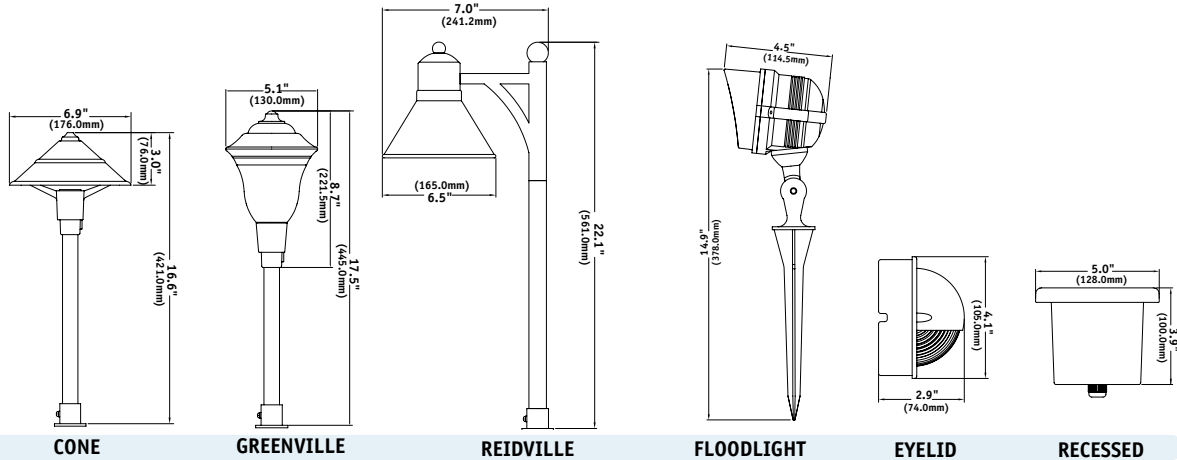

**HUBBELL**  
Outdoor Lighting

# Lightscaper®

## 120V Louverlights

- Use for landscape lighting in flower beds, along paths, sidewalks and steps. Accent and safety illumination.
- 583-G Non-metallic louverlight is incandescent for use with lamps up to 60watts. Molded-in Shalida green finish for lasting appearance and corrosion resistance. Ribbed glass globe shields lamp image and spreads light. Three steel screws secure cap and louvers to base. 1/2" female threads for mounting. CSA certified to UL1598 for ground mount in wet locations.
- All units are 120V
- Listed to UL1598 for use in wet locations

583-G

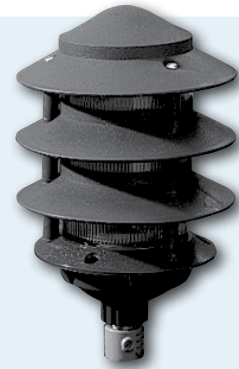

LANDSCAPE

### MADE-TO-ORDER ORDERING INFORMATION

Catalog Number	Description	Weight lbs. (kg)	PKG. CODE
<b>Three Tier</b>			
<b>583-G</b>	Fixture with three louvers; Green finish; 60w inc max.	2 (0.9)	<b>BC</b>

Note: For accessories, see Landscape Accessories (page 565)

### DIMENSIONS

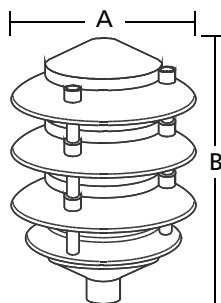

A	B
6 1/2"	8 1/2"
165 mm	216 mm



**HUBBELL**  
Outdoor Lighting

# 103/103-7/306 Series

## PAR Lampholders

LAMP HOLDERS



### 103 LAMPHOLDER

- Full size lampholder with rugged construction. Large 1/2" swivel knuckle adds strength and allows universal aiming; Silicone gasket seals to PAR lamps for water-tight design; 150w max. Natural aluminum finish; Porcelain medium base socket; Listed to UL1598 for use in wet locations

### 103-7 SERIES

- Shielded lampholder for use with PAR lamps to 150w max; "Bell" shape has traditional styling; porcelain medium base socket; 1/2" cast aluminum swivel knuckle allows universal aiming; Various finishes available - gray, bronze, black, white, Shalda green; Listed to UL1598 for use in wet locations

### 306 SERIES

- Die-cast housing and door available in Gray powder paint protective finish with tempered glass lens with silicone gasket; PAR 56 lamps - 300w incandescent or 500w quartz (by others); Listed to UL1598 for use in wet locations



### STOCK

### ORDERING INFORMATION

103

Catalog Number	Description	Gasket	Finish	Weight lbs. (kg)	PKG. CODE
103	Unshielded, full size	Silicone	Natural Aluminum	.75 (.3)	BC

103-7 Series

Catalog Number	Description	Gasket	Finish	Weight lbs. (kg)	PKG. CODE
103-7	Shielded, bell shape	Silicone	Gray	1.25 (0.6)	FCC
103-71	Shielded, bell shape	Silicone	Bronze	1.25 (0.6)	BC
103-72	Shielded, bell shape	Silicone	Black	1.25 (0.6)	BC

306

Catalog Number	Description	Finish	Weight lbs. (kg)	PKG. CODE
306	1/2" Swivel knuckle mount, 12" leads, hinged door and lens	Gray	3.375 (1.7)	BC

Note PAR 56 lampholders for 300w (maximum) incandescent or 500w quartz; Lamp not included

### STOCK

### REPLACEMENT PARTS

Catalog Number	Description	PKG. CODE
207-5011-0264	Bronze knuckle	BC
S-329-B	4" Round wet location outlet box with cover - 1/2" hubs	BC

### MADE-TO-ORDER

### ACCESSORIES - Order Separately

Catalog Number	Description	PKG. CODE
1306C	Lens & Gasket	BC
S-307	Wire guard for PAR and R lamps, for use with 103 fixture	BC
1324	Wire guard for PAR lamps, for use with 103-7 Series	BC
1308	Plated wire guard for 306 (0.2lbs (.09kg))	BC
1031-3	Ground spike with splice box and 6' cord set - 1/2" top hub	BC

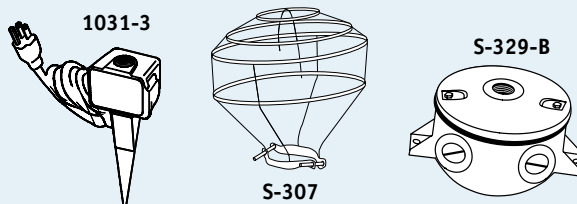

### DIMENSIONS

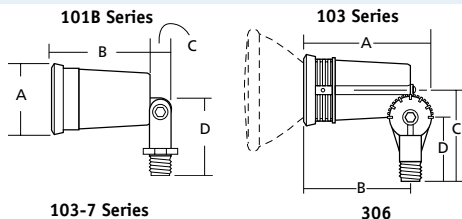

	A	B	C	D	E
101B	2 1/2"	3"	0.5"	1.5"	-
	55 mm	76 mm	13 mm	38 mm	-
103	4 13/16"	4"	3 7/16"	2 3/8"	-
	122 mm	102 mm	87 mm	60 mm	-
103-7	1 5/16"	6"	5 3/8"	4 1/16"	3 7/16"
	33 mm	152 mm	137 mm	103 mm	87 mm

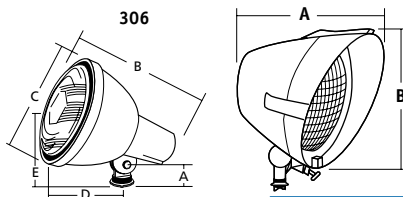

	A	B
306 Series	8 1/8"	9 7/8"
	206 mm	251 mm



# 308/309 Series

## Bullet Lampholders

- PAR/BR Lampholders, 150w max.
- Energy-saving 10 LED/15w, nominal 315 lumens, 3500K
- Decorative finishes vary
- Die-cast aluminum housing (and doors)
- Tempered glass lens
- Large 1/2" swivel knuckle, 308 down aim outdoors, 309 is universal aim
- Medium base porcelain socket (150w max) for PAR/BR models
- Available in Gray, Black, Green, Bronze, White and Verdi finishes; See ordering information
- CSA certified to UL 1598, CSA 22.2 No. 250.0-00, Suitable for wet locations
- Deep shield, wire guard accessories available



LANDSCAPE

### STOCK ORDERING INFORMATION

Catalog Number	Description	Finish	Weight lbs. (kg)	PKG. CODE
<b>Damp Location Listed - Aim Down Outdoors<sup>1</sup></b>				
308-13-M	8 1/4" long	Garden Green	2.25 (1)	BC
<b>Wet Location Listed - Universal Aiming<sup>2</sup></b>				
309-ML	9 7/8" long	Gray	3 (1.4)	BC
309-13-ML	9 7/8" long	Garden Green	3 (1.4)	BC
309-14-ML	9 7/8" long	Matte Black	3 (1.4)	BC
309-VG-ML	9 7/8" long	Verdi	3 (1.4)	BC
309-M51-ML	9 7/8" long	Dark Bronze	3 (1.4)	FCC
309-M54-ML	9 7/8" long	White	3 (1.4)	BC
<b>MADE-TO-ORDER LED - Wet Location Listed - Universal Aiming - 15w</b>				
30910LEDML	9 7/8" long	Bronze	5 (2.2)	BC

1 Use medium base PAR 38 lamps or smaller, 150w maximum

2 Use PAR 38 or BR40 lamps, 150w maximum

### STOCK ACCESSORIES - Order Separately

Catalog Number	Description	Weight lbs. (kg)	PKG. CODE
264 0097 9702	Clear lens	.5 (0.2)	BC
S-329-B	Cast round box, 4", 6-sided 1/2" back hub (wall or ceiling)	.75 (.3)	BC



C-5

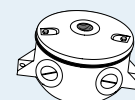

S-329-B

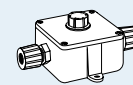

NM-BC

### MADE-TO-ORDER ACCESSORIES - Order Separately

Catalog Number	Description	Weight lbs. (kg)	PKG. CODE
1324	Zinc-plated wire guard	.25 (0.1)	BC
C-5	Wall or tree box, 3 mounting lugs in body; 2 1/2" hubs in "L" shape layout, side access plate	.25 (.11)	BC
NM-BC	Non-metallic high impact phenolic weatherproof box & cover, box is drilled at 180° for two burial cable connectors (included), allowing feed-through capability; gasketed cover has weathertight 1/2" hub; brass cover with screws; gray		BC
1414-BOX	Cast iron box - two side hubs, one top (1/2"); heavy-duty; gray	.8 (.4)	BC
1031-3	Cast spike with internal splice box, 1/2" NPSM hub for fixture & 6' #18/3 grounded cord set; gray	1.75 (.8)	BC



1414

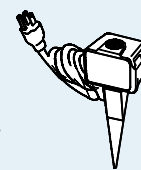

1031-3



1324

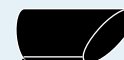

309-S

### DIMENSIONS

308 Series

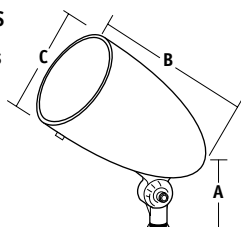

309 Series

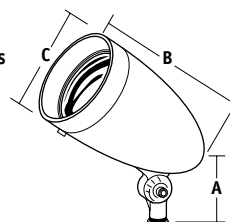

A	B	C
5"	8 1/4"	5 3/8"
127 mm	210 mm	137 mm

A	B	C
5"	9 7/8"	5 3/8"
127 mm	251 mm	137 mm



**HUBBELL**  
Outdoor Lighting

# Boxes & Covers

LANDSCAPE ACCESSORIES

Hubbell has a variety of junction boxes and covers to allow easy installation of lampholders, compact floodlights and landscape luminaires. Cast aluminum construction, gasketed covers designed for

wet locations and conduit plugs are standard. Boxes have a natural aluminum finish. Covers are painted gray or black.

## ORDERING INFORMATION: Cast Round Boxes

Catalog Number	Size in. (mm)	Hubs						Mt. Lugs	Weight lbs. (kg)	PKG. CODE	Source
		Side		Back		Cover					
		Qty.	Size	Qty.	Size	Qty.	Size				
S-314-B <sup>1</sup>	4 (102)	6	1/2"	1	1/2"	-	-	-	.75 (0.3)	BC	STOCK
S-329-B	4 (102)	4	1/2"	1	1/2"	1	1/2"	2	.75 (0.3)	BC	STOCK
S-319-B <sup>1</sup>	4 (102)	4	1/2"	1	1/2"	-	-	2	.75 (0.3)	BC	MADE-TO-ORDER

<sup>1</sup> Box furnished without cover; If cover required, order applicable cover as listed in covers for round boxes

## MADE-TO-ORDER ORDERING INFORMATION: Specialty Boxes (All Hubs Tapped NPSM)

Catalog Number	Description	Weight lbs. (kg)	PKG. CODE
C-5	Wall or tree box: 3 mounting lugs in body; 2 1/2" hubs in "L" shape layout - side access plate	.25 (.11)	BC

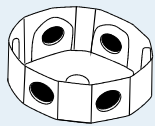

S-314-B

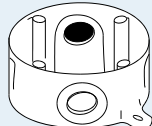

S-319-B

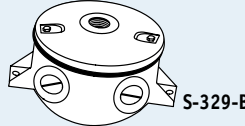

S-329-B

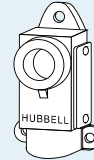

C-5



206-BC3

## ORDERING INFORMATION: Round Covers - Cast Aluminum With Hubs

Catalog Number	Size in. (mm)	Boxes Used With	Tapped Hubs		Finish	Weight lbs. (kg)	PKG. CODE	Source
			Qty.	Size				
206-BC3	4 (102)	3 1/4" x 4" (83 mm x 102 mm)	3	1/2"	Gray	.5 (0.2)	BC	STOCK
206-BC3-B	4 (102)	3 1/4" x 4" (83 mm x 102 mm)	3	1/2"	Black	.5 (0.2)	BC	MADE-TO-ORDER

# Landscape Accessories

• These accessories make it simple to install the various Lightscaper<sup>®</sup> fixtures.

• Two grades of burial junction boxes, portable spike mounts and 2 3/8" stub up fitters are specifically designed to mate with lampholders and louver lights

## STOCK ORDERING INFORMATION: Landscape Accessories

Catalog Number	Description	Weight lbs. (kg)	PKG. CODE
<b>Fitter</b>			
S-302	Slipfits 1 1/2" or 2" pipe (1.9" OD or 2 3/8" OD) with 1/2" N.P.S.M. hub; Gray	.6 (0.3)	BC

## MADE-TO-ORDER ORDERING INFORMATION: Landscape Accessories

Catalog Number	Description	Weight lbs. (kg)	PKG. CODE
<b>Junction Boxes</b>			
NM-BC	Non-metallic high impact phenolic weatherproof box and cover; Box is drilled at 180° for two burial cable connectors, included, allowing feed-through capability; Gasketed cover has weathertight 1/2" hub; Brass cover screws; Gray	—	BC
1414-BOX	Cast Iron Box - 2 side hubs, one top (1/2"); Heavy Duty; Gray	5 (2.3)	BC
<b>Ground Spikes</b>			
1031-3	Cast spike with internal splice box, 1/2" N.P.S.M. hub for fixture and 6' #18/3 grounded cord set; Gray	1.75 (0.8)	BC
<b>Fitters</b>			
S-302-M51	Slipfits 1 1/2" or 2" pipe (1.9" OD or 2 3/8" OD) with 1/2" N.P.S.M. hub; Bronze	.6 (0.3)	BC
S-302-M52	Slipfits 1 1/2" or 2" pipe (1.9" OD or 2 3/8" OD) with 1/2" N.P.S.M. hub; White	.6 (0.3)	BC

NM-BC

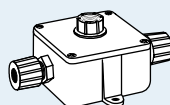

1414-BOX

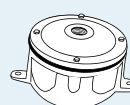

1031-3

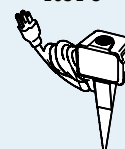

S-302





# HBL

## LED Highbay Series Severe Location

LED HIGHBAY



The LED Highbay Series is designed to efficiently light any large interior space with its high performance LED design and delivery of up to 100 lumens per watt of 5000 deg K light. The unique radial design with fins of durable cast aluminum allow it to operate in -40 °C to 55 °C ambient environments and keeps the LEDs cool resulting in an estimated 100,000 hours of life at L70.

The LED Highbay offers nine unique fixture versions for a wide variety of applications.

The LED Highbay is DesignLights Consortium® qualified for general highbay fixtures.

The total wattage ranges from 112-169 watts with a lumen output ranging from 10,000 to almost 17,000 lumens. The LED Highbay comes standard with 0-10v dimmable, universal voltage LED drivers with input from 120v to 277v at 50hz or 60 hz. Surge protection is included as standard. Complete fixture assembly is IP56. DLC Approved.

### STOCK ORDERING INFORMATION

Catalog Number	Description	Voltage	Color	Weight lbs. (kg)	PKG. CODE
HBL-72LU-NN-5K-W-070-ND-WH	HBL LED Highbay, 72 LED, No Mount, 5K, Wide, Non Dimming, White	120-277V	White	36.6 (16.6)	BC
HBL-72LU-NN-5K-N-070-ND-WH	HBL LED Highbay, 72 LED, No Mount, 5K, Narrow, Non Dimming, White	120-277V	White	36.6 (16.6)	BC
HBA2B	Pendant, 3/4" White	-	White	3 (1.3)	BC

### ORDERING INFORMATION



10-Day Quick Ship Ordering Guide  
Order Limit Per Fixture Selection: 15 – BC Pkg Code

<b>HBL</b>	-		-	<b>U</b>	-	<b>A</b>	-	<b>2</b>	-		-		-	<b>070</b>	-	<b>ND</b>	-		-	
<b>SERIES</b>	<b>MOUNT</b>		<b>HUB</b>		<b>DISTRIBUTION</b>		<b>DRIVE CURRENT</b>		<b>COLOR TEMPERATURE</b>		<b>DIMMING</b>		<b>COLORS</b>		<b>OPTIONS</b>					
HBL LED Highbay	A Pendant		2 3/4" Hub		N Narrow W Wide		070 700 MA		3K 3000K 4K 4000K 5K 5000K		ND Non-Dimming		BL Black GR Gray WH White		Fx Fusing (Replace "x" with voltage - Refer to spec sheet for more info.) ENCA Frosted Acrylic Protective Lens ENCG Glass Protective Lens OCS(X) Occupancy Sensor WG Bottom Wire Gaurd WIHUBB Wireless Control System					
<b>NUMBER OF LEDs</b>	<b>VOLTAGE</b>																			
60L 60 High brightness LEDs 72L 72 High brightness LEDs	U 120 - 277V																			

**Notes:** Voltage must be specified for Fusing and Occupancy Sensor compatibility. Refer to product spec sheet for 480V specification requirements

### Accessories - Order Separately

Catalog Number	Description
HOOK/LOOP	Fixture Mounting Hook
BLA-C4HLPX	Cord and Plug Set
LG2S	DUAL-LITE 250 VA LiteGear Emergency Lighting Inverter

Note: One (1) LED Highbay per LG2S

### DIMENSIONS

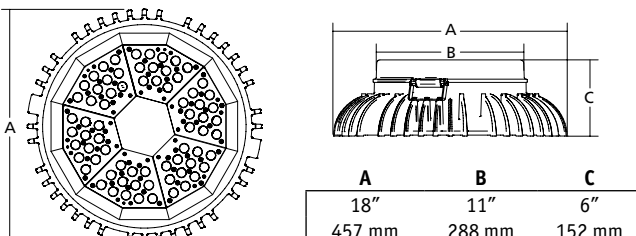

## LED Highbay Series Severe Location

**MADE-TO-ORDER ORDERING INFORMATION – (BC PKG CODE)**

<b>HBL</b>	-		-		-		-		-		-	<b>070</b>	-		-		-	
<b>SERIES</b> HBL LED Highbay		<b>MOUNT</b> A Pendant C Cone S Straight stancheon X Ceiling Y Yoke		<b>HUB</b> 2 3/4" Hub Available with A, C, X and Y Mount 3 1" Hub Available with A, C, X Mount 4 1 1/4" Hub 5 1 1/2" Hub Available with S Mount		<b>DISTRIBUTION</b> N Narrow W Wide A Aisle		<b>DRIVE CURRENT</b> 070 700 MA		<b>COLOR TEMPERATURE</b> 27K 2700K 3K 3000K 35K 3500K 4K 4000K 5K 5000K <b>Note:</b> Refer to product spec sheet for more details		<b>COLORS</b> BL Black GR Gray WH White		<b>DIMMING</b> CD Continuous Dimming ND Non-Dimming		<b>OPTIONS</b> Fx Fusing (Replace "x" with voltage - Refer to spec sheet for more info.) ENCA Frosted Acrylic Protective Lens ENCG Glass Protective Lens OCS(X) Occupancy Sensor WG Bottom Wire Gaurd WIHUBB Wireless Control System		
<b>NUMBER OF LEDS</b> 48L 48 High brightness LEDs 60L 60 High brightness LEDs 72L 72 High brightness LEDs		<b>VOLTAGE</b> U 120 - 277V 1 120V 2 208V 3 240V 4 277V 5 480V																

**Notes:** Voltage must be specified for Fusing and Occupancy Sensor compatibility. Refer to product spec sheet for 480V specification requirements

**Notes:**  
1. OCS unavailable with ENCA or ENCG options  
2. OCS and WIHUBB options can not be specified together

**PERFORMANCE INFORMATION**

Catalog Number	Input Watts	LEDs	Color Temperature	CRI	Total Lumens	Lumens per Watt	Ambient Temperature
HBL-48LU-5K-N-070-WH	112	48	5000°K	68	11206	100	45° C
HBL-48LU-5K-W-070-WH	112	48	5000°K	68	10778	96	45° C
HBL-48LU-5K-A-070-WH	112	48	5000°K	68	10213	91	45° C
HBL-60LU-5K-N-070-WH	139	60	5000°K	68	14007	101	45° C
HBL-60LU-5K-W-070-WH	139	60	5000°K	68	13472	97	45° C
HBL-60LU-5K-A-070-WH	139	60	5000°K	68	12776	92	45° C
HBL-72LU-5K-N-070-WH	169	72	5000°K	68	16808	99	45° C
HBL-72LU-5K-W-070-WH	169	72	5000°K	68	16166	96	45° C
HBL-72LU-5K-A-070-WH	169	72	5000°K	68	15319	91	45° C



# NV2 Series

## Enclosed & Gasketed

- Typical applications include manufacturing plants, chemical and petrochemical processing facilities, sewage treatment plants, offshore and dockside installations, agricultural, commercial, industrial, mining, and marine facilities
- NV2 Series non-metallic light fixtures combine an outstanding balance of strength, stiffness, toughness and electrical properties
- Energy and labor-saving fluorescent or incandescent models
- Accessories include polycarbonate dome reflectors and wall extension

- Molded from 30% glass-filled thermoset polyester for high strength
- Resists corrosive effects of most chemicals, hydrocarbons and solvents
- Designed for indoor and outdoor applications
- UL1598 Standard for luminaires
- UL 1598A Marine type luminaires
- UL 844 Standard for lighting fixtures for hazardous locations
- CSA C22.2 no. 137-M1981 electric luminaires for use in hazardous locations
- Enclosed and gasketed
- NEMA 3, 4X; IP66



HAZARDOUS SEALED

Class I, Div. 2, Groups A, B, C, D • Class I, Zone 2, Groups IIC, IIB, IIA  
Class II, Div. 2, Groups F, G, C, D • Class III • NEMA 4X, IP66, Marine Rated

**MADE-TO-ORDER** ORDERING INFORMATION – (BC PKG CODE)

STOCK Components <sup>1</sup>	
Catalog Number	Description
040541B	Lamp, 32w SYLV CF32DT/E/IN/830
0460542B	Lamp, 42w SYLV CF42DT/E/IN/830
0460543B	Lamp, 26w SYLV CF26DT/E/IN/830
0460547B	Lamp, 18w SYLV CF18DT/E/IN/827
NV2AG	3/4" Pendant splice box
NV2XG	3/4" Ceiling splice box (M20 entry NV2MG)
NV2BG	Elbow (used between NV2XG & fixture body)
NV2GG	Guard
NV2FG18	18w Fluor. body 120VAC - 277V 50/60Hz
NV2FG26	26 Fluor. body 120VAC - 277V 50/60Hz
NV2FG32	32w Fluor. body 120VAC - 277V 50/60Hz
NV2FG42	42w Fluor. body 120VAC - 277V 50/60Hz
NV2CG	Gray blank cover for NV2XG
VG-15	Clear, standard
VRGP-100	Ruby, tempered

1 Fluorescent "bodies only" do not include lamps

### Colored Globe Options<sup>2</sup>

Suffix Standard Globe	Suffix Tempered Globe	Description
A	A	Amber
B	B	Blue
R	R	Ruby
G	N/A	Green
P	N/A	Purple
BG	BG	Blue-Green

2 Tempered globes are required for Wet Location applications

Catalog Number		Type	PKG. CODE
Standard Globe	Tempered Globe		
<b>Pendant 3/4" Fixture with Clear Globe &amp; Guard</b>			
NV2IG15ASG	NV2IG15AHG	150w Incandescent	BC
NV2FG13ASG	NV2FG13AHG	13w Fluorescent	BC
NV2FG18ASG	NV2FG18AHG	18w Fluorescent	BC
NV2FG26ASG	NV2FG26AHG	26w Fluorescent	BC
NV2FG32ASG	NV2FG32AHG	32w Fluorescent	BC
NV2FG42ASG	NV2FG42AHG	42w Fluorescent	BC
<b>Ceiling 3/4" Fixture with Clear Globe &amp; Guard</b>			
NV2IG15XSG	NV2IG15XHSG	150w Incandescent	BC
NV2FG13XSG	NV2FG13XHSG	13w Fluorescent	BC
NV2FG18XSG	NV2FG18XHSG	18w Fluorescent	BC
NV2FG26XSG	NV2FG26XHSG	26w Fluorescent	BC
NV2FG32XSG	NV2FG32XHSG	32w Fluorescent	BC
NV2FG42XSG	NV2FG42XHSG	42w Fluorescent	BC
<b>Wall 3/4" Fixture with Clear Globe &amp; Guard</b>			
NV2IG15BSG	NV2IG15BHSG	150w Incandescent	BC
NV2FG13BSG	NV2FG13BHSG	13w Fluorescent	BC
NV2FG18BSG	NV2FG18BHSG	18w Fluorescent	BC
NV2FG26BSG	NV2FG26BHSG	26w Fluorescent	BC
NV2FG32BSG	NV2FG32BHSG	32w Fluorescent	BC
NV2FG42BSG	NV2FG42BHSG	42w Fluorescent	BC

- Notes:
- Tempered Globes are required for Wet Location applications
  - All assemblies are unit packed with required components (not assembled)
  - Fluorescent unit pack models (only) include the lamp
  - Reflector is sold separately; For wall mounting with reflector, the NVEXTG extension is required and sold separately
  - Fluorescent models use "world voltage" ballasts for 120VAC through 277VAC, 50/60Hz applications

### MADE-TO-ORDER

#### ORDERING INFORMATION: 150w GLOBES V/NV/NVQ

Catalog Number	Description
VCGP-100	Clear, tempered
VCGPT-100	Clear, tempered w/ Tuffskin® coating
VAMG-100	Amber
VGG-100	Blue Green
VGGP-100	Blue Green, tempered
VBG-1001	Blue
VBGP-100	Blue, tempered
VRG-100	Ruby
VRGP-100	Ruby, tempered
VRSG-100	Green
VPG-100	Purple
VPLGC-100	Polycarbonate (cannot be used with guard or in high ambient temperature locations -40°C/104°F max.) Not UL listed

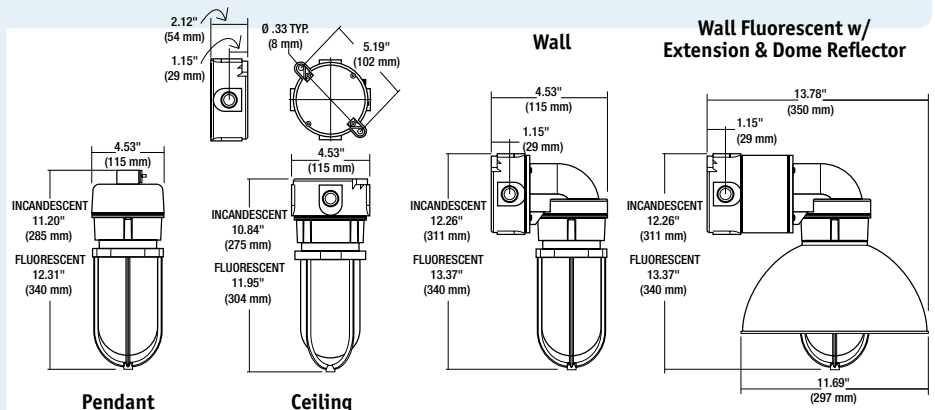

**HUBBELL**  
Industrial Lighting

# BX4QL/IBX4QL/RMN4QL 120

## 4" LED QuickLink

California Title 24 Compliant

RECESSED



IBX4QL-120



### FEATURES

- Ideal for residential and light commercial lighting projects that require a small, concealed line-voltage source.
- RMN4QL-120 remodel housing allows for quick and easy installation into existing ceilings
- Nail included on bar hangers.
- Suitable for wet locations and through wiring
- Luminaires are certified by a National Recognized Testing Lab (NRTL), either UL or CSA

### STOCK

### ORDERING INFORMATION

EXAMPLE: BX4QL-120-LB4LEDA6L30K9 WH

LB4LEDA6L	30K	9	WH
<b>TRIM</b>	<b>LED COLOR TEMP</b>	<b>CRI</b>	<b>TRIM COLOR</b>
LB4LEDA6L <sup>1</sup> 4" LED QuickLink trim	30K 3000 Kelvin	9 90+ CRI	WH White

### MADE-TO-ORDER

### ORDERING INFORMATION

BX4QL-120	
<b>HOUSING</b>	<b>ACCESSORIES</b>
<b>BX4QL-120</b> 4" line voltage Non-IC housing, new construction applications	<b>G4<sup>2</sup></b> Ceiling gasket for the 4" line voltage housings. Seals housing to drywall opening
<b>IBX4QL-120</b> 4" line voltage IC housing, new construction applications, AirShield™ rated	<b>ICBOX</b> Recessed enclosure for Non-IC housing in IC applications. See page 274.
<b>RMN4QL-120</b> 4" line voltage Non-IC housing, Remodel applications.	



### QuickLink: California Title 24 Compliant Connectors

QUICKLINK trims comply with the requirements of California Title 24 by providing a plug-in power connector in place of a screw shell socket. Ideal for residential and light commercial new construction applications where the use of screw shell sockets is restricted. The LB4LEDA trim is compatible with both an Edison Base and QL base housing.

### NOTES

- <sup>1</sup> See trim dimensions on page 330
- <sup>2</sup> IBX4QL-120 only

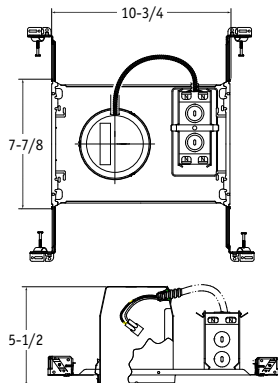

Ceiling Cut Out: 4-1/2"  
Maximum Ceiling Thickness: 2-1/2"  
**BX4QL-120**

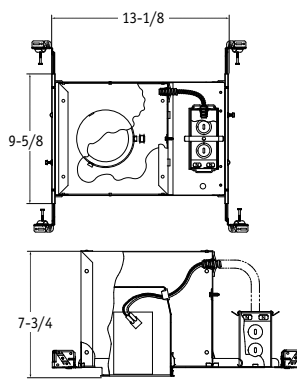

Ceiling Cut Out: 4-1/2"  
Maximum Ceiling Thickness: 2-1/2"  
**IBX4QL-120**

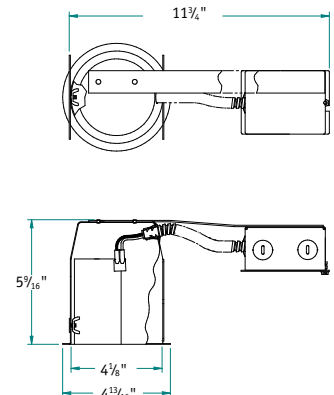

Ceiling Cut Out: 4-1/2"  
Maximum Ceiling Thickness: 1"  
**RMN4QL-120**



# LBSLED/LBSQLED

## 7" Surface Mount LED Downlight 120V

### FEATURES

- Installs to Standard 4x4 J-Box
- Energy saving LED light engine with 17-watt input power
- Lumen out put and distribution comparable up to 100W incandescent
- Photometrics tested per IESNA-LM-79-2008 standards.
- Retrofit applications with compatible 4", 5", or 6" housings using the optional mounting kit.
- 42,000 hours life at 70% lumen maintenance per TM-21
- ENERGY STAR® Qualified
- IC/Non-IC rated. Suitable for wet locations.
- Luminaires are certified by a National Recognized Testing Lab (NRTL), either UL or CSA.
- 972 Delivered Lumens, 17 Watts
- Dimmable to 15% using many LED rated dimmers



LITEBOX

### STOCK

ORDERING INFORMATION – (BC PKG CODE) EXAMPLE:LBSLEDA10L30K WH

LBSLEDA10L	30K	9	WH	
TRIM	LED COLOR	CRI	TRIM COLOR	ACCESSORIES
<b>LBSLEDA10L</b> Surface Mount Round LED Module	<b>30K</b> 3000 Kelvin	<b>9</b> 90+ CRI	<b>WH</b> White	<b>LiteGear</b> See spec sheet for availability
<b>LBSQLEDA10L</b> Surface Mount Square LED Module				<b>LBSMTGKIT</b> Mounting kit for LiteBox LED Surface fixtures to install into most 4", 5", or 6" recessed cans. Set of 8.

### Mounting Options:

#### J-Box Mount with quick link

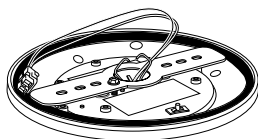

J-Box Adapter

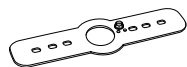

#### Recessed Mount with optional LBSMTGKIT

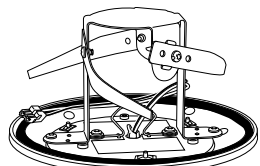

Recessed Adapter



E26 Edison Base Adapter



#### 7" Round LiteBox LED

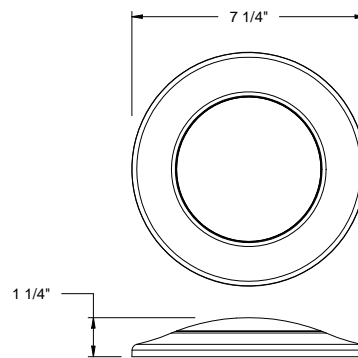

#### 7" Square LiteBox LED

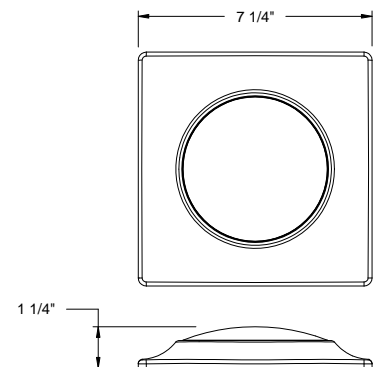



# DBXQL

## 6" LED QuickLink

California Title 24 Compliant

LITEBOX

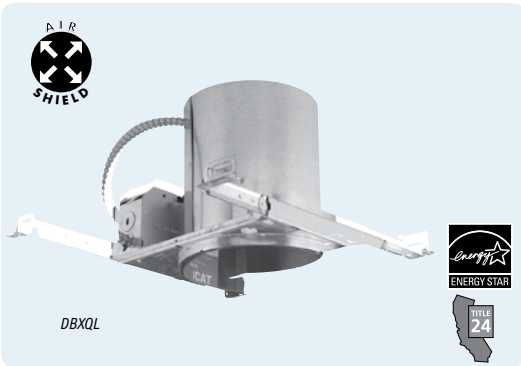

### FEATURES

- Energy saving LED light engine with 12-14-watt input power
- California Title 24 compliant QuickLink connectors on housings and trims
- Lumen output and distribution comparable up to 75W PAR incandescent lamp.
- Photometrics tested per IESNA LM-79-2008 standards
- 60,000 hour life at 70% lumen maintenance per TM-21
- Heat sink to maximize life expectancy and lumen output.
- Excellent glare control and optical cutoff
- Dimmable to 15% with most standard dimmers
- IC/Non-IC, AirShield rated. Wet location with LB6LEDA.
- Luminaires are certified by a National Recognized Testing Lab (NRTL), either UL or CSA.

### STOCK

ORDERING INFORMATION – (BC PKG CODE)

EXAMPLE: DBXQL-LB6LEDA30K WH

<b>DBXQL</b>	-	<b>LB6LEDA</b>	<b>30K</b>		<b>WH</b>
<b>HOUSING</b>		<b>TRIM</b>	<b>LED COLOR TEMP</b>	<b>CRI</b>	<b>TRIM COLOR</b>
<b>DBXQL</b> 6" LED QuickLink housing		<b>LB6LEDA8L</b> <sup>1</sup> 6" 800 Lumen LED QuickLink trim <b>LB6LEDA10L</b> <sup>1</sup> 6" 1000 Lumen LED QuickLink trim	<b>30K</b> 3000 Kelvin <b>35K</b> <sup>2</sup> 3500 Kelvin	<b>Blank</b> 80+ CRI	<b>WH</b> White <b>BL</b> <sup>2</sup> Black <b>Z</b> <sup>2</sup> Zet <b>BZ</b> <sup>2</sup> Bronze

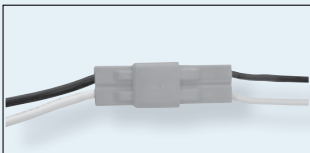
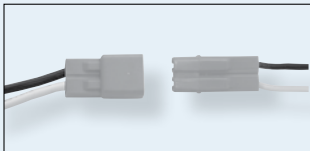

QuickLink: California Title 24 Compliant Connectors

QUICKLINK trims comply with the requirements of California Title 24 by providing a plug-in power connector in place of a screw shell socket. Ideal for residential and light commercial new construction applications where the use of screw shell sockets is restricted. The LB6LEDA trim is compatible with both an Edison Base and QL base housing.

### NOTES

- <sup>1</sup> See trim dimensions on page 329
  - <sup>2</sup> Not available for LB6LEDA8L
- See spec sheet or [www.dual-lite.com](http://www.dual-lite.com) for LiteGear Compatibility Matrix

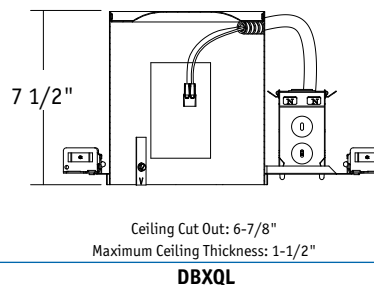
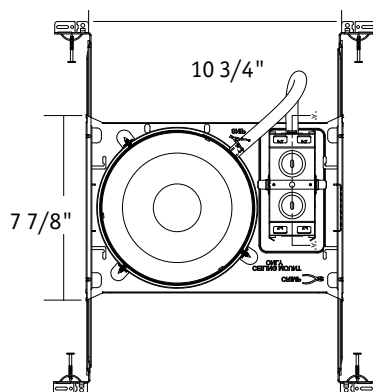

# LB6LEDA

6" LED Trims

## FEATURES

- Energy saving LED light engine with 12-14-watt input power
- Lumen output and distribution comparable up to 75W PAR incandescent lamp
- Photometrics tested per IESNA LM-79-2008 standards
- New construction with DBXQL, California Title 24 compliant
- Retrofit applications with compatible 6" housings using the universal screw base adapter (see below)
- Dimmable to 15% with most standard dimmers
- Easy installation with (3) friction spring clips and diffuse acrylic lens controls direct glare
- 60,000 hours life at 70% lumen maintenance per TM-21
- Heat sink to maximize life expectancy and lumen output
- ENERGY STAR® Qualified
- IC/Non-IC rated. Suitable for wet locations.
- Luminaires are certified by a National Recognized Testing Lab (NRTL), either UL or CSA.



LITEBOX

## STOCK

ORDERING INFORMATION – (BC PKG CODE) EXAMPLE: LB6LEDA30K WH

<b>LB6LEDA</b>	<b>30K</b>		<b>WH</b>	
<b>TRIM</b>	<b>LED COLOR TEMP</b>	<b>CRI</b>	<b>TRIM COLOR</b>	<b>ACCESSORIES</b>
<b>LB6LEDA8L</b> 6" 800 Lumen LED module with dimming to 15% 120V  <b>LB6LEDA10L</b> 6" 1000 Lumen LED module with dimming to 15% 120V	<b>30K</b> 3000 Kelvin <b>35K<sup>1</sup></b> 3500 Kelvin	<b>Blank</b> 80+ CRI	<b>WH</b> White <b>BL<sup>1</sup></b> Black <b>Z<sup>1</sup></b> Zet <b>BZ<sup>1</sup></b> Bronze	<b>LiteGear</b> See spec sheet for availability <b>DBXQL</b> IC/Non-IC, Airtight housing with supply wire quick connects
<b>NOTES</b> <sup>1</sup> Available with LB6LEDA10L only. <sup>*</sup> See spec sheet or www.dual-lite.com for LiteGear Compatibility Matrix and compatible dimmers				
<b>LB6LEDA</b> Compatible for use with Prescolite DBX, IBXHW, RMNICD, & FT6. Partial list of competitor IC & Non-IC housings UL classified with 6" trims includes: <b>Manufacturer</b> Capri Commercial Electric Elco Emerald Halo Intense Jimway Juno Lithonia LumaPro Luminaire Nora Progress Sea Gull WAC  For complete list of competitor part numbers, see spec sheet at www.Prescolite.com				

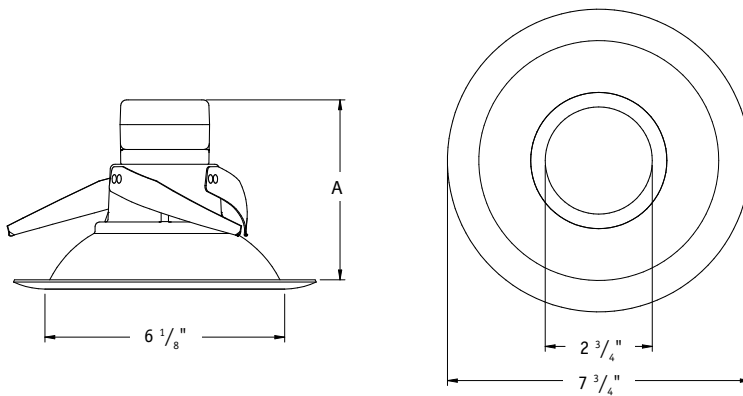

LB6LEDA

<b>Dim. A</b>	<b>LB6LEDA8L = 3-5/8"</b>
	<b>LB6LEDA10L = 4-5/8"</b>

## Combination LED Exit/Light



### FEATURES

- Combination unit for commercial applications
- UV stable thermoplastic white or black housing available
- Long life LED lamps in exit sign rated at 50,000 hour life expectancy
- LED Lamps with a life-cycle of more than 10 years
- Dual-voltage 120 or 277V AC input
- Remote capacity or extended runtime option
- Long-life Nickel Cadmium battery with fully automatic charger
- UL 924 Damp Location Listed

### STOCK

### ORDERING INFORMATION

CATALOG NUMBER	DESCRIPTION	PKG. CODE
CCR	White Thermoplastic, Combination Exit/Emergency Light, Universal Face, Red Letters	SCC
CCRB	Black Thermoplastic, Combination Exit/Emergency Light, Universal Face, Red Letters	SCC
CCG	White Thermoplastic, Combination Exit/Emergency Light, Universal Face, Green Letters	SCC
CCGB	Black Thermoplastic, Combination Exit/Emergency Light, Universal Face, Green Letters	SCC
CCRRC	White Thermoplastic, Combination Exit/Emergency Light, Universal Face, Red Letters, Remote Capacity	SCC
CCRRCB	Black Thermoplastic, Combination Exit/Emergency Light, Universal Face, Red Letters, Remote Capacity	SCC
CCGRC	White Thermoplastic, Combination Exit/Emergency Light, Universal Face, Green Letters, Remote Capacity	SCC

Note: Remote Capacity Unit will only power the Compass Indoor and Outdoor Remote(CIR and COR Series)

### MATCHING REMOTE FIXTURES

MODEL	DESCRIPTION
CIR	LED Indoor Remote Heads
COR	LED Outdoor Remote Heads

### ACCESSORIES

MODEL	DESCRIPTION
WGEL	Wall Mount Wireguard- 8" H X 20" W X 8" D



CCGB

### ELECTRONICS

- 90 minute emergency operation with 1 double or 2 single remotes
- Test switch and LED AC-on indicator light



CIRS



CIRD



CORD



CORS

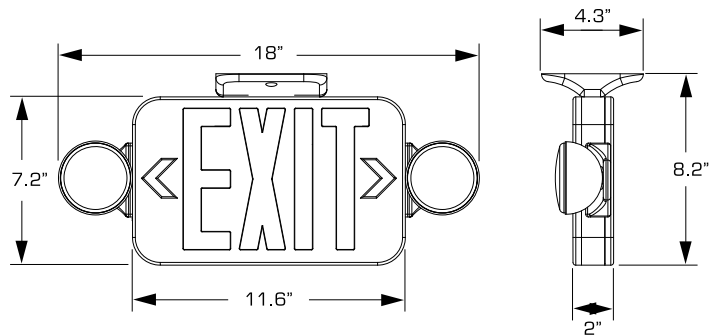

Single Carton Weight: 2.5 lbs.  
Master Carton Quantity: 6 each

## Thin Die-Cast LED Emergency Exit

### FEATURES

- Thin die-cast aluminum Exit sign for commercial or light industrial applications
- Painted black housing with brushed aluminum face
- Long life LED lamps provide bright, even illumination
- Universal end or ceiling mount with canopy included
- Dual-voltage 120 or 277V AC input
- Emergency models include long-life Nickel Cadmium battery
- UL 924 Damp Location Listed



### STOCK ORDERING INFORMATION

CATALOG NUMBER	DESCRIPTION	PKG. CODE
CCESRE	Die-Cast Exit, Brushed Face, Black Housing, Single-Face, Red Letters, Emergency	SCC
CCEDRE	Die-Cast Exit, Brushed Face, Black Housing, Double-Face, Red Letters, Emergency	SCC
CCESGE	Die-Cast Exit, Brushed Face, Black Housing, Single-Face, Green Letters, Emergency	SCC
CCEDGE	Die-Cast Exit, Brushed Face, Black Housing, Double-Face, Green Letters, Emergency	SCC
CCESR	Die-Cast Exit, Brushed Face, Black Housing, Single-Face, Red Letters, AC	SCC
CCEDR	Die-Cast Exit, Brushed Face, Black Housing, Double-Face, Red Letters, AC	SCC
CCESG	Die-Cast Exit, Brushed Face, Black Housing, Single-Face, Green Letters, AC	SCC
CCEDG	Die-Cast Exit, Brushed Face, Black Housing, Double-Face, Green Letters, AC	SCC

### ELECTRONICS

- 90 minute emergency operation
- AC or Emergency operation
- Test switch and LED AC-on indicator light

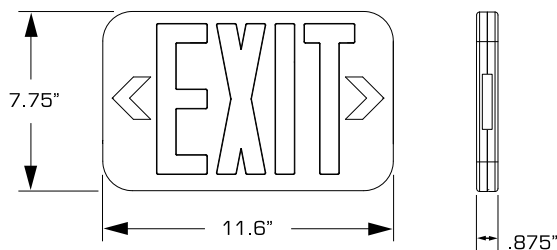

Single Carton Weight: 2.8 lbs.  
Master Carton Quantity: 8 each

## LED Emergency Exit



### FEATURES

- Exit sign for commercial applications
- UV stable thermoplastic white or black housing available
- Long life LED lamps provide bright, even illumination
- Universal end or ceiling mount
- Dual-voltage 120 or 277V AC input
- Remote capacity or extended runtime option
- Long-life Nickel Cadmium battery with fully automatic charger
- UL 924 Damp Location Listed

### STOCK ORDERING INFORMATION

CATALOG NUMBER	DESCRIPTION	PKG. CODE
CER	White Thermoplastic Exit, Universal Face, Red LED Emergency Exit	SCC
CERB	Black Thermoplastic Exit, Universal Face, Red LED Emergency Exit	SCC
CEG	White Thermoplastic Exit, Universal Face, Green LED Emergency Exit	SCC
CEGB	Black Thermoplastic Exit, Universal Face, Green LED Emergency Exit	SCC
CERRC	White Thermoplastic Exit, Universal Face, Red LED Emergency Exit, Remote Capacity	SCC
CERRCB	Black Thermoplastic Exit, Universal Face, Red LED Emergency Exit, Remote Capacity	SCC
CEGRC	White Thermoplastic Exit, Universal Face, Green LED Emergency Exit, Remote Capacity	SCC

Note: Remote Capacity Unit will only power the Compass Indoor and Outdoor Remote(CIR and COR Series)

### MATCHING REMOTE FIXTURES

MODEL	DESCRIPTION
CIR	LED Indoor Remote Heads
COR	LED Outdoor Remote Heads

### ACCESSORIES

MODEL	DESCRIPTION
WGLX	Wall Mount Wireguard- 10" H X 14" W X 2.25" D

### ELECTRONICS

- 90 minute emergency operation with 1 double or 2 single remotes
- Test switch and LED AC-on indicator light



CEGB

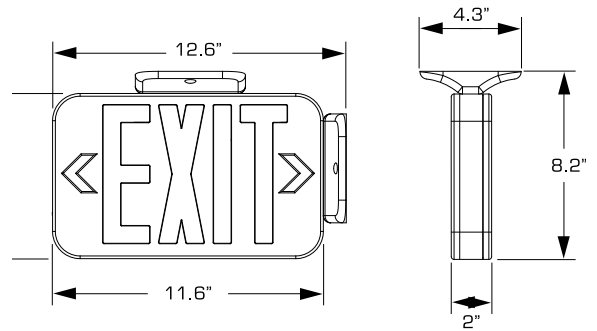

Single Carton Weight: 2 lbs.  
Master Carton Quantity: 6 each



CIRS



CIRD



CORD



CORS

### FEATURES

- Edgelit exit sign for architectural applications
- Brushed aluminum housing with field installed directional arrows
- Long life LED lamps provide bright, even illumination
- Recessed or surface mount with canopy included
- Mirror divider on single and double-face models
- Dual-voltage 120 or 277V AC input
- Emergency models include long-life Nickel Cadmium battery
- UL 924 listed



### STOCK ORDERING INFORMATION

CATALOG NUMBER	DESCRIPTION	PKG. CODE
CELS1RNE	Edge-Lit Exit, Surface Mount, Single Face, Red Letters, Brushed Aluminum, Battery	SCC
CELS1GNE	Edge-Lit Exit, Surface Mount, Single Face, Green Letters, Brushed Aluminum, Battery	SCC
CELS2RNE	Edge-Lit Exit, Surface Mount, Double Face, Red Letters, Brushed Aluminum, Battery	SCC
CELS2GNE	Edge-Lit Exit, Surface Mount, Double Face, Green Letters, Brushed Aluminum, Battery	SCC
CELR1RNE	Edge-Lit Exit, Recessed Mount, Single Face, Red Letters, Brushed Aluminum, Battery	SCC
CELR1GNE	Edge-Lit Exit, Recessed Mount, Single Face, Green Letters, Brushed Aluminum, Battery	SCC
CELR2RNE	Edge-Lit Exit, Recessed Mount, Double Face, Red Letters, Brushed Aluminum, Battery	SCC
CELR2GNE	Edge-Lit Exit, Recessed Mount, Double Face, Green Letters, Brushed Aluminum, Battery	SCC

Note: Remote Capacity Unit will only power the Compass Indoor and Outdoor Remote(CIR and COR Series)

### ELECTRONICS

- 90 minute emergency operation with 1 double or 2 single remotes
- Test switch and LED AC-on indicator light

### ADDITIONAL MOUNTING OPTIONS

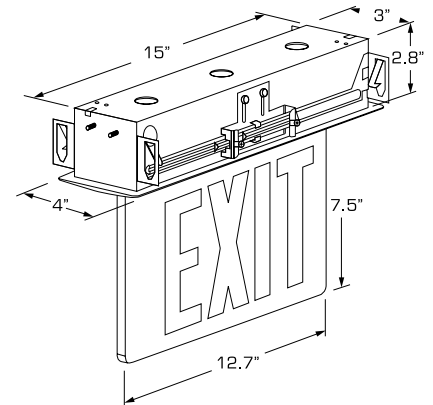
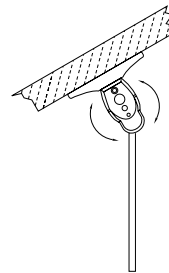
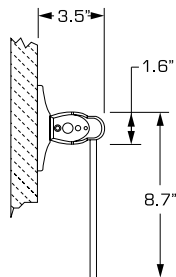
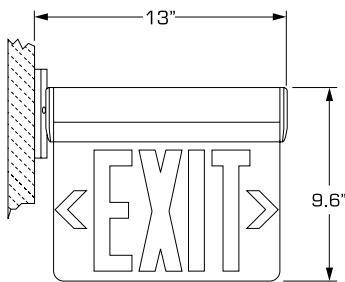



## Wet Location LED Emergency Exit



### FEATURES

- Exit sign for wet location or light industrial environments
- UV stable thermoplastic grey housing with polycarbonate lens
- Long life LED lamps provide bright, even illumination
- Single face end, wall or ceiling mount
- Double face end or ceiling mount
- Dual-voltage 120 or 277V AC input
- Long-life Nickel Cadmium battery with fully automatic charger
- UL 924 Wet Location Listed

### STOCK ORDERING INFORMATION

CATALOG NUMBER	DESCRIPTION	PKG. CODE
CEWSRE	Thermoplastic, Wet Location Exit, Single-Face, Red Letters, Emergency	SCC
CEWDRE	Thermoplastic, Wet Location Exit, Double-Face, Red Letters, Emergency	SCC
CEWSGE	Thermoplastic, Wet Location Exit, Single-Face, Green Letters, Emergency	SCC
CEWDGE	Thermoplastic, Wet Location Exit, Double-Face, Green Letters, Emergency	SCC

### ELECTRONICS

- 90 minute emergency operation
- Test switch and LED AC-on indicator light

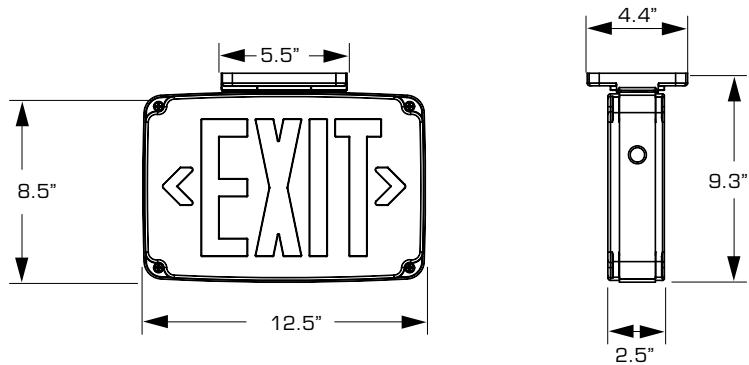

Single Carton Weight: 4.3 lbs.  
Master Carton Quantity: 6 each

### FEATURES

- Single or Double lamp-head remote with base-plate
- LED life-cycle of more than 10 years
- Quick installation
- Dual-voltage 120 or 277V AC input
- UL924 Damp Location Listed
- Fully adjustable lamp-heads



### STOCK

### ORDERING INFORMATION

CATALOG NUMBER	DESCRIPTION	PKG. CODE
CIRS	LED Remote, Single Mounting Base, 3 VDC, 1 Watt	SCC
CIRD	LED Remote, Double Mounting Base, 3 VDC, 1 Watt	SCC

Note: Powered by the Compass Exit, Combo or Emergency Light with Remote Capacity

CIRS

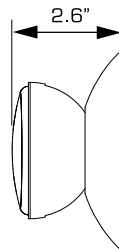
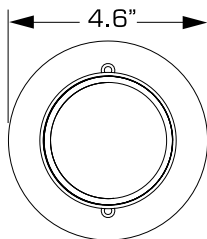

**Single Remote Carton Weight:** 1 lbs.  
**Master Carton Quantity:** 20 each

CIRD

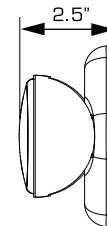
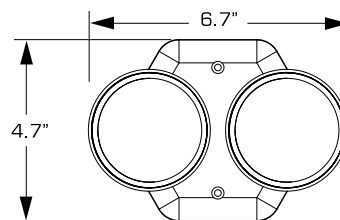

**Double Remote Carton Weight:** 1.2 lbs.  
**Master Carton Quantity:** 20 each

# COR

## LED Outdoor Remote

REMOTE



### FEATURES

- Single or Double lamp-head remote with base
- LED life-cycle of more than 10 years
- Quick installation
- Fully adjustable lamp-heads
- Fully gasketed for application in wet environment

### STOCK

### ORDERING INFORMATION

CATALOG NUMBER	DESCRIPTION	PKG. CODE
CORS	LED Outdoor Remote, Single, Mounting Base, 3 VDC, 1 Watt	SCC
CORD	LED Outdoor Remote, Double, Mounting Base, 3 VDC, 1 Watt	SCC

Note: Powered by Compass Exit, Combo or Emergency Light with Remote Capacity

### CORS

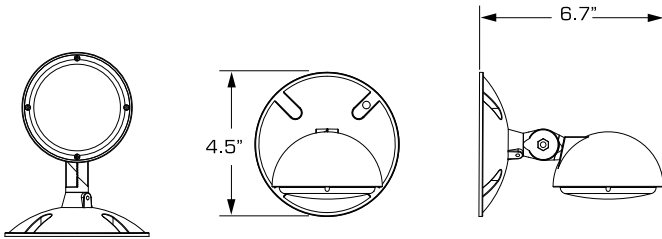

Single Remote Carton Weight: 1 lbs.  
Master Carton Quantity: 20 each

### CORD

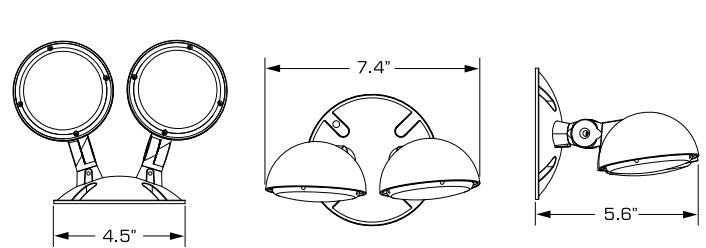

Double Remote Carton Weight: 1.2 lbs.  
Master Carton Quantity: 20 each

### FEATURES

- Emergency unit for commercial applications
- UV stable thermoplastic white or black housing available
- Quick installation with fully adjustable lamp-heads
- LED Lamps with a life-cycle of more than 10 years
- Dual-voltage 120 or 277V AC input
- Remote capacity or extended runtime option
- Long-life Nickel Cadmium battery with fully automatic charger
- UL 924 Damp Location Listed

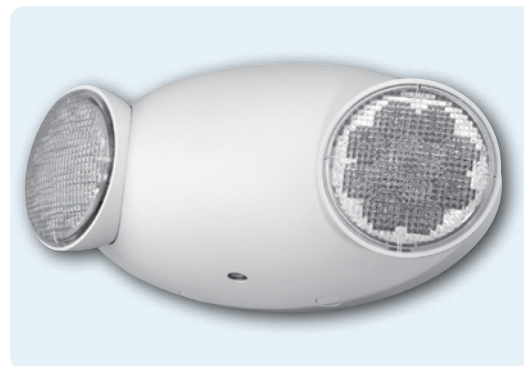

### STOCK

### ORDERING INFORMATION

CATALOG NUMBER	DESCRIPTION	PKG. CODE
CU2	White Thermoplastic, Dual-Head LED Emergency Light , 120/277 Input, Damp Location Listed, 3 VDC, 1 Watt	SCC
CU2B	Black Thermoplastic, Dual-Head LED Emergency Light, 120/277 Input, Damp Location Listed, 3 VDC, 1 Watt	SCC
CU2RC	White Thermoplastic, Dual-Head LED Emergency Light, 120/277 Input, Damp Location Listed, Remote Capacity, 3 VDC, 1 Watt	SCC
CU2RCB	Black Thermoplastic, Dual-Head LED Emergency Light, 120/277 Input, Damp Location Listed, Remote Capacity, 3 VDC, 1 Watt	SCC

Note: Remote Capacity Unit will only power the Compass Indoor and Outdoor Remote(CIR and COR Series)

### MATCHING REMOTE FIXTURES

#### MODEL DESCRIPTION

**CIR** LED Indoor Remote Heads

**COR** LED Outdoor Remote Heads

### ACCESSORIES

#### MODEL DESCRIPTION

**WGLZ** Wireguard- 6.25" H X 14" W X 4" D

### ELECTRONICS

- 90 minute emergency operation
- Test switch and LED AC-on indicator light



CU2B



CIRS



CIRD



CORD



CORS

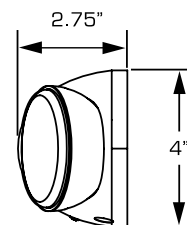
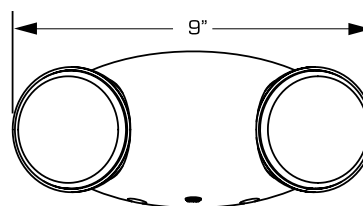

Single Carton Weight: 1 lbs.  
Master Carton Quantity: 12 each

# CU2W

## Wet Location LED Emergency Light

FLOODLIGHTS



### FEATURES

- Emergency unit for wet location or light industrial applications
- UV stable thermoplastic grey housing available
- Quick installation with fully adjustable lamp-heads
- LED Lamps with a life-cycle of more than 10 years
- Dual-voltage 120 or 277V AC input
- Provided with water-proof test switch and AC-On indicator
- Remote capacity or extended runtime standard
- Long-life Nickel Cadmium battery with fully automatic charger
- UL 924 Wet Location Listed

### STOCK ORDERING INFORMATION

CATALOG NUMBER	DESCRIPTION	PKG. CODE
CU2WG	Wet Location LED emergency light, Dual-Head Fully Adjustable, Grey Finish, Remote Capacity, 120/277 Input, 1.9 watts	SCC
CU2WB	Wet Location LED emergency light, Dual-Head Fully Adjustable, Black Finish, Remote Capacity, 120/277 Input, 1.9 watts	SCC

Note: Unit will only power 1 each Compass CWRD or 2 each CWRS remotes

### MATCHING REMOTE FIXTURES

MODEL	DESCRIPTION
CWRS	LED Outdoor Remote, Single
CWRD	LED Outdoor Remote, Double

### ACCESSORIES

MODEL	DESCRIPTION
WGEL	Wireguard- 8" H X 20" W X 8" D

### ELECTRONICS

- 90 minute emergency operation with 1 double or 2 single remotes
- Test switch and LED AC-on indicator light

### CWRS

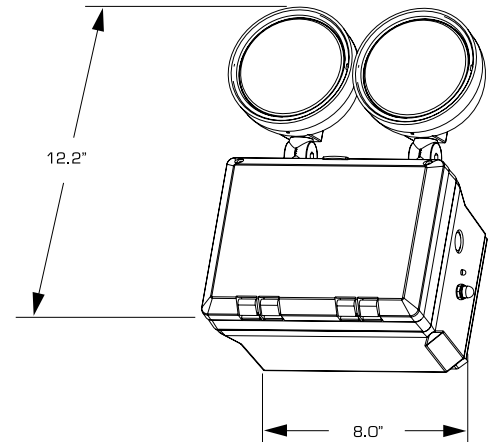

Single Carton Weight: 7.5 lbs.  
Master Carton Quantity: 4 each

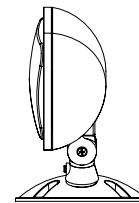
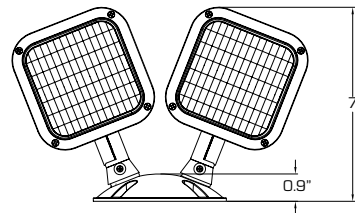
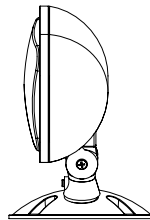
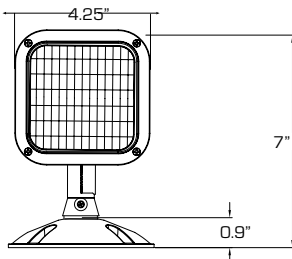
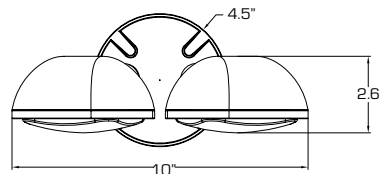
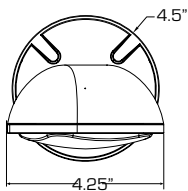

## International Voltage SALIDA LED Exit

### FEATURES

- LED life-cycle of more than 10 years
- Molded-in template for Quick installation
- Meets International input voltage requirements
- Optimal long-life 4.8V Nickel Cadmium battery for 90 minute emergency lighting
- Provided with test switch and AC-On indicator
- Canopy Included



### STOCK ORDERING INFORMATION

CATALOG NUMBER	DESCRIPTION	PKG. CODE
CSRIV	120/220-240VAC, 50/60Hz., Universal SALIDA Face, Red LED, AC only	SCC
CSREIV	120/220-240VAC, 50/60Hz., Univ. SALIDA Face, Red LED Emergency, NiCad battery	SCC

### ENERGY CONSUMPTION

CATALOG NUMBER	INPUT WATT (W)		INPUT AMPS (A)	
	120 VAC	230VAC	120VAC	230VAC
CSR Models	3.8	3.8	0.034	0.02

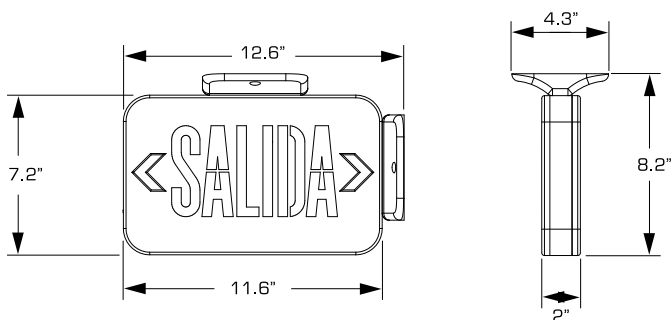

Single Carton Weight: 2 lbs.  
Master Carton Quantity: 6 each



# INDEX

## Product Index

103	60	HUBBELL OUTDOOR	BL-400P-LB-EX-Q	66	HUBBELL INDUSTRIAL	CU2B	79	COMPASS
306	60	HUBBELL OUTDOOR	BO-GX	30	HUBBELL OUTDOOR	CU2RC	79	COMPASS
1308	60	HUBBELL OUTDOOR	BO-SX	30	HUBBELL OUTDOOR	CU2RCB	79	COMPASS
1324	60,61	HUBBELL OUTDOOR	BOF-01	30	HUBBELL OUTDOOR	CU2WB	80	COMPASS
1324	60,61	HUBBELL OUTDOOR	BOF-02	30	HUBBELL OUTDOOR	CU2WG	80	COMPASS
1324	63	HUBBELL OUTDOOR	BOF-04	30	HUBBELL OUTDOOR	DBXQL	70	PRESCOLITE
4040	16	HUBBELL OUTDOOR	BOI-01	30	HUBBELL OUTDOOR	DDL-140L-1	52	HUBBELL OUTDOOR
4040	21	HUBBELL OUTDOOR	BOI-02	30	HUBBELL OUTDOOR	DDL-56L-4K-1-NA	52	HUBBELL OUTDOOR
4041	16	HUBBELL OUTDOOR	BOI-04	30	HUBBELL OUTDOOR	DDL-9L1	52	HUBBELL OUTDOOR
4041	21	HUBBELL OUTDOOR	BOS-01	30	HUBBELL OUTDOOR	DDL-DRIVER-120V	52,53	HUBBELL OUTDOOR
4090	21	HUBBELL OUTDOOR	BOS-02	30	HUBBELL OUTDOOR	DDL-DRIVER-140	52	HUBBELL OUTDOOR
705327	17	HUBBELL OUTDOOR	BOS-04	30	HUBBELL OUTDOOR	DDL-DRIVER-56	52	HUBBELL OUTDOOR
93023491	52	HUBBELL OUTDOOR	BR-GX	30	HUBBELL OUTDOOR	DDL-LENS	53	HUBBELL OUTDOOR
93048453	40	HUBBELL OUTDOOR	BR-SX	30	HUBBELL OUTDOOR	DDL-LENS-140	52	HUBBELL OUTDOOR
95005520	40	HUBBELL OUTDOOR	BRF-01	30	HUBBELL OUTDOOR	DDL-LENS2	52	HUBBELL OUTDOOR
20750110214	17	HUBBELL OUTDOOR	BRF-02	30	HUBBELL OUTDOOR	DDL-LENS2	53	HUBBELL OUTDOOR
26100119905	17	HUBBELL OUTDOOR	BRF-04	30	HUBBELL OUTDOOR	DDL-LENS5	52	HUBBELL OUTDOOR
26100149902	17	HUBBELL OUTDOOR	BRI-01	30	HUBBELL OUTDOOR	DDL-LENS5	53	HUBBELL OUTDOOR
26401839805	17	HUBBELL OUTDOOR	BRI-02	30	HUBBELL OUTDOOR	DDL-REFR	52	HUBBELL OUTDOOR
26401849803	17	HUBBELL OUTDOOR	BRI-04	30	HUBBELL OUTDOOR	DDL-REFR	53	HUBBELL OUTDOOR
80021660108	17	HUBBELL OUTDOOR	BRLU-01	30	HUBBELL OUTDOOR	DDL9L1NANPC8C	53	HUBBELL OUTDOOR
80033990104	34	HUBBELL OUTDOOR	BRLU-04	30	HUBBELL OUTDOOR	DDR-5AP	54	HUBBELL OUTDOOR
80033990104	35	HUBBELL OUTDOOR	BRS-01	30	HUBBELL OUTDOOR	DDR100S	54	HUBBELL OUTDOOR
103-7	60	HUBBELL OUTDOOR	BRS-02	30	HUBBELL OUTDOOR	DDR150S	54	HUBBELL OUTDOOR
103-71	60	HUBBELL OUTDOOR	BRS-04	30	HUBBELL OUTDOOR	DDS-100P	54	HUBBELL OUTDOOR
103-72	60	HUBBELL OUTDOOR	BUL	11	HUBBELL OUTDOOR	DDS-100PL	54	HUBBELL OUTDOOR
103-73	60	HUBBELL OUTDOOR	C-5	60	HUBBELL OUTDOOR	DDS-100S	54	HUBBELL OUTDOOR
103-74	60	HUBBELL OUTDOOR	C-5	61	HUBBELL OUTDOOR	DDS-150S	54	HUBBELL OUTDOOR
1031-3	60	HUBBELL OUTDOOR	CB-150	57-58	HUBBELL OUTDOOR	DDS-65F	54	HUBBELL OUTDOOR
1031-3	61	HUBBELL OUTDOOR	CB-75	57-58	HUBBELL OUTDOOR	DDS-70S	54	HUBBELL OUTDOOR
1031-3	62	HUBBELL OUTDOOR	CCEDG	73	COMPASS	EL-AB	57-58	HUBBELL OUTDOOR
1052-C	60	HUBBELL OUTDOOR	CCEDGE	73	COMPASS	EL-PT	57-58	HUBBELL OUTDOOR
1306C	60	HUBBELL OUTDOOR	CCEDR	73	COMPASS	F-042F8	12	HUBBELL OUTDOOR
1414-BOX	62	HUBBELL OUTDOOR	CCEDRE	73	COMPASS	F-050H1	12	HUBBELL OUTDOOR
200-0180-9904	34	HUBBELL OUTDOOR	CCESG	73	COMPASS	F-070H1	12	HUBBELL OUTDOOR
206-BC3	62	HUBBELL OUTDOOR	CCESGE	73	COMPASS	F-070S1	12	HUBBELL OUTDOOR
206-BC3-B	62	HUBBELL OUTDOOR	CCESR	73	COMPASS	F-100H1	12	HUBBELL OUTDOOR
207-5011-0222	63	HUBBELL OUTDOOR	CCESRE	73	COMPASS	F-150S1	12	HUBBELL OUTDOOR
207-5011-0264	60	HUBBELL OUTDOOR	CCG	72	COMPASS	FL-AB	57-58	HUBBELL OUTDOOR
241-C-XX	21	HUBBELL OUTDOOR	CCGB	72	COMPASS	FLL-28L	6	HUBBELL OUTDOOR
264 0097 9702	61	HUBBELL OUTDOOR	CCGRC	72	COMPASS	FML-14	5	HUBBELL OUTDOOR
264 0097 9702	63	HUBBELL OUTDOOR	CCR	72	COMPASS	FML-14-PC1	5	HUBBELL OUTDOOR
264-0225-9904	42	HUBBELL OUTDOOR	CCRB	72	COMPASS	FSL-7	4	HUBBELL OUTDOOR
308-13-M	61	HUBBELL OUTDOOR	CCRRC	72	COMPASS	FSL-7-PC1	4	HUBBELL OUTDOOR
309-13-ML	61	HUBBELL OUTDOOR	CCRRCB	72	COMPASS	FXL-56L	7	HUBBELL OUTDOOR
309-14-ML	61	HUBBELL OUTDOOR	CEG	74	COMPASS	GN-AB	57-58	HUBBELL OUTDOOR
309-7P	63	HUBBELL OUTDOOR	CEGB	74	COMPASS	GN-PT	57-58	HUBBELL OUTDOOR
309-8P	63	HUBBELL OUTDOOR	CEGRC	74	COMPASS	GSL-15L	40	HUBBELL OUTDOOR
309-M51-ML	61	HUBBELL OUTDOOR	CEL1R1GNE	75	COMPASS	GSL-21L	40	HUBBELL OUTDOOR
309-M54-ML	61	HUBBELL OUTDOOR	CEL1R1RNE	75	COMPASS	GSL-CS	40	HUBBELL OUTDOOR
309-ML	61	HUBBELL OUTDOOR	CEL2G2GNE	75	COMPASS	GSL-LENS-M	40	HUBBELL OUTDOOR
309-S	61	HUBBELL OUTDOOR	CEL2R2RNE	75	COMPASS	GSL-LENS-R	40	HUBBELL OUTDOOR
309-S	63	HUBBELL OUTDOOR	CELS1GNE	75	COMPASS	GSL-MTG-PL	40	HUBBELL OUTDOOR
309-VG-ML	61	HUBBELL OUTDOOR	CELS1RNE	75	COMPASS	GSL-Protector	40	HUBBELL OUTDOOR
30910LEDML	61	HUBBELL OUTDOOR	CELS2GNE	75	COMPASS	GSL-SPC	40	HUBBELL OUTDOOR
4024C	16	HUBBELL OUTDOOR	CELS2RNE	75	COMPASS	HBL-48LU-5K-A-070-WH	64	HUBBELL INDUSTRIAL
4024C	21	HUBBELL OUTDOOR	CER	74	COMPASS	HBL-48LU-5K-N-070-WH	64	HUBBELL INDUSTRIAL
583-G	59	HUBBELL OUTDOOR	CERB	74	COMPASS	HBL-48LU-5K-W-070-WH	64	HUBBELL INDUSTRIAL
583M-VG	59	HUBBELL OUTDOOR	CERRC	74	COMPASS	HBL-60LU-5K-A-070-WH	64	HUBBELL INDUSTRIAL
800-3289-0100	43	HUBBELL OUTDOOR	CERRCB	74	COMPASS	HBL-60LU-5K-N-070-WH	64	HUBBELL INDUSTRIAL
ALF-12LU-5K-BZ	10	HUBBELL OUTDOOR	CEWDGE	76	COMPASS	HBL-60LU-5K-W-070-WH	64	HUBBELL INDUSTRIAL
ALF-6LU-5K-BZ	10	HUBBELL OUTDOOR	CEWDRE	76	COMPASS	HBL-72LU-5K-A-070-WH	64	HUBBELL INDUSTRIAL
ALFW-6LU-5K-BZ	10	HUBBELL OUTDOOR	CEWSGE	76	COMPASS	HBL-72LU-5K-N-070-WH	64	HUBBELL INDUSTRIAL
ALFW-6LU-5K-BZ-PC	10	HUBBELL OUTDOOR	CEWSRE	76	COMPASS	HBL-72LU-5K-W-070-WH	64	HUBBELL INDUSTRIAL
ARM-16-1	51	HUBBELL OUTDOOR	CIRD	77	COMPASS	LB6LEDA10L	71	PRESCOLITE
ARM-16-3	51	HUBBELL OUTDOOR	CIRS	77	COMPASS	LB6LEDA8L	71	PRESCOLITE
ARM-DD24	50	HUBBELL OUTDOOR	CO-AB	57-58	HUBBELL OUTDOOR	LBSLEDA10L	69	PRESCOLITE
ARM-DD24	51	HUBBELL OUTDOOR	CO-AG	57-58	HUBBELL OUTDOOR	LBSQLEDA10L	69	PRESCOLITE
ARM-DD30	50	HUBBELL OUTDOOR	CORD	78	COMPASS	LNC-5LU-5K	24	HUBBELL OUTDOOR
ARM-DD30	51	HUBBELL OUTDOOR	CORS	78	COMPASS	LNC-5LU-5K-PC	24	HUBBELL OUTDOOR
BL-400P-HB	66	HUBBELL INDUSTRIAL	CSREIV	81	COMPASS	LNC-7LU	24	HUBBELL OUTDOOR
BL-400P-HB-Q	66	HUBBELL INDUSTRIAL	CSRV	81	COMPASS	LNC-9LU	24	HUBBELL OUTDOOR
BL-400P-LB-EX	66	HUBBELL INDUSTRIAL	CU2	79	COMPASS	LNC2-12LU-5K-3-1	25	HUBBELL OUTDOOR

UNC2-18LU-5K-3-1	25	HUBBELL OUTDOOR
UNC2-7LU-5K	25	HUBBELL OUTDOOR
UNC2-9LU-5K	25	HUBBELL OUTDOOR
LR-30	21	HUBBELL OUTDOOR
LVT56	57-58	HUBBELL OUTDOOR
M2LH	20	HUBBELL OUTDOOR
MHK-0400P-338	15	HUBBELL OUTDOOR
MHK-0400P-368	15	HUBBELL OUTDOOR
MHK-0400S-238	15	HUBBELL OUTDOOR
MHK-0400S-268	15	HUBBELL OUTDOOR
MHP-0400P-338	15	HUBBELL OUTDOOR
MHP-0400P-368	15	HUBBELL OUTDOOR
MHP-0400S-238	15	HUBBELL OUTDOOR
MHP-0400S-268	15	HUBBELL OUTDOOR
MHS-30L SERIES	8	HUBBELL OUTDOOR
MHS-K250P8	14	HUBBELL OUTDOOR
MHS-K400P8	14	HUBBELL OUTDOOR
MHS-Y150P8	14	HUBBELL OUTDOOR
MHS-Y150S8	14	HUBBELL OUTDOOR
MHS-Y250P8	14	HUBBELL OUTDOOR
MHS-Y250S8	14	HUBBELL OUTDOOR
MHS-Y400P5	14	HUBBELL OUTDOOR
MHS-Y400P8	14	HUBBELL OUTDOOR
MHS-Y400S5	14	HUBBELL OUTDOOR
MHS-Y400S8	14	HUBBELL OUTDOOR
MIC-0070H-358	13	HUBBELL OUTDOOR
MIC-0070S-651	13	HUBBELL OUTDOOR
MIC-0100H-358	13	HUBBELL OUTDOOR
MIC-0150P-338	13	HUBBELL OUTDOOR
MIC-0150P-358	13	HUBBELL OUTDOOR
MIC-0150S-258	13	HUBBELL OUTDOOR
MIC-0150S-651	13	HUBBELL OUTDOOR
MLED-40L SERIES	9	HUBBELL OUTDOOR
MLED-80L SERIES	9	HUBBELL OUTDOOR
MO	20	HUBBELL OUTDOOR
MO-W	20	HUBBELL OUTDOOR
MVK-0250P-268	15	HUBBELL OUTDOOR
MVK-0250S-268	15	HUBBELL OUTDOOR
MVK-0400P-268	15	HUBBELL OUTDOOR
MVK-0400S-268	15	HUBBELL OUTDOOR
MVK-1000H-268	15	HUBBELL OUTDOOR
MVM-0250P-268	15	HUBBELL OUTDOOR
MVM-0250S-268	15	HUBBELL OUTDOOR
MVM-0400P-268	15	HUBBELL OUTDOOR
MVM-0400S-268	15	HUBBELL OUTDOOR
MVM-1000H-268	15	HUBBELL OUTDOOR
MVM-HPS-SEA2	15	HUBBELL OUTDOOR
MVM-PCR	16	HUBBELL OUTDOOR
MVM-S2	16	HUBBELL OUTDOOR
MVM-V2	16	HUBBELL OUTDOOR
NM-BC	62	HUBBELL OUTDOOR
NM-BC	61	HUBBELL OUTDOOR
NRG-1111-B	27	HUBBELL OUTDOOR
NRG-1111-W	27	HUBBELL OUTDOOR
NRG-1112-B	27	HUBBELL OUTDOOR
NRG-1112-W	27	HUBBELL OUTDOOR
NRG-1143-W	27	HUBBELL OUTDOOR
NRG-1171-B	27	HUBBELL OUTDOOR
NRG-1171-W	27	HUBBELL OUTDOOR
NRG-1172-W	27	HUBBELL OUTDOOR
NRG-204B	38	HUBBELL OUTDOOR
NRG-204B-MS	38	HUBBELL OUTDOOR
NRG-204B-PC	38	HUBBELL OUTDOOR
NRG-206B-PC	38	HUBBELL OUTDOOR
NRG-250	38	HUBBELL OUTDOOR
NRG-250B-PC	38	HUBBELL OUTDOOR
NRG-301B	39	HUBBELL OUTDOOR
NRG-301B-PC	39	HUBBELL OUTDOOR
NRG-304B	39	HUBBELL OUTDOOR
NRG-304B-MS	39	HUBBELL OUTDOOR
NRG-304B-PC	39	HUBBELL OUTDOOR
NRG-304B-PCW	39	HUBBELL OUTDOOR
NRG-306B	39	HUBBELL OUTDOOR
NRG-306B-PC	39	HUBBELL OUTDOOR
NRG-306B-PCW	39	HUBBELL OUTDOOR
NRG-307B	39	HUBBELL OUTDOOR
NRG-307B-PC	39	HUBBELL OUTDOOR
NRG-311	33	HUBBELL OUTDOOR
NRG-312LU-5K-BZ	26	HUBBELL OUTDOOR
NRG-312LU-5K-BZ-PC	26	HUBBELL OUTDOOR
NRG-315	33	HUBBELL OUTDOOR
NRG-317	33	HUBBELL OUTDOOR
NRG-350B	39	HUBBELL OUTDOOR
NRG-350B-PC	39	HUBBELL OUTDOOR
NRG-401	42	HUBBELL OUTDOOR
NRG-406-2	42	HUBBELL OUTDOOR
NRG-413P8	43	HUBBELL OUTDOOR
NRG-413P8-WH	43	HUBBELL OUTDOOR
NRG-413S8	43	HUBBELL OUTDOOR
NRG-414S8	43	HUBBELL OUTDOOR
NRG-415P8	43	HUBBELL OUTDOOR
NRG-415P8-WH	43	HUBBELL OUTDOOR
NRG-456	42	HUBBELL OUTDOOR
NRG1100FHB	27	HUBBELL OUTDOOR
NRG1100FW	27	HUBBELL OUTDOOR
NRG1111FHB	27	HUBBELL OUTDOOR
NRG1111FW	27	HUBBELL OUTDOOR
NRG200BLENS	38	HUBBELL OUTDOOR
NRG4-30LU-4K-035-BZ	41	HUBBELL OUTDOOR
NRG4-30LU-4K-BZ	41	HUBBELL OUTDOOR
NRG4-30LU-5K-035-BZ	41	HUBBELL OUTDOOR
NRG4-30LU-5K-BZ	41	HUBBELL OUTDOOR
NV2AG	67	HUBBELL INDUSTRIAL
NV2BG	67	HUBBELL INDUSTRIAL
NV2CC	67	HUBBELL INDUSTRIAL
NV2CG	67	HUBBELL INDUSTRIAL
NV2FG13	67	HUBBELL INDUSTRIAL
NV2FG13AHG	67	HUBBELL INDUSTRIAL
NV2FG13ASG	67	HUBBELL INDUSTRIAL
NV2FG13BHG	67	HUBBELL INDUSTRIAL
NV2FG13BSG	67	HUBBELL INDUSTRIAL
NV2FG13XHG	67	HUBBELL INDUSTRIAL
NV2FG13XSG	67	HUBBELL INDUSTRIAL
NV2FG18	67	HUBBELL INDUSTRIAL
NV2FG18AHG	67	HUBBELL INDUSTRIAL
NV2FG18ASG	67	HUBBELL INDUSTRIAL
NV2FG18BHG	67	HUBBELL INDUSTRIAL
NV2FG18BSG	67	HUBBELL INDUSTRIAL
NV2FG18XHG	67	HUBBELL INDUSTRIAL
NV2FG18XSG	67	HUBBELL INDUSTRIAL
NV2FG26	67	HUBBELL INDUSTRIAL
NV2FG26AHG	67	HUBBELL INDUSTRIAL
NV2FG26ASG	67	HUBBELL INDUSTRIAL
NV2FG26BHG	67	HUBBELL INDUSTRIAL
NV2FG26BSG	67	HUBBELL INDUSTRIAL
NV2FG26XHG	67	HUBBELL INDUSTRIAL
NV2FG26XSG	67	HUBBELL INDUSTRIAL
NV2FG32	67	HUBBELL INDUSTRIAL
NV2FG32AHG	67	HUBBELL INDUSTRIAL
NV2FG32ASG	67	HUBBELL INDUSTRIAL
NV2FG32BHG	67	HUBBELL INDUSTRIAL
NV2FG32BSG	67	HUBBELL INDUSTRIAL
NV2FG32XHG	67	HUBBELL INDUSTRIAL
NV2FG32XSG	67	HUBBELL INDUSTRIAL
NV2FG42	67	HUBBELL INDUSTRIAL
NV2FG42AHG	67	HUBBELL INDUSTRIAL
NV2FG42ASG	67	HUBBELL INDUSTRIAL
NV2FG42BHG	67	HUBBELL INDUSTRIAL
NV2FG42BSG	67	HUBBELL INDUSTRIAL
NV2FG42XHG	67	HUBBELL INDUSTRIAL
NV2FG42XSG	67	HUBBELL INDUSTRIAL
NV2GG	67	HUBBELL INDUSTRIAL
NV2IG15	67	HUBBELL INDUSTRIAL
NV2IG15AHG	67	HUBBELL INDUSTRIAL
NV2IG15ASG	67	HUBBELL INDUSTRIAL
NV2IG15BHG	67	HUBBELL INDUSTRIAL
NV2IG15BSG	67	HUBBELL INDUSTRIAL
NV2IG15XHG	67	HUBBELL INDUSTRIAL
NV2IG15XSG	67	HUBBELL INDUSTRIAL
NV2XG	67	HUBBELL INDUSTRIAL
NVEXTG	67	HUBBELL INDUSTRIAL
NVPSD12	67	HUBBELL INDUSTRIAL
PBT-1	16	HUBBELL OUTDOOR
PBT-1	23	HUBBELL OUTDOOR
PBT-234	16	HUBBELL OUTDOOR
PBT-234	23	HUBBELL OUTDOOR
PG-PS	36	HUBBELL OUTDOOR
PG-WG	36	HUBBELL OUTDOOR
PGL-250P-128-1-LP	36	HUBBELL OUTDOOR
PGL-250S-128-1	36	HUBBELL OUTDOOR
PGL-320P-128-1	36	HUBBELL OUTDOOR
PGL-350P-128-1	36	HUBBELL OUTDOOR
PGL-350P-128-1-LP	36	HUBBELL OUTDOOR
PGL-400S-128-1	36	HUBBELL OUTDOOR
PGL-400S-128-1-LP	36	HUBBELL OUTDOOR
PGM3-070S-18-BZ	35	HUBBELL OUTDOOR
PGM3-100P-18-BZ-L	35	HUBBELL OUTDOOR
PGM3-100S-18-BZ	35	HUBBELL OUTDOOR
PGM3-150P-18-BZ	35	HUBBELL OUTDOOR
PGM3-150P-18-BZ-L	35	HUBBELL OUTDOOR
PGM3-150S-18-BZ	35	HUBBELL OUTDOOR
PGM3-150S-18-BZ-L	35	HUBBELL OUTDOOR
PGM3-250P-18-BZ	35	HUBBELL OUTDOOR
PGM3-250P-18-BZ-L	35	HUBBELL OUTDOOR
PGM3-250S-18-BZ	35	HUBBELL OUTDOOR
PGM3-250S-18-BZ-L	35	HUBBELL OUTDOOR
PGM3-30LU	32	HUBBELL OUTDOOR
PGM3-LB	35	HUBBELL OUTDOOR
PRR	23	HUBBELL OUTDOOR
PSC	23	HUBBELL OUTDOOR
PTA-1	23	HUBBELL OUTDOOR
PTA-1	40	HUBBELL OUTDOOR
PTA-5	23	HUBBELL OUTDOOR
PTA-8	23	HUBBELL OUTDOOR
PTA-8	40	HUBBELL OUTDOOR
PTL-1	23	HUBBELL OUTDOOR
PTL-5	23	HUBBELL OUTDOOR
PTL-6	23	HUBBELL OUTDOOR
PTL-8	23	HUBBELL OUTDOOR
PVL3-070P-18-BZ-L	34	HUBBELL OUTDOOR
PVL3-070S-18-BZ	34	HUBBELL OUTDOOR
PVL3-100P-18-BZ-L	34	HUBBELL OUTDOOR
PVL3-100S-18-BZ	34	HUBBELL OUTDOOR
PVL3-100S-18-BZ-L	34	HUBBELL OUTDOOR
PVL3-150P-18-BZ	34	HUBBELL OUTDOOR
PVL3-150P-18-BZ-L	34	HUBBELL OUTDOOR
PVL3-150S-18-BZ	34	HUBBELL OUTDOOR
PVL3-150S-18-BZ-L	34	HUBBELL OUTDOOR
PVL3-150S-51-BZ-L	34	HUBBELL OUTDOOR
PVL3-242F-18-BZ-L	34	HUBBELL OUTDOOR
PVL3-242F-18-BZ-L-2BOC	34	HUBBELL OUTDOOR
PVL3-30LU	32	HUBBELL OUTDOOR
PVL3V	36	HUBBELL OUTDOOR
Q-150-B	18	HUBBELL OUTDOOR
Q-150-W	18	HUBBELL OUTDOOR
Q-300-B	18	HUBBELL OUTDOOR
Q-300-W	18	HUBBELL OUTDOOR
Q-500-B	18	HUBBELL OUTDOOR
Q-500-W	18	HUBBELL OUTDOOR
QL-1505	17	HUBBELL OUTDOOR
QL-15G	17	HUBBELL OUTDOOR
QL-15V	17	HUBBELL OUTDOOR
QL-505	17	HUBBELL OUTDOOR
QL-505-BZ	17	HUBBELL OUTDOOR
QL-5G	17	HUBBELL OUTDOOR
QL-TB	17	HUBBELL OUTDOOR
QL-VS	17	HUBBELL OUTDOOR
QL-VS	17	HUBBELL OUTDOOR
QWL-1000T	19	HUBBELL OUTDOOR

# INDEX

## Product Index

INDEX

QWL-150C	19	HUBBELL OUTDOOR
QWL-500S	19	HUBBELL OUTDOOR
R12-100H	44	HUBBELL OUTDOOR
R2LHQ	20	HUBBELL OUTDOOR
R2LHQW	20	HUBBELL OUTDOOR
R9-42F	44	HUBBELL OUTDOOR
R9-70H	44	HUBBELL OUTDOOR
R9-70S	44	HUBBELL OUTDOOR
RA-4P-M51-W	51	HUBBELL OUTDOOR
RA-4P-M53-W	51	HUBBELL OUTDOOR
RA-6P-M51-W	51	HUBBELL OUTDOOR
RA-6P-M53-W	51	HUBBELL OUTDOOR
RD-AB	57-58	HUBBELL OUTDOOR
RE-PT	57-58	HUBBELL OUTDOOR
RL-60LU-3K	48	HUBBELL OUTDOOR
RL-60LU-4K	48	HUBBELL OUTDOOR
RL-60LU-5K	48	HUBBELL OUTDOOR
RLC-3-1	49	HUBBELL OUTDOOR
RLC-3-3	49	HUBBELL OUTDOOR
RLD-25S35-1	49	HUBBELL OUTDOOR
RLD-25S35-3	49	HUBBELL OUTDOOR
RLD-25S38-1	49	HUBBELL OUTDOOR
RLD-25S38-3	49	HUBBELL OUTDOOR
RLD-40P35-1	49	HUBBELL OUTDOOR
RLD-40P35-3	49	HUBBELL OUTDOOR
RLD-40P38-1	49	HUBBELL OUTDOOR
RLD-40P38-3	49	HUBBELL OUTDOOR
RLD-40S35-1	49	HUBBELL OUTDOOR
RLD-40S35-3	49	HUBBELL OUTDOOR
RLD-40S38-1	49	HUBBELL OUTDOOR
RLD-40S38-3	49	HUBBELL OUTDOOR
RM-30LU-3K	47	HUBBELL OUTDOOR
RM-30LU-4K	47	HUBBELL OUTDOOR
RM-30LU-5K	47	HUBBELL OUTDOOR
RMA-3-1	50	HUBBELL OUTDOOR
RMA-3-3	50	HUBBELL OUTDOOR
RMC-3-1	50	HUBBELL OUTDOOR
RMC-3-3	50	HUBBELL OUTDOOR
RMD-07S25-1	50	HUBBELL OUTDOOR
RMD-07S25-3	50	HUBBELL OUTDOOR
RMD-07S28-1	50	HUBBELL OUTDOOR
RMD-07S28-3	50	HUBBELL OUTDOOR
RMD-10S25-1	50	HUBBELL OUTDOOR
RMD-10S25-3	50	HUBBELL OUTDOOR
RMD-10S28-1	50	HUBBELL OUTDOOR
RMD-10S28-3	50	HUBBELL OUTDOOR
RMD-15P35-1	50	HUBBELL OUTDOOR
RMD-15P35-3	50	HUBBELL OUTDOOR
RMD-15P38-1	50	HUBBELL OUTDOOR
RMD-15P38-3	50	HUBBELL OUTDOOR
RMD-15S25-1	50	HUBBELL OUTDOOR
RMD-15S25-3	50	HUBBELL OUTDOOR
RMD-15S28-1	50	HUBBELL OUTDOOR
RMD-15S28-3	50	HUBBELL OUTDOOR
RMD-25P35-1	50	HUBBELL OUTDOOR
RMD-25P35-3	50	HUBBELL OUTDOOR
RMD-25P38-1	50	HUBBELL OUTDOOR
RMD-25P38-3	50	HUBBELL OUTDOOR
RMD-25S35-1	50	HUBBELL OUTDOOR
RMD-25S35-3	50	HUBBELL OUTDOOR
RMD-25S38-1	50	HUBBELL OUTDOOR
RMD-25S38-3	50	HUBBELL OUTDOOR
RMG-3-1	50	HUBBELL OUTDOOR
RMG-3-3	50	HUBBELL OUTDOOR
S-302	17	HUBBELL OUTDOOR
S-302	62	HUBBELL OUTDOOR
S-302-M51	17	HUBBELL OUTDOOR
S-302-M51	62	HUBBELL OUTDOOR
S-302-M52	62	HUBBELL OUTDOOR
S-307	60	HUBBELL OUTDOOR
S-314-B	62	HUBBELL OUTDOOR
S-319-B	42	HUBBELL OUTDOOR
S-319-B	61	HUBBELL OUTDOOR
S-329-B	60	HUBBELL OUTDOOR

S-329-B	61	HUBBELL OUTDOOR
S12-100H	45	HUBBELL OUTDOOR
S12-150P	45	HUBBELL OUTDOOR
S2LH	20	HUBBELL OUTDOOR
S2LH-W	20	HUBBELL OUTDOOR
S329B	59	HUBBELL OUTDOOR
S9-42F	45	HUBBELL OUTDOOR
S9-70H	45	HUBBELL OUTDOOR
SCP-REMOTE	40	HUBBELL OUTDOOR
SM009-LENS	45	HUBBELL OUTDOOR
SM012-LENS	45	HUBBELL OUTDOOR
SM020-LENS	44	HUBBELL OUTDOOR
SM021-LENS	44	HUBBELL OUTDOOR
SM106-FRAME/GLASS	37	HUBBELL OUTDOOR
SM106-GUARD	37	HUBBELL OUTDOOR
SM106-SHIELD	37	HUBBELL OUTDOOR
SM106-visor	37	HUBBELL OUTDOOR
SM352-COVER	30	HUBBELL OUTDOOR
SM352-COVER	39	HUBBELL OUTDOOR
SM704-FRAME/GLASS	37	HUBBELL OUTDOOR
SM704-GUARD	37	HUBBELL OUTDOOR
SM704-REPLGL	37	HUBBELL OUTDOOR
SM704-shield	37	HUBBELL OUTDOOR
SM705-LENS	37	HUBBELL OUTDOOR
SM708-FRAME/GLASS	37	HUBBELL OUTDOOR
SM708-GUARD	37	HUBBELL OUTDOOR
SM708-REPLGL	37	HUBBELL OUTDOOR
SM708-visor	37	HUBBELL OUTDOOR
SM765-frame/GLASS	28	HUBBELL OUTDOOR
SM765-GLASS	28	HUBBELL OUTDOOR
SO	20	HUBBELL OUTDOOR
SO-W	20	HUBBELL OUTDOOR
SS-AB	57-58	HUBBELL OUTDOOR
SS-AG	57-58	HUBBELL OUTDOOR
SSB-21-M51	22	HUBBELL OUTDOOR
SSB-31-M51	22	HUBBELL OUTDOOR
SSB-41-M51	22	HUBBELL OUTDOOR
SSB-43-M51	22	HUBBELL OUTDOOR
TCB-1	21	HUBBELL OUTDOOR
TCB-2	21	HUBBELL OUTDOOR
TCB-3	21	HUBBELL OUTDOOR
THB-21	22	HUBBELL OUTDOOR
THB-21-M53	22	HUBBELL OUTDOOR
THB-31	22	HUBBELL OUTDOOR
THB-32	22	HUBBELL OUTDOOR
THB-41	22	HUBBELL OUTDOOR
THB-43	22	HUBBELL OUTDOOR
TPR-2	21	HUBBELL OUTDOOR
TPR-3	21	HUBBELL OUTDOOR
TPR-4	21	HUBBELL OUTDOOR
TWK-11	16	HUBBELL OUTDOOR
TWK-11	21	HUBBELL OUTDOOR
UCT-1	46	HUBBELL OUTDOOR
UCT-2	46	HUBBELL OUTDOOR
UCT-3	46	HUBBELL OUTDOOR
UCT-4	46	HUBBELL OUTDOOR
UCT-5	46	HUBBELL OUTDOOR
UCT-6	46	HUBBELL OUTDOOR
UCT-7	46	HUBBELL OUTDOOR
UCT-8	46	HUBBELL OUTDOOR
UCT-9	46	HUBBELL OUTDOOR
VAMG-100	56	HUBBELL OUTDOOR
VAMG-100	67	HUBBELL INDUSTRIAL
VAMG-200	56	HUBBELL OUTDOOR
VBG-100	56	HUBBELL OUTDOOR
VBG-1001	67	HUBBELL INDUSTRIAL
VBG-200	56	HUBBELL OUTDOOR
VBG-150	56	HUBBELL OUTDOOR
VBG-300	56	HUBBELL OUTDOOR
VBGL-1	55	HUBBELL OUTDOOR
VBGP-100	56	HUBBELL OUTDOOR
VBGP-100	67	HUBBELL INDUSTRIAL
VCGP-100	56	HUBBELL OUTDOOR
VCGP-100	67	HUBBELL INDUSTRIAL

VCGP-200	56	HUBBELL OUTDOOR
VCGPT-100	56	HUBBELL OUTDOOR
VCGPT-100	67	HUBBELL INDUSTRIAL
VG-15	56	HUBBELL OUTDOOR
VG-15	67	HUBBELL INDUSTRIAL
VG-30	56	HUBBELL OUTDOOR
VGG-100	56	HUBBELL OUTDOOR
VGG-100	67	HUBBELL INDUSTRIAL
VGG-200	56	HUBBELL OUTDOOR
VGGP-100	56	HUBBELL OUTDOOR
VGGP-100	67	HUBBELL INDUSTRIAL
VGGP-200	56	HUBBELL OUTDOOR
VGL-BU	55	HUBBELL OUTDOOR
VGL-FG	55	HUBBELL OUTDOOR
VGL-GN	55	HUBBELL OUTDOOR
VGL-GUARD	55	HUBBELL OUTDOOR
VGL-RD	56	HUBBELL OUTDOOR
VGL-YW	55	HUBBELL OUTDOOR
VPG-100	56	HUBBELL OUTDOOR
VPG-100	67	HUBBELL INDUSTRIAL
VPLGC-100	67	HUBBELL INDUSTRIAL
VRG-100	56	HUBBELL OUTDOOR
VRG-100	67	HUBBELL INDUSTRIAL
VRG-200	56	HUBBELL OUTDOOR
VRGP-100	56	HUBBELL OUTDOOR
VRGP-100	56	HUBBELL OUTDOOR
VRGP-100	67	HUBBELL INDUSTRIAL
VRGP-100	67	HUBBELL INDUSTRIAL
VRSG-100	55	HUBBELL OUTDOOR
VRSG-100	67	HUBBELL INDUSTRIAL
VWGG-150	56	HUBBELL OUTDOOR
VWGL-1	55	HUBBELL OUTDOOR
WB-01A	51	HUBBELL OUTDOOR
WB-02S	51	HUBBELL OUTDOOR
WB-03S	51	HUBBELL OUTDOOR
WB-04A	51	HUBBELL OUTDOOR
WB-04S	51	HUBBELL OUTDOOR
WB-05A	51	HUBBELL OUTDOOR
WB-06S	51	HUBBELL OUTDOOR
WB-07A	51	HUBBELL OUTDOOR
WB-07S	51	HUBBELL OUTDOOR
WB-08S	51	HUBBELL OUTDOOR
WGC-100H	28	HUBBELL OUTDOOR
WGC-100S	28	HUBBELL OUTDOOR
WGC-42F	28	HUBBELL OUTDOOR
WGC-50H	28	HUBBELL OUTDOOR
WGC-70H	28	HUBBELL OUTDOOR
WGH-100H	37	HUBBELL OUTDOOR
WGH-110-4K-U-M	31	HUBBELL OUTDOOR
WGH-150P	37	HUBBELL OUTDOOR
WGH-150S	37	HUBBELL OUTDOOR
WGH-150S120	37	HUBBELL OUTDOOR
WGH-1LU-M	27	HUBBELL OUTDOOR
WGH-225L-4K-U-L	27	HUBBELL OUTDOOR
WGH-250P	37	HUBBELL OUTDOOR
WGH-250S	37	HUBBELL OUTDOOR
WGH-400P	37	HUBBELL OUTDOOR
WGH-400S	37	HUBBELL OUTDOOR
WGH-70H	37	HUBBELL OUTDOOR
WGH-84F-MS423	37	HUBBELL OUTDOOR
WGH-84F2	37	HUBBELL OUTDOOR
WIH-OM-480	16	HUBBELL OUTDOOR
WIH-OM-UNV	16	HUBBELL OUTDOOR
WMR-42F1-PC	31	HUBBELL OUTDOOR
WMR-70P6	31	HUBBELL OUTDOOR
WPH-100S	37	HUBBELL OUTDOOR
WPH-70S	37	HUBBELL OUTDOOR





## ExpressLine – ready to help you maximize sales

Hubbell Lighting's ExpressLine program offers high impact point-of-purchase product merchandise gondolas, literature, counter mats and counter displays to maximize your sales!

## Selling & Merchandising Tools

To drive incremental sales, ExpressLine members have use of our displays, gondola headers, and promotional materials.



Counter Displays & Application Guides

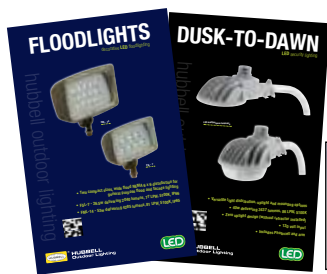

Posters, Counter Mats & Web based Design Application Tools



Contractor Reward Incentives





United States  
 Hubbell Lighting, Inc.  
 701 Millennium Boulevard  
 Greenville, SC 29607  
 www.hubbellighting.com

Canada  
 Hubbell Canada  
 870 Brock Road  
 Pickering, Ontario L1W 1Z8  
 www.hubbell-canada.com

Mexico  
 Hubbell De Mexico, S.A. DE CV  
 Av. Insurgentes Sur # 1228, 8th Floor  
 Col. Tlacoquemecatl del Valle • 03200 Mexico, D.F.  
 www.hubbell.com.mx

- ALERA LIGHTING
- ARCHITECTURAL AREA LIGHTING
- BEACON PRODUCTS
- COLUMBIA LIGHTING
- COMPASS PRODUCTS
- DEVINE LIGHTING
- DUAL-LITE
- HOMESTYLE LIGHTING
- HUBBELL BUILDING AUTOMATION
- HUBBELL INDUSTRIAL LIGHTING
- HUBBELL OUTDOOR LIGHTING
- KIM LIGHTING
- KURT VERSEN
- LITECONTROL
- PRESCOLITE
- PROGRESS LIGHTING
- SECURITY LIGHTING
- SPAULDING LIGHTING
- SPORTSLITER SOLUTIONS
- STERNER LIGHTING SYSTEMS
- WHITWAY



Due to our continued efforts to improve our products, product specifications are subject to change without notice.

