

Non-NEMA Twist-Lock® Devices
 30A, 250V DC Max. and 600V AC Max. 50- 400
 Hz 4 Pole, 5 Wire Grounding
 Variload® Connector

HUBBELL



Features

- Heat resistant thermoset construction
- Non-interchangeable center pin configuration to be designated to different circuits

Ordering Information

Description	Cord Diameter	UPC	Catalog Number
4P5W, 30A 600V AC Max, Non-NEMA, Black Nonmetallic Body	.625"-1.00" (15.9-25.4)	783585236582	HBL45335

Listings

Listed to UL 498
 Certified to CSA C22.2 No.42

Specifications

Housing	Molded Thermoset
Cover	Molded thermoset
Cord Clamp	Zinc Plated Steel
Contacts	Brass
Terminal Screw	Brass
Assembly Screws	Brass

Performance

Electrical	
Current Interrupting	Certified for current interrupting at full rated current
Dielectric Voltage	Withstands 2,000V minimum
Mechanical	
Terminal Accommodation	#14 AWG - #10 AWG stranded copper wire only.
Terminal Identification	Terminals identified in accordance with UL 498
Environmental	
Flammability	HB or better per UL 94 or CSA 22.2 No. 0.6
Operating Temperatures	Maximum Continuous 75°C; Minimum -40°C (w/o impact)

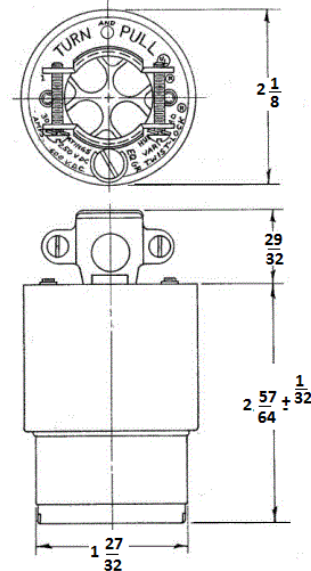

Accessories

Plug	HBL45315
Weatherproof Boot	HBL6028

Resources

Customer Use Drawing
 eCatalog

Dimensions in Inches (mm)

Hubbell Wiring Device-Kellems • Hubbell Incorporated (Delaware) • 40 Waterview Drive • Shelton, CT 06484

Phone (800) 288-6000 • Fax (800) 255-1031 • Specifications subject to change without notice.

