

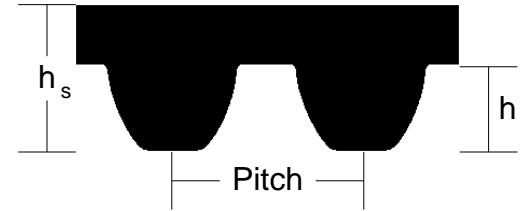

### Standard Construction Features

Belt Type: Synchronous  
 Core Material: Polyurethane  
 Cord/Tensile: Carbon  
 Jacket: Blue Nylon



### Belt Section Dimensions

Tooth Type	Pitch (mm)	$h_s$ (mm)	$h_t$ (mm)
GT	14.000	10.200	5.900

### Belt Dimensions

Pitch Length (mm)	No. Teeth	Width (mm)
1750.00 +0.860 -0.860	125	20.000 +0.600 -0.600

### Measuring Information

Y (mm)	T (N)	No. Teeth	O.D. (mm)	Pitch Circum. (mm)	Radial Runout (mm)	Axial Runout (mm)	PLD 2a (mm)
651.00 +0.430 +0.430	264	32	139.81	448.00	0.0005	0.0010	2.794

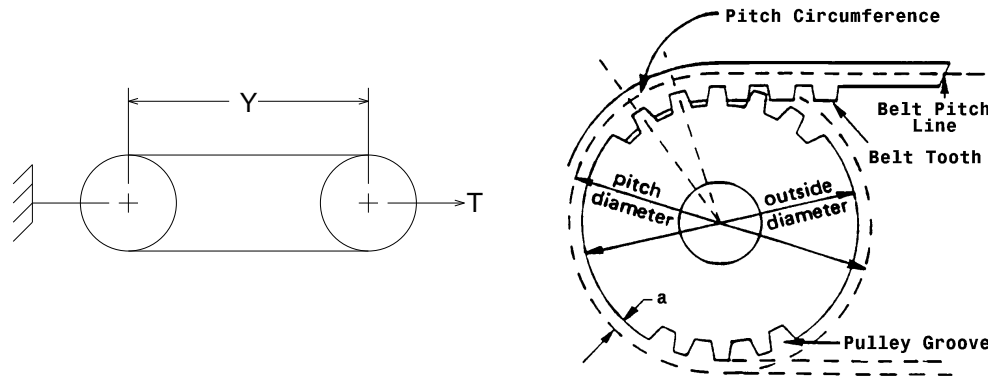

The length shall be measured by placing the belts on two pulleys of equal diameters that have been grooved in accordance with standard specifications and rotated at least three complete turns with the specified tension so that each strand receives half the total tension. The length will be that length obtained by adding the Pitch Circumference of one pulley to twice the center distance (dimension 'Y').



### DesignView™ Belt Information Sheet

Created 23 Jun 2017 by Gates

Created for

### Poly Chain GT Carbon - 14MGT

Gates Product Number

9274-4125

Customer Part Number

14MGT-1750-20