

Standard Construction Features

Belt Type: Synchronous
 Core Material: Polyurethane
 Cord/Tensile: Carbon
 Jacket: Blue Nylon

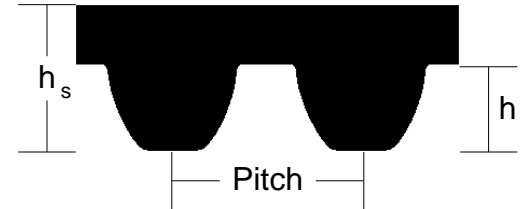

Belt Section Dimensions

Tooth Type	Pitch (mm)	h_s (mm)	h_t (mm)
GT	8.000	5.900	3.400

Belt Dimensions

Pitch Length (mm)	No. Teeth	Width (mm)
1120.00 +0.760 -0.760	140	62.000 +1.860 -1.860

Measuring Information

Y (mm)	T (N)	No. Teeth	O.D. (mm)	Pitch Circum. (mm)	Radial Runout (mm)	Axial Runout (mm)	PLD 2a (mm)
408.00 +0.380 +0.380	274	38	95.17	304.00	0.0005	0.0010	1.600

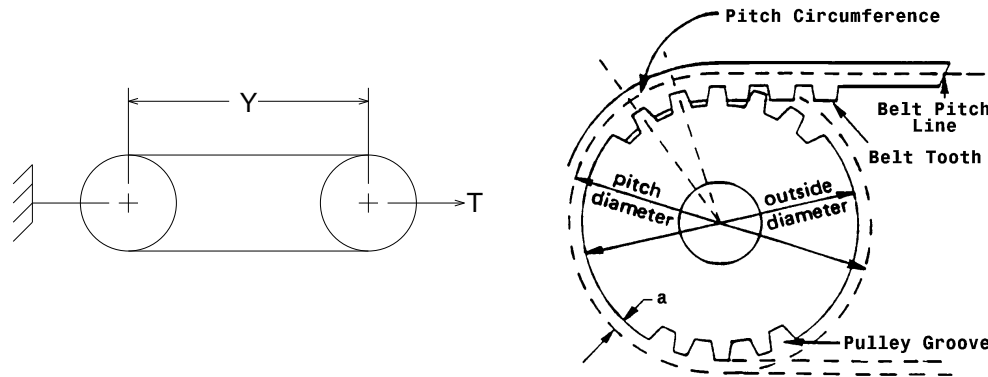

The length shall be measured by placing the belts on two pulleys of equal diameters that have been grooved in accordance with standard specifications and rotated at least three complete turns with the specified tension so that each strand receives half the total tension. The length will be that length obtained by adding the Pitch Circumference of one pulley to twice the center distance (dimension 'Y').



DesignView™ Belt Information Sheet

Created 23 Jun 2017 by Gates

Created for
Poly Chain GT Carbon - 8MGT

Gates Product Number
9274-3140

Customer Part Number
8MGT-1120-62