

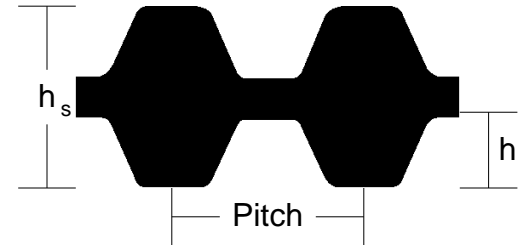

Standard Construction Features

Belt Type: Synchronous
 Core Material: Oil & Heat Resistant (chloroprene)
 Cord/Tensile: Fiberglass
 Jacket: Nylon



Belt Section Dimensions

Tooth Type	Pitch (in)	h_s (in)	h_t (in)
TRAP	3/8	0.180	0.075

Belt Dimensions

Pitch Length (in)	No. Teeth	Width (in)
36.75 +0.026 -0.026	98	0.500 +0.000 -0.000

Measuring Information

Y (in)	T (lbf)	No. Teeth	O.D. (in)	Pitch Circum. (in)	Radial Runout (in)	Axial Runout (in)	PLD 2a (in)
13.87 +0.013 +0.013	17	24	2.83	9.00	0.0005	0.0030	0.030

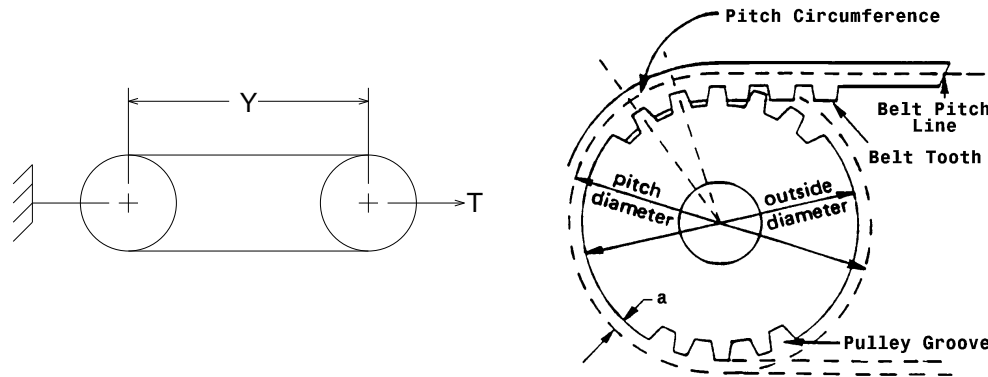

DesignView™ Belt Information Sheet

Created 28 Jun 2017 by Gates

Created for

PowerGrip Twin Power - TP-L

Gates Product Number

9246-2112

Customer Part Number

TP 367 L 050

The length shall be measured by placing the belts on two pulleys of equal diameters that have been grooved in accordance with standard specifications and rotated at least three complete turns with the specified tension so that each strand receives half the total tension. The length will be that length obtained by adding the Pitch Circumference of one pulley to twice the center distance (dimension 'Y').