

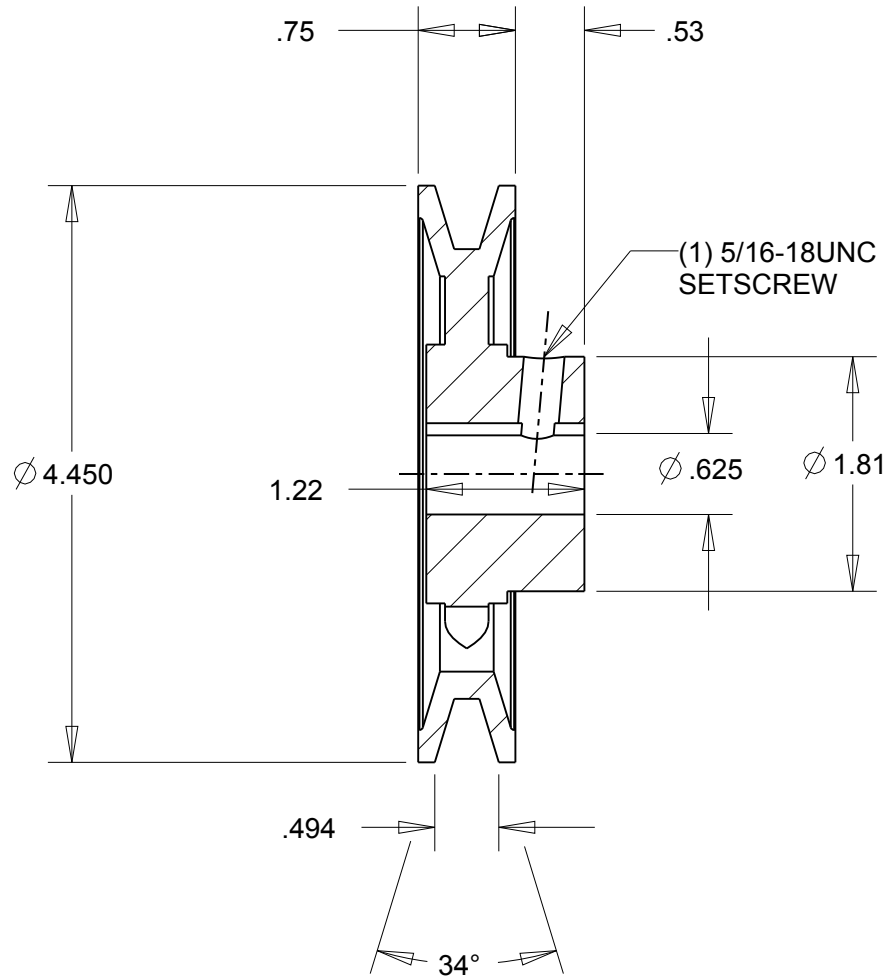

NOTES:

1. SURFACE FINISH PER MPTA B4
2. COATING: PAINT



DIMENSIONS ARE IN INCHES	 Gates Corporation Denver, Colorado
Material: IRON	Gates Part No: AK46.5/8
Finish: PAINT	Gates Product No: 78052193
Weight: 1.8	Drawing No: AK46.5/8

This drawing is a stock power transmission component. Details shown which do not affect drive function may be changed without any notification. This document is the property of Gates Corporation. It may not be reproduced in whole or in part or provided to third parties without written authorization from Gates Corporation. All rights are reserved including copyrights.