



2019

CATALOGUE

G HJUKSTROM LTD

Wholesale Automotive, Industrial & Hardware Products

19114-95A Avenue
Surrey, BC Canada
V4N 4P2

T: 604.882.8211

F: 604.882.9229

Toll Free Fax: 1.877.883.8833

E: sales@hjukstrom.com

www.hjukstrom.com

WINNIPEG BRANCH WAREHOUSE UNITED SALES ASSOCIATES

1510 Wall Street
Winnipeg, MB Canada
R3E 2S4

T: 204.694.3044

F: 204.694.1722

E: info@unitedsales.com

GH FACTORY SALES

A Division of G Hjukstrom Ltd

37 Fielding Avenue
Dartmouth, NS Canada
B3B 1E3

T: 902.468.1277

F: 902.468.1976

Toll Free Fax: 1.888.643.2211

E: sales@ghfactorysales.com

www.ghfactorysales.com

AUTOMOTIVE	1-30
HAND TOOLS	31-64
STRIKING TOOLS	65-82
BUILDERS & SECURITY	83-97
MATERIAL HANDLING	99-118
MISCELLANEOUS	119-130
SAFETY SUPPLIES	131-138
SPORTING GOODS	139-145

A Abrasives

- cup brushes 56
- cut off wheels 58
- flap discs 57
- grinding wheels 55-57
- sanding discs 55
- sanding pads 55
- wire wheels 55-57

Adhesives 24-30

Adjustable Wrenches 43

Adze 68

Air Hammer Kit 16

Alarm - Backup 14

Allencap Screw Asst. 119

Anchor Shackles 113, 114

Anchors – danforth & folding 145

Anti-Freeze Testers 9

Aquaseal 29

Auto Bulbs 1, 2

Axe Mate Protectors & Sheaths 65, 66, 70

Axes

- Agdor 66
- Beaver brand 68
- carpenters 65
- clearing 70
- competition 70
- double bit 66, 67, 68
- fire axes, spike 69
- hand forged 65, 66
- hatchets 65, 68, 69
- Hultafors 65, 66
- mauls 65, 67, 70
- miners 66, 68
- Oxhead Iltis 67
- Pulaski 69
- racing, competition 66, 67
- Unex brand 68-70

B Back-Up Alarm 14

Balaclavas 133

Ball Mount 20, 21

Barrel Bolts - Reg. & H.D. 92

Barricade

- fence 134
- tape 128

Bars

- crowbar 82
- prybar 82
- stripping 82
- Tove 81
- winch 116
- wrecking 82

Battery

- booster cables & clamps 12
- charger 10
- maintainers 10

- testers 9
- terminals and adapters 10, 11
- terminal brush 12

Bearings 109-111

Belt Punch Pliers 43

Benders

- pipe 38
- rebar 33

Binoculars 144

Blades

- band saw 61
- bow saw 58, 59
- circular saw 55
- hacksaw 61
- holesaw 59-60
- jig saw 61
- meat saw 59
- reciprocating 62
- utility knife 50
- wiper 15

Blocks

- cable 108, 109
- chain 106
- pillow blocks 109
- rope 108
- snatch, yarding 109

Boat Winches, cable strap 19

Bolt Cutters and Parts, MCC 32-34

Booster Cables & Clamps 12

Boots, rubber 134

Bow Saws and Blades 58, 59

Brass and Stainless Snare Wire 127

Brooms 120-124

Brush Hooks 68

Brushes

- angle 120
- battery terminal 12
- boat 123
- braces 122
- car 15
- corn 120
- counter 124
- cup brushes 56
- deck 123
- handles 125
- paint 129
- parts cleaning 130
- rig 124
- roof and tar 123
- scratch 130
- scrub 124
- wash 123
- whisk 120
- wire brushes 130

Brush-On Electrical Tape 29

Bulbs

- auto, motorcycle, snowmobile . . 1, 2
- work 126

Bungee Cords 23



INDEX

C Cable	– accessories	107	Cotter Pin Assortment	119	
	– aircraft	107	Coveralls – Disposable	128	
	– clips	107	Crow Bars – chisel and wedge point	82	
	– cutters	33, 34	Cup Brushes	56	
	– pullers	106	Cut-Off Wheels	58	
	– sheaves	109	Cutters	– bolt	32-34
	– sleeves	107		– hydraulic hose	33
	– stops	107		– pipe, PVC	34, 37
	– thimbles	107		– rebar	33
	– ties (white & black nylon)	13, 120		– steel strap	33
Calipers – dial, digital, vernier		63, 64		– threaded rod cutters	33
Cargo Lashes				– tubing	35, 37
	– cargo lash ratchets	24		– wire cutters	32
	– net	24		– wire rope	33, 34
Cash Boxes		96	Cylinder guards	89, 90	
Casters		22, 102	Cylinders	– dummy	89
Caulking Guns		48		– guard rings	89
Chain		118		– hydraulic	100, 101
	– zinc grade 30	118		– mortise	89
	– galvanized 30	118		– space rings	89
	– grade 70	118		– thumb turns	89
Chain Blocks		106	D Dead Blow Hammers	74	
Chain Accessories			Dead Bolts & Latches	87, 88	
	– cold shuts	113	Deburring Set	38	
	– hooks	107, 115	Dial Gauge	64	
	– lap links	113	Digital Safes	96	
	– link locks	113	Disposable	– coveralls	128
	– quick links	112		– gloves	131
	– “S” hooks	112	Door Pulls	– closers	91
Chain Saw Files		54, 55		– locks	87, 88
	– handles	53	Draw	– bar	21
Chain Vises		37		– knife	68
Chain Wrenches		36, 37	Drill Bits	– jobbers	53
Chalk lines		62		– prentice	53
Chalk refills		62		– sets	53
Channellock Pliers		40-42		– stub	53
Chemicals		24-30	Drill Press Vises	31	
Chisel and Punch Sets		45	Drywall Screw Bit	46	
Circular Saw Blades		55	Duct Tape	28, 127	
Clamps	– battery booster cable	12	Dust Masks	135	
	– C-clamps	31	Dust Pans	124	
	– hose	17, 18	E E-Clip Assortment	119	
Cleaners – hand		129	Electrical Connectors & Adapters (Auto)	10, 11, 13, 14	
Clearance & Marker Lights		5, 6	Electrical Tape	– brush on	29
Clearing Axe		70		Electricians Knife	49
Cleavis Pin Assortment		119		Electronic Safes	96
Cluthe	– funnels	103, 104		Emergency Lights	7, 8
	– measuring containers	104		Engine Stands	19, 20
	– measuring scoops	104		Epoxy Kits	74
Cold Shuts		113		Electrical Essential Kits	13, 14
Combination Wrench – Sets		44			
Compression & Vacuum Testers		9			
Concrete Wire Nippers		36, 41			
Connector Kits		13			
	– butt	13			
	– insulated ring	14			



Electrical Extension Cords	126, 127		
Electrical Plugs & Connectors	127		
Extractors – screw	53		
Eye Bolts	114		
F			
Fastener Assortments	119		
Fence			
– pliers	42		
– safety	134		
FiberFix	28		
File Card	129		
Files			
– axe	54		
– chain saw	54		
– file card	129		
– handles	54, 55		
– machinist	54, 55		
– mower	54		
– rasps	55		
Fire Axes, pulaski, spike	69		
Fire Starter	144		
Flagging Tape	128		
Flanges	110		
Flap Discs	57		
Flare Kits – plumbing	35		
Flashlights			
– head mounted	3		
– LED aluminum	3		
– lantern, camping	3		
Flush Bolts	88		
Forks	77		
Funnels	102, 103		
Fuses – auto	13		
G			
Gasket Making Silicones	27		
Gauges			
– auto	8		
– tire pressure	16		
Gear Pullers			
– two and three jaw	31		
Glasses	136, 137		
Gloves			
– disposable latex, nitrile	131		
– general purpose	131		
– mechanics	131		
– nitrile	133		
– welders	132		
– work	132, 133		
Glue	26, 28		
GOJO – hand cleaner wipes	129		
Goop	29, 30		
Grease Guns and Accessories	104		
Grease Nipples	119		
Gun Locks	144		
H			
Hacksaws and Blades	59, 61		
Hair Pins	112, 119		
Hammer Locks	113		
Hammers			
– blacksmith, club	72		
– brass, non-sparking	73		
– carpenters claw	73		
– deadblow	74		
– machinist (ball pein)	72, 73		
– rubber	74		
– sledge	71-73		
Hand Cleaner, GoJo	129		
Handles			
– broom	125		
– lever door	87, 89		
– push paddle door	88		
Handles, Striking Tool			
– adze	76		
– axe	65, 74, 75		
– fibreglass	74		
– file	53		
– hammer	75, 76		
– hatchet	65, 75		
– hookaroon	76		
– Hultafors	65		
– maul	65, 76		
– pick	76		
– post maul	72, 76		
– pulaski	75		
– scraper	71		
– shovel	76		
– sledge	75		
Hasps – safety	92		
Hatchets	65, 68, 69		
Hearing Protectors, Ear Plugs	135, 136		
Heat Shrink	135, 136		
Helmets			
– motorcycle	138		
– off-road	137		
– snowmobile	138		
Hex Key Sets	45		
Hi Lift Jacks	18		
Hinges			
– butt	91		
– strap	92		
– T-hinge	92		
Hitch Pins & Clips	111, 112		
Hoists			
– cable	106		
– chain, lever blocks	106		
– rope	106		
Holesaws	59, 60		
Hookaroons	69		
Hooks			
– clevis and eye	107, 115		
– carabiner	92, 115		
– garb	115		
– “S” hooks	112		
– safety	116		
– slip	107, 115		
– snap	116, 117		
– spring	115		
Hose			
– clamps	17, 18		
– cutters	33		



INDEX

- Hydraulic Cylinders 100, 101
- Hydraulic Hose Cutters 33
- Hydraulic Jacks 99
- Hydraulic Pipe Bender 38
- Hydraulic Pumps 101
- I** Ice Scrapers & Snow Brushes 15
- Impact Screwdriver 46
- Implement Light 3
- Inspection Mirror 50
- Inter-lock Plates 90
- J** J-B Weld 24-28
- Jacks**
 - Hi-Lift jack & accessories 18
 - hydraulic bottle 99
 - hydraulic cylinders 100, 101
 - trailer & accessories 21
- Jack Stands 20
- Jig Saw Blades 61
- Job Box Caster Set 102
- K** Kevron Key Tags 94, 95
- Key Blanks 83-86
- Key Cabinets 95
- Key Caddy Starrett 92
- Key Tags and Key Accessories 92-95
- Knee Pads 133
- Knives**
 - boning 142
 - camping 139, 140
 - draw 68
 - electrician's 49
 - field dressing 142
 - fillet, fishing 141, 142
 - folding pocket 143
 - hunting 139-142
 - kitchen, commercial 141
 - machete 142
 - paring 143
 - rescue 140
 - roe 141
 - skinning 141, 142
 - utility 49, 50
- Knob Protectors 89
- L** Lap Links 113
- Latch Paddles 88
- Latch Protector 90, 91
- Latex Gloves - Disposable 131
- LED Clearance & Marker Lights 5, 6
- Letter & Number Stamps 46
- Levels 62
- Lever Guards 89
- Lever Handles 87
- Lights**
 - adaptors 10, 11
 - clearance & marker 5, 6
 - emergency 7, 8
 - flashlights 3
 - off-road 4
 - safety, flashing 7, 8
 - string 126
 - timing lights 8
 - towing 7
 - tractor LED, Halogen 3, 4
 - trailer lights 7
 - trouble 126
 - turn, stop, tail,
marker, clearance 6
 - work LED 4, 125
- Linch Pins 111, 112
- Link Locks 113
- Load Binders 116
- Locks**
 - deadbolts 87
 - electronic 88
 - entry, passage, privacy 86, 87
 - gun locks 144
 - padlocks 83-86
 - trailer 22
- Locking Grip & Clamping Pliers 43
- M** Machete 142
- Magnetic Base 64
- Magnetic Pick-Up Tool 50
- Magnetic Rare Earth 50
- Magnetic**
 - retriever 50
 - socket tray 51
 - sweeper 50
 - tool tray 51
 - tray 50, 51
- Mallet – rubber 74
- Marker Pole 136
- Mauls**
 - post 72
 - splitting 65, 67, 70
- Measuring Containers & Scoops 104
- Measuring Tools 63, 64
- Meat Saw & Blades 59
- Mechanics Creeper Stool 17
- Mechanics Glove 131
- Mechanics Vise 31
- Micrometer – outside 64
- Mirror – telescopic 50
- Mops yacht & handle 124
- Mortise – cylinders, thumb turns,
dummy cylinders 89
- Multi-Testers – digital 9
- N** Net – cargo net 24
- Number & Letter Stamps 46

O "O" Ring Kits – rubber	119	Pry Bars	82
Oilers and Accessories	104	Pulaski Fire Axes	69
P Paddles – push-pull	88	Pullers – cable	106
Padlocks and Key Blanks		– gear	31
– armoured	86	– lever chain	106
– brass	83-86	– ratchet	106
– disc style	86	– rope	106
– e-type	86	Pulley Yoke	107
– keyed alike	83-86	Pulleys – malleable iron	108
– keyed different	83-86	– stainless	108
– laminated	83, 84	Pump Oilers	104
– semi-assembled	85	Pumps – hydraulic hand	101
– weather resistant	84	– lever, rotary, syphon	105
Paint		– air, hand	16
– brushes	129	– submersible	105
Picks and Mattocks		– syphon	105
– handles	76	Punch and Chisel Sets	45
– heads only	79	Punch – pin	45
Pick-Up Tool	50	– revolving belt	43
Pillow Blocks – Bearings	109, 110	– wad punch	46
Pin Punch Set	45	PVC Pipe Cutter, MCC, Superego	34, 37
Pipe			
– benders	38	Q Quick Links – plated steel & stainless steel	112
– cutters, MCC, Super Ego	34, 37	Quick Pins	111
– threaders	38		
– vises	37	R Rain Suits	134
– wrenches, SuperEgo	35, 36	Rakes – bow	77
Pipe Tool		– plastic leaf	77
– parts	38, 39	– snow rake	80
Pliers		Ratchet Cable Puller	106
– box joint	36	Rebar Cutter – Bender	33
– concrete wire nippers	36	Rebar Wire	127
– diagonal cutters	41	Rescue Tools	42
– end nippers	36, 41	Retainer Ring Assortment	119
– fence	42	Rifle Scopes	144
– linesman	40	Ring Bolts	114
– locking clamp	43	Rings Welded	112
– locking grip	43	Rivets	47
– longnose	40	Rope Hoists	106
– mini	42	Rope Ratchet	106
– nut buster	40	Rubber Tie-Downs	22, 23
– parallel action cutting	43		
– rescue	42	S "S" Hooks	112
– revolving punch plier	43	Safes	96, 97
– sets, mini 5 pc	42	Safety – fence	134
– slip joint	40	– flashing emergency lights	7, 8
– snap ring	41, 42	– glasses and goggles	135-137
– tongue and groove	40	– hooks	112
– welders	41	– pins	112
– wire stripping	41, 42	– vests	135
Post Maul	72	Saws – bandsaw blades	62
Protectors		– bow saws and blades	58, 59, 61
– cylinders	89, 90	– circular saw blades	55
– deadbolt	90		
– knob	89, 90		
– latch	90, 91		
– lever	89		
Prentice Drills	53		



INDEX

- hacksaws & blades 58, 59, 61
 - handsaws 59
 - holesaws & arbors 59-61
 - jigsaw blades 61
 - meat saws & blades 59
 - pruning saw 58
 - reciprocating blades 62
 - Scoops – measuring 104
 - Scopes – rifle 144
 - Scrapers** – heavy duty cast 71
 - auto, ice 15
 - razor type 49
 - Scratch Brushes 130
 - Screwdrivers**
 - drywall screwdriver bit 46
 - impact 46
 - open stock 47
 - precision 46
 - sets 47
 - Screw Extractors
 - spiral & square 53
 - Seal-All 29
 - Shackles – anchor 113, 114
 - Sharpening**
 - steels 143
 - stone 143
 - wet stone 66
 - Sheaths Axe 65, 66, 70
 - Sheaves – Cast Iron 109
 - Shelf Brackets 96
 - Shock Cords 23
 - Shovels 78-80
 - Silicone Gasket Makers & Adhesives 24-30
 - Sledge Hammers & Hammers 71-74
 - Shoe Goo 30
 - Snaps**
 - bolt 117
 - bull 117
 - hooks 115, 116
 - leash 116
 - panic 117
 - swivel 116, 117
 - trigger 117
 - Snatch Blocks 109
 - Snap Ring Assortment 119
 - Snow Brush & Ice Scraper 15
 - Snow Fence 134
 - Snow Shovels & Pushers 79, 80
 - Sockets Sets – 3/4" drive 45
 - Spacer Rings 89
 - Splitting Mauls 65, 67, 70
 - Split Pin Assortment 119
 - Split Rings 93, 94
 - Spring Assortments 119
 - Spring Hooks – plated steel &
stainless steel 115
 - Squeegees 15, 125
 - Stamps – Number and Letter 46
 - Stands**
 - engine 19, 20
 - jack 20
 - Starrett 59-62
 - Steels - Sharpening 143
 - Stop, Turn & Tail Light 6
 - Strap Cutter 33
 - Strap Wrench 36
 - Stripping Bar 82
 - Stub Drills 53
 - Submersible Pumps 105
 - Suction Guns 104
 - SuperEgo 36-39
 - Swagger Tool 34
 - Swivels 114, 115, 117
- T** Tap & Die Sets 51, 52
- Tape**
 - barricade 128
 - brush-on electrical 29
 - duct 28, 127
 - flagging 128
 - packing 128
 - PVC electrical 127
 - reflective, trailer 128
 - reflective, pet solas 127
 - FiberFix 28
 - teflon 128
 - Tapes – measuring 63
 - Tarps, Blue, Camo, White 134
 - Teflon Tape 128
 - Test Equipment - Vacuum, Compression,
Pressure, Anti-Freeze,
& Battery 9, 10, 16
 - Threaded Rob Cutter 33
 - Threader Kits and Parts 38
 - Tie Downs**
 - cargo lashes 24
 - shock cord fabric covered 23
 - ratchet 24
 - rubber, Snappi-Hooker 22, 23
 - sport quick release 24
 - Tie Wire – dispenser 127
 - Timing Lights 8
 - Tin Snips 35
 - Tire Pressure Gauges 16
 - Tire Valve Stems 16
 - Toques and Balaclavas 133
 - Tove Bar 81
 - Tow Rope 23
 - Tow Straps– nylon 24
 - Towing Lights 7
 - Tractor Lights 3, 4
 - Trailer**
 - balls, couplers & bushings . . 20, 22
 - bearing kits 111
 - jacks & accessories 20-22

– light adaptors	10, 11		
– lighting kit	7		
– locks	22		
– tape, reflective	128		
Tramontina Knives	142		
Traffic Warning Triangles	135		
Trigger Locks	144		
Trimmer Line	77		
Trouble Lights	126		
Tube Cutters	35, 37		
Turn, Stop, Tail Light	6		
Turnbuckles	114		
Twist Drills & Kits	53		
U Utility Chain Wrench	36		
Utility Knives - Blades	49, 50		
V Valve Stems	16		
Vacuum Tester	9		
Vests - Traffic	135		
Vises – bench	31		
– drill-press	31		
– multi-purpose	31		
– pipe	37		
W Wad Punch Kits	46		
Waders Chest & Hip	145		
Wedges – plastic	70		
– splitting	71		
– wood and metal for axe handling	76		
Welded Steel Rings	112		
Welding Compound	25-27		
Welding Gloves	132		
Wheel Lug Nuts	16		
Winch Bar	116		
Winches – boat	19		
– electric 12V	19		
Wiper Blades	15		
Wire – black annealed tie wire	127		
– brass snare wire	127		
– dispenser	127		
Wire Nippers	36, 41		
Wire Rope	107		
– accessories	107		
– cutters	33, 34		
Wire Strippers	42, 43		
Wire Wheel Brushes – steel	55-57		
Wiring Accessories	13, 14		
Wiring Pliers	41, 42		
Work Lights	4, 125		
		Wrecking Bars	
		– goose neck	82
		– tove, Svedbro Smide	81
		Wrenches	
		– adjustable	43
		– chain and strap	36
		– combination	44, 45
		– oil filter	42
		– pipe	35, 36
		– strap	36
		– tongue chain	37
		– 4 way wheel	16
		Y Yarding Blocks	109

NEW PRODUCTS



6V/12V 4A SMART BATTERY CHARGER

- For use with 12V lithium and 6V or 12V lead-acid (including GEL & AGM) batteries
- Includes ring terminals and removable terminal clamps.
- Fully protected against short-circuit, reverse polarity, overcharging & overheating.
- Fully automatic-shuts off when battery is full.
- Input: 105-125V 60Hz AC, output: 6V or 12V DC (4A Max).

ITEM NO.	DESCRIPTION
TE4-0249	Battery Charger 4A Smart



AUTO LAMPS

For Automobiles, Snowmobiles And Motorcycles



ITEM NO.	VOLTAGE	RATING	BASE TYPE
53	12V	1CP	BA9S
57	12V	2CP	BA9S
67	12V	4CP	BA15S
90	12V	6CP	BA15D
93	12V	15CP	BA15S
623	24V	6CP	BA15S
624	24V	6CP	BA15D
906	12V	6CP	Wedge
1141	12V	21CP	BA15S
1142	12V	21CP	BA15D
1156	12V	32CP	BA15S
1156NA	12V	32CP(Amber)	BA15S
1157	12V	32W/4CP	BAY15D
1157A	12V	32W/4CP(Amber)	BAY15D
1251	24V	3CP	BA15S
1252	24V	3CP	BA15D
1683	24V	32CP	BA15S
1816	13V	33A	BA9S
1891	12V	2CP	BA9S
1895	12V	2CP	BA9S
2741	24V	1.2W	T5 Wedge
3057	12V	32/2CP	Plastic W
3157NA	12V	32/3CP(Amber)	Plastic W
3357	12V	40/3CP	S25 Wedge
4057	12V	32/2CP	S25 Wedge
4114	12V	32/3CP	
4157	12V	32/3CP	
**A5225	12V	25/25W	P15D
7440	12V	21W	T20 Wedge
7443	12V	21/5W	T20 Wedge
**A7028	12V	45/40W	P15D-3

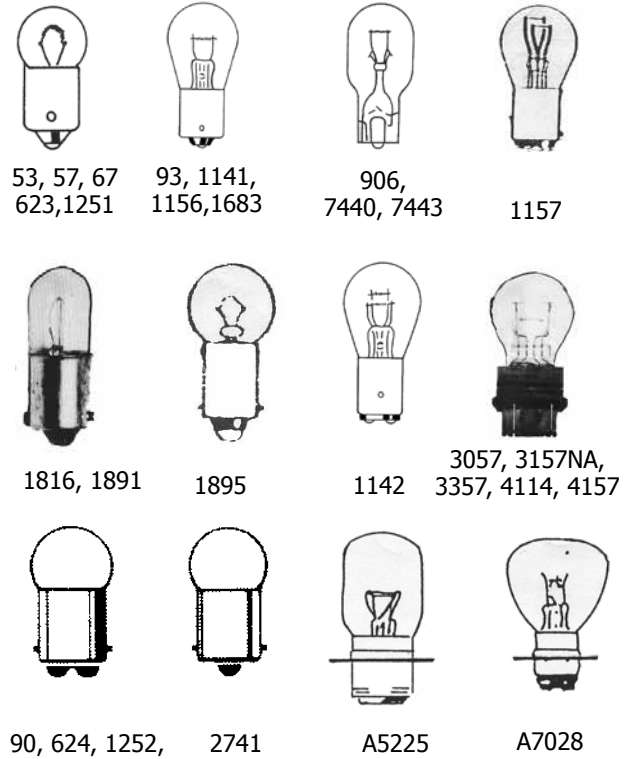

**A5225 - Suitable for Yamaha and Honda ATV's.

**A7028 - Suitable for most ATC's and ATV's.

**Available at Surrey, BC Warehouse Only
Limited Supply, No Back Orders**



HALOGEN LAMPS

For Automobiles, Snowmobiles, Motorcycles And Tractors



- High efficiency.
- Stable colour temperature.
- Longer life.
- Heat impact resistance.
- Resistance to vibration and shock.
- Meets the conditions according to internationally agreed standards (I.E.C.).

TEM NO.	VOLTAGE	WATTAGE	BASE TYPE
H-1-100	12V	100W	PK22S
H-3-100	12V	100W	P43T
H-4-06055	12V	60/55W	P43T
H-4-10055	12V	100/55W	
H-4-10080	12V	100/80W	
H-3-100-24	24V	100W	
H-11-055	12V	55 W	PGJ 19-2
9004	12V	65/45W	
*9004-2	12V	100/80W (High Wattage)	
9005	12V	65W	
*9005-2	12V	100W (High Wattage)	
9005XS	12V	65W	P20D Straight
*9006-2	12V	80W (High Wattage)	
9006XS	12V	55W	P20D Straight
*9007-2	12V	100/80W (High Wattage)	
9008	12V	60/55W	P26.4T
H-7-100	12V	100W	PX260



H-1

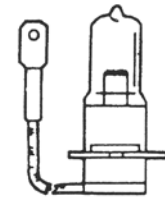

H-3

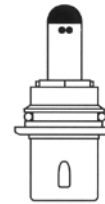

9004



H-4

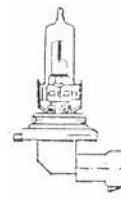

9005, 9005-2



9006-2,
H-11-055



9005XS, 9006XS,

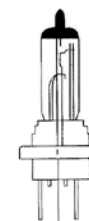

H-7-100

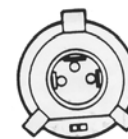

P43T

*Available at Surrey, BC Warehouse Only
Limited Supply, No Back Orders*

FLASHLIGHT - LED Aluminum Body

- Made from aircraft grade aluminum.
- CREE LED used as light source.
- Push on/off switch.
- Has flasher mode when switch pushed halfway.
- Bright 190 lumens output.
- Highly efficient, 3 C cells will provide light for up to 10 hours
- Clamshell carded.



ITEM NO.	DESCRIPTION
LF1174	3 X C Cell Aluminum LED Flashlight

TRACTOR (IMPLEMENT) LIGHT Halogen - Round

- Rubber body.
- Replaceable 12V-H3-55W bulb.
- Universal adjustable plated mounting bracket.
- Beam spread: horizontal 75°, vertical 70°



ITEM NO.	DESCRIPTION
NEO-990	5" Rubber Tractor Light

FLASHLIGHT - LED Head Mounted

- 4 Position switch-3 white LED's on, 6 white LED's on, 4 red LED's on, 4 red LED's flashing.
- 3 strap adjustable elasticized nylon head band.
- ABS Body with plastic lens.
- Adjustable beam angle.



ITEM NO.	DESCRIPTION
TL-9580C	4 Function LED Head Light

TRACTOR (IMPLEMENT) LIGHT LED PAR 36 Round Rubber Work Light

- Flood beam pattern and rubber body.
- 6 High output LED's.
- Suitable for 10-30V applications.
- LED light has aluminum heat diffused body.
- Polycarbonate lens.
- 720 Lumen 8 watt power.
- Suitable for 126mm replacement.
- Stainless bracket and fittings.



ITEM NO.	DESCRIPTION
NEO-1271A	PAR 36 Rubber Work Light
NEO-1271A-04	LED Replacement Assembly

FLASHLIGHT - LED Head Mounted

- Expandable head strap
- 3 position switch allows a total of 230 lumens brightness
- requires 3 AAA batteries (not included)
- 5 tilt positions
- Clamshell packed



ITEM NO.	DESCRIPTION
XG-2209	LED Head Lamp

TRACTOR LIGHT - Halogen

- Size 7 1/4" x 4".
- Black ABS case with handle.
- Swivel rubber mount for flexible installation.
- Suitable for marine, off-road and machinery use.
- Supplied with 12V-H3-55W bulb.
- Individually boxed.
- New flood and spot combination light pattern.



ITEM NO.	DESCRIPTION
8724	Halogen Tractor Light
LENS-8724	Replacement Lens For Above

LANTERN - Camping

- 3 Long LED's which light at 50% or 100% also (total 300 lumens),
- Has 6 flashing red emergency LED's when required
- Requires 3 AA batteries (not included)
- Stainless steel hanger hook
- 6 1/2" overall height
- Boxed



ITEM NO.	DESCRIPTION
XG-8002	Camping Lantern

UTILITY WORK LIGHT - LED

- Water resistant aluminum body powder coat paint
- Recessed lens
- Polarity safe
- Suitable for farm equipment, work trucks, boats and forklifts
- Individually boxed in colourful box
- Supplied with stainless steel fasteners

ITEM NO.	SHAPE	DIMENSIONS W X H X D	VOLTAGE RANGE	BODY COLOUR	BEAM TYPE	NO. OF LEDS	LUMEN RATING	COLOUR TEMP	WATTS	LENS MATERIAL
1248-WH	Rect	6 x 3.75 x 1.75	12-48VDC	White	Flood	6	600	5000K	18W	Glass
1248-BL-8	Rect	6 x 3.75 x 1.75	12-48VDC	Black	Flood	8	800	5000K	23W	Glass
1348-SQ-BLK	Square	4.5 x 4.5 x 1.5	10-30VDC	Black	Spot	5	650	6000K	15W	PMMA
1348-RD-BLK	Round	4.5 x 1.5	10-30VDC	Black	Spot	6	800	6000K	18W	PMMA
1448-SQ-BLK	Square	4.5 x 4.5 x 1.5	10-30VDC	Black	Flood	5	650	6000K	15W	PMMA
1448-RD-BLK	Round	4.6 x 2.75	10-30VDC	Black	Flood	6	800	6000K	18W	PMMA
*1548-SQ-BLK	Square	4.5 x 4.5 x 2.75	9-48VDC	Black	Spot	7	2800	3500K	35W	PC
*1548-RD-BLK	Round	4.6 x 2.75	9-48VDC	Black	Spot	7	2800	3500K	35W	PC
*1648-SQ-BLK	Square	4.5 x 4.5 x 2.75	9-48VDC	Black	Flood	7	2800	3500K	35W	PC
*1648-RD-BLK	Round	4.6 x 2.75	9-48VDC	Black	Flood	7	2800	3500K	35W	PC
*1748-SQ-BLK	Square	4.5 x 4.5 x 2.75	9-48VDC	Black	Spot	7	2800	6000K	35W	PC
*1748-RD-BLK	Round	4.6 x 2.75	9-48VDC	Black	Spot	7	2800	6000K	35W	PC
*1848-SQ-BLK	Square	4.5 x 4.5 x 2.75	9-48VDC	Black	Flood	7	2800	6000K	35W	PC
*1848-RD-BLK	Round	4.6 x 2.75	9-48VDC	Black	Flood	7	2800	6000K	35W	PC
*1948-O-BLK	Oval	4.75 x 3 x 3	9-48VDC	Black	Flood	2	800	5000K	20W	PC
*2048-O-BLK	Oval	4.75 x 3 x 3	9-48VDC	Black	Spot	2	800	Blue	6W	PC

Note: 3500K colour temp - warm white, 6000K colour temp - daylight white. To calculate amp draw, divide wattage by voltage used (35W/12V = 2.91 amps)

***FOB SURREY, BC ONLY**



1248-BL-8



1248-WH



1948-O-BLK
2048-O-BLK



1548-SQ-BLK
1648-SQ-BLK
1748-SQ-BLK
1848-SQ-BLK



1548-RD-BLK
1648-RD-BLK
1748-RD-BLK
1848-RD-BLK



1348-RD-BLK



1448-RD-BLK



1348-SQ-BLK



1448-SQ-BLK

CLEARANCE AND MARKER LIGHTS

ITEM NO.	SIZE L X W X D	LENS COLOUR	BULB SIZE AND QTY.	LENS MATERIAL
MH-1258A	2 1/2" X 1 1/4" x 3/4"	Amber	1 x 194	Poly Carbonate Sealed
MH-1258R	2 1/2" x 1 1/4" x 3/4"	Red	1 x 194	Poly Carbonate Sealed
MH-1260A	3 3/4" x 1 3/16" x 3/4"	Amber	2 x 194	Poly Carbonate Sealed
MH-1260R	3 3/4" x 1 3/16" x 3/4"	Red	2 x 194	Poly Carbonate Sealed
MH-1270A	4" x 2" x 1"	Amber	2 x 194	High Impact Plastic
MH-1270R	4" x 2" x 1"	Red	2 x 194	High Impact Plastic
MH-1275A	4" x 2" x 1 1/8"	Amber	2 x 194	High Impact Plastic
MH-1275R	4" x 2" x 1 1/8"	Red	2 x 194	High Impact Plastic
MH-1288A	2 1/2" Dia. Reflective	Amber	1 x 194	Poly Carbonate Sealed
MH-1288R	2 1/2" Dia. Reflective	Red	1 x 194	Poly Carbonate Sealed



CLEARANCE AND MARKER LIGHTS - LED

ITEM NO.	SIZE L X W X D	LENS COLOUR	NO. OF LEDES	LENS MATERIAL
MH-1277A	2" dia.	Amber	9	Poly Carbonate Sealed
MH-1277R	2" dia.	Red	9	Poly Carbonate Sealed
MH-1279A	2 1/2" dia.	Amber	13	Poly Carbonate Sealed



LIMITED QUANTITIES - NO BACK ORDERS

MARKER LIGHT - LED Bar Light 12V DC

- Stainless steel bar with 3 LED Lights- (each light contains 6 LED's)
- Sealed lens, water resistant.
- Screw mounted.
- Wires, screws and nuts supplied.
- Supplied on a card and UPC coded.



ITEM NO.	SIZE L X W X D	LENS COLOUR	NO. OF LEDES	LENS MATERIAL
TE2-0536R	16 3/4" x 1 3/16" x 1 1/4"	Red	6 per Light	Poly Carbonate
TE2-0536A	16 3/4" x 1 3/16" x 1 1/4"	Amber	6 per Light	Poly Carbonate

CLEARANCE AND MARKER LIGHT - LED

- Sealed lens.
- Waterproof.
- Screw mounted (screws & nuts supplied).
- Carded.

ITEM NO.	SIZE L X W X D	LENS COLOUR	NO. OF LEDES	LENS MATERIAL
TE2-0534A	3 1/4" X 1 1/4" X 7/8"	Amber	6	Poly Carbonate Sealed
TE2-0534R	3 1/4" x 1 1/4" x 7/8"	Red	6	Poly Carbonate Sealed





TURN, STOP, TAIL LIGHTS

ITEM NO.	SIZE L x W x D	LENS COLOUR	BULB SIZE AND QTY.	BODY MATERIAL
MH-23102	4 1/2" x 2 3/8" 2" wire double face	Amber /Red	1 x 1157	Body zinc diecast black 1/2" stud mount
MH-52002R	4 1/2" x 2 3/8" 2" wire single face	Red	1 x 1157	Body zinc diecast black 1/2" stud mount
MH-52002C	4 1/2" x 2 3/8" 2" wire single face	Clear	1 x 1157	Body zinc diecast black 1/2" stud mount
MH-5400R	6 1/2" x 2 1/4" x 2 3/8"	Red	12V 32/3cp	Polycarbonate Sealed
MH-5400C	6 1/2" x 2 1/4" x 2 3/8" back-up light	Clear	12V 32/3cp	Polycarbonate Sealed



MH-23102
MH-52002R
MH-52002C



MH-5400R
MH-5400C

**TURN, STOP, TAIL LIGHTS
With Reflective Outer Ring**

ITEM NO.	SIZE	LENS COLOUR	BULB SIZE AND QTY.	LENS MATERIAL
MH-5800A (2" wire)	4" dia. x 2 1/16"	Amber	12.8V 32/3 cp	Poly Carbonate Sealed
MH-5800R	4" dia. x 2 1/16"	Red	12.8V 32/3 cp	Poly Carbonate Sealed



MH-5800R

STOP, TURN SIGNAL LIGHTS - LED

- Sealed lens, polycarbonate body.
- 3 Wire plug-in.

ITEM NO.	SIZE	COLOUR	NO. OF LED's
MH-5553A	4" Round	Amber	10
MH-5573A	6" Oval	Amber	10



ACCESSORIES FOR MARKER, TURN, STOP, & TAIL LIGHTS

ACCESSORIES FOR MARKER TURN, STOP, TAIL LIGHTS

ITEM NO.	DESCRIPTION
MH-53102	3 Pin Pigtail For MH-5400 and MH-5500.
MH-53103	2 Pin Pigtail For MH-5400.



MH-53102



MH-53103

ITEM NO.	DESCRIPTION
MH-12761	2" Dia. Rubber Grommet
MH-12981	2 1/2" Dia. Rubber Grommet
MH-53101	4" Dia. Rubber Grommet



MH-12761, MH-12781



MH-53101

GROMMET - Rubber

- Suitable for 2 1/2" lights.

ITEM NO.	DESCRIPTION
MH-12981	2 1/2" Diameter Rubber Grommet



LIMITED QUANTITIES - NO BACK ORDERS

LICENSE PLATE LIGHT ASSEMBLY

- Chrome plated to resist corrosion.
- Uses standard #67 bulb.
- 10" lead with connector cover.



ITEM NO.	DESCRIPTION
MH-214014	Chrome Plated License Plate Light Assembly

LIMITED QUANTITIES - NO BACK ORDERS

**TOWING LIGHTS
LED Magnetic Base**



- 15 Bright LED's per light
- Ideal to provide tail, brake and signal lights on vehicles in tow
- Strong magnetic base holds lights in place
- Black painted metal housing ensures long life
- 68" wire between lights
- 29 1/2' long power supply wire
- 4 1/2 light diameter



ITEM NO.	DESCRIPTION
TE2-518D	LED Magnetic Tow Lights

TRAILER LIGHTING KIT



- Suitable for all types of trailers.
- O E M replacement style.
- Kit includes 2 combination Class A stop, tail, turn signal and rectangular marker lights with license plate bracket and license plate light, 2 side marker rectangular amber lights, 20' split Y harness with 4 colour coded wires.
- All lights are also reflective.
- Uses standard #1157 bulb.
- Clamshell packaged
- Spare bulbs available.



ITEM NO.	DESCRIPTION
MH-5750	Trailer Light Kit

EMERGENCY LIGHT - Round Strobe (Large)

- Amber lens, 100,000 candle power
- Strong magnetic base
- Coiled lighter plug cord, expandable to 10', 12V DC
- Impact resistant ABS base
- Suitable for temperatures -30°C to 60°C (-22°F to 140°F)
- Flash rate 70-110/min., operating life 300 hours
- Solid-state circuitry
- Dimensions: 4 3/4" diameter x 4" H.



ITEM NO.	DESCRIPTION
TE2-514	Amber Strobe Light - Boxed
LENS-514R	Red Replacement Lens
LENS-514B	Blue Replacement Lens
LENS-514A	Amber Replacement Lens

**TOWING LIGHTS
Magnetic Base**



- Ideal to provide tail, brake and signal lights on vehicles in tow
- Strong magnetic base holds lights in place
- Black painted metal housing ensures long life
- Replaceable #1157 bulb
- 66" between lights
- Supplied with 19' of encased 4 colour coded wires with an additional 3' uncoated
- 4 5/8" overall diameter housing
- Display boxed



ITEM NO.	DESCRIPTION
TE2-518	Magnetic Tow Lights

EMERGENCY LIGHT - Revolving, Teardrop (Large)

- 12V DC 20W bulb
- Amber lens
- Strong magnet holds unit firmly in place
- Coiled lighter plug cord extends to 90"
- Chrome plated plastic revolving reflector
- Dimensions: 7" L x 4 3/4" W x 5 1/2" H



ITEM NO.	DESCRIPTION
TE2-506	Amber Emergency Light - Boxed
LENS-506R	Red Replacement Lens For TE2-506
LENS-506B	Blue Replacement Lens For TE2-506
LENS-506A	Amber Replacement Lens For TE2-506
BULB-506	Replacement Bulb For Above



STROBE LIGHT - XENON Forklift Type

- Suitable for 12V-80V DC
- 5 1/4" High with screw down fixing
- Flash rate 60-80/minute
- Replaceable strobe
- Conforms to CSA C22.2 and ANSI/UL requirements
- Extra bulb included in attachment pack
- Lens and replacement bulbs available



ITEM NO.	DESCRIPTION
TE2-0527A	Strobe Light
BULB-0527A	Replacement Bulb for TE2-0527A
LENS-0527A	Amber Replacement Lens

FLASHING SAFETY LIGHTS - LED Display

- Long lasting battery life.
- Brighter than standard bulbs.
- Clamshell packed.
- Requires 4 AA batteries.



ITEM NO.	DESCRIPTION	DIMENSIONS	LENS COLOUR	NO. OF LEDS	BATTERY TYPE	NO. OF FUNCTIONS
SH105	Rectangular with Clip & HD Magnet	2 x 2 3/4"	Red	5	2 x AA	6
SH501	Rectangular with Stand & HD Magnet	3 3/4" x 6 1/2"	Red	18	4 x AA	2
SH501A	Rectangular with Stand & HD Magnet	3 3/4" x 6 1/2"	Amber	18	4 x AA	2



SH501
SH501A

SH105

GAUGES - 52mm (2")

- Mechanical bourdon tube meter movements, 90° scale.
- Supplied with individual metal mounting bracket.
- All gauges are made with metal cases.
- All hardware and mounting instructions included.
- Includes 12V lighting assembly in each pack.
- Clamshell packed.

ITEM NO.	DESCRIPTION
GV-520	Volt Meter (8-16 Volts)
G-2101	Ammeter Gauge, -60 - 0 +60 Readings
G-2102	Water Temperature Gauge- Dual Scale: 54°C To 138°C and 130°F To 280°F
G-2103	Oil Pressure Gauge- Dual Scale: 5.6kg/cm ² and 0-80 PSI
G-2301	Triple Gauge Set 1 Ammeter, 1 Water, 1 Oil



GV-520



G-2101, G-2102, G-2103

TIMING LIGHT

- Works on all 12V systems
- Impact resistant ABS housing.
- Neon double check indicator insures proper hookup.
- Detachable H.D. Inductive pick-up clamps and leads.
- Bright Xenon flash.
- Replaceable Xenon bulb.

ITEM NO.	DESCRIPTION
TA-2200	Adjustable Advance, Heavy Duty Timing Light, Advance 0-60 Degrees TDC
TL-2200	Heavy Duty Timing Light
TL-020	Carded Replacement Bulb For TL-2200 & TA-2200



DIGITAL MULTITESTER



- Dimensions 3 1/8" x 4 3/4" x 3/4".
- cETL certified.
- Low battery indicator.
- Automatic negative polarity indicator.
- Auto power-off.
- Auto ranging and data-hold functions.
- Audible continuity check.
- Attractively boxed.



ITEM NO.	DESCRIPTION
M320	Digital Multi-Tester

FUNCTION/FONCTION	Range/Gamme	Accuracy/Precision
DC Voltage/Voltage CC	400mV/4V/40V/400V	±(0.5%+3)
	600V	±(0.8%+3)
AC Voltage/Voltage AC	4V/40V/400V	±(0.8%+4)
	600V	±(1.0%+4)
DC Current/Courant CC	40mA/400mA	±(2.0%+3)
AC Current/Courant AC	40mA/400mA	±(3.0%+4)
Resistance/Résistance	400Ω/4kΩ/40kΩ/400kΩ/4MΩ	± (1.0%+3)
	40MΩ	± (2.0%+4)
	4nF	± (5.0%+10)
Capacitance	40nF	± (4.0%+5)
	400nF/4μF/40μF/100μF	± (3.0%+3)
	0-100kHz	± (0.5%+3)

FEATURES/CARACTÉRISTIQUES

Display/Affichage	Counts/Comptes	4000
Auto Ranging/Auto-Gamme	Auto	•
Auto Power Off/Hors-Courant Automatique		•
Diode		1.5V
Continuity Buzzer/Sonnette de Continuite		<50±20Ω
Data Hold/Maintien de Données		•

GENERAL/GÉNÉRAL

Power Supply/Alimentation		357A(L-R44)/1.5Vx2
Size/Taille	120x7018mm/4.7"x 2.75"x 0.7"	
Weight/Poids	110g/0.23lbs	
Safety Rating/Cote de Sécurité	CAT II 600V CAT III 300V RoHS	

COMPRESSION TESTERS



- 2 1/2" dial with metal case.
- Colour coded quadruple calibrations with 0-300 psi, 21 kg/cm², 21 bar and 2100 kpa.

ITEM NO.	DESCRIPTION
----------	-------------

- G-324 4 Pc. Kit In Molded Abs Case: Chrome Plated Gauge With Quick Release Coupler, 6" Rigid Extension W/Rubber Cone, 12" Flex Hose With 14/18mm Adapter, Uses Side Release Valve
- G-320HD Gauge Supplied With 12" Heavy Duty Flex Hose & 14/18mm Adapter, Uses Side Release Valve
- G-310 Vacuum & Fuel Pump Tester



ANTIFREEZE TESTER

- Carded.

ITEM NO.	DESCRIPTION
----------	-------------

- TT1-243A Antifreeze Tester -12°C To -43°C (+10°F To -45°F)



BATTERY TESTER - Load Test

- Used to test batteries (6 or 12 volts), charging systems and starter motors.
- Completely portable.
- Tests completed in 30 seconds.
- Heavy duty colour coded copper plated clamps.
- Ventilated, black painted steel case.
- Suitable for 500-1000 cold cranking amps.
- Individually boxed.



ITEM NO.	DESCRIPTION
----------	-------------

- BT-260 Battery Tester



**BATTERY MAINTAINER
12 VOLT 0.75 AMP**

- Provides 0.75 AMP charging, ideal for seasonal vehicles.
- Auto shut-off.
- Short circuit protected.
- Input 120 VAC, output 0.75 AMP.
- Suitable for lead acid, wet maintenance free and gel batteries.
- Supplied with alligator clips, ring terminal and quick connect fittings.
- cETL listed.



ITEM NO.	DESCRIPTION
TE4-0237	Battery Maintainer

BATTERY CHARGER- 1.5 AMP Output

- Suitable for 12V lead acid batteries.
- Protection against overcharge, short circuit.
- Automatic shut-off.
- LED indicators.
- Water and shock resistant case.
- Attractively clamshell packaged.



ITEM NO.	DESCRIPTION
TE4-0218A	1.5 Amp Charger (Maintainer)

**BATTERY CHARGER
Automatic Shut Off**

- Suitable for 6V and 12V systems.
- Automatic shut-off on 12V only.
- Polarity check light.
- Green indicator light to indicate complete charge
- 6 1/2' power cord and 6 1/2' battery leads.
- 2 amp rating for smaller batteries - (motorcycles, ATV's & lawn mowers) and trickle charge.
- 10 amp rating for normal charging.
- 55 amp rating for starting power (after several minutes of charging).
- cUL approved.



ITEM NO.	DESCRIPTION
JC-S106	Battery Charger Auto-Shut Off

TRAILER LIGHT ADAPTERS



- Used to connect trailer lights to vehicles with separate turn signals that are independent from stoplights.
- Supplied with colour-coded wires for easy installation.
- 20" brown, yellow, white, red, 72" green leads car side, 72" leads trailer side.
- Supplied with pressure sensitive backing to allow fastening to inner trunk.
- Supplied with 4-way flat trailer end.
- Blister carded.



ITEM NO.	DESCRIPTION
SH-48925	Converts 5 wire car side to 4 wire trailer side.

**CIRCUIT CONDUCTIVITY
TESTER**



- Used to check circuitry at female end of trailer electrical connectors.
- Checks L-Turn, R-Turn, brake and tail light wire positions.
- Positions may vary dependant on vehicle.
- LED indicators show connectivity.
- Packaged in poly bag with hanger card.



ITEM NO.	DESCRIPTION
SH-A7088	Circuit Conductivity Tester

L SHAPED MOUNTING BRACKET

- Used for mounting car side female 7-Way connectors under bumpers or frame.
- Black powder coat finish.
- Packaged in poly bag with hanger card.



ITEM NO.	DESCRIPTION
SH-W9394	Mounting Bracket For 7-Way Connector

TRAILER ELECTRICAL CONNECTORS



- Packaged in poly bag with hanger card.

ITEM NO.

DESCRIPTION

SH-A7274-CBQ

Coiled 7-way round to 4-way flat with coiled 48" x 16 gauge adaptor



SH-D5103

5-Way Flat To 5-Way Flat Trailer Connector
18 Gauge Wire
12" Long



SH-C7092

7-Way Connector, Impact Resistant, Plastic Housing. "Rubber Seal" on Door (Car End)



SH-C7094

7-Way Connector With Seal, Impact Resistant Plastic Female End (car end), Spring Loaded Cover Plate, Complete With 4-Way Flat Connector With 12" 18 Gauge Wires And 4 Each 12" 12 Gauge Butt And Ring Connectors



SH-7081

7-way connector, impact resistant plastic housing, male end (car end)



SH-A7274

7 Wire round plastic male trailer end converts 7 wire to 4 wire flat.



SH-C4013

4-Way Connector Set (Male/Female) Secure Locking Spring-Loaded Cover Which Locks In Male Plug. 1-3/8" OD Female Barrel 1-1/8" OD Male Barrel Chrome Plated



SH-A7275

7 Wire round centre pole trailer end converts to 5 wire flat end.



SH-A7264

6-Way Round To 4 Way Flat Adaptor ABS Construction



SH-S2102-10G

2-Way Flat Connector Loop With 12" 10 Gauge Wires



SH-S2102-10G
SH-S2102-14G

SH-S2102-14G

2-Way flat connector loop 12", 14 gauge wire

SH-C7039

7-Way Round Pin Type, Die Cast Zinc Body, Trailer End Receiver With Spring Cable Guard 1-1/2" Male Barrel Coated To Resist Corrosion



SH-44140

4-Way rubber coated flat type connector with 12" leads, 18 gauge wire.

SH-44141

4-Way rubber coated flat type connector with 48" leads, 18 gauge wire.



SH-44140
SH-44141



BATTERY TERMINAL/PIPE BRUSH

- 1 piece with 4 functions, large and small internal and external capabilities.
- Large easy grip plastic handle.
- Suitable for cleaning tubing 1/2" - 3/4" ID and 1/2" - 3/4" OD.
- Carded.



ITEM NO.	DESCRIPTION
MTB-41	4 Way Battery Terminal/Pipe Brush Plastic Handle

BATTERY TERMINALS AND ADAPTERS

- Heavy duty lead bodies.

AUTOMOTIVE

ITEM NO.	DESCRIPTION
BT5A-1	Standard
BT5A-2	Standard
BT5A-10	Standard
BT19B-1	Side Mount



BT5A

BT19B

MARINE

BT28-1	Marine Disconnect & 3/8" Stud Conversion - Bulk
BT28-10	Marine Disconnect & 3/8" Stud Conversion - 10/Card



BT28

BATTERY TERMINAL BRUSH

- Sturdy nickel-plated metal body.
- Includes brush for post and tapered brush for clamp cleaning.



ITEM NO.	DESCRIPTION
BTB-1	Battery Terminal Brush

BOOSTER CABLE

- Thermoplastic rubber.
- At -45°C remains tangle-free.
- Cable coatings are highly resistant to oils and chemicals.
- 100% copper strands.

ITEM NO.	DESCRIPTION	AMP RATING	WIRE SIZE	NO. OF WIRES	CABLE LENGTH
32-065A-3	Battery Booster Cable, Sleeve Packed	150	10	65	10'
32-172D	Battery Booster Cable, Boxed Parrot-Jaw	800	6	172	12'
32-259D	Battery Booster Cable, Boxed Parrot-Jaw	800	4	259	16'
32-545D	Battery Booster Cable, Boxed Parrot-Jaw	800	2	413	25'



CLAMPS FOR BATTERY BOOSTER CABLES

- Chrome plated.
- Vinyl coated handles.
- Available in red and black colours.
- Parrot jaw type.

ITEM NO.	DESCRIPTION
32-D2BL	Black Booster Cable Clamp
32-D2RD	Red Booster Cable Clamp



FUSES - Plug-In Type

- Supplied in multiple compartment plastic box.
- Standard size and mini.
- Suitable for up to 32V.

ITEM NO.	DESCRIPTION
TE5-0442	120 Piece Standard Size Plug-In Fuses, 20 Each-5A, 10A, 15A, 20A, 25A, 30A
TE5-0454	100 Piece Mini Size Plug-In Fuses, 20 Each-5A, 10A, 15 each-15A, 20A, 25A, 30A



BUTT CONNECTOR KIT

- Includes both PVC and heat shrink types.
- Supplied in handy 3 1/2" x 8 1/2" plastic partitioned see-thru box with hang-up hook.

ITEM NO.	DESCRIPTION
TE5-0503	76 Piece Connector Kit Kit Consists Of: 26 - 22/18 Gauge - Red PVC Butt Connector 26 - 16/14 Gauge - Blue PVC Butt Connector 18 - 12/10 Gauge - Yellow PVC Butt Connector 2 - 22/18 Gauge - Red PVC Heat-Shrink Butt Connector 2 - 16/14 Gauge - Blue PVC Heat-Shrink Butt Connector 2 - 12/10 Gauge - Yellow PVC Heat-Shrink Butt Connector



HEAT-SHRINK TUBING KIT

- Operating temperature -55°C to 125°C.
- Supplied in handy 3 1/2" x 8 1/2" plastic partitioned see thru box with hang-up hook.

ITEM NO.	DESCRIPTION
TE5-0500	185 Piece x 2 1/2" Heat Shrink Tubing Kit - Black Kit Consists Of: 65 - 1/16" (2mm) - 2 1/2" 45 - 1/8" (3mm) - 2 1/2" 25 - 3/16" (5mm) - 2 1/2" 20 - 1/4" (6mm) - 2 1/2" 15 - 3/8" (9mm) - 2 1/2" 15 - 1/2" (13mm) - 2 1/2"
TE5-0501	120 Piece x 2 1/2" Heat-Shrink Tubing Kit - Colour Coded Kit Consists Of: 40 - 22/18 Gauge 2 1/2" - Red 40 - 16/14 Gauge 2 1/2" - Blue 40 - 12/10 Gauge 2 1/2" - Yellow



INSULATED RING CONNECTOR KIT

- Supplied in handy 3 1/2" x 8 1/2" plastic partitioned see-thru box with hang-up hook.

ITEM NO.	DESCRIPTION
TE5-0504	80 Piece Ring Connector Kit Kit Consists Of: 35 - 5mm PVC #10 Ring Connectors - 15 - 22/18 Gauge - Red - 15 - 16/14 Gauge - Blue - 5 - 12/10 Gauge - Yellow 35 - 8mm PVC 5/16" Ring Connectors - 15 - 22/18 Gauge - Red - 15 - 16/14 Gauge - Blue - 5 - 12/10 Gauge - Yellow 6 - 5mm Nylon #10 Ring Connectors - 2 - 22/18 Gauge - Red - 2 - 16/14 Gauge - Blue - 2 - 12/10 Gauge - Yellow 2 - 6mm Nylon 1/4" Ring Connectors - 2 - 16/14 Gauge - Blue 2 - 8mm Nylon 5/16" Ring Connectors - 2 - 12/10 Gauge - Yellow



CABLE TIE ASSORTMENT KIT

- Supplied in handy 3 1/2" x 8 1/2" plastic partitioned see thru box with hang-up hook.

ITEM NO.	DESCRIPTION
TE5-0502	270 Piece Self-Locking Cable Ties And Adhesive Back Mounting Pads Kit Consists Of: 160 - 4" Ties (80 White, 80 Black) 100 - 8" Ties (50 White, 50 Black) 10 Adhesive Back Mounting Pads





QUICK-DISCONNECT CONNECTOR KIT

- Combination PVC & nylon ends.
- Supplied in handy 3 1/2" x 8 1/2" plastic partitioned see thru box with hang up hook.

ITEM NO.	DESCRIPTION
TE5-0505	80 Piece Quick-Disconnect Connector Kit Consists Of: 12 - 22/18 Gauge - Red Female PVC 12 - 16/14 Gauge - Blue Female PVC 10 - 12/10 Gauge - Yellow Female PVC 12 - 22/18 Gauge - Red Male PVC 12 - 16/14 Gauge - Blue Male PVC 10 - 12/10 Gauge - Yellow Male PVC 2 - 22/18 Gauge - Red Female Nylon 2 - 16/14 Gauge - Blue Female Nylon 2 - 12/10 Gauge - Yellow Female Nylo 2 - 22/18 Gauge - Red Male Nylon 2 - 16/14 Gauge - Blue Male Nylon 2 - 12/10 Gauge - Yellow Male Nylon



CABLE CLAMP KIT

- Ideal for mounting wires, cables and hoses.
- Supplied in handy 3 1/2" x 8 1/2" plastic partitioned see thru box with hang up hook.

ITEM NO.	DESCRIPTION
TE5-0507	90 Piece Cable Clamp Kit Consists Of: 2 - 1/4" Dia. Rubber Coated SS Cable Clamps 2 - 5/16" Dia. Rubber Coated SS Cable Clamps 2 - 3/8" Dia. Rubber Coated SS Cable Clamps 2 - 7/16" Dia. Rubber Coated SS Cable Clamps 22 - 1/8" Dia. Nylon Clamps - (12 Black, 10 White) 30 - 3/16" Dia. Nylon Clamps - (15 Black, 15 White) 30 - 1/4" Dia. Nylon Clamps - (15 Black, 15 White)



QUICK-SPLICE KIT

- Supplied in handy 3 1/2" x 8 1/2" plastic partitioned see thru box with hang-up hook.

ITEM NO.	DESCRIPTION
TE5-0506	70 Piece Quick-Splice Kit Consists Of: 15 - 22/18 Gauge - Red Connector 20 - 16/14 Gauge - Blue Connector 5 - 12/10 Gauge - Yellow Connector 15 - 16/14 Gauge - Quick Disconnects 15 - 16/14 Gauge - T-Taps



WIRE CONNECTOR AND WIRE NUT KIT

- Supplied in handy 3 1/2" x 8 1/2" plastic partitioned see-thru box with hang-up hook.

ITEM NO.	DESCRIPTION
TE5-0508	120 Piece Closed End Connector/ Wire Nut Assortment Kit Consists Of: 25 -16/14 Gauge Nylon Closed End Connectors 20 -12/10 Gauge Nylon Closed End Connectors 25 - Red Twist-On Wire Connectors 25 - Grey Twist-On Wire Connectors 25 - Yellow Twist-On Wire Connectors



BACK-UP ALARM

- Suitable for 12 - 24 V DC systems.
- Sealed solid-state circuitry, water and dust resistant.
- Made with strong ABS housing.
- 100 DB + or - 2 DB.
- Measures 4" W x 3" H x 1 3/4" D.

ITEM NO.	DESCRIPTION
CM-668	Back-up Alarm



WINDSHIELD WIPER BLADES – ISO-9001

- 100% rubber blade.
- Stainless steel blade flex strip.
- Strong metal frame.
- All supplied with suitable adapter for 6/8mm hook, 7/9mm hook, side pin and 7mm bayonet fitting except WB-1028S which is supplied with hook fittings only.
- Card back has convenient metric/inch scale.
- Blades are packed 1 per blister card.

ITEM NO.	BLADE LENGTH	DESCRIPTION
WB-1016S	16"	Rubber Blade Assembly
WB-1017S	17"	Rubber Blade Assembly
WB-1018S	18"	Rubber Blade Assembly
WB-1019S	19"	Rubber Blade Assembly
WB-1020S	20"	Rubber Blade Assembly
*WB-1022S	22"	Rubber Blade Assembly
WB-1024S	24"	Rubber Blade Assembly
WB-1028S	28"	Rubber Blade Assembly

**FOB DARTMOUTH, NS ONLY*



WINDSHIELD WIPER BLADES - TFE Rubber

- No exposed flex strip which gives better coverage and less icing.
- TFE rubber means less noise and chatter.
- New aerodynamic spoiler design gives better vision at high speeds.
- Adapters included.
- Resealable blister carded and UPC coded.

ITEM NO.	BLADE LENGTH
Y007-16	16"
Y007-17	17"
Y007-18	18"
Y007-19	19"
Y007-20	20"



*LIMITED QUANTITIES
NO BACKORDERS ON WIPER BLADES*

ICE SCRAPERS AND SNOW BRUSHES

ITEM NO.	DESCRIPTION
XP-4577	Acrylic 4" Blade Ice Scraper With Hang-Up Hole
XP-4571R	24" Heavy Duty 4" Ice Scraper & Brush
XP-6530	Snow Brush W/Ice Scraper 25" X 5/8" X 7/8" Wood Handle 2 Rows Of PVC Bristle With Ice Scraper On End

XP-4577

XP-4571R

XP-6530

XP-4528R	6" Aluminum Handle, Extendable 30" To 45" Scraper W/ Adjustable Angle Brush And Squeegee
----------	--

XP-4528R

- Designed to remove snow from cars & trucks.
- Large 15" x 5-1/2" foam pad has 3 levels to minimize any scraping.
- Head locks into 7 positions to give required angle.
- Handle locks from 30" to 49" with a total of 8 positions.

ITEM NO.	DESCRIPTION
XP-462002	Snow Brush & Scraper



SQUEEGEES - Automotive

- 10" nylon net-covered foam head.
- Rubber wiping blade on reverse side of head.
- Threaded handles allow for easy storage.

ITEM NO.	DESCRIPTION
3940	10" Metal Squeegee With 20" Wood Handle





SQUEEGEES - Automotive Cont'd

CT-613 10" ABS Squeegee With Telescopic Aluminum Handle
Extends From 27" To 48"
Has Rubber Grip With Hang-Up Hole



TIRE PRESSURE GAUGE

- Chrome plated to resist corrosion.
- For most types of air filled tires.



ITEM NO.	DESCRIPTION
----------	-------------

TE6-014	Regular extension service gauge 10-160 PSI both sides metallic bar. Chromed copper body dual angle head. Handy hang-up ring. 11 1/2" overall length. Boxed.
---------	---

HAND PUMP

- 23" overall length with 17" pressure stroke.
- 22" rubber hose with spring clip.
- Two-piece detachable nozzle.
- Tubular steel handle.



ITEM NO.	DESCRIPTION
----------	-------------

*S-297	23" Hand Pump
--------	---------------

**FOB DARTMOUTH, NS ONLY*

SAND BLASTER KIT

- Used for sand blasting, and liquid and air cleaning of parts and surfaces.
- Kit includes:
Gun with 1/4" nozzle
3 extra 1/4" nozzles
(1) 13/64" air jet
10 ft rubber hose
12" pick-up tube



ITEM NO.	DESCRIPTION
----------	-------------

*ASB-6	Sand Blaster Kit - Blister Packed
--------	-----------------------------------

*ASB-64	Set Of Replacement Nozzles
---------	----------------------------

**FOB DARTMOUTH, NS ONLY*

AIR HAMMER KIT

- Set contains 1 each: Flat, hatched, "V", and pointer chisels.
- Spare spring included.
- Air hose fitting included
- Supplied in molded plastic case.



ITEM NO.	DESCRIPTION	WEIGHT
----------	-------------	--------

*2709-1	Air Hammer 190mm (7-1/2")	5.0 lbs.
	4 Chisels 125mm (5")	

**FOB DARTMOUTH, NS ONLY*

TUBELESS TIRE VALVE STEMS

- Plastic valve cap supplied.
- Sold 100/bag only.



ITEM NO.	OVERALL LENGTH	BASE SIZE
----------	----------------	-----------

TR413	42.5 (1 1/16")	11.5mm
TR415	42.5 (1 1/16")	15.9mm
TR418	61.5 (2 7/16")	12mm x 1.5

WHEEL LUG NUTS

- Chrome plated to resist corrosion.
- Standard hex nut sizes 13/16" or 3/4".
- Tapered edge.
- Each nut clearly identified with size.
- Right hand turning.
- Boxed 50 per box.



ITEM NO.	WRENCH SIZE	WHEEL STUD SIZE
----------	-------------	-----------------

LM001-14150	13/16"	14mm x 1.5
LM023-12125	3/4"	12mm x 1.25
LM023-12150	3/4"	12mm x 1.5
LM023-7-16	3/4"	7/16"
LM023-1-2	3/4"	1/2"

4-WAY WHEEL WRENCH

- 20" overall width.
- 11/16", 3/4", 13/16" and 7/8" wheel nut sizes.
- Sizes embossed on each end.
- Chrome plated to resist rusting.



ITEM NO.	DESCRIPTION
----------	-------------

03-1101	4-Way Wheel Wrench
---------	--------------------

MECHANIC'S CREEPER

- Heavy rectangular tube frame.
- Durable powder-coat paint.
- 6 x 2 1/2" hard plastic wheels with ball bearing swivel base.
- Full 11" x 36" padded body support with built-in pillow.

ITEM NO.	DESCRIPTION
TR6451	6 Wheel Mechanic's Creeper
TR-WHEEL	Replacement Casters



MECHANIC'S STOOL

- 14" x 8 1/2" padded seat.
- All steel construction.
- 15" overall height.
- 4 swivel casters.
- Handy 11 1/2" x 12 1/2" partitioned parts tray under seat.



ITEM NO.	DESCRIPTION
TR6100	Mechanic's Stool
TR6100-01	Swivel Castors for TR6100

HOSE CLAMPS

- Band and housing made of 430 stainless steel. Tightening screw made of zinc plated steel. Packed 10 pieces per box sold in boxes of 10 only.

ITEM NO.	SAE SIZE	BAND WIDTH		DIAMETER RANGE	
		INCH	MM	INCH	MM
HC-002	#2	5/16"	9mm	1/4" - 1/2"	6mm - 12mm
HC-004	#4	5/16"	9mm	5/16" - 5/8"	8mm - 16mm
HC-005	#5	5/16"	9mm	7/16" - 3/4"	11mm - 20mm
HC-006	#6	5/16"	9mm	1/2" - 3/4"	12mm - 23mm
HC-008	#8	5/16"	9mm	1/2" - 1"	13mm - 25mm
HC-010	#10	1/2"	12.7mm	9/16" - 1 1/16"	14mm - 27mm
HC-012	#12	1/2"	12.7mm	11/16" - 1 1/4"	17mm - 32mm
HC-016	#16	1/2"	12.7mm	11/16" - 1 1/2"	17mm - 38mm
HC-020	#20	1/2"	12.7mm	13/16" - 1 3/4"	21mm - 44mm
HC-024	#24	1/2"	12.7mm	1" - 2"	25mm - 51mm
HC-028	#28	1/2"	12.7mm	1 1/4" - 2 1/4"	32mm - 57mm
HC-032	#32	1/2"	12.7mm	1 1/2" - 2 1/2"	38mm - 63mm
HC-036	#36	1/2"	12.7mm	1 3/4" - 2 3/4"	44mm - 70mm
HC-044	#44	1/2"	12.7mm	2 1/4" - 3 1/4"	57mm - 82mm
HC-052	#52	1/2"	12.7mm	2 3/4" - 3 3/4"	70mm - 95mm
HC-064	#64	1/2"	12.7mm	3 1/2" - 4 1/4"	89mm - 114mm
HC-072	#72	1/2"	12.7mm	4" - 5"	102mm - 127mm
HC-088	#88	1/2"	12.7mm	5" - 6"	127mm - 152mm
HC-104	#104	1/2"	12.7mm	6" - 7"	152mm - 178mm





HOSE CLAMPS CONT'D

- Band and housing made of 304 stainless steel. Tightening screw made of 304 stainless steel. Packed 10 pieces per box (sold in boxes of 10 only).

ITEM NO.	SAE SIZE	BAND WIDTH		DIAMETER RANGE	
		INCH	MM	INCH	MM
304-002	#2	5/16"	9mm	1/4" - 1/2"	6mm - 12mm
304-004	#4	5/16"	9mm	5/16" - 5/8"	8mm - 16mm
304-005	#5	5/16"	9mm	7/16" - 3/4"	11mm - 20mm
304-006	#6	5/16"	9mm	1/2" - 3/4"	12mm - 23mm
304-008	#8	5/16"	9mm	1/2" - 1"	13mm - 25mm
304-010	#10	1/2"	12.7mm	9/16" - 1 1/16"	14mm - 27mm
304-012	#12	1/2"	12.7mm	11/16" - 1 1/4"	17mm - 32mm
304-016	#16	1/2"	12.7mm	11/16" - 1 1/2"	17mm - 38mm
304-020	#20	1/2"	12.7mm	13/16" - 1 3/4"	21mm - 44mm
304-024	#24	1/2"	12.7mm	1" - 2"	25mm - 51mm
304-028	#28	1/2"	12.7mm	1 1/4" - 2 1/4"	32mm - 57mm
304-032	#32	1/2"	12.7mm	1 1/2" - 2 1/2"	38mm - 63mm
304-036	#36	1/2"	12.7mm	1 3/4" - 2 3/4"	44mm - 70mm
304-044	#44	1/2"	12.7mm	2 1/4" - 3 1/4"	57mm - 82mm
304-052	#52	1/2"	12.7mm	2 3/4" - 3 3/4"	70mm - 95mm
304-064	#64	1/2"	12.7mm	3 1/2" - 4 1/4"	89mm - 114mm
304-072	#72	1/2"	12.7mm	4" - 5"	102mm - 127mm
304-088	#88	1/2"	12.7mm	5" - 6"	127mm - 152mm
304-104	#104	1/2"	12.7mm	6" - 7"	152mm - 178mm



HI-LIFT JACKS, PREMIUM CAST & STEEL JACK - Made in U.S.A. Meets ANSI Requirements

- Base plate of 28 square inches.
- Low pick-up of 4 1/2".
- Safety shear-pin shears at 7000 lbs.
- Manufactured of high stress steel and Class A Grade 1 castings.



ITEM NO.	DESCRIPTION	LIFT
HL-364	36" Premium Jack	25"
HL-484	48" Premium Jack	37"
HL-604	60" Premium Jack	49"

*PRICE INCLUDES TOP CLAMP CLEVIS

FIX-IT KIT FOR SERVICING HI-LIFT JACKS

- Kit contains:
 - 2 CP-1 climbing pins
 - 2 CP-2 cross pins
 - 2 CP-3 climbing pin springs
 - 1 SP-13 safety shear-pin
 - 1 LT-1 lubrication tube
 - 1 installation instructions



ITEM NO.	DESCRIPTION
HL-484-99-FK2	FIX-IT KIT

* Other parts for HI-LIFT are available on request.

ACCESSORIES FOR HI-LIFT

ITEM NO.	DESCRIPTION
HL-484-99-LOC	"LOC" Rack For Locking Hi-Lift To Vehicle



WINCH - 2,000 lb. Capacity

- 12 Volt DC permanent magnet motor .85 HP.
- 50 feet of 5/32" aircraft cable with safety latch hook.
- 54 inch remote control cable in/out buttons.
- 68 inch power leads.
- Cable tension plate to ensure level winding, free spooling and power in and out.
- Supplied with hand saver bar.
- Bolts and mounting plate included.
- Overall dimensions: L11 1/2" x W 4" x H 4".
- Roller fairlead included.



ITEM NO.	LINE PULL	LINE SPEED	WEIGHT	AMP DRAW
DJS-2000	0-2000 lbs.	10.5-4.2 f/min	11 1/2 lbs.	8-118

WINCH - 3,500 lb. Capacity

- 12 Volt DC permanent magnet motor 1.3 HP.
- 50 feet of 7/32" aircraft cable with safety latch hook included.
- 10' leads on remote rocker switch (in/out).
- Overall dimensions: L 12 1/2" x W 4 3/4" x H 5 1/2".
- Supplied with hand-saver bar.
- Roller fairlead included.



ITEM NO.	LINE PULL	LINE SPEED	WEIGHT	AMP-DRAW
DJW-3500	0-3500 lbs	26-5 f/min	28 lbs.	20-230

BOAT WINCHES - General Purpose

- Rust-resistant zinc finish.
- Internally lubricated drum bushing and pinion gear shaft bearing for long life and ease of operation.
- Reinforced frame gives extra strength.
- Stainless steel ratchet spring.
- Smooth turning roller grip handle.



ITEM NO.	DESCRIPTION
GH-1000	1,000 lb. Capacity
GH-2000	2,000 lb Capacity

BOAT WINCH - Strap Type

- Rust-resistant zinc finish.
- Supplied with 2" strap and hook with safety latch.
- 25' long strap.
- Single speed.



ITEM NO.	DESCRIPTION
T18	Boat Winch with Strap 1800 lbs. Capacity
T18-01	Handle for T18
T18-02	Spring for T18
T18-03	Pawl for T18
T18-04	Strap/Hook Replacement for T18

ROTATING ENGINE STANDS

- 1,000 lbs. capacity.
- Heavy gauge tubular construction.
- 4 wheel construction for stability.
- Adjustable mounting arms.
- Mounting plate rotates 360° with 8 lock positions
- 35" height.
- Rear frame is 31 1/4" wide with 4 steel wheels.
- Front stabilizer frame is 18" wide with 3 1/2" ball bearing swivel steel wheels.



ITEM NO.	DESCRIPTION
ES-1000	1,000 lb. Engine Stand

ROTATING ENGINE STANDS CONT'D

- Heavy gauge tubular construction.
- 4 wheel construction for stability.
- Rear wheels are 3 1/2" fixed cast iron.
- Front wheels are 3 1/2" swivel cast iron w/ball bearing mounting plate.
- 4 adjustable mounting arms accommodate most engines.
- Mounting plate rotates 360° with 8 lock positions
- 34" height.
- Stabilizer arms are 34" long with 34" width.
- Swing-away tool tray.

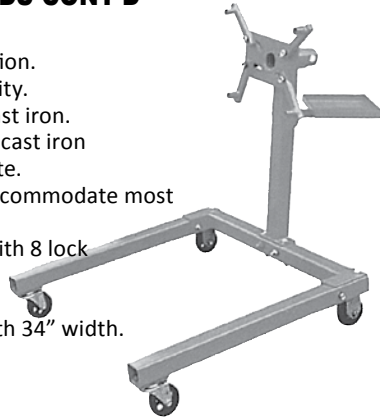
TRAILER HITCH BALLS - Clamshell Packed

- UPC labeled.

ITEM NO.	BALL AND THREAD SIZE	BOLT LENGTH	LOAD RATING
28-1B	1 7/8" X 3/4"	2"	2,000 lbs.
28-2B	1 7/8" x 1"	2"	2,000 lbs.
28-3B	2" x 3/4"	2"	3,500 lbs.
28-4B	2" x 1"	2"	6,000 lbs.
28-5B	2 5/16" x 1"	2"	6,000 lbs.



ITEM NO.	DESCRIPTION
ES-1250	1,250 lb. Engine Stand

JACK STANDS - Ratchet Type

- Sturdy 4 leg welded steel stands.
- Has load-lock handle that prevents stand from being lowered until load is removed from saddle.
- Wide saddle provides maximum stability.
- Sold in pairs.



ITEM NO.	TONS CAPACITY	MIN. HEIGHT	MAX. HEIGHT	MAX. LIFT
ST-3	3	11 3/16"	16 3/4"	5 3/4"
ST-6	6	16"	24"	8"

BALL MOUNT - Triple Ball

- Solid steel 2" bar with 1 7/8", 2", 2 5/16" welded trailer balls.
- Accommodates 1 7/8" (2,000 lbs.), 2" (6,000 lbs.), 2 5/16" (10,000 lbs.) couplers.
- Black painted bar with chrome plated trailer balls.
- Uses 5/8" pin.



ITEM NO.	DESCRIPTION	WEIGHT
28-TRIBALL	Triple Ball Mount w/Chromed Balls	20 lbs.

TRAILER HITCH BALLS

- Solid steel, chrome plated.

ITEM NO.	BALL AND THREAD SIZE	LOAD RATING
<i>External Thread:</i>		
28-1	1 7/8" x 3/4"	2,000 lbs.
28-2	1 7/8" x 1"	2,000 lbs.
28-3	2" x 3/4"	3,500 lbs.
28-4	2" x 1"	6,000 lbs.
28-4A	2 x 1 1/4"	8,000 lbs.
28-5	2 5/16" x 1"	6,000 lbs.
28-6	2 5/16" x 1 1/4"	12,000 lbs.

External Thread with 2 1/2" Long Bolt:

28-1L	1 7/8" x 3/4"	2,000 lbs.
28-3L	2" x 3/4"	3,500 lbs.
28-4L	2" x 1" 3" Long Bolt	5,000 lbs.

Internal Thread:

28-7	1 7/8" x 3/4"	2,000 lbs.
28-8	2" x 3/4"	3,500 lbs.

TRAILER COUPLERS A Frame Type

- Painted body.
- Pre-drilled jack mounting holes.



ITEM NO.	BALL SIZE	CHANNEL SIZE	CLASS	BALL LOCK TYPE	LOAD RATING
TS-A1	2"	A Frame	III	External "U" bracket	5,000 lbs.
TS-A2	2 5/16"	A Frame	IV	Spring trigger	25,000 lbs. 10,000 GVW

TRAILER HITCH BALL BUSHINGS

- Used to reduce diameter of hole in draw bar

ITEM NO.	DESCRIPTION
220601	Hitch Ball Adaptor To Reduce Hole Size From 1" to 3/4"
220602	Hitch Ball Adaptor To Reduce Hole Size From 1 1/4" to 1"



HITCH BALL MOUNTS / DRAW BARS

- Black powder coat finish.
- 5/8" lock pin required.



ITEM NO.	BOX SIZE	BALL SHANK DIA.	A LENGTH	B DROP	C RISE	CAPACITY/TW
BMC-3001	2" x 2"	3/4"	8 1/4"	Straight	Straight	2000/200 lbs.
BMC-3002	2" x 2"	1"	10 1/2"	2"	3/4"	5000/500 lbs.
BMC-3003	2" x 2"	1"	13"	3 1/4"	2 1/4"	5000/500 lbs.
BMC-3004	2" x 2"	1"	11 1/2"	6"	4 3/4"	5000/500 lbs.

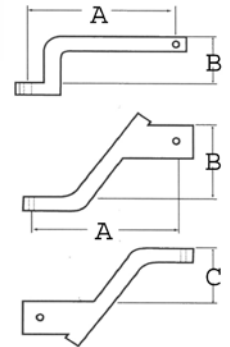

TRAILER JACKS

ITEM NO.	MOUNTING BRACKET TYPE	RATED CAPACITY	LIFT	HANDLE	ITEM NO.	MOUNTING BRACKET TYPE	RATED CAPACITY	LIFT	HANDLE
FJ-01-020	Tubular Swivel Retracted Dimension (A) 11 3/4" Retracted Dimension (B) 16 3/4"	2,000 lbs.	10"	Top Wind	TJ-701130	Double Lock Pin Swivel Jack Bolt on Mount <i>Supplied with grease fitting to grease gear.</i> Retracted Dimension (A) 13 1/2" Retracted Dimension (B) 22 1/2" Wheel Height Dimension (C) 6 3/4"	1,500 lbs.	10"	Side Wind Double 6" Wheel
FJ-05-070	Tubular Swivel <i>Supplied with grease fitting to grease gear.</i> Retracted Dimension (A) 12" Retracted Dimension (B) 16 1/2"	5,000 lbs.	10"	Side Wind 2	TJ-09-520*	A-Frame Jack Bolt on Mount Retracted Dimension (A) 7 3/4" Retracted Dimension (B) 20" <i>* Wheel or Foot may be required.</i>	2,000 lbs.	15"	Top Wind
FJ-05-570	Tubular Swivel <i>Supplied with grease fitting to grease gear.</i> Retracted Dimension (A) 15" Retracted Dimension (B) 20"	5,000 lbs.	15"	Side Wind 2	TJ-701057*	A-Frame Jack Bolt on Mount Retracted Dimension (A) 10" Retracted Dimension (B) 20" <i>* Wheel or Foot may be required.</i>	5,000 lbs.	15"	Top Wind
FJ-02-520	Retaining Ring Swivel Retracted Dimension (A) 14 1/2" Retracted Dimensions (B) 20 1/4"	2,000 lbs.	15"	Top Wind 4	TJ-701058*	A-Frame Jack Bolt on Mount <i>Supplied with grease fitting to grease gear.</i> Retracted Dimension (A) 7 1/2" Retracted Dimension (B) 22 1/2" <i>* Wheel or Foot may be required.</i>	1,000 lbs.	15"	Side Wind
TJ-06-01L	Double Lock Pin Swivel Jack Bolt On Mount <i>Supplied with grease fitting to grease gear.</i> Retracted Dimension (A) 13 1/2" Retracted Dimension (B) 21" Wheel Height Dimension (C) 6 3/4"	1,000 Lbs.	10"	Side Wind 2	TJ-701059*	A-Frame Jack Bolt on Mount Dimension (A) 7 1/2" Dimension (B) 22 1/2" <i>* Wheel or Foot</i>	2,000 lbs.	15"	Side Wind

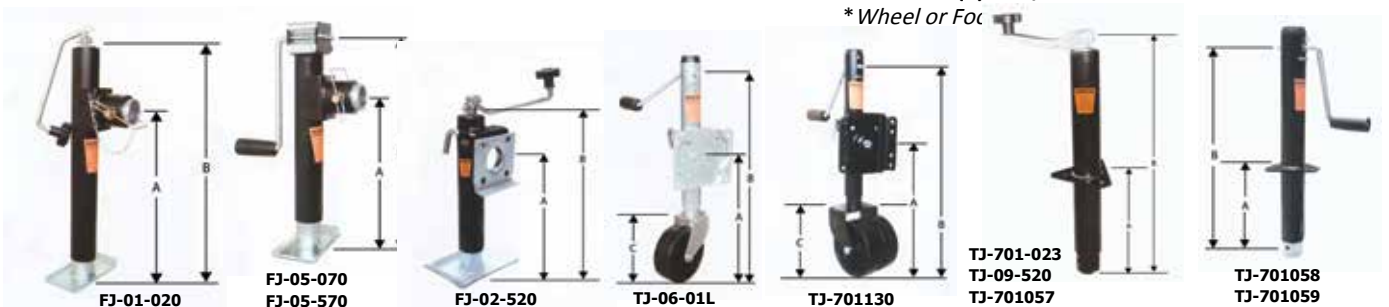



CASTORS AND FOOT PLATE

- For use with A frame trailer jacks.

ITEM NO.	LIFT CAPACITY	ADDITIONAL LIFT
----------	---------------	-----------------

TJ-701070 1,000 lbs. 7"
 ABS Castor with pin for TJ-701023, TJ-701058.

TJ-701071 1,200 lbs. 7"

ABS Castor with pin for TJ-09-520, TJ-701057, TJ-701059.

TJ-701072 2,000 lbs. 8 3/4"

Steel drop leg for TJ-701056, TJ-701057, TJ-701059.



TRAILER COUPLERS Channel Type

- Zinc coated body.
- Zinc plated locking mechanism.
- Smooth trigger mechanism for fast release and easy hook ups.
- May be padlocked.

ITEM NO.	BALL SIZE	CHANNEL SIZE	CLASS	LOAD RATING
TSZ-60A	1 7/8"	2"	II	2,000 lbs.
TSZ-60B	1 7/8"	2 1/2"	II	2,000 lbs.
TSZ-60C	1 7/8"	3"	II	2,000 lbs.
TSZ-60D	2"	2 1/2"	II	3,500 lbs.
TSZ-60E	2"	3"	II	3,500 lbs.
TSZ-60F	2"	2"	II	3,500 lbs.



TRAILER COUPLER LOCK

- Poly-bagged.
- Locks coupler locking lever to deter theft.
- Weather resistant cast body and chrome-plated locking pin.
- Supplied with 2 keys.

ITEM NO.	DESCRIPTION
TS-LOCK	Coupler Lock



TRAILER HITCH RECEIVER LOCKS

- Poly-bagged.
- Self locking (can be locked without key).
- Supplied with weather resistant protective cap.
- Chrome plated pin for weather resistance.
- Supplied with 2 keys.

ITEM NO.	RECEIVER PIN DIA.	DESCRIPTION
5201-270LK	1/2"	1 1/4" x 1 1/4" 3 1/4" Useable Length
5202-272LK	5/8"	2" x 2" Receiver 3 1/2" Useable Length



RUBBER TIE DOWNS Made in Canada

- 100% High Quality EPDM Rubber.
- Straps stretch to 2 1/2 times original length.
- ISO 9001:2000 Quality Standards.
- Plated hooks to resist rust.
- Stamped with 50 lb. SWL as required by DOT.



ITEM NO.	SIZE
SH09	9"
SH15	15"
SH20	20"
SH30	30"
SH500	Snappi Hookers Display - Consisting of:
	14 Each: SH09 9" Strap
	12 Each: SH15 15" Strap
	12 Each: SH20 20" Strap
	12 Each: SH30 30" Strap

1 Plastic Display Board with Hardware.



RUBBER TIE DOWNS Snappi Hooker Black Adjustable - Made in Canada

- Injected molded EPDM meaning no imperfections.
- 2-1/2 times safe stretch non-cracking.
- Meets DOT requirements.
- Adjustable to allow several hook positions.

ITEM NO.	SIZE	NO OF ADJUST	DESCRIPTION
SH20ADJ	20"	3	Adjustable Tarp Strap
SH30ADJ	30"	4	Adjustable Tarp Strap

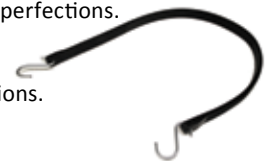

**RUBBER TIE DOWNS - Snappi Hooker
Camo - Made in Canada**



- Injection molded EPDM meaning no imperfections.
- 2 1/2 times safe stretch, non-cracking.
- Meets DOT safe working load limit.
- Made to ISO9001/AS9100 quality certification.
- Stamped with 50 lb. SWL as required by DOT.
- Ideal for hunting and other outdoor activities.

ITEM NO.	SIZE	NO OF ADJUSTMENTS
SH20CAMO	20"	3
SH30CAMO	30"	4



**RUBBER TIE DOWNS - Snappi Hooker
Cold Weather Model - Made in Canada**

- Easy identifiable blue colour.
- Operational to -40°C
- Injection molded EPDM meaning no imperfections.
- 2 1/2 times safe stretch, non-cracking.
- Meets DOT safe working load limit (no others do).
- Made to ISO9001/AS9100 quality certification.
- Stamped with 50 lb. SWL as required by DOT

ITEM NO.	SIZE
SH09CO	9"
SH15CO	15"
SH20CO	20"
SH30CO	30"



ITEM NO.	DESCRIPTION
SH500CO	COLD WEATHER BLUE DISPLAY Consists of: 14 - SH09CO, 12 - SH15CO, 12 - SH20CO, 12 - SH30CO
SH500COF	SAME AS ABOVE IN FRENCH

TIE DOWNS - Shock Cord

- Fabric covered.
- Vinyl dipped steel hooks.
- Non-marking.

ITEM NO.	DESCRIPTION
BC-12	12"
BC-18	18"
BC-24	24"
BC-30	30"
BC-36	36"



RUBBER TIE DOWNS

- Heavy duty EPDM to withstand ultra violet rays.
- Complete with "S" hooks.
- Marked with WLL 45 lbs.

ITEM NO.	SIZE
PS-10	10"
PS-15	15"
PS-21	21"
PS-31	31"
PS-41	41"



POLYPROPYLENE TOW ROPE

- Ideal for emergency pulling.
- Polypropylene rope with two forged hooks.
- Maximum vehicle weight: 4250 lbs.
- Breaking load: 8500 lbs.
- Packaged in reusable zippered display pouch.

ITEM NO.	DESCRIPTION
TR78-14	7/8" X 14' With Forged Hooks

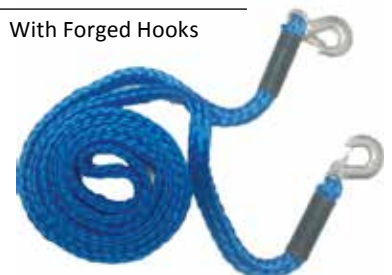

SHOCK CORD

- Make your own custom length tie-downs.
- Fabric covered cord stretches to 175% of cut size.
- Load Limit: 16 lbs. (7.25 kg)

ITEM NO.	DESCRIPTION
BC8-75M	5/16" (8 mm) Cord on 246' (75 m) Spool
BCHOOK-3.2	Hooks for 5/16" Cord (Sold in Bags of 100 Only)





TIE DOWN - Sport Type Quick Release

- Heavy duty nylon web.
- Ideal for roof racks, motorcycles, etc.
- 2 PVC coated "S" hooks included.



ITEM NO.	SIZE	APPROX. STRENGTH
PSTD-11	1" x 5 1/2'	2,000 lbs.
PSTD-11CP-2	1" x 5 1/2'	2,000 lbs. (2/pack)
PSTD-12	1" x 10'	2,000 lbs.

TIE DOWN - Ratchet Type

- Heavy duty nylon web.
- Ideal for roof racks, motorcycles, boats.
- Quick secure cinching.



ITEM NO.	SIZE	APPROX STRENGTH
PSTD-14	1" x 12'	2,000 lbs. with "S" Hooks
PSTD-16	1" x 16'	2,000 lbs. with "J" Hooks
PSTD-20	1 1/2" x 20'	4,000 lbs. with "J" Hooks

HEAVY DUTY CARGO LASHES

- Ratchet type.
- With heavy duty webbing, made with Terylene.
- 30' x 2".

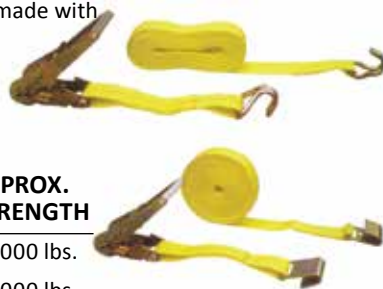

ITEM NO.	TYPE	APPROX. STRENGTH
PCL-21JHD	"J" Hook	10,000 lbs.
PCL-21FHD	Flat Hook	10,000 lbs.

FLAT NYLON (EMERGENCY) TOW STRAP

- Ideal for emergency pulling.
- Strong nylon webbing.
- Stretches to absorb shock.
- Two drop forged hooks.



ITEM NO.	SIZE	SWL
NS-20	2' X 25'	8,500 lbs.

CARGO NET - Expandable

- Size 72" x 96". Fits standard PU truck box.
- Complete with 28 non-marking ABS hooks.
- Strong fabric covered rubber cords.

ITEM NO.	DESCRIPTION
CN-7296	72" X 96" Cargo Net



CARGO NET

- 15" x 15" expandable to 32" x 32".
- ABS tie-down hooks.
- Suitable for snow mobiles and ATV's.

ITEM NO.	DESCRIPTION
*CN-1515	Expandable Cargo Net

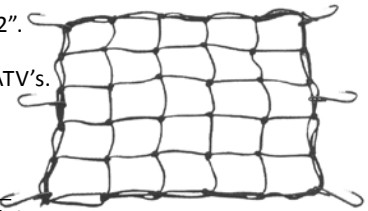

**FOB DARTMOUTH, NS ONLY*

PLASTIC BONDER™

- Quick setting urethane adhesive system
- Ideal on thermoset carbon fibre composites, thermo plates, coated metals, concrete and more
- Sets in 15 minutes
- Has tensile strength of 3770 PSI
- Supplied in 25 ml (1 oz) syringe
- Very useful in auto body repair
- Carded



ITEM NO.	DESCRIPTION
50133	Plastic Bonder™ Dries Tan
50139	Plastic Bonder™ Dries Black

MARINEWELD™

- 2 part epoxy cold weld system for bonding different or similar surfaces
- Ideal for aluminum, metal, composites, fibreglass etc.
- Sets in 20-25 minutes at room temperature
- 28 g (1 oz) Resin, 28 g (1 oz) hardener
- Carded



ITEM NO.	DESCRIPTION
8272	MarineWeld™ 56 g (2 oz) Resin/Hardener Strength 3900 PSI, dries dark grey
50172	MarineWeld™ Syringe Strength 3200 PSI, dries white



WATERWELD™

- Makes repairs under water.
- Works on wet or dry surfaces.
- Hardens 20 minutes.
- Useable on metals, wood, fiberglass, masonry, ceramics and many plastics.

ITEM NO.	DESCRIPTION
8277	56g (12 oz.) Tube - Carded



COLDWELD™ COMPOUND

- Repairs, fills, bonds.
- Useable on iron, steel, copper, aluminum, brass, bronze, pewter, wood, porcelain, ceramic, plastic.
- Can be drilled, machined or ground.
- Not affected by gas, oil or water.
- Each card contains one 1 oz. tube of steel and one 1 oz. tube of hardener.



ITEM NO.	DESCRIPTION
8265-S	Cold Weld Compound - Carded

MINUTEWELD™

- Quick setting epoxy
- Multi purpose plastics, ceramic, glass etc.
- Supplied in 25 ml (1 oz) syringe
- Strength 4400 PSI
- Carded



ITEM NO.	DESCRIPTION
50101	MinuteWeld™ Dries Clear

CLEARWELD™

- Dries Clear
- Suitable for tile, plastics, ceramic, glass, wood & more
- Supplied in 25 ml (1 oz) syringe
- Strength 4400 PSI
- Carded



ITEM NO.	DESCRIPTION
50112	ClearWeld™ Dries Very Clear

PLASTICWELD™

- Quick setting epoxy
- Ideal for plastics, abs, glass, PVC, vinyl and most composites
- Strength 4400 PSI
- Supplied in 25 ml (1 oz) syringe
- Carded



ITEM NO.	DESCRIPTION
50132	PlasticWeld™ Dries Off White



PLASTICWELD™

- Works on rigid and flexible plastic
- Can be used on ABS, PVC, CPVC pipes
- Suitable for auto trim and bumpers
- Works on fibreglass & vinyl siding
- Bonds instantly, sets up in 20-25 minutes
- Supplied in 52 ml (2 oz) stick
- Carded



ITEM NO.	DESCRIPTION
8237	PlasticWeld™

EXTREMEHEAT™

- Metallic paste
- Withstands 2400°F/1300°C
- Ideal for holes, cracks, exhaust manifolds, mufflers, outdoor grills
- Supplied in a 85 g (3 oz) container



ITEM NO.	DESCRIPTION
37901	ExtremeHeat™ Bonds & Fills

KWIK BOND

- Bonds in 4 minutes.
- Ideal for hobbies, crafts, household, plumbing and automotive repairs.
- Withstands temperatures of up to 300°F.
- Soap and water clean up.



ITEM NO.	DESCRIPTION
8276	"Kwik" Bond (1 oz.) Tube - Carded

COLD WELD COMPOUND™ - Syringe

- Repairs, fills, bonds
- Useable on iron, steel, copper, aluminum, brass, bronze, pewter, wood, porcelain, ceramic, plastic
- Can be drilled, machined or ground
- Not affected by gas, oil or water
- 28 g (1 oz) Steel, 28 g (1 oz) hardener
- Carded



ITEM NO.	DESCRIPTION
50165	Cold Weld Compound Syringe
8265-S	Cold Weld Compound

KWIKWELD™

- Quick setting steel enforced epoxy
- Good for house, auto, plumbing, marine & crafts
- 6 minute set-up
- Strength 2424 PSI
- Carded



ITEM NO.	DESCRIPTION
50176	KwikWeld™ Dries Dark Grey, 25 ml (1 oz) Syringe
8270	KwikWeld™ 2 X 141.8 g (2 x 5 oz) Syringe

SUPERWELD™ GLUE

- Great for automobiles, rubber, plastic, vinyl, leather, cloth
- Can be used on interior rear view mirrors
- Brush-on cap
- Dries in seconds
- Carded



ITEM NO.	DESCRIPTION
33106	SuperWeld™ Glue 6 g (0.2 oz)
33120	SuperWeld™ 20 g (0.7 oz)

HIGHHEAT™

- Suitable for high heat areas, exhaust manifolds, mufflers, tail pipes, blocks up to 450°
- 1 hour set time
- Supplied in a 57 ml (2 oz) tube
- Carded



ITEM NO.	DESCRIPTION
8297	HighHeat™ Mastic Epoxy Dries Grey

PERMALOCK™ - Threadlocker

- Seals threads against leakage and prevents rust & corrosion
- Choose between medium strength (removeable) or high strength (more permanent)
- Carded

ITEM NO.	DESCRIPTION
24206CAN	Blue Medium Strength Thread Locker 6ml (0.02 oz)
24236	Blue Medium Strength Thread Locker 36 ml (1.3 oz)
27106CAN	Red High Strength Permanent Thread Locker 6 ml (0.02 oz)
27136	Red High Strength Permanent Thread Locker 36 ml (1.3 oz)



TANKWELD™ - Putty

- Repairs all metals
- Approved by NSF
- Cures in 1 hour
- Supplied in 28.4 g (1 oz) stick
- Carded

ITEM NO.	DESCRIPTION
8217	TankWeld™



WOODWELD™

- 2 Part quick setting wood epoxy adhesive
- 6-8 minute curing time
- Repairs anything made of wood
- Will not shrink, separate, crack or expand
- Supplied in 2 x 21.5 g (0.75 oz) tubes
- Carded

ITEM NO.	DESCRIPTION
8251	WoodWeld™



SILICONE GASKET MAKERS RTV

- 100% Silicone
- 1 Hour set time
- 85 g (3 oz)
- Carded

ITEM NO.	DESCRIPTION
31310	Clear RTV Waterproof
31314	Red Hi-Temp Ideal for Engine Parts
31316	Blue All Purpose
31319	Black For Windows Weather Strip
32327	Grey Ultimate, for High Torque (Import)
32329	Black Ultimate, for High Torque, Hi-Temp



KWIKWOOD™

- Repairs anything made of wood
- Suitable for indoor and outdoor
- Cures in 1 hour
- 2 part epoxy
- Cures light tan
- Carded

ITEM NO.	DESCRIPTION
8257	KwikWood™ 28.4 g (1 oz) Tube
50151	WoodWeld™ 25 ml (0.85 oz) Syringe



INDUSTRO WELD™

- Repairs, fills, bonds.
- Useable on iron, steel, copper, aluminum, brass, pewter, wood, porcelain, ceramic, plastic.
- Can be drilled, machined or ground.
- Not affected by gas, oil or water.
- Each package includes 1 x 5 oz. tube of steel and 1 x 5 oz. tube of hardener.

ITEM NO.	DESCRIPTION
8280	"Industro Weld" - Boxed 5 Oz. Of Each Tube



FIBERFIX® TOTAL REPAIR GLUE™

- Cyanoacrylate glue cures by pressure and light
- Tube includes UV light to speed curing process
- Fills and seals gaps, cracks and holes
- Carded

ITEM NO.	DESCRIPTION
33301	5g (.176 oz) Tube on Card

FIBERFIX® EXTREME GLUE™

- Withstands up to 2600 lbs of force
- Cures in as little as 30 seconds
- Flexible bond
- Use on metal, glass, rubber, rock, wood and more
- Carded

ITEM NO.	DESCRIPTION
33400	15g (.53 oz) Tube on Card

FIBERFIX® REPAIR TAPE™

- 100 times stronger than duct tape (hardens like steel)
- Dip in water and wrap - cures in 5-10 minutes
- Sandable/paintable when cured
- Pressure rating up to 60 PSI, temperature from -30°F - 300°F (-1°C - 149°C)
- Use on pipes, tools, frames, hoses, equipment and more
- Boxed with hanger

ITEM NO.	DESCRIPTION
38101	1" x 40" Roll
38201	2" x 50" Roll

FIBERFIX® HEAT WRAP PRO™

- Just remove from pouch, wrap and apply heat
- Seals cracks and holes on all parts of exhaust system
- Rated for up to 1500°F (815°C)
- Boxed with hanger

ITEM NO.	DESCRIPTION
38550	2" x 35" Roll

FIBERFIX® HEAT WRAP™

- High temp version of repair tape
- Dip in water, wrap and apply heat to cure (1-5 hours)
- Sandable and paintable when cured
- Rated for up to 850°F (454°C)
- Use on exhaust pipes, mufflers, hot water pipes and other high temperature repairs.
- Boxed with hanger

ITEM NO.	DESCRIPTION
38501	2" x 70" Roll

FIBERFIX® RIGID PATCH™

- Peel and stick application
- Sandable and paintable after curing
- includes 3 patch (1 each: 3"x3", 2"x8" and 5"x5")
- Use on gutters, garbage barrels, water tanks, boats, canoes, automotive body and more
- Boxed with hanger

ITEM NO.	DESCRIPTION
39000	Kit With 3 Patches

FIBERFIX® 10X TAPE™

- Strongest all-purpose tape on the planet
- 10 Times stronger than duct tape - virtually un-tearable
- Water resistant
- Mini knife included

ITEM NO.	DESCRIPTION
39501	2" x 60' Roll



AQUASEAL - Repair Adhesive For Neoprene

- Urethane rubber compound for repair to all flexible neoprene products such as wet suits and rafts.
- Unaffected by heat or solvents.
- Holes up to 1" can be repaired without patches.

ITEM NO.	DESCRIPTION
AQUA-28	Aquaseal 28 ml Tube - Carded



AUTOMOTIVE GOOP

- Used to repair leather, rubber or vinyl.
- Carded 109.4 ml tube.
- Dries clear.

ITEM NO.	DESCRIPTION
160034	Automotive Goop



BRUSH-ON ELECTRICAL TAPE

- Forms a tough flexible coating on metal, rubber, plastic.
- Quick dry formula.
- Can be used in hard to reach places.
- Used to waterproof connections.
- Absorbs vibrations, prevents screws from loosening.

ITEM NO.	COLOUR
NA55	Black
NA58	Red



PLUMBER'S GOOP

- Can be used in place of silicone on PVC, porcelain, gutters, etc.
- Carded 109.4 ml tube.
- Dries clear.

ITEM NO.	DESCRIPTION
150034	Plumber's Goop



AMAZING GOOP

- All round adhesive, repairs ceramics and pottery.
- Carded 29.5 ml tube.

ITEM NO.	DESCRIPTION
140034	Amazing Goop



SEAL-ALL - Repair Kit In A Tube

- Seals, bonds, insulates, waterproofs.
- Bonds wood, metal, glass, plastic, rubber and fabric.
- Unaffected by gasoline, oil or alcohol.
- Ideal for gas tank and plumbing repairs.
- Dries in minutes.

ITEM NO.	DESCRIPTION
SEAL-22	29.7 ml (1 fl. oz.) Tube - Carded
SEAL-60	60 ml (2 fl. oz.) Tube - Carded



MARINE GOOP

- Weather proof and UV resistant.
- Used as a sealant or adhesive.
- Carded 109.4 ml tube.
- Dries clear.

ITEM NO.	DESCRIPTION
170034	Marine Goop





HOUSEHOLD GOOP

- Replaces all other types of glue.
- Mends, seals and protects; creates a tough flexible waterproof bond on rain wear, shoes and plumbing. It can repair worn insulation, cover rust spots, lock loose nuts-bolts and adheres to brick & cement.
- Carded 109.4 ml tube.
- Dries clear.



ITEM NO.	DESCRIPTION
130034	Household Goop

SHOE GOO

- Designed to repair shoes, can be used on leather, rubber, canvas and most composites.
- Carded 29.5 ml tube.



ITEM NO.	DESCRIPTION
110134	Shoe Goo

CRAFT ADHESIVE

- Industrial strength craft adhesive.
- Photograph safe.
- Waterproof.
- Washer/Dryer safe.
- Dries clear.
- Paintable.
- 29.5 ml Tube.
- Available in counter top display of 24.
- Dries clear.



ITEM NO.	DESCRIPTION
230025	E6000 Craft Adhesive

BENCH VISES



- Reliable, economical.
- Replaceable steel jaws.
- Suitable for most machine shops.

ITEM NO.	BASE TYPE	WIDTH OF JAW	OPENING	WEIGHT
V-0404	Stationary	4"	4"	21 lbs.
V-0505	Stationary	5"	5 1/2"	37 lbs.
V-0606	Stationary	6"	6"	65 lbs.
V-0808	Stationary	8"	9"	88 lbs.
*V-0404-SB	Swivel	4"	4"	24 lbs.

*FOB SURREY, BC ONLY



MULTI-PURPOSE BENCH VISE

- Removable jaws.
- Head revolves 360° to allow use of regular jaws or pipe jaws.
- 3" x 3 1/2" anvil.

ITEM NO.	BASE TYPE	WIDTH OF JAW	OPENING	WEIGHT
V2125	Swivel	5"	5"	65 lbs.



DRILL PRESS VISES

- For general drill press drilling.
- Replaceable jaws.
- Cast iron body w/plated steel screw.
- Slotted base for easy mounting.

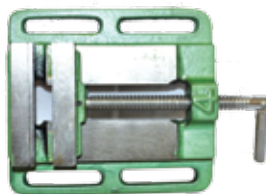

ITEM NO.	WIDTH OF JAW	OPENING	DEPTH	WEIGHT
DPV-4	4"	3 3/4"	7/8"	3.5 kg
DPV-6	6"	5 3/4"	1"	6.1 kg

GEAR PULLERS

- Chrome plated jaws.
- Double ended (inside or outside pulling).
- Adjustable jaw - two positions.

ITEM NO.	MAX. SPREAD	REACH	CAPACITY
----------	-------------	-------	----------

Two Jaw Type:

141-3	3"	2 1/2"	3 tons
141-4	4"	3 1/2"	4 tons
141-6	6"	5 1/4"	6 tons
141-8	8"	10 1/2"	10 tons

Three Jaw Type:

142-3	3"	2 1/2"	3 tons
142-4	4"	3 1/2"	4 tons
142-6	6"	5 1/2"	6 tons
142-8	8"	10 1/2"	10 tons



C CLAMPS

- Inexpensive general purpose.
- Malleable iron construction.
- Zinc plated screw.
- Swivel button.

ITEM NO.	MAX. OPENING	WEIGHT EACH
----------	--------------	-------------

141	1"	0.25 lb
142	2"	0.5 lb
143	3"	0.75 lb
144	4"	1.25 lbs
146	6"	2.0 lbs
148	8"	3.0 lbs



C CLAMPS - Heavy Duty

- Malleable Iron.
- Painted black, screw and handle are chrome plated.
- Replaces our CC series.

ITEM NO.	DESCRIPTION	THROAT DEPTH	WEIGHT EACH
AL302-2	2" Capacity C Clamp	1"	0.5 lb
AL302-3	3" Capacity C Clamp	1-11/16"	1 lb
AL302-4	4" Capacity C Clamp	1-15/16"	1.75 lbs
AL302-6	6" Capacity C Clamp	2-7/16"	2.25 lbs
AL302-8	8" Capacity C Clamp	2-7/8"	2.75 lbs





BOLT CUTTERS - Made in Japan



- All purpose high quality bolt cutters.
- Drop forged jaws made from carbon tool steel.
- Jaws carefully heat treated for maximum strength and wear resistance.
- 12" - 18" clipper cut; 24" - 42" centre cut jaws.
- High strength tubular handles with rubber grips.
- Adjustable jaw.
- Spare jaws available.

ITEM NO.	LENGTH	CAPACITY	WEIGHT EACH
BC-0735 (Previously HP-002)	14"	1/4" (6mm)	2.25 lbs.
BC-0745 (Previously HP-003)	18"	5/16" (8mm)	3.75 lbs.
BC-0760 (Previously HP-004)	24"	3/8" (10mm)	6.0 lbs.
BC-0775 (Previously HP-005)	30"	1/2" (13mm)	9.25 lbs.
BC-0790 (Previously HP-006)	36"	11/16" (14mm)	14.0 lbs.
BC-0710 (Previously HP-007)	42"	5/8" (16mm)	



MCC BOLT CUTTER (Off Set Type) Made In Japan

- Angular jaws made of heat treated carbon steel
- 30 degree offset to allow flush cut and allow visual of item to cut
- For use on soft-medium metals.
- Parts available

ITEM NO.	DESCRIPTION
AC-0060	24" Offset Bolt Cutter
ACE-0060	Replacement Jaws



BOLT CUTTER (Ratchet Type) Made In Japan



- Drop forged jaws.
- High strength tubular handles with rubber grip.
- Ratchet action allows using in restricted space.
- Cutting capacity 1/2" (19 HRC) 14/32" (36 HRC).

ITEM NO.	DESCRIPTION
RBC-3213	31" Ratchet Bolt Cutter
RBCE-3213	Replacement Jaws



MCC MINI BOLT CUTTERS Made In Japan

- All purpose high quality bolt cutters.
- PVC covered handles.
- Heat treated jaws.
- Spring return handle.

ITEM NO.	DESCRIPTION
MC-0020	Standard mini bolt cutter, capacity 4 mm soft steel (Previously HP-014)
MCS-0020	Short jaw designed to limit capacity, suitable for 4mm soft steel or 2 mm HRC
SUSMC-02	Suitable for up to 4mm soft steel, made of stainless steel to prevent corrosion
ME-0020	End cutter design, capacity 3.5mm soft steel, 2mm HRC 20
MN-0022	40° Angle cutter, capacity 3.5mm maximum diameter or HRC 20



MC-0020



MCS-0020



SUSMC-02



ME-0020



MN-0022





WIRE ROPE CUTTERS
Made in Japan



- Jaws designed specially for cutting wire rope.
- By-passing cutting jaws.
- Same quality features as “MCC” Bolt Cutters.



ITEM NO.	LENGTH	CAPACITY	WEIGHT EACH
WC-0260 (Previously HP-023)	24"	3/8"	5.0 lbs.
WC-0290 (Previously HP-025)	36"	5/8"	13.5 lbs.

MCC STEEL STRAP CUTTER
Made in Japan

- Specially designed to slip under and hold tight steel or plastic strapping and reduce spring action of cut strapping.

ITEM NO.	DESCRIPTION	CAPACITY
SC-0200 (Previously HP-030)	9" Strap Cutter	.035" (.9mm)
SC-0201 (Previously HP-031)	18" Strap Cutter	.047" (1.2mm)



MCC HYDRAULIC HOSE CUTTER & CABLE CUTTER Made in Japan

- Designed to cut aluminum or soft copper strands as well as re-enforced hydraulic hose.
- By-pass blades create clean cuts and hook blade draws material into cutting area.
- Replacement jaws available.



ITEM NO.	LENGTH	CAPACITY	WEIGHT EACH
CC-0302	30"	1 3/16"	8.0 lbs.

REBAR CUTTER AND BENDER
Made in Japan



- Quality tool specially designed for cutting and bending rebar and other soft steels.
- Maximum capacity 5/8" (13mm - 16mm).
- Replacement cutter jaws available.
- Suitable to cut Grade 40 and Grade 60.
- New heavier construction.
- No adjustments required for rebar sizes.

ITEM NO.	DESCRIPTION	WEIGHT EACH
SCB-16	Rebar Cutter Bender	38 lbs.
SCBE-16	Replacement Jaws	



MCC REBAR CUTTER & BENDER
Made in Japan

- Lightweight (26 lbs) and easy to handle.
- Suitable for cutting #3 and #4 rebar (3/8" - 1/2").
- Jaw has 2 cutting openings.
- Maximum 1/2" capacity.



ITEM NO.	DESCRIPTION
CB-0213	Rebar Cutter/Bender
CBE-0213	Replacement Jaws

MCC THREADED ROD CUTTER
Made in Japan

- Designed to cut threaded mild steel.
- Does not damage threads (no thread repair).
- Dies can be flipped over to allow double the usage.

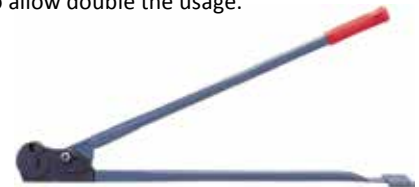

ITEM NO.	DESCRIPTION	WEIGHT
AB-3U	3/8" UNC Threaded Rod Cutter	8 lbs
ABE-3U	3/8" Replacement Dies for AB-3U, AB-43U	
*AB-43U	3/8", 1/2" Threader Rod cutter	15 lbs
ABE-4U	1/2" Replacement Dies	



(Metric Sizes Available)

*FOB SURREY, BC ONLY

BOLT CUTTERS

- Drop forged high alloy steel jaws.
- Comfortable cushion grip handles.
- Replaceable jaws.
- Adjustable jaws.



ITEM NO.	LENGTH	CAPACITY	WEIGHT EACH
C11-14	14"	1/4" (7mm)	1.98 lbs.
C11-18	18"	5/16" (8mm)	3.3 lbs.
C11-24	24"	3/8" (10mm)	5.28 lbs.
C11-30	30"	1/2" (13mm)	8.14 lbs.
C11-36	36"	5/8" (16mm)	11.60 lbs.

SWAGER AND CABLE CUTTER

- For crimping soft metal (aluminum, copper) sleeves and stops.
- Heat treated alloy joints.
- Crimping capacity 1/16" to 3/16" diameter.
- Length: 25 1/2".



ITEM NO.	DESCRIPTION
HWP-24	Swager and Cable Cutter

MCC

SPARE JAWS FOR MCC TOOLS Made in Japan

MCC

ITEM NO.	DESCRIPTION	WEIGHT EACH
BCE-0035 (Previously HE-124)	14" Bolt Cutter Jaws	1.0 lbs.
BCE-0045 (Previously HE-125)	18" Bolt Cutter Jaws	1.5 lbs.
BCE-0060 (Previously HE-126)	24" Bolt Cutter Jaws	2.25 lbs.
BCE-0075 (Previously HE-127)	30" Bolt Cutter Jaws	3.5 lbs.
BCE-0090 (Previously HE-128)	36" Bolt Cutter Jaws	5.0 lbs.
BCE-0710 (Previously HE-129)	42" Bolt Cutter Jaws	7.0 lbs.
WCE-0260 (Previously HE-138)	24" - 3/8" Wire Rope Cutter Jaws	2.0 lbs.
WCE-0290 (Previously HE-140)	36" - 5/8" Wire Rope Cutter Jaws	4.0 lbs.
CBE-0216 (Previously HE-149)	5/8" Cap. Rod Cutter/ Bender Jaws for Model CB-16, HP-131,	6.5 lbs.
CCE-0302	30" Hose Cutter Replacement Jaws	3.0 lbs.



BCE-0035
BCE-0710



CBE-0216



CCE-0302

PVC PIPE CUTTER Made by MCC Japan

- Suitable for PVC pipe, anti-shock PVC, PVC conduit and polyethylene gas pipe.
- Alloy body saves weight
- V-groove shaped jaw holds pipe in place. Suitable for 1/4" - 1 5/8" PVC pipe.
- Replacement blades available.



ITEM NO.	DESCRIPTION
VC-0334	1 1/3" (34 mm) Cutting Capacity Ratcheting PVC Pipe Cutter
VCE-0334	Replacement Blade
VC-0342A	1 5/8" (42 mm) Cutting Capacity Ratcheting Pipe Cutter
VCE-0342	Replacement Blade
VC-0363	2 1/2" (63 mm) Cutting Capacity Ratcheting Pipe Cutter
VCE-0363	Replacement Blade



AVIATION TIN SNIPS

- Professional quality drop forged, chrome vanadium steel.
- ABS coated handle, colour coded.



ITEM NO.	DESCRIPTION
ATS-S	Straight Cut, Yellow
ATS-L	Left Cut, Red
ATS-R	Right Cut, Green

TIN SNIPS - Straight Pattern

- Non-slip PVC handles.
- Induction hardened cutting edge hardened to HRC 54-58.
- Assembled with nylon insert locking nut to assure handle tightness.
- Meets Federal specification ANSI/ASME B107.16 1985.

ITEM NO.	DESCRIPTION
TS-07	7" Straight Pattern Tin Snip
TS-10	10" Straight Pattern Tin Snip
TS-12	12" Straight Pattern Tin Snip



FLARE KITS

- Supplied in strong ABS molded case.
- Kits include tubing cutter and flaring tool.
- Flares from 3/16" to 5/8".

ITEM NO.	DESCRIPTION
TF-270	3 Pce. Flare Kit, Incl. Tube Cutter And 2 Pce. Flare Tool, Flares 3/16" To 5/8"
DFT-210	10 Pce. H.D. Flare Kit With DoubleFlare Adapters 3/16". 1/4", 5/16", 3/8", 7/16", 1/2", 5/8", Tubing Cutter Is Supplied With Extra Cutter Wheel In Handle



TUBING CUTTERS - Economy

- Alloy steel cutter wheels.
- Grooved rollers to allow close to flare cuts.
- Suitable for use on copper, aluminum and brass.
- Attractively blister carded.



ITEM NO.	DESCRIPTION	MIN. CAP.	MAX. CAP.
TC-110B	Standard Tube Cutter	1/8"	1 1/8"
TC-120A	Mini Tube Cutter	1/8"	7/8"

Replacement Cutter Wheels

TC-BLB	Cutter Wheel For TC-110B 2/Card
TC-BLA	Cutter Wheel For TC-120A 2/Card
TC-111BL	Cutter Wheel For DFT-210 Cutter

HEAVY DUTY STEEL PIPE WRENCHES

- Forged carbon steel jaws, ductile steel housing.
- Precision milled teeth.



ITEM NO.	SIZE	DESCRIPTION
111-08	8"	Heavy Duty Pipe Wrench
111-10	10"	Heavy Duty Pipe Wrench
111-12	12"	Heavy Duty Pipe Wrench
111-14	14"	Heavy Duty Pipe Wrench
111-18	18"	Heavy Duty Pipe Wrench
111-24	24"	Heavy Duty Pipe Wrench

HEAVY DUTY ALUMINUM PIPE WRENCHES

- Lightweight and strong.



ITEM NO.	SIZE	DESCRIPTION
113-14	14"	Aluminum Handle Pipe Wrench
113-18	18"	Aluminum Handle Pipe Wrench
113-24	24"	Aluminum Handle Pipe Wrench



HEAVY DUTY STEEL PIPE WRENCHES



- Monoblock cast iron handle.
- Lower jaw (heel jaw) forged and tempered, properly seated so as to prevent load on pin.
- Upper jaw (hook jaw) forged and dual heat treated.
- Manufactured to U.S. Specifications GGG-W-651 E Type II Class A.



ITEM NO.	LENGTH	MAX PIPE SIZE
102-0800	8"	1"
102-1000	10"	1 1/2"
102-1200	12"	2"
102-1400	14"	2"
102-1800	18"	2 1/2"
102-2400	24"	3"
102-3600	36"	5"
102-4800	48"	6"

ALUMINUM PIPE WRENCHES

- Monoblock handle in light aluminum alloy of great resistance.
- Manufactured to U.S. Specifications GGG-W-651 E Type II Class C.



ITEM NO.	LENGTH	MAX PIPE SIZE
104-1000	10"	1 1/2"
104-1400	14"	2"
104-1800	18"	2 1/2"
104-2400	24"	3"
104-3600	36"	5"
104-4800	48"	6"

OFFSET ALUMINUM PIPE WRENCHES

- Monoblock handle of heat treated light aluminum alloy.
- Physical shape allows operation in narrow quarters where pipe is close to the wall and where small turning angle is available.
- Manufactured to US specifications GGG-W-651E Type II Class C.



ITEM NO.	LENGTH	MAX PIPE SIZE
105-1400	14"	2"
105-1800	18"	2 1/2"

*Please note that SUPER-EGO 102, 104 and 105 Series jaws may be interchangeable with Rigid.

BOX JOINT PLIERS



- Drop forged from chrome vanadium steel.
- Double hardened jaws.
- Jaws remain parallel at all times.
- Excellent ability for gripping pipe.
- Handle design prevents finger pinch.
- Can be operated with one hand.
- PVC coated handles for comfort.
- Countertop display: **no charge when 12 units ordered.**



ITEM NO.	DESCRIPTION	CAPACITY
522-1000	10" Box Joint Pliers	1 1/4"

CONCRETE WIRE NIPPER

- Drop forged steel.
- PVC coated handles.
- Heat treated cutting edges.
- Long handles provide added leverage.



ITEM NO.	DESCRIPTION	LENGTH
507-0900	Concrete Wire Nipper	9"

STRAP WRENCH - Nylon Strap

- The ideal wrench for working on chrome plated and plastic pipes.
- Commonly used in garages to remove oil filters, spindles, etc.



ITEM NO.	HANDLE LENGTH	MAX PIPE SIZE	STRAP LENGTH
108-12LO	12"	8"	35"

UTILITY CHAIN WRENCH Reversible

- Specially designed for easy operation in tight corners where other wrenches can not be used.
- Totally forged, with dual heat treatment.
- Due to the special design of the teeth, allows the pipe to be tightened or released alternately without changing the position of the wrench.



ITEM NO.	HANDLE LENGTH	MAX PIPE SIZE	CHAIN
107-1200	12"	4"	17 1/2"

TONGUE CHAIN WRENCHES



- Manufactured to U.S. Specifications GGG-W-651 E Type III Class A.



ITEM NO.	OVERALL HANDLE LENGTH INCLUDING JAW	PIPE SIZE CAPACITY	CHAIN LENGTH INCL. LINK
*103-3200	37"	4"	23"
*103-3300	44"	6"	32"
*103-3400	50 1/2"	8"	40 1/2"

***FOB SURREY, BC ONLY**

TUBING CUTTERS
For Copper, Stainless Steel and Plastic

- Industrial quality.

ITEM NO.	DESCRIPTION	MIN. CAP.	MAX CAP.
722	Mini	1/4"	7/8"
725	Standard	1/8"	1 1/8"
*726	Standard	1/2"	2"
*728	Mini-Max	1/8"	1 1/8"
735	Telescopic.	1/4"	1 3/8"
*750	Quick Action	1/4"	2 5/8"
*751	Quick Action.	2"	5"

Please note Item No. 725, 726, 735, 750 all include: 1 cutter for copper plus 1 cutter for plastic.

***FOB SURREY, BC ONLY**



PIPE CUTTERS



- To cut steel and cast iron pipes.

ITEM NO.	MINIMUM CAPACITY	MAXIMUM CAPACITY
701-0100	1/8"	1 1/4"
701-0200	1/8"	2"
710-0400	2"	4"

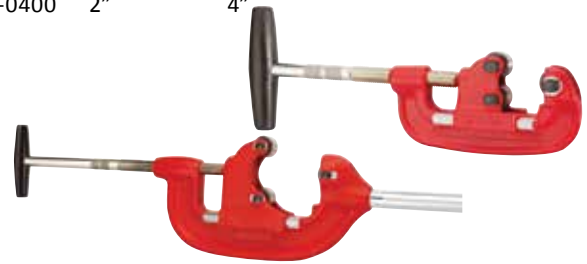

PVC PIPE CUTTER

- Suitable for PVC, PP, PB, PEX.
- Ergonomic design with rubber grip on handle.
- Lightweight alloy body assures extra strength.
- Designed with minimum gap between handles to allow one hand operation.
- Easy to replace stainless steel blade.
- V-Shaped edge allows easy start for cutting.



ITEM NO.	DESCRIPTION
568-0200	1/4" – 1 5/8" Capacity
568-6300	2 1/2 Capacity
568-0224	Replacement Cutter Blade For 568-0200
568-6324	Replacement Cutter Blade For 568-6300

PIPE VISES

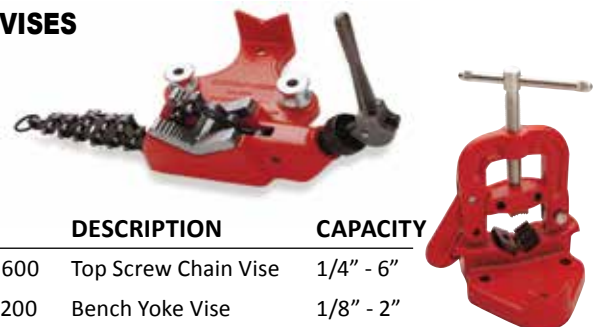

ITEM NO.	DESCRIPTION	CAPACITY
404-0600	Top Screw Chain Vise	1/4" - 6"
450-0200	Bench Yoke Vise	1/8" - 2"



HYDRAULIC PIPE BENDER - Made in Spain

- Capable of bending black iron and galvanized pipe in excess of 90°.
- Maximum ram power CVT-2=16.5 tons.
- Built-in safety valve prevents overloading.
- Supplied with, tripod stand, and selection of bending shoes.

ITEM NO.	DESCRIPTION
----------	-------------



DR2 Pipe Bender With Shoes For 1/2", 3/4", 1", 1 1/4", 1 1/2", 2" Pipe



ENCLOSED RATCHET THREADER KITS



ITEM NO.	DESCRIPTION
----------	-------------

600-2236 Enclosed Ratchet 4 Threader Heads - 1/2", 3/4", 1", 1 1/4" N.P.T. Molded ABS Case

600-2331 Enclosed Ratchet 7 Threader Heads - 3/8", 1/2", 3/4", 1", 1 1/4", 1 1/2", 2" NPT with Adaptor Molded ABS Case



* Custom Kits Available From Open Stock.

SERIES 600

ENCLOSED RATCHET THREADER REPLACEMENT DIES & DROP HEADS WITH DIES

DROP HEAD WITH DIES	REPLACEMENT DIES ONLY
---------------------	-----------------------

SIZE	ITEM NO.	ITEM NO.
1/4"	6002-N	6002-N40
3/8"	6003-N	6003-N40
1/2"	6004-N	6004-N40
3/4"	6005-N	6005-N40
1"	6006-N	6006-N40
1 1/4"	6007-N	6007-N40
1 1/2"	6008-N	6008-N40
2"	6009-N	6009-N40



RATCHET HANDLES AND ADAPTORS, for Series 600 Enclosed Ratchet



ITEM NO.	DESCRIPTION
----------	-------------

600-0000 1/4" - 1 1/4" Ratchet
 600-0100 1/4" - 2" Ratchet
 600-0115 Reduction Adaptor Used With 600-0100 Ratchet Suitable For 1/4" - 1 1/4"



HOOK JAWS (MOVING JAWS)

ITEM NO.	FITS	ITEM NO.	FITS
102-0802	8"	102-2402	24"
102-1002	10"	102-3602	36"
102-1202	12"	104-4802	48"
102-1402	14"	105-1402	14" #105-1400
102-1802	18"	105-1802	18" #105-1800

* Note: Series 102, 104, 112 Hook & Heel. Jaw & Nut are interchangeable with RIDGID™ Pipe Wrenches.



HEEL JAWS AND PINS

ITEM NO.	FITS	ITEM NO.	FITS
102-0815	8"	102-2415	24"
102-1015	10"	102-3615	36"
102-1215	12" & 14"	104-4815	48"
102-1815	18"		



DEBURRING SET - Made in Spain

- 3 1/4" overall length (includes 2-1/4" plastic handle).
- Full 360° rotation of deburring blade.
- Replacement blade available.

ITEM NO.	DESCRIPTION
750-0041	2 Pce. Deburring Set





KNURL NUTS



ITEM NO.	FITS	ITEM NO.	FITS
102-0804	8"	102-1804	18"
102-1004	10"	102-2404	24"
102-1204	12"	102-3604	36"
102-1404	14"	104-4804	48"



SPARE CUTTER WHEEL PINS



ITEM NO.	FITS	ITEM NO.	FITS
*701-0115	701-0100	*725-0006	725
*710-0215	701-0200	*735-0007	735, Old Style
*710-0415	710-0400	*735-0048	716, 722, 728, 735
*716-0014	716, 722, 726	*751-0007	750 (With Screw) Old Style
		*751-0042	750 New Style

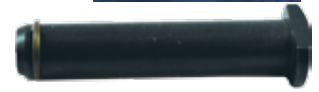

**FOB SURREY, BC ONLY*

SETS OF SPRINGS - Flat & Coil

ITEM NO.	FITS	ITEM NO.	FITS
102-0813	8"	102-1813	18"
102-1013	10"	102-2413	24"
102-1213	12"	102-3613	36"
102-1413	14"	104-4813	48"
105-1405	14" Offset		
105-1805	18" Offset		



SPARE ROLLERS FOR TUBING CUTTERS & PIPE CUTTERS

ITEM NO.	FITS	ITEM NO.	FITS
*701-0106	701-0100 - 1 1/4"	*750-0005	750 Large
*710-0206	701-0200 - 2"	*750-0006	750 Small
*710-0406	710-0400 - 4"	*751-0006	751
*735-0006	735		



**FOB SURREY, BC ONLY*

SPARE CUTTER WHEELS FOR TUBING CUTTERS

ITEM NO.	FITS
735-0005	716, 722, 726, 728, 735 & 750 for Copper
735-0015	716, 722, 725, 726, 728 & 735 for Stainless
763-0122	726, 735, 750 for Plastic
*737-0005	751, 752 for Copper
*737-0122	750, 751, 752 for Plastic



**FOB SURREY, BC ONLY*

SPARE ROLLER PINS FOR TUBING CUTTERS & PIPE CUTTERS

ITEM NO.	FITS	ITEM NO.	FITS
*701-0116	701-0100 - 1 1/4"	*735-0009	735
*710-0216	701-0200 - 2"	*750-0009	750
*710-0416	710-0400 - 4"	*751-0009	751
*725-0007	725		



**FOB SURREY, BC ONLY*

SPARE CUTTER WHEELS FOR PIPE CUTTERS FOR STEEL PIPE

ITEM NO.	FITS
701-0105	701 - 1 1/4"
710-0205	701 - 2"
710-0405	710 - 4"



SPARE DEBURRING BLADE FOR COPPER

ITEM NO.	FITS
735-0014	735 Tube Cutter



REPLACEMENT PARTS FOR CHAIN WRENCH & STRAP WRENCH

ITEM NO.	DESCRIPTION
*103-3213	Chain Only - Fits 103-3200
*103-3314	Chain Only - Fits 103-3300
*103-3414	Chain Only - Fits 103-3400
106-1211	Chain Only - Fits: 107-1200
108-02L4	8" Capacity Strap Only - Fits: 108-12L0



**FOB SURREY, BC ONLY*

REPLACEMENT PARTS FOR CHAIN VISE

ITEM NO.	DESCRIPTION
404-0620	Chain Only - Fits: 404-0600
404-0602	Jaws Only - Fits: 404-0600





CHANNELLOCK - Made in U.S.A.



ISO 9001

- All tongue and grooves are undercut to prevent slippage.
- All cutter jaws are perfectly mated and heat treated to hold their edge.

TONGUE AND GROOVE PLIERS

ITEM NO.	LENGTH	DESCRIPTION
----------	--------	-------------

CH-420	9 1/2"	5 Adjustments, 1 1/2" Cap
--------	--------	---------------------------



CH-422	9 1/2"	5 Adjustments, 1 1/2" Cap., Curved Jaw
--------	--------	--



CH-424	4 1/2"	3 Adjustments, 1/2" Cap
--------	--------	-------------------------



CH-426	6 1/2"	5 Adjustments, 7/8" Cap
--------	--------	-------------------------



CH-430	10"	7 Adjustments, 2" Cap
--------	-----	-----------------------



CH-440	12"	7 Adjustments, 2 1/4" Cap
--------	-----	---------------------------



CH-442	12"	7 Adjustments, 2 1/4" Cap., Curved Jaw
--------	-----	--



CH-460	16"	8 Adjustments, 4 1/4" Cap
--------	-----	---------------------------



CH-480	20 1/4"	12 Adjustments, 5 1/2" Cap
--------	---------	----------------------------



NUTBUSTER PLIERS



ITEM NO.	LENGTH	DESCRIPTION
----------	--------	-------------

CH-410	9 1/2"	4 Adjustments, 1 1/8" Cap
--------	--------	---------------------------



CH-414	14"	4 Adjustments, 2" Cap
--------	-----	-----------------------



LONG NOSE PLIERS

ITEM NO.	LENGTH	DESCRIPTION
----------	--------	-------------

CH-317	7 1/2"	Side Cutter
--------	--------	-------------

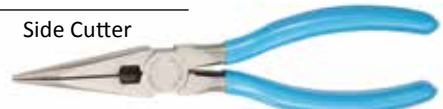

CH-326	6"	Side Cutter
--------	----	-------------

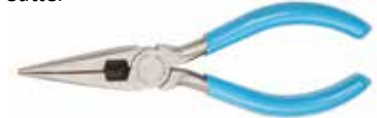

LINEMEN'S - ELECTRICIANS' PLIERS

ITEM NO.	LENGTH	DESCRIPTION
----------	--------	-------------

CH-350S	9"	Iron Worker's Pliers With Coiled Spring
---------	----	---



SLIP JOINT PLIERS

ITEM NO.	LENGTH	DESCRIPTION
----------	--------	-------------

CH-526	6"	With Wire Cutting Shear
--------	----	-------------------------





CUTTING PLIERS



ITEM NO.	LENGTH	DESCRIPTION
CH-337	7"	Lap Joint Diagonal
CH-338	8"	Lap Joint Diagonal
CH-436	6"	Box Joint Diagonal Pliers
CH-437	7"	Box Joint Diagonal
CH-447	7 3/4"	Lap Joint Curved Diagonal
CH-911	9 1/2"	Soft Cable Cutter

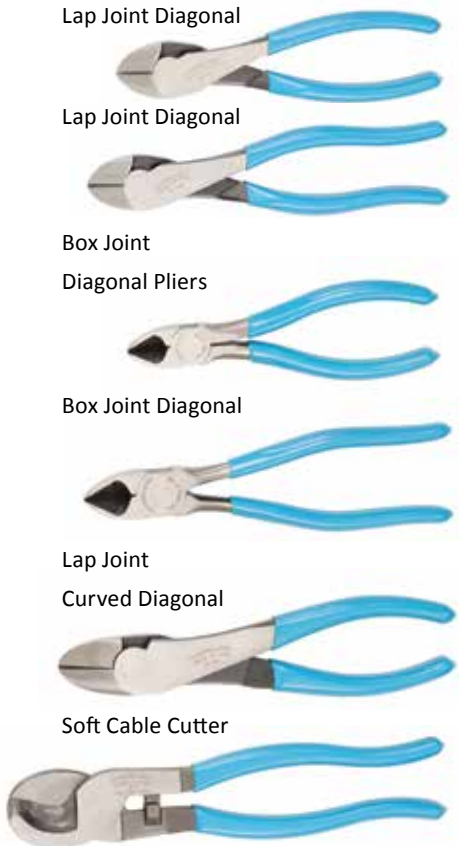

WELDERS PLIERS

- Made in USA.
- Grooved nose design for easier splatter removal.
- Grips and draws out wire.
- Spring loaded handles.
- Hammer face on each side.

ITEM NO.	LENGTH	DESCRIPTION
CH-360	9"	Welders Plier



END NIPPERS

ITEM NO.	LENGTH	DESCRIPTION
CH-357	7"	End Cutter
CH-358	8"	End Cutter



SNAP RING PLIERS



ITEM NO.	DESCRIPTION
CH-927	Internal/External Changeable Snap Ring Pliers
CH-927T	Replacement Tip Kit

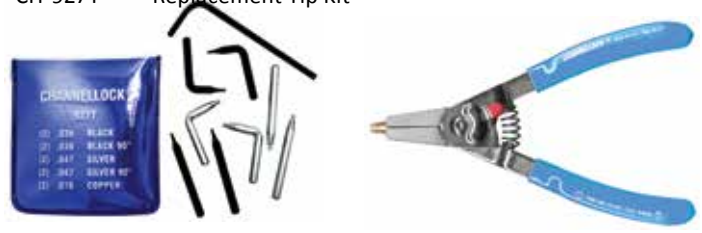

SNAP RING PLIER

ITEM NO.	DESCRIPTION
CH-929	Internal/External Changeable Snap Ring Pliers External 1 1/2" - 4" Internal 1 13/16" - 4" Supplied With 2 Each: .090, .108, .120 15° and .090, .108, .120 90° Tips
CH-929T	Replacement Tip Set for CH-929 Includes 2 Each: .090, .108, .120 15° and .090, .108, .120 90° Tips



WIRING TOOLS

- Long curved handles for easier cutting.
- Strips both solid and stranded wire.
- Air pocket grips for comfort.

ITEM NO.	LENGTH	DESCRIPTION
CH-908	8 1/4"	Wire Crimper, Cutter And Stripper

CH-909	8 1/4"	Crimping And Cutting Pliers
--------	--------	-----------------------------

CH-957	7"	Wire Stripping Tool Narrow Nose For Use On Nuts And Pulling Wire Locks For Storage Usable For 10-20 AWG
--------	----	---



WIRING TOOLS (Continued)



ITEM NO.	LENGTH	DESCRIPTION
----------	--------	-------------

CH-958	6"	Spring Loaded Wire Stripper
--------	----	-----------------------------



CH-959	8 1/2"	Wire Cutter, Crimper & Stripper. Crimps Both Insulated & Non-Insulated Terminals Usable For 8-22 AWG
--------	--------	--



RESCUE TOOLS

- Made in the USA.
- One hand usage, spring loaded handle.
- Designed to shut off gas valves, pry windows and doors, tighten & loosen up to 5" hose couplings.
- Laser heat treated cutting edges to cut hard and soft wire.



ITEM NO.	DESCRIPTION
----------	-------------

CH-86	9" Rescue Tool Multi-plier
-------	----------------------------

- Made in the USA.
- 30% Lighter than previous models.
- Fits in bunker pockets.
- Hardened cutting edge cuts through standard battery cables and soft metals.
- Narrow jaw fits tight spots.
- Spanner tightens, loosens up to 5" hose couplings.
- Pries open windows and doors,
- Shuts off gas safety valves.
- Overall length 8.88", weight 1.13 lbs.



ITEM NO.	DESCRIPTION
----------	-------------

CH-87	7" Rescue Tool
-------	----------------

OIL FILTER WRENCH

- 6 tongue and groove adjustments.
- 15" overall length.
- Jaw capacity 2 1/2" - 5 1/2".



ITEM NO.	DESCRIPTION
----------	-------------

CH-215	Heavy Duty Oil Filter/PVC Pipe Plier
--------	--------------------------------------

CRIMPING TOOL KIT

- Packed in plastic case.
- Each set contains: 9" Crimping tool for crimping, cutting and stripping wire; 6" insulated needle nose pliers; 1 slot and 1 Phillips screwdriver; 1 roll of PVC tape; assortment of 30 insulated terminals; 6-24 volt continuity tester.



ITEM NO.	WEIGHT
----------	--------

LY-8023	1 1/2 lbs.
---------	------------

SNAP RING PLIER SET

- Suitable for internal and external use.
- Supplied with 1mm 45°, 90°, 180° and 2mm 180° jaws.



ITEM NO.	DESCRIPTION
----------	-------------

PRP-5	Snap Ring Plier Set, Blister Carded
-------	-------------------------------------

PRP-5T	4 Pc. Tip Set - Carded
--------	------------------------

5 PCE. MINI PLIER SET

- Drop forged alloy steel.
- Insulated PVC grip.
- Spring loaded.
- Packaged in a vinyl roll.



ITEM NO.	INCLUDES
----------	----------

GH-5001	4 1/2" Long Nose 4 1/2" Diagonal Cutting 4 1/2" Flat Nose 4 1/2" End Cutting 4 1/2" Bent Nose
---------	---

FENCE PLIER

- Made of drop forged alloy steel.
- Polished head.
- PVC coated handles.
- Packed in plastic pouch.



ITEM NO.	DESCRIPTION
----------	-------------

FP-1000	10" Fence Pliers
---------	------------------

WIRE STRIPPER - Automatic

- Alloy steel jaw.
- Strips wire from 8-26 gauge.
- Cutters are hardened to HRC 40-50.
- PVC coated handle.
- Also crimps insulated terms 10-22AWG and 12-10, 22-18, 16-14AWG.
- Non-insulated terms and 7 - 8mm auto terminals.



ITEM NO.	DESCRIPTION
GD-163	Carded Automatic Wire Stripper

LOCKING GRIP PLIERS

- Chrome vanadium steel.
- Drop forged jaws.
- Heat treated & hardened.
- Nickel plated.
- Carded.



ITEM NO.	LENGTH	JAW TYPE
GM-507A	7"	Curved
GM-507RA	7"	Straight
GM-510A	10"	Curved
GM-510RA	10"	Straight
GM-6LNA	6"	Long Nose
GM-9LNA	9"	Long Nose

LOCKING CLAMP PLIER

- Wide 3 3/4" opening jaw.
- Nickel plated.
- Carded.



ITEM NO.	LENGTH	JAW TYPE
GM-311RA	11"	3 3/4" Clamp

PARALLEL ACTION SIDE CUTTING PLIERS - Made in England

- Sealed handles, knurled jaws.
- Parallel jaws provide a positive grip on square or hexagonal components.
- Compound action side cutter allows high tensile wire to be cut with little effort.
- Commonly used to cut bale wire in pulp mills.



ITEM NO.	DESCRIPTION
----------	-------------

*4950-200 8" Parallel Action Pliers With Cutter ***FOB SURREY, BC ONLY**

REVOLVING PUNCH PLIER Made in England

- Nickel-plated, knurled handles.
- 6 Punch sizes: 2.0, 2.5, 3.5, 3.9, 4.0, 4.5mm.
- Brass anvil.
- Used for leather, gaskets and other composite materials.
- Spring-loaded handles.
- Attractively carded.



ITEM NO.	DESCRIPTION
----------	-------------

2230-200 8" Revolving Punch

ADJUSTABLE WRENCHES

- Chrome plated heat-treated.
- Polished head.
- Jaw hardness up to HRC 45° - 50°.



ITEM NO.	OVERALL LENGTH	MAX OPENING
----------	----------------	-------------

Chrome Vanadium Steel:

91-06	6"	3/4"
91-08	8"	15/16"
91-10	10"	1 3/16"
91-12	12"	1 7/16"
91-15	15"	1 3/4"
91-18	18"	2 1/8"

Alloy Steel:

91-24	24"	2 3/8"
-------	-----	--------





COMBINATION WRENCH SETS 14 Piece – Raised Panel



- Raised panel long handle design.
- Chrome vanadium steel.
- Drop forged and hardened.
- Supplied in nylon-backed vinyl roll.
- Individually boxed.



ITEM NO.	DESCRIPTION
----------	-------------

CW-14S	Standard set contains one each: 3/8", 7/16" 1/2", 9/16", 5/8", 11/16" 3/4", 13/16", 7/8", 15/16", 1", 1 1/16" 1 1/8", 1 1/4"
CW-14M	Metric set contains one each: 8mm, 9mm, 10mm, 11mm, 12mm, 13mm, 14mm, 15mm, 17mm, 18mm, 19mm, 20mm, 22mm, 24mm

JUMBO COMBINATION WRENCH SETS 6 & 10 Piece Sets



- Chrome vanadium steel.
- Chrome and raised panel.
- Long handle design.



ITEM NO.	SIZES
----------	-------

CW-6J (6 pc. set)	1 3/8", 1 1/2", 1 5/8", 1 3/4", 1 7/8", 2" Supplied in plastic carry case
CW-10J (10 Pc. Set)	1 3/8", 1 5/16, 1 1/2", 1 7/16", 1 5/8", 1 11/16", 1 13/16", 1 3/4", 1 7/8", 2" Supplied in vinyl roll
CW-10JM (10 Pc. Set)	33mm, 34mm, 36mm, 38mm, 41mm, 42mm, 44mm, 46mm, 48mm, 50mm Supplied in vinyl roll

COMBINATION WRENCH SET 7 Piece Self Ratcheting



- Nickel chrome plated
- Raised panel
- Drop forged chrome vanadium
- Heat treated
- 5/16", 3/8", 7/16", 1/2", 9/16", 5/8",
11/16"
- Supplied with PVC carry case



ITEM NO.	DESCRIPTION
----------	-------------

CWR-7S	Combination Wrench Set Self Ratcheting
--------	---

FLARE NUT WRENCH SETS



- Available SAE or Metric
- Polished finish
- Chrome vanadium steel
- Drop forged
- Supplied in handy plastic rack with handle



ITEM NO.	DESCRIPTION
----------	-------------

FN-5M	5 Piece Flare Nut Wrench Set 6 x 8 mm, 10 x 12 mm, 13 x 14 mm, 15 x 17 mm, 19 x 22mm
FN-5S	5 Piece Flare Nut Wrench Set 1/4" x 5/16", 3/8" x 7/16", 1/2" x 9/16", 5/8" x 11/16", 3/4" x 13/16"

COMBINATION WRENCHES Open Stock - Sae And Metric



- Raised panel long handle design.
- Chrome vanadium steel.
- Drop forged and hardened.
- Chrome plated raised panel.
- Supplied with convenient hanger tag.

ITEM NO.	SIZE - SAE	ITEM NO.	SIZE METRIC
----------	------------	----------	-------------

CW-1-4	1/4"	CW-06MM	6mm
CW-5-16	5/16"	CW-07MM	7mm
CW-3-8	3/8"	CW-08MM	8mm
CW-7-16	7/16"	CW-09MM	9mm
CW-1-2	1/2"	CW-10MM	10mm
CW-9-16	9/16"	CW-11MM	11mm
CW-5-8	5/8"	CW-12MM	12mm
CW-11-16	11/16"	CW-13MM	13mm
CW-3-4	3/4"	CW-14MM	14mm
CW-13-16	13/16"	CW-15MM	15mm
CW-7-8	7/8"	CW-17MM	17mm
CW-15-16	15/16"	CW-18MM	18mm
CW-1	1"	CW-19MM	19mm
CW-1-1-16	1 1/16"	CW-20MM	20mm
CW-1-1-8	1 1/8"	CW-22MM	22mm
CW-1-1-4	1 1/4"	CW-24MM	24mm
		CW-26MM	26mm
		CW-27MM	27mm
		CW-30MM	30mm
		CW-32MM	32mm





JUMBO WRENCHES - Open Stock

- Chrome vanadium steel.
- Chrome plated raised panel.
- Long handle design.

ITEM NO.	SIZE - SAE	ITEM NO.	SIZE METRIC
CW-6J-1	1 3/8"	CW-6J-33MM	33mm
CW-6J-05	1 5/16"	CW-6J-34MM	34mm
CW-6J-2	1 1/2"	CW-6J-36MM	36mm
CW-6J-15	1 7/16"	CW-6J-38MM	38mm
CW-6J-3	1 5/8"	CW-6J-41MM	41mm
CW-6J-35	1 11/16"	CW-6J-42MM	42mm
CW-6J-4	1 3/4"	CW-6J-44MM	44mm
CW-6J-45	1 13/16"	CW-6J-46MM	46mm
CW-6J-5	1 7/8"	CW-6J-48MM	48mm
CW-6J-6	2"	CW-6J-50MM	50mm



HEX KEY SET

- 25 pce. metric and SAE.
- Chrome vanadium steel, black finish.
- Long arm SAE, sizes 1/16" - 3/8".
- Short arm metric, sizes 1.5mm - 10mm.
- Packed in vinyl roll.

ITEM NO.	DESCRIPTION
6010	Hex Key Set



HEX KEY SETS - T Handle

- 10 pcs. plus metal rack.
- ABS handles with size markings.
- Chrome vanadium steel.
- Overall length 129mm - 184mm.

ITEM NO.	DESCRIPTION
THX-10S	SAE includes: 3/32", 7/64", 1/8", 9/64", 5/32", 3/16", 7/32", 1/4", 5/16", 3/8"
THX-10M	Metric includes: 2mm, 2.5mm, 3mm, 4mm, 4.5mm, 5mm, 5.5mm, 6mm, 8mm, 10mm



**21 PC SAE SOCKET SET
7/8" TO 2" Sockets - 3/4" Drive**

- Carbon steel sockets, ratchet, and extensions.
- 12 point sockets, 7/8" to 2".
- Set includes - 16 sockets
- 20" ratchet handle
- 15" sliding "T" handle
- 4" & 8" extension bars
- packed in metal case with handle.



ITEM NO.	DESCRIPTION
CS-3421	3/4" Drive 21 Pc Socket Set

PIN PUNCH SET - 5 pce.

- Made from chrome vanadium ste
- Supplied in a strong vinyl pouch with cloth backing.
- 1/8", 5/32", 3/16", 1/4", 5/16" size
- Overall length 5 1/2" to 6".

ITEM NO.	DESCRIPTION
PPS-5	5 Pc Pin Punch Set



PUNCH & CHISEL SET

- 12 pcs. in a vinyl roll.
- High carbon steel, hardened & tempered.

ITEM NO.	INCLUDES
PC-12	4 - Flat Chisels - 1/2", 5/8", 3/4", 7/8" 2 - Taper Punches - 1/4", 3/16" 1 - Long Taper Punch - 3/16" 2 - Pin Punches - 1/4", 5/32" 1 - Center Punch - 3/8" 1 - Cape Chisel - 3/16" 1 - Concrete Chisel - 9/16"





WAD PUNCH KIT Made in England

- Includes wad punch handle and 9 interchangeable punches.
- Punches are heat treated and ground to a fine cutting edge.
- Packed in a sturdy ABS organizer box.
- Replacement handle and punches available.



PRECISION SCREW DRIVER SET - 6 Pieces

- Ideal for crafts, electronics and eye glasses.
- Plated steel handle with free-spinning end.
- Blister carded.

Kit contains 1 each: #1 Phillips, #0 Phillips, 1.4mm slot, 2.0mm slot, 2.4mm slot 3.0mm slot.

ITEM NO.	DESCRIPTION
PSS-6	Precision Screwdriver Set



ITEM NO.	PUNCH SIZES
1001-05	1/4", 5/16", 3/8", 7/16", 1/2", 5/8", 3/4", 7/8", 1"
1000-04	Spare Handle For The Above Set

6 IN 1 SCREWDRIVER ASSORTMENT

- Carded.
- Contains 1 each of:
 - 3/16" slotted bit
 - 1/4" slotted bit
 - #1 Phillips bit
 - #2 Phillips bit
 - #1 Robertson bit
 - #2 Robertson bit.

ITEM NO.	DESCRIPTION
P63-007	6 in 1 Screwdriver



REPLACEMENT PUNCHES

1000-006	1/4"
1000-008	5/16"
1001-375	3/8"
1000-016	5/8"
1001-438	7/16"
1000-125	1/2"
1001-750	3/4"
1001-875	7/8"
1000-025	1"

NUMBER AND LETTER STAMP SETS

- High carbon steel.
- Supplied in a plastic box.
- Dimension represents height of digit.

ITEM NO.	DESCRIPTION
NUM-1-8	1/8" Number Set, 9 Piece 1 - 0
NUM-3-16	3/16" Number Set 9 Piece 1 - 0
NUM-1-4	1/4" Number Set 9 Piece 1 - 0
LET-1-8	1/8" Letter Set 27 Piece A-Z Plus &
LET-3-16	3/16" Letter Set 27 Piece A-Z Plus &
LET-1-4	1/4" Letter Set 27 Piece A-Z Plus &



DRYWALL SCREW BIT

- For use with variable speed power drills.
- #2 Phillips bit fits most drywall screws.
- Sets screws at proper depth.

ITEM NO.	DESCRIPTION
DSA-1	Drywall Screw Bit - Carded



IMPACT SCREWDRIVER

- Reversible, can be used to tighten or loosen screws.
- Comes with 4 different bits (2 flat, 2 Phillips).
- Spare bits available.
- Chrome vanadium bits.

ITEM NO.	DESCRIPTION
2500	Impact Screwdriver
2501	#2 & #3 Spare Phillips Tip
2502	5/16" & 3/8" Spare Flat Tip



SCREWDRIVER SETS - Boxed

- Chrome vanadium steel.
- Magnetic tip.
- Hex shaped bolster for wrench assisted turning power.
- Comfort grip vinyl handle resistant to moisture, grease, oil and most solvents.
- Attractively packed in a plastic organizer tray.



ITEM NO.	CONTENTS
SD-S-08	8 pc. Set: - 5 Slotted Tip - 3 Phillips Tip
SD-S-11	11 pc. Set: - 5 Slotted Tip - 3 Phillips Tip - 3 Robertson Tip
SD-S-11TQ	11 pc. Set: - 5 Slotted Tip - 3 Phillips Tip - 3 Torque, T-10, T-15, T-20

SCREWDRIVERS - Open Stock

- Chrome vanadium steel.
- Hex shaped bolster for wrench assisted turning power.
- Classic black ABS plastic handle.
- Bulk.

ITEM NO.	TIP	SIZE
SD-S-001	Slot	3/8" x 8"
SD-S-002	Slot	5/16" x 6"
SD-S-003	Slot	1/4" x 4"
SD-S-004	Slot	3/16" x 3"
SD-S-005	Slot	1/4" x 1 1/2" Stubby
SD-S-006	Phillips	1/4" x 4"
SD-S-007	Phillips	3/16" x 3"
SD-S-008	Phillips	1/4" x 1 1/2" Stubby
SD-S-S1	Robertson	#1 x 4" Green Handle
SD-S-S2	Robertson	#2 x 4" Red Handle
SD-S-S3	Robertson	#3 x 4" Black Handle
SD-S-T10	Torque	T10 x 4"
SD-S-T15	Torque	T15 x 4"
SD-S-T20	Torque	T20 x 4"

RIVETS

- Dome head type.
- Poly bagged with header card or boxed.
- Coated steel mandrels.

ITEM NO.	DESC.	RIVET BODY SIZE	RIVET BODY LENGTH	RIVET MAT.	MANDREL MAT.	GRIPPING RANGE	DRILL SIZE	PKG.
42	Aluminum Steel Rivet	1/8" (3.2mm)	1/4"	Aluminum	Coated Steel	1/16"-1/8"	.129-.133 #30	Poly bag 100
43	Aluminum Steel Rivet	1/8" (3.2mm)	5/16"	Aluminum	Coated Steel	1/8"-3/16"	.129-.133 #30	Poly bag 100
44	Aluminum Steel Rivet	1/8" (3.2mm)	3/8"	Aluminum	Coated Steel	3/16"-1/4"	.129-.133 #30	Poly bag 100
46	Aluminum Steel Rivet	1/8" (3.2mm)	1/2"	Aluminum	Coated Steel	5/16"-3/8"	.129-.133 #30	Poly bag 100
42S	Steel/Steel Rivet	1/8" (3.2mm)	1/4"	Steel	Coated Steel	1/16"-1/8"	.129-.133 #30	Poly bag 100
43S	Steel/Steel Rivet	1/8" (3.2mm)	5/16"	Steel	Coated Steel	1/8"-3/16"	.129-.133 #30	Poly bag 100
44S	Steel/Steel Rivet	1/8" (3.2mm)	3/8"	Steel	Coated Steel	3/16"-1/4"	.129-.133 #30	Poly bag 100
46S	Steel/Steel Rivet	1/8" (3.2mm)	1/2"	Steel	Coated Steel	5/16"-3/8"	.129-.133 #30	Poly bag 100
42SB	Steel/Steel Rivet	1/8" (3.2mm)	1/4"	Steel	Coated Steel	1/16"-1/8"	.129-.133 #30	Boxed 500
43SB	Steel/Steel Rivet	1/8" (3.2mm)	5/16"	Steel	Coated Steel	1/8"-3/16"	.129-.133 #30	Boxed 500
44SB	Steel/Steel Rivet	1/8" (3.2mm)	3/8"	Steel	Coated Steel	3/16"-1/4"	.129-.133 #30	Boxed 500
46SB	Steel/Steel Rivet	1/8" (3.2mm)	1/2"	Steel	Coated Steel	5/16"-3/8"	.129-.133 #30	Boxed 500
62S	Steel/Steel Rivet	3/16" (4.8mm)	5/16"	Steel	Coated Steel	1/16"-1/8"	.192-.196 #11	Poly bag 100
64S	Steel/Steel Rivet	3/16" (4.8mm)	7/16"	Steel	Coated Steel	3/16"-1/4"	.192-.196 #11	Poly bag 100



LIMITED QUANTITIES
NO BACK ORDERS

CAULKING GUNS

- Smooth rod action.
- Extra long trigger leverage.
- Accepts all standard cartridges.



ITEM NO.	DESCRIPTION
----------	-------------

Requires trigger release to stop caulk flow:

SM-900	Half-Open Type Cap. 1/10 Gallon (9" Cartridge.) "Smooth Rod Type"
*SM-690	Half-Open Type Cap. 1/10 Gallon (9" Cartridge.) "Ratchet Type"

*FOB SURREY, BC ONLY

- Revolving barrel 1/4 gallon half open type caulk gun.
- Ladder hook type plunger handle.
- Heavy duty cast handle and mechanism.



ITEM NO.	DESCRIPTION
WT-215JBR	Revolving 1/4 Gallon Half-Open Smooth Rod Caulking Gun

- 1/4 gallon half open type caulk gun.
- Spout cutter included.
- No pinch finger guard.
- Open end cartridge holder can be used with wide nozzle.
- Puncture tool included.



ITEM NO.	DESCRIPTION
*WT-230JBH (#315)	1/4 Gallon Half Open Type Caulking Gun

*FOB SURREY, BC ONLY

ITEM NO.	DESCRIPTION
----------	-------------

Automatic pressure release stops caulk flow immediately:

SK-200	Frame Type (Dripless) Cap. 1/10 Gallon (9" Cartridge)
SK-800	Frame Type (Dripless) Cap. 1/4 Gallon (13" Cartridge)

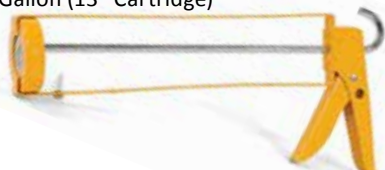

- 1/10 gallon (9" cartridge) skeleton type frame.
- Hex rod for positive grip.
- Cast handle.
- Riveted construction.
- Trigger release to relieve pressure.



ITEM NO.	DESCRIPTION
CG-800	1/10 Gallon Skeleton Type Caulking Gun

- Revolving parallel frame 1/10 gallon (9" cartridge).
- Heavy duty cast handle and smooth rod for smooth operation.
- Thumb release to release pressure.
- Open end cartridge holder can be used with wide nozzle.



ITEM NO.	DESCRIPTION
WT-215IH (#250)	1/10 Gallon Parallel Frame Caulking Gun Heavy Duty

- Parallel frame dual 1/10 gallon (9") cartridge caulk gun.
- Heavy duty cast handle and mechanism.
- Smooth rod mechanism.



ITEM NO.	DESCRIPTION
WT-296CT9	Dual 9" Cartridge Pro Caulking Gun

- 15" enclosed type w/smooth rod operation.
- Revolving Anodized aluminum body.
- Can be used with 600ml cartridge or can be filled.
- Supplied with plastic nozzle and plastic plunger for use when used without cartridge.

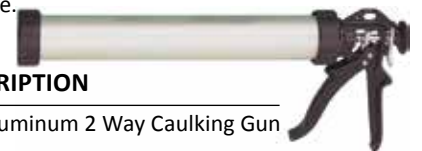

ITEM NO.	DESCRIPTION
WT-250XL	15" Aluminum 2 Way Caulking Gun
WT-250TN	Plastic Cone Nozzle For WT-2!
WT-250XL-07	Threaded Collar For WT-250X



ELECTRICIAN'S KNIFE
Made by Mora of Sweden



- Plastic handle with non slip rubber grip.
- Blade made of 12C27 Sandvik stainless steel.
- Blade is hardened to 57HRC for max sharpness and sharpness retention.
- Supplied with belt clip sheath.



ITEM NO.	DESCRIPTION
12201-BK	1 1/4" Blade Electricians Knife with Double Ground Stripping Blade Allows RH and LH
12798-BK	1 3/4" Blade Without Stripping Groove

UTILITY KNIVES - (Plastic Handle) And Blades

- Plastic handle with push button blade advance and safety lock.
- Individually sleeved.
- Snap-off blade design.

ITEM NO.	DESCRIPTION	REPLACEMENT BLADES
LC-499	Slim Design 5" X 5/8"	LCB-49
LC-500	Standard Design 6" X 1 1/4" X 3/4"	LCB-50
LC-501	Standard Design 6" X 1 1/4" X 3/4" With Metal Chamber For Extra Blades	LCB-50
LC-502	Heavy Duty Design 6 1/4" X 1 1/2" X 3/4" Automatic Locking Blade	LCB-50

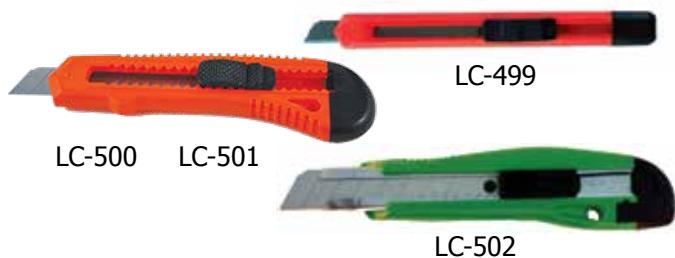

UTILITY KNIFE - (Plastic Handle) And Blades

- Snap-off blade design.
- Positive thumb-screw blade lock.
- Rubber insert on handle assures positive grip.
- Blister carded.



ITEM NO.	DESCRIPTION	REPLACEMENT BLADES
TH-2001BC	Standard Design 6 3/4" x 1 3/4 x 3/4"	LCB-50

UTILITY KNIFE - (Plastic Handle) And Blades

- Plastic handle with push button blade advance and auto lock.
- Snap off blade design.
- Metal reinforced blade guide.
- Non-slip rubber hand grip for
- Spare blade storage.
- Individually carded.



ITEM NO.	DESCRIPTION	REPLACEMENT BLADES
TH-2006BC	Heavy Duty Design 6 3/4" x 1 3/4 x 3/4"	LCB-50

UTILITY KNIFE - (Metal Handle) And Blades

- Alloy body with blade storage.
- 4 position blade advance.
- Carded.



ITEM NO.	DESCRIPTION	REPLACEMENT BLADES
UK-500	6" Overall Length	UKB-50

SCRAPER - (Razor Type) And Blades

- Plastic construction.
- Uses single edge blades.

ITEM NO.	DESCRIPTION	REPLACEMENT BLADES
LC-208	Plastic Scraper	LCB-50





REPLACEMENT BLADES

ITEM NO.	DESCRIPTION
LCB-49	Replacement Blades 12 Blades Per Tube To Fit: LC-498 And LC-499
LCB-50	Replacement Blades 12 Blades Per Tube To Fit: LC-500, LC-501, LC-502,
LCB-208	Replacement Blades 12 Per Tube To Fit: LC-208
UKB-50	Replacement Blades 12 Per Tube To Fit: UK-500 & BF011316BK

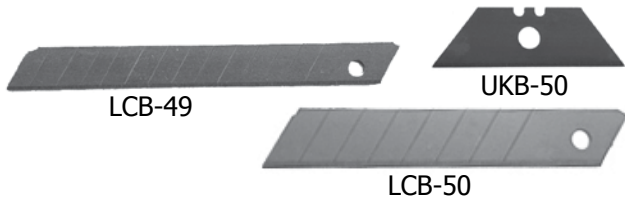

UTILITY KNIFE BLADE Replacement "Hook" Type

- Fits all standard size utility knives.
- Can be used to cut flooring or strapping.
- 10 blades per tube.

ITEM NO.	DESCRIPTION
*SK5-10	Replacement Hook Blade



***FOB DARTMOUTH, NS ONLY**

TELESCOPIC INSPECTION MIRROR AND MAGNETIC PICK UP TOOL

- Telescopic handle from 7" to 13" (16 1/2" extended overall length).
- One multi angle ball joint.
- Plated parts to prevent rusting.
- PVC coated handles for comfort.



ITEM NO.	DESCRIPTION
407-IM	Carded 2" Rounded Glass Telescopic Inspection Mirror
406-PT	Carded Telescopic Magnetic Pick Up Tool (Approx. 12 Oz. Capacity Lift)

MAGNETIC RETRIEVER



- Zinc plated and pvc coated to prevent rust.
- 80 lbs. static pull strength.
- Ideal for retrieving items dropped into water or other restricted areas.
- Clamshell packed.

ITEM NO.	DESCRIPTION
QJ8035	Magnetic Retriever



MAGNETS - Rare Earth



- 2" x 1/8" Neodymium (N35) alloy.
- Strong 10 lbs. holding capacity.
- Used to fasten items in industry and many other applications.
- Packed 2 magnets per blister card.

ITEM NO.	DESCRIPTION
QJ7248	2" x 1/8" Rare Earth Magnets



MAGNETIC SWEEPER Roller Type



- Quick release drops picked up items in one pull.
- Supplied with 1 1/2" x 6" rubber tread wheels.
- Extendable handle from 31 1/2" to 44 1/2".
- Ideal for parking lots and construction sites.
- Pull force 35 lbs.
- With hanger hole and boxed.

ITEM NO.	DESCRIPTION
QJ8012-24	24" Magnetic Sweeper



MAGNETIC TRAY Round Parts Dish



- Red powder coat paint to reduce glare.
- 6" x 1" round metal dish.
- PVC covered magnet prevents scratches.
- Very strong 6 lbs. holding power.
- Blister pack.

ITEM NO.	DESCRIPTION
QJ7004	Red Round Magnetic Tray





MAGNETIC TRAY
Rectangular Parts Tray



- Stainless steel to resist corrosion.
- 9 1/2" x 5 1/2" x 1" rectangular tray.
- PVC covered magnets to prevent scratches.
- Double 3 1/2" magnets provided.
- Approximately 10 lbs holding power.
- Blister carded.

ITEM NO.	DESCRIPTION
----------	-------------

QJ7006A Stainless Rectangular Magnetic Tray



MAGNETIC SOCKET TRAY



- Holds up to 1" diameter sockets.
- red powder coat finish.
- Tray dimensions: 11" x 3 1/2" x 1 1/8".
- Rubber coated magnets on back to prevent scratches.
- Magnetic strip on bottom of tray holds sockets in place.
- Box Pack.

ITEM NO.	DESCRIPTION
----------	-------------

QJ7020 Magnetic Socket Tray



MAGNETIC TOOL TRAY SET



- Set contains one each: 6" x 4 1/2" x 1 1/4" (1.3 lbs. capacity).
- 8" x 4 1/2" x 1 1/4" (1.7 lbs. capacity).
- 10 1/2" x 4 1/2" x 1 1/4" (2.2 lbs. capacity).
- 12 1/8" x 4 1/2" x 1 1/4" (2.6 lbs. capacity).
- Red powder coat paint.
- Magnets are rubber coated to prevent scratches.
- Box pack.

ITEM NO.	DESCRIPTION
----------	-------------

QJ7012 Magnetic Tool Tray Set



40 PC. TAP AND DIE SET
Tungsten Steel SAE



- Round dies.
- High quality tungsten steel, heat treated and tempered for Rockwell hardness 58° - 61° "C" scale.
- Combination NC, NF and pipe thread.
- One tap and one die of the following sizes:

NOM. SIZE	T.P.I.	NOM. SIZE	T.P.I.
4	- 40	5/16	- 18
6	- 32	5/16	- 24
8	- 32	3/8	- 16
10	- 32	3/8	- 24
10	- 24	7/16	- 14
12	- 24	7/16	- 20
1/4	- 20	1/2	- 13
1/4	- 28	1/2	- 20 1/8" NPT tap & die



- Also contains: 1 long handle adjustable tap wrench, 1 "T" handle, 1 die handle, 1 screwdriver, 1 screw pitch gauge, 1 handy molded carry case.

ITEM NO.	DESCRIPTION
----------	-------------

TD-40 SAE 40 Pc. Tap And Die Set

40 PC. TAP AND DIE SET
Tungsten Steel Metric



- Same as TD40 but with the following metric sizes for each tap and die:

NOM. SIZE	T.P.MM.	NOM. SIZE	T.P.MM.
3	- 0.5mm	7	- 1.0mm
3	- 0.6mm	8	- 1.0mm
4	- 0.7mm	8	- 1.25mm
4	- 0.75mm	10	- 1.25mm
5	- 0.8mm	10	- 1.5mm
5	- 0.9mm	12	- 1.5mm
6	- 0.75mm	12	- 1.75mm
6	- 1.0mm	1/8"	- NPT tap & die
7	- 0.75mm		



- Also contains: 1 long handle adjustable tap wrench, 1 "T" handle, 1 die handle, 1 screwdriver, 1 screw pitch gauge, 1 die handle, 1 screwdriver, 1 screw pitch gauge, 1 handy molded carry case.

ITEM NO.	DESCRIPTION
----------	-------------

TD-40M Metric 40 Pc. Tap And Die Set



41 PC. TAP & DIE SET - SAE - Made in Japan by SKC

- Round dies.
- High quality tungsten steel, heat treated and tempered for Rockwell hardness 58° - 61° C scale.
- Combination NC, NF and pipe thread.
- One tap and one die of the following sizes:

NOM. SIZE	T.P.I.	NOM. SIZE	T.P.I.
4	- 40	5/16	- 18
6	- 32	5/16	- 24
8	- 32	3/8	- 16
10	- 32	3/8	- 24
10	- 24	7/16	- 20
12	- 24	7/16	- 14
1/4	- 20	1/2	- 20
1/4	- 28	1/2	- 13
		1/8	- Pipe Thread



- Also contains; 2 tap wrenches, 1 long handle tap wrench, 1 die handle, 1 screwdriver & 1 screw pitch gauge.
- Packed in sturdy, molded, plastic case.

ITEM NO.	DESCRIPTION
850R	SAE 41 Pc. Tap And Die Set

45 PC. TAP & DIE SET - SAE Made in Japan by SKC

- Round dies.
- Tungsten steel heat treated & tempered to RHC 58° - 61°.
- Set designed with sizes that are most commonly used.
- Contains 2 tap wrenches, 2 die wrenches and 1 screwdriver.
- Packaged in metal case with ABS plastic tray.
- Combination NF and NC.
- One tap and one die of the following sizes:

NOM. SIZE	T.P.I.	NOM. SIZE	T.P.I.
1/4	- 28	1/4	- 20
5/16	- 24	5/16	- 18
3/8	- 24	3/8	- 16
7/16	- 20	7/16	- 14
1/2	- 20	1/2	- 13
9/16	- 18	9/16	- 12
5/8	- 18	5/8	- 11
3/4	- 16	3/4	- 10
7/8	- 14	7/8	- 9
1	- 14	1	- 8



ITEM NO.	DESCRIPTION
895	SAE 45 Pc. Tap And Die Set

41 PC. TAP & DIE SET - METRIC Made in Japan by SKC

- Same as 850R but with the following metric sizes for each tap & die:



NOM. SIZE	T.P.MM.	NOM. SIZE	T.P.MM.
3	- 0.6	3	- 0.5
4	- 0.75	4	- 0.7
5	- 0.9	5	- 0.8
6	- 1.0	6	- 0.75
7	- 1.0	7	- 0.75
8	- 1.25	8	- 1.0
10	- 1.5	10	- 1.25
12	- 1.75	1/8	- Pipe Thread

ITEM NO.	DESCRIPTION
851M	Metric 41 Pc. Tap And Die Set

110 PC. TAP & DIE SET - METRIC & SAE Made in Japan by SKC

- Round dies.
- High quality tungsten steel, heat treated and tempered to RHC 58° - 61°.
- 3 different tap wrenches & 2 die wrenches.
- Packed in metal case with handle.
- Combination of NC and NF, and metric course and fine.
- Contains one taper tap, one bottoming tap, and one die of the following sizes:

NOM. SIZE	T.P.I.	NOM. SIZE	T.P.I.	NPT & METRIC	T.P.MM.
4NC	40	3/8" NC	16	1/8" NPT	27
6NC	32	3/8" NF	24	1/4" NPT	18
8NC	32	7/16" NC	14	M6	1.0
10NC	24	7/16" NF	20	M8	1.25
12NC	24	1/2" NC	13	M10	1.5
10NF	32	1/2" NF	20	M10	1.0
1/4" NC	20	9/16" NC	12	M11	1.5
1/4" NF	28	9/16" NF	18	M12	1.25
1/4" NS	24	5/8" NC	11	M12	1.75
1/4" NS	18	5/8" NF	18	M14	1.25
5/16" NC	18	3/4" NC	10	M18	1.5
5/16" NF	24	3/4" NF	16		

ITEM NO.	DESCRIPTION
110-CFM	SAE & Metric 110 Pc Tap And Die Set





SCREW EXTRACTOR SETS - by SKC
Made in Japan

- High carbon steel.
- 5 pcs. in plastic case:

- #1 - for 1/8" - 1/4" screw.
- #2 - for 1/4" - 5/16" screw.
- #3 - for 5/16" - 7/16" screw.
- #4 - for 7/16" - 9/16" screw.
- #5 - for 9/16" - 3/4" screw.



ITEM NO.	DESCRIPTION
1815	Spiral Flute
1815-SQ	Square Flute

TWIST DRILL SETS

- High speed steel.
- Tin coated.
- Metal Index.



ITEM NO.	DESCRIPTION
D-210	21 Pc. Drill Set: 1/16" To 3/8" X 1/64" "Straight Shank"

LIMITED QUANTITIES - NO BACK ORDERS

D-290	29 Pc. Drill Set: 1/16" To 1/2" X 1/64" "Straight Shank"
-------	---

TWIST DRILLS

- High speed steel.
- Jobber length.
- Straight shank.
- Fine heat treated cutting edge.
- Excellent cutting performance and high durability.
- **Minimum order 10 drills per size.**



ITEM NO.	SIZE	ITEM NO.	SIZE
800-01	1/16"	800-15	9/32"
800-02	5/64"	800-16	19/64"
800-03	3/32"	800-17	5/16"
800-04	7/64"	800-18	21/64"
800-05	1/8"	800-19	11/32"
800-06	9/64"	800-20	23/64"
800-07	5/32"	800-21	3/8"
800-08	11/64"	800-22	25/64"
800-09	3/16"	800-23	13/32"
800-10	13/64"	800-24	27/64"
800-11	7/32"	800-25	7/16"
800-12	15/64"	800-26	29/64"
800-13	1/4"	800-27	15/32"
800-14	17/64"	800-28	31/64"
		800-29	1/2"

SILVER & DEMING (PRENTICE) DRILLS - 1/2" SHANK

- High speed steel.
- Jobber length.

ITEM NO.	SIZE	ITEM NO.	SIZE
950	17/32"	958	25/32"
951	9/16"	959	13/16"
952	19/32"	960	27/32"
953	5/8"	961	7/8"
954	21/32"	962	29/32"
955	11/16"	963	15/16"
956	23/32"	964	31/32"
957	3/4"	965	1"



SILVER & DEMING (PRENTICE) 5 PC. DRILL SET

- High speed steel.
- 6" Overall length.
- Set includes 9/16", 5/8", 3/4", 7/8", 1".
- Packed in wooden box.



ITEM NO.	DESCRIPTION
PD-5	5 Pc. Prentice Drill Set

STUB DRILL - Double End

- Packed in 10's.
- High speed steel, nitrate finish.

ITEM NO.	DESCRIPTION
804-125	1/8" x 2"



FILE HANDLES

- Durable plastic handles to fit chain saw files and most tanged files.

ITEM NO.	TANG SIZE	LENGTH
908-S	Small	4" - 102mm
908-M	Medium	4" - 102mm
908-XL	X-Large	4" - 102mm

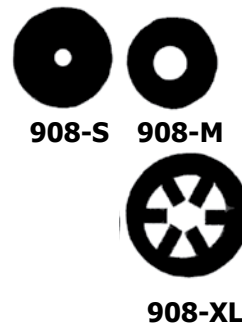

LIMITED QUANTITIES - NO BACK ORDERS



FILES - By JK Files

- Smooth cut used for a more finished or polished effect.
- Bastard cut used where aggressive removal of material is required.
- Measurement of a file is from end on file to shoulder not including tang.

FLAT FILES - Boxed

- Machinist's file tapered sides 2 cut edges.



ITEM NO.	LENGTH	SHAPE	CUT	BOX PACK
100-01	8"	Flat	Bastard	12
100-02	10"	Flat	Bastard	12
100-03	12"	Flat	Bastard	6
100-05	8"	Flat	Smooth	12
100-06	10"	Flat	Smooth	6

HALF ROUND FILES - Boxed

- Machinist's file.



ITEM NO.	LENGTH	SHAPE	CUT	BOX PACK
100-08	8"	Half Round	Bastard	12
100-09	10"	Half Round	Bastard	12
100-10	12"	Half Round	Bastard	6

ROUND FILES - Boxed

- Machinist's file.



ITEM NO.	LENGTH	SHAPE	CUT	BOX PACK
100-12	8"	Round	Bastard	12
100-13	10"	Round	Bastard	12

TRIANGULAR FILES - Boxed

- Machinist's file.



ITEM NO.	LENGTH	SHAPE	CUT	BOX PACK
100-15	6"	Triangular	Smooth	12

SAW FILES - Boxed

- Mill saw file parallel sided 2 cut edges.



ITEM NO.	LENGTH	SHAPE	CUT	BOX PACK
100-17	6"	Flat	Bastard	12
100-18	8"	Flat	Bastard	12
100-19	10"	Flat	Bastard	12
100-20	12"	Flat	Bastard	6

FILES - Handi File

- 8" File with handle 11 1/2" overall.
- 1 side single, 1 side double cut, 1 edge cut, 1 edge uncut.
- Rectangle shape.



ITEM NO.	LENGTH	SHAPE	CUT	BOX PACK
100-21	8"	Flat	Single Double	12

MOWER FILES - Boxed

- Mower (axe) file parallel sided 2 cut edges.

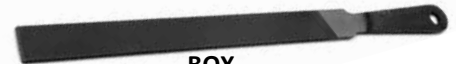

ITEM NO.	LENGTH	SHAPE	CUT	BOX PACK
100-22	8"	Flat	Second	12

FARMERS OWN (AXE) FILES - Boxed

- File with uncut edges.



ITEM NO.	LENGTH	SHAPE	CUT	BOX PACK
100-23	8"	Flat	Second	12

CHAINSAW FILES - Boxed

- Chain saw files.



ITEM NO.	LENGTH	DIA.	SHAPE	CUT	BOX PACK
100-24	6"	1/8"	Round	Double	12
100-25	8"	5/32"	Round	Double	12
100-26	8"	11/64"	Round	Double	12
100-27	8"	3/16"	Round	Double	12
100-28	8"	13/64"	Round	Double	12
100-29	8"	7/32"	Round	Double	12
100-30	8"	1/4"	Round	Double	12



FLAT CHAINSAW FILES - Boxed

- Files are 6" cut area.
- Chain saw file rounded uncut edges.



ITEM NO.	OVERALL LENGTH	SHAPE	EDGES	BOX PACK
100-32	8" Reg Duty	Flat	Rounded	12
100-33	8" Heavy Duty	Flat	Rounded	12

HORSE SHOE RASPS - Tanged

- 17" overall length including tang.
- Both edges cut.



ITEM NO.	DESCRIPTION
100-40	Horse Rasp

SHOE RASPS

- Two-cut edges.
- 6 Per box.



ITEM NO.	DESCRIPTION
100-41	14" Multi-Cut Shoe Rasp

WIRE WHEEL BRUSH SETS

- Brass coated crimped steel wire.
- 1/4" drill arbor, to be used with all hand drills.
- Used for removal of rust, paint or dirt build-up.
- Attractively blister carded.

ITEM NO.	DESCRIPTION
WW-03	Consists Of One Each: 2" Wheel, 2" Cup and 1" End Brush
WW-05	Consists Of One Each: 2" & 3" Wheel, 2" & 3" Cup and 1" End Brush



WW-03



WW-05

WIRE WHEEL BRUSHES - Display Box

- Includes 24 pieces with 1/4" shank.
- 6 each 2" plus 3" cup brushes and 6 each 1 1/2" plus 3" wire wheel brushes.
- All brushes are brass coated steel wire.



ITEM NO.	DESCRIPTION
WW-24	24 Piece Wire Brush Assortment

SANDING PAD

- Dual action random orbital operation
- Maximum operating speed 10,000 rpm



ITEM NO.	DESCRIPTION
----------	-------------

*VSP-6 6" Diameter With 5/16" X 24 Threaded

***FOB DARTMOUTH, NS ONLY**

ABRASIVE SANDING DISCS

- Resin fibre.

ITEM NO.	GRIT	DESCRIPTION
*6804-24	24	4" x 5/8"
*6845-24	24	4" 1/2" x 7/8"
*6807-24	24	7" x 7/8"
*6804-50	50	4" x 5/8"
*6845-50	50	4" 1/2" x 7/8"
*6805-50	50	5" x 7/8"



***FOB DARTMOUTH, NS ONLY**

CIRCULAR SAW BLADES

- Carbide tip.
- Individual cello wrapped in bulk box.
- Plastic tooth protector on each blade.



ITEM NO.	BLADE DIA.	BLADE THICKNESS	NO. TEETH	ARBOR SIZE	MAX. MAT. RPM
TCT725-24	7 1/4"	1.5mm	24T	5/8"	8000
TCT725-40	7 1/4"	1.5mm	40T	5/8"	8000
TCT725-60	7 1/4"	1.5mm	60T	5/8"	8000
TCT800-24	8"	1.5mm	24T	5/8"	7000
TCT825-24	8 1/4"	1.5mm	24T	5/8"	7000
TCT825-40	8 1/4"	1.5mm	40T	5/8"	7000
TCT1000-28	10"	1.8mm	28T	5/8"	5000
TCT1000-40	10"	1.8mm	40T	5/8"	5000
TCT1000-60	10"	1.8mm	60T	5/8"	5000
TCT1000-80	10"	1.8mm	80T	5/8"	5000
TCT1200-80	12"	1.8mm	80T	1"	6500



WIRE WHEEL BRUSHES - Display Box

- Includes 24 pieces with 1/4" shank.
- 6 each 2" plus 3" cup brushes and 6 each 1 1/2" plus 3" wire wheel brushes.
- All brushes are brass coated steel wire.

ITEM NO.	DIA.	ARBOR THREAD SIZE	FACE WTH.	WIRE SIZE	WIRE TYPE	TRIM LTH.	MAX. RPM.
KW100-5811	4"	5/8" x 11NC	1/2"	0.020"	Tempered	3/4"	11,000
KW125-5811	5"	5/8" x 11NC	9/16"	0.020"	Tempered	1 1/8"	10,000
KW150-5811	6"	5/8" x 11NC	9/16"	0.020"	Tempered	1 7/16"	9,000



CUP BRUSHES - Crimped Wire Type

- For angle grinders.
- For light or medium rust removal and deburring.
- Crimped brushes are less aggressive offering more flexibility.
- Blister carded.

ITEM NO.	DIA.	THREAD SIZE	WIRE SIZE	WIRE TYPE	LIST TRIM LENGTH	LIST MAX. RPM
CC075-10125	3"	M10 x 1.25	0.012"	Brass Coated Steel	1-1/6"	12,500
CC075-10150	3"	M10 x 1.50	0.012"	Brass Coated Steel	1-1/16"	12,500
CC075-14200	3"	M14 x 2.00	0.012"	Brass Coated Steel	1-1/16"	12,500
CC075-5811	3"	5/8" x 11NC	0.012"	Brass Coated Steel	1-1/16"	12,500
CC100-5811	4"	5/8" x 11NC	0.012"	Brass Coated Steel	1-1/8"	8,500
CC125-5811	5"	5/8" x 11NC	0.012"	Brass Coated Steel	1-5/16"	6,500
CC150-5811	6"	5/8" x 11NC	0.012"	Brass Coated Steel	1-5/16"	4,500



CUP BRUSHES - Knotted Wire Type

- For angle grinders.
- For heavy duty cleaning and resurfacing.
- More aggressive to remove rust, scale and other contaminants.
- Blister carded.

ITEM NO.	DIA.	BANDED	ARBOR THREAD SIZE	WIRE SIZE	WIRE TYPE	TRIM LTH.	MAX RPM.
KC065-10125	2 1/2"	NO	M10 x 1.25	0.020"	Tempered Steel	3/4"	12,500
KC065-10150	2 1/2"	NO	M10 x 1.50	0.020"	Tempered Steel	3/4"	12,500
KC065-14200	2 1/2"	NO	M14 x 2.00	0.020"	Tempered Steel	3/4"	12,500
KC080-14200	3 1/2"	YES	M14 x 2.00	0.020"	Tempered Steel	1"	8,500
KC065-5811	2 1/2"	NO	5/8" x 11NC	0.020"	Tempered Steel	3/4"	12,500
KC080-5811	3 1/2"	YES	5/8" x 11NC	0.020"	Tempered Steel	1"	8,500
KC100-5811	4"	YES	5/8" x 11NC	0.020"	Tempered Steel	1"	8,500
KC125-5811	5"	YES	5/8" x 11NC	0.020"	Tempered Steel	1"	6,500



WIRE WHEEL BRUSHES - Crimped Wire Type

- For bench grinders.
- Medium to heavy duty brush applications.
- Supplied with plastic adaptors to convert arbor hole size to 1/2", 5/8", 3/4", 7/8", 1".
- Blister carded.

ITEM NO.	DIA.	ARBOR THREAD SIZE	FACE WTH.	WIRE SIZE	WIRE TYPE	TRIM LTH.	MAX. RPM.
CW150-18	6"	1/2" - 1 1/4"	3/4"	0.012"	Brass Coated Steel	1 1/8"	6,000
CW150-25	6"	1/2" - 1 1/4"	1"	0.012"	Brass Coated Steel	1 1/8"	6,000
CW200-20	8"	1/2" - 1 1/4"	13/16"	0.012"	Brass Coated Steel	1 5/16"	4,500
CW200-25	8"	1/2" - 1 1/4"	1"	0.012"	Brass Coated Steel	1 5/16"	3,000



TAPERED BRUSHES - Crimped Wire Type

- For angle grinders.
- Best for medium to heavy duty work in corners and angles.

ITEM NO.	DIA.	ARBOR THREAD SIZE	FACE WTH.	WIRE SIZE	WIRE TYPE	TRIM LTH.	MAX RPM.
TCW10-5811	4"	5/8" x 11NC	3/8"	0.012"	Brass Coated Steel	13/16"	12,500
TCW20-5811	4"	5/8" x 11NC	13/16"	0.012"	Brass Coated Steel	13/16"	12,500



TAPERED BRUSH - Knotted Wire Type

- For angle grinders.
- For heavy duty work in corners and angles.

ITEM NO.	DIA.	ARBOR THREAD SIZE	FACE WTH.	WIRE SIZE	WIRE TYPE	TRIM LTH.	MAX. RPM.
TKW-5811	4"	5/8" x 11NC	1/2"	0.020"	Tempered Steel	7/8"	12,000



FLAP DISKS

- Blue Zirconia long lasting abrasive, Swiss cloth.
- Mounted on convex design depressed centre base plate.
- Usable for steel, aluminum, stainless steel.
- Recommended for angle grinders.

ITEM NO.	DIA.	HOLE SIZE	GRIT	TYPE
2824-45040	4 1/2"	7/8"	40	29
2824-45060	4 1/2"	7/8"	60	29
2824-45080	4 1/2"	7/8"	80	29
2824-45120	4 1/2"	7/8"	120	29
2824-50040	5"	7/8"	40	29
2824-50060	5"	7/8"	60	29
2824-50080	5"	7/8"	80	29
2824-50120	5"	7/8"	120	29





CUT-OFF WHEELS - Depressed Centre

- White aluminum oxide abrasive with resinoid bond.
- Used for cutting steel and stainless steel.
- Re-enforced to handle extra stress.
- WA36SBF Specification.

ITEM NO.	DIA.	THICKNESS	ARBOR	GRIT	USE	MAX. RPM
14056458	4"	3/32"	5/8"	36	Steel/SS	15,000
14556478	4 1/2"	3/32"	7/8"	36	Steel/SS	13,300
15056478	5"	3/32"	7/8"	36	Steel/SS	12,200



CUT-OFF WHEELS - Flat

- White aluminum oxide abrasive with resinoid bond.
- Used for cutting steel and stainless steel.
- Re-enforced to handle extra stress.
- T41 WA60SBF specification.

ITEM NO.	DIA.	THICKNESS	ARBOR	GRIT	USE	MAX. RPM
34036458	4"	3/64"	5/8"	60	Steel/SS	15,000
34536478	4 1/2"	3/64"	7/8"	60	Steel/SS	13,300
35036478	5"	3/64"	7/8"	60	Steel/SS	12,200



SAW - FOLDING CAMP/PRUNING SAW Made in Sweden



- 8" Overall blade length
- Plastic handle with rubber grips
- Large threaded knob for locking & unlocking blade position
- Positive lock in folded and unfolded position
- Lanyard provided for easy hanging
- Easy blade replacement
- Ideal for camping or backpacking
- Aggressive teething for fast clear cutting
- Can be used with most recip blades with universal shank
- Carded



ITEM NO.	DESCRIPTION
138-34	Folding Saw
1034-2006	Blade for 138-24



BOW SAWS - Made in Europe



- Oval, high frequency welded tube construction.
- Supplied with 3/4" hard point long-lasting raker tooth blade made from Swedish Steel.
- Painted with orange stove enamel to prevent rusting.



ITEM NO.	LENGTH	DESCRIPTION
14730SH21 (Previously 40021)	21"	Bow Saw
14030BH24 (Previously 40024)	24"	Bow Saw
14030BH30 (Previously 40030)	30"	Bow Saw
14030BH36 (Previously 40036)	36"	Bow Saw

REPLACEMENT BLADES



- 3/4" raker tooth bow saw blades made from Swedish Steel.
- Induction hardened to provide long lasting sharpness.



ITEM NO.	LENGTH	DESCRIPTION
G30SH21 (Previously 41021)	21" x 3/4"	Replacement Blade
G30BH24 (Previously 41024)	24" x 3/4"	Replacement Blade
G30BH30 (Previously 41030)	30" x 3/4"	Replacement Blade
G30BH36 (Previously 41036)	36" x 3/4"	Replacement Blade
G30BH42 (Previously 41042)	42" x 3/4"	Replacement Blade

12" HACKSAW/BOWSAW Made in Europe



- Combination saw for wood and metal
- Supplied with wood blade and 24T bi-metal hacksaw blade
- Blades can be adjusted at any angle to allow cutting in tight spaces

ITEM NO.	DESCRIPTION
G-12	12" Combination Hacksaw/Bowsaw
G10H12	Replacement Blade



HACKSAW FRAME
Made in Europe



- Compact frame fits in any toolbox.
- 16 x 10 mm rectangular steel frame with aluminum handle.
- 90° Blade mounting option.
- Includes 24T bi-metal blade.



ITEM NO.	DESCRIPTION
10BI24	12" Adjustable Hacksaw

MEAT SAW BLADE



- Stainless steel.
- Hardened teeth.
- Fits any 21" Bow Saw.



ITEM NO.	DESCRIPTION
G-5021	21" Stainless Steel Meat Saw

HACKSAW FRAME - Economy

- Tubular oval steel frame construction blade included.



ITEM NO.	DESCRIPTION
614	Adjustable 10"-12"

HANSAWS - Made in Sweden



- Blades made from Swedish steel.
- Universal tothing (U7) for both cross-cutting and rip-cutting
- Handle made from strong, long lasting ABS.
- Each blade protected by vinyl blade guard.
- Durable, long lasting electronically hardened teeth.

ITEM NO.	DESCRIPTION
G-319H	22" X 8 TPI Handsaw With Teflon Coated Blade To Reduce Friction
G-325H	22" X 8 TPI Handsaw With 45° - 90° Angles Indicated On Handle



MEAT SAW

- HD plated rectangular frame.
- 4 3/4 " tension handle.



ITEM NO.	DESCRIPTION
TOP-N001-19	Meat Saw w/StainlessSteel Blade
TOP-N001-19B	19 1/2" x 5/8" Stainless Steel Blade For Above

STARRETT HOLESAWS
BiMetal Dual Pitch (Deep Cut)



- Dual pitch high speed steel teeth welded to tough alloy body and cap
- 2" cutting depth
- Design allows huge improvements in chip flow
- Suitable for cutting wood, metal and steel
- New box pack has viewing window in corner
- 8% cobalt for greater performance
- Display available for all blades



ITEM NO.	DESC	ITEM NO.	DESC
FCH0058	5/8"	DCH0212	2-1/2"
DCH0034	3/4"	DCH0296	2-9/16"
DCH2532	25/32"	DCH0258	2-5/8"
DCH1036	13/16"	DCH0234	2-3/4"
DCH0078	7/8"	DCH0278	2-7/8"
DCH1056	15/16"	DCH0300	3"
DCH0100	1"	DCH0318	3-1/8"
DCH0116	1-1/16"	DCH0314	3-1/4"
DCH0118	1-1/8"	DCH0338	3-3/8"
DCH0136	1-3/16"	DCH0312	3-1/2"
DCH0114	1-1/4"	DCH0358	3-5/8"
DCH0156	1-5/16"	DCH0334	3-3/4"
DCH0138	1-3/8"	DCH0378	3-7/8"
DCH0176	1-7/16"	DCH0400	4"
DCH0112	1-1/2"	DCH0418	4-1/8"
DCH0196	1-9/16"	DCH0414	4-1/4"
DCH0158	1-5/8"	DCH0438	4-3/8"
DCH1116	1-11/16"	DCH0412	4-1/2"
DCH0134	1-3/4"	DCH0434	4-3/4"
DCH1136	1-13/16"	DCH0500	5"
DCH0178	1-7/8"	DCH0514	5-1/4"
DCH0200	2"	DCH0512	5-1/2"
DCH0216	2-1/16"	DCH0600	6"
DCH0218	2-1/8"	DCH160M	6-5/16"
DCH0214	2-1/4"	DCH168M	6-5/8"
DCH0256	2-5/16"	DCH177M	6-31/32"
DCH0238	2-3/8"	DCH210M	8-9/32"

DISPLAY COMPONENTS



Designed to be used with hooks to hang product
Available at no charge with Starrett stock order.

ITEM NO	DESCRIPTION
PKG5519	12" X 24" Display Board with Backing
PKG5522	24" Header with Graphics
PKG5523	24" Graphics Sign Only
PKG5524	12" Header with Hardware
PKG5525	12" Graphics
PKG5526	Brochure Holder
PKG5529	7" Hook To Be Used on PKG5519



HOLESAW KITS - Bi-Metal Dual Pitch

- Supplied in blown plastic case.

ITEM NO.	DESCRIPTION
KDC06034	Locksmith Kit Contains 1 each: 7/8", 1", 1-1/4", 1-1/2", 1-3/4", 2-1/8" A1E and A10E Arbors, A12 Arbors, Adaptor Pilot Drill
KDC09051	Maintenance Kit Contains 1 each: 3/4", 7/8", 1-1/8", 1-3/8", 1-1/2", 1-3/4", 2", 2-1/4", 2-1/2" A1E, A2E Adaptors, A15-12" Extension, A12 Arbor Adaptor A014CE Pilot Drill



HOLESAWS Diamond Grit



- Used for non metallic cutting.
- Capable of cutting porcelain, glass, ceramics, brick and stone.
- Ideal for kitchen and bathroom installations.
- Clam shell packed.



ITEM NO.	DESCRIPTION	ITEM NO.	DESCRIPTION
KD0096	9/16"	KD0178	1-7/8"
KD0058	5/8"	KD0200	2"
KD1016	11/16"	KD0218	2-1/8"
KD0034	3/4"	KD0214	2-1/4"
KD1036	13/16"	KD0238	2-3/8"
KD0078	7/8"	KD0212	2-1/2"
KD1056	15/16"	KD0258	2-5/8"
KD0100	1"	KD0234	2-3/4"
KD0116	1-1/16"	KD0300	3"
KD0118	1-1/8"	KD0314	3-1/4"
KD0136	1-3/16"	KD0338	3-3/8"
KD0114	1-1/4"	KD0312	3-1/2"
KD0138	1-3/8"	KD0334	3-3/4"
KD0112	1-1/2"	KD0400	4"
KD0158	1-5/8"	KD0414	4-1/4"
KD0134	1-3/4"	KD0412	4-1/2"
		KD0500	5"
		KD0600	6"

ALL OF THE ABOVE
***FOB SURREY, BC ONLY**

PILOT DRILLS

- Clam shell packed.



ITEM NO.	DESCRIPTION
KA014CE	For All Arbors, 4" Long HSS
KXA014C	For All diamond Grit Arbors, 4" Carbide Tip



ARBORS - PARTS



- Arbors supplied with pilot drill.

ITEM NO.	CLAM OR BOXED	DESCRIPTION	EQUIV MORSE #S
A4-E	B	Fits 9/16" - 1-3/16" 1/4" Hex Shank	M34, M44
KA1-E	C	Fits 9/16" - 1-3/16" 11/32" Hex Shank	MK24K
KA10-E	C	Fits 1-1/4" - 8-9/32" 11/32" Hex Shank Quick Hitch	M55P
KA2-E	C	Fits 1-1/4" - 8-9/32" 7/16" Hex Shank Quick Hitch	M35PS
KA19	C	Ops Arbor 13/16" - 1-3/16" for Hole Enlargement	
XA1	B	Arbor with Carbide Tipped Pilot Drill 11/32" Shank Fits 9/16" - 1-3/16"	
XA10	B	Arbor with Carbide Tipped Pilot Drill 7/16" Shank Fits 1-1/4" - 8-9/32"	
XA2	B	7/16" Hex Quick Hitch Arbor With Carbide Drill	
KA15	C	Fits 3/8" Chuck 12" Extension	
KA5	C	Fits 1/2" Chuck 12" Extension	
KA7	C	Ejector Spring	
KA12	C	Arbor Adaptor-To Create Larger Thread	



HACKSAW BLADES



- Bi metal blade and carbon steel blades are suitable for mild steel, copper, brass, aluminum and like materials.
- All hacksaw blades packed in tubes of 10 blades.

ITEM NO.	DESCRIPTION
Bi Metal	
KBS1218-10	12" X 18T 10 Blades per Tube
KBS1224-10	12" X 24T 10 Blades per Tube
KBS1232-10	12" X 32T 10 Blades per Tube
Carbon Steel	
KGF1218-10	12" x 18T 10 Blades per Tube
KGF1224-10	12" X 24T 10 Blades per Tube
KGF1232-10	12" X 32T 10 Blades per Tube



BI METAL JIG SAW BLADES



- Incorporate the Starrett unique process technology.
- Resists breadage, cuts faster and lasts longer than conventional blades.
- All blades have unified shanks which fit most machines.
- Blades are 2 per card.

ITEM NO.	DESCRIPTION	TPI
BU310T-2	3" x 5/16" x 0.050"	10
BU46-2	4" X 3/8" X 0.050"	6
BU418-2	4" X 3/8" X 0.040"	18
BU232-2	2" X 5/16" X 0.40"	32
BU3DC-2	3" X 5/16 X 0.60" Dual Cut (Teeth Cut both Directions)	
BU6	14 Blade Assortment All With Unified Shank	





BI METAL RECIPROCATING SAW BLADES



- Packed 5 blades per pack.

ITEM NO.	DESCRIPTION	TPI	APPLICATION
B66-5	6" X 3/4" X 0.035"	6	General Power
B618-5	6" X 3/4" X 0.035"	18	General Power
BT123-5	12" x 3/4" x 0.050"	3	Tapered General Purpose
BT12610-5	12" x 1" x 0.063"	6-10	Tapered General Purpose
BTR91014-5	9" x 1" x 0.063"	10-14	King Cut Fire, Rescue
BTR121014-5	12" x 1" x 0.063"	10-14	King Cut Fire, Rescue
SB6-A	6" x 3/4" x .035"	i-5 piece set (6, 10, 14, 18, 24 TPI)	



PORTABLE BANDSAW BLADES



- Uses Starrett's bi metal unique technology.
- Uses triple tempered M-42 cobalt high speed steel with fatigue resistant back.
- Twin tooth design allows better cutting and longer lasting.
- Sold in 3 blades per pack.
- Fits B & D, Greenlee Milwaukee, Ridgid, Rockwell, Portor Cable, Skill Unitec.



ITEM NO.	DESCRIPTION	TPI
BM14	1/2" x 0.020" x 44-7/8"	14S
BM18	1/2" x 0.020" x 44-7/8"	18W
BM1014	1/2" x 0.020" x 44-7/8"	10-14P
BM1418	1/2" x 0.020" x 44-7/8"	14-18P

KEY CADDY



- Heavy duty die cast case.
- Supplied with 21" stainless steel chain and key ring.
- Belt clip fastener.



ITEM NO.	DESCRIPTION
SK1	Starrett Key Caddy

CHALK LINES



- Cases hold 4 ounces of chalk.
- 100' Press to release line.
- Supplied with stainless steel hook.



KCS001



KCX001



KCXP005

ITEM NO.	DESCRIPTION
KCS001	Economy Model Hi-Impact ABS Plastic Case, 3.5 X Faster Rewind
KCX001	Mid-range Hi-Impact ABS Plastic Case, 6 X Faster Rewind, Edges are protected with soft touch moulding.
KCXP005	Heavy Duty Aluminum Case with 6 X Faster Rewind. Soft touch edges on case.

CHALK REFILLS



- Bottle supplied with easy handling no spill cap.



ITEM NO.	DESCRIPTION
SC4BLU	4 lb. Bottle Removeable, Blue Colour
SC4RED	4 lb. Bottle Removeable, Red Colour
SUC4BLK	4 lb. Bottle Removeable, Black Colour
SC8B	8 oz Bottle Removeable, Blue Colour
SC8R	8 oz Bottle Removeable, Red Colour
SUC8BLK	8 oz Bottle Permanent, Black Colour

LEVEL - Aluminum

- Anodized to resist corrosion and marking.
- I-Beam design with plastic end caps.
- Top reading with a 90° vial and 45° vial.



ITEM NO.	DESCRIPTION
GWP-98B	24" Aluminum Level



POWER RETURN MEASURING TAPE - ISO 9002 CERTIFIED



- Triple riveted end hook.
- Easy to find fluorescent orange ABS case.
- 16" markings indicated.
- Includes wrist lanyard and belt clip.
- Individually carded.



ITEM NO.	LENGTH	MARKINGS	WIDTH
MT-16ME	16' (5 M)	English/Metric	3/4"
MT-25ME	25' (7.5M)	English/Metric	1"
MT-25EE	25'	English Only	1"

FIBREGLASS MEASURING TAPES



- Metric & standard.
- Light weight ABS Open Reel design.
- Tough, flexible tape.
- Folding rewind handle.
- Ideal for industry or all athletic field measuring.
- Steel claw included.



ITEM NO.	LENGTH	WIDTH
KMC-16002	100 ft. (30m)	1/2"
KMC-16003	200 ft. (60m)	1/2"
KMC-16007	330 ft. (100m)	1/2"

POWER RETURN LOCKING TAPES



- Metric and standard markings.
- Steel tape with high visibility PVC case.
- Red stud markings every 16".
- Positive lock button.
- Triple riveted reinforced blade tip on 25'.
- Acrylic coated blade and padded bumper for extended life.
- Epoxy painted blade tip and belt loop for maximum protection against rust.
- Carded and master packed in convenient counter top display (12 pcs.).
- HI VIS Yellow case.



ITEM NO.	LENGTH	WIDTH
KMC-16N	16 ft. (5m)	3/4"
KMC-25N	25 ft. (7.5m)	1"

FIBREGLASS MEASURING TAPE Open Reel



- One side metric, one side standard measure.
- Markings in 1/8" THS (Standard) and 2mm (Metric).
- Durable plastic body with folding handle.
- Large strong steel claw for positive fastening.



ITEM NO.	LENGTH	WIDTH
JGWF-303	100 ft (30 M)	1/2"

FIBREGLASS MEASURING TAPES



- Metric & standard.
- Tough, flexible, electrically safe, non-conducting tape.
- Life-time ABS resin case with hand strap.
- Flush folding handle, steel claw included.

ITEM NO.	LENGTH	WIDTH
KMC-3301	66 ft. (20m)	1/2"
KMC-3302	100 ft. (30m)	1/2"



VERNIER CALIPER - Plastic

- Blister carded.
- 6" x 150mm range.
- Clear black graduations.
- Calibrated in metric and standard.
- Inside, outside & depth measurements.



ITEM NO.	LENGTH
VC-125	0.05mm (1/128")

VERNIER CALIPERS - Steel

- Supplied with case.
- 6" (150mm) metric and inch scale.
- High quality steel, chrome hardened.
- Easy to read black numbers on satin chrome surface.
- Inside, outside & depth measurements.
- Screw lock.
- Surfaces are ground and lapped to promote smooth slide operation.



ITEM NO.	DESCRIPTION
7910	0.05mm - 1/128" Vernier Scale
7912	0.02mm - 1/1000" Vernier Scale

DIAL CALIPERS - Stainless Steel

- Supplied with case.
- Hardened stainless steel.
- Large dial face.
- Thumb roller and locking screw.
- Inside, outside & depth measurements.



ITEM NO.	DESCRIPTION
VN-150	0" - 6" Capacity (SAE) 0.001" Graduation
VN-150M	0 - 150mm Capacity (METRIC) 0.02mm Graduation

ELECTRONIC DIGITAL CALIPER

- 0" - 6" or 150mm.
- LCD read out.
- Push button control to convert metric to inches.
- "0" reset in any position.
- 1.5 V long life battery included.
- Data output capability for interface with host computer or printer.
- Supplied with case.
- Auto off.
- Inside, outside & depth measurements.
- Graduated slide.
- Large display.



ITEM NO.	DESCRIPTION
M-4306YF	0" - 6" Digital Caliper

DIAL GAUGE

- Satin chrome plated case, back mounting.
- Easy to read face.
- Precision ground hand chrome plated stem, and contact point.



ITEM NO.	DESCRIPTION
200-111	1" Travel 0.001" Reading

MAGNETIC BASE

- Designed to support dial indicators, and other precision measuring devices.
- Specially designed base with "V" groove, has two machined surfaces to allow clamping to straight and round surfaces.
- Powerful alnico permanent magnet.
- Lever type on/off switch.
- 60 kg. holding strength.



ITEM NO.	DESCRIPTION
MB-B	Magnetic Base

OUTSIDE MICROMETERS

- Supplied with case.
- Locking screw included.
- Precision ground.



ITEM NO.	DESCRIPTION
MC-01	0" - 1" Cap. 0.0005" Graduation
MC-01M	(METRIC) 0-25mm Capacity 0.01mm Graduation
MC-02	1" - 2" Cap. 0.0001" Graduation

**HATCHETS AND AXES - "Premium Axes" by Hultafors
Made in Sweden**



- Heads are hand forged.
- All axe heads have curved back for holding when carving.
- Handles are American hickory with linseed oil treatment.
- Handles are wedged with 1 wood wedge and 1 round metal wedge.
- Each axe includes treated leather sheath.
- Each axe packed in individual box.
- Each box has sleeve with history facts and warranty information.

ITEM NO.	DESCRIPTION	NAME	HEAD WEIGHT (grams)	HEAD WEIGHT (LBS)	HANDLE LENGTH
841760	MINI HATCHET	Agelsjon	50	1.10	9"
842760	REPLACEMENT HICKORY HANDLE				9"
841701	HATCHET	Hultan	500	1.10	16"
842085	REPLACEMENT HICKORY HANDLE				16"
840766	SPARE SHEATH	Fits Hultan & Agelsjon			
841770	FOREST AXE	Aby	700	1.54	24"
842770	REPLACEMENT HICKORY HANDLE				24"
840776	SPARE SHEATH				
841710	HUNTING AXE	Ekelund	850	1.87	20"
842710	REPLACEMENT HICKORY HANDLE				20"
840716	SPARE SHEATH	Fits Ekelund & Qvarfot			
841720	FELLING AXE	Quarfot	850	1.87	26"
842720	REPLACEMENT HICKORY HANDLE				26"



**PREMIUM CARPENTER AXE
STALBERG Made in Sweden**

- 4" Straight blade.
- Notch in head to allow holding.
- Hand forged 1.76 lb/800 gram head.
- Supplied with 20" straight hickory handle and leather sheath

ITEM NO.	DESCRIPTION
841730	Premium Carpenters Axe
842730	Replacement Hickory Handle
840736	Spare Sheath



**PREMIUM SPLITTING AXE
HULT Made in Sweden**

- Specially shaped head is hand forged
- All axe heads have curved back for holding when carving
- 36" long straight handle made from American hickory with linseed oil treatment
- Handles are wedged with 1 wood wedge and 1 round metal wedge
- Each axe includes treated leather sheath, packed in individual box and has sleeve with history facts and warranty information.

ITEM NO.	DESCRIPTION
841740	Premium Splitting Axe
842740	Replacement Hickory Handle
840746	Spare Sheath





PREMIUM COMPETITION DB THROWING AXE WETTERHALL Made in Sweden



- 6" Polished cutting edges.
- 8" Tip to tip cutting edge to cutting edge.
- Hand forged 3.5 lb/1600 gram/DB head.
- Supplied with 30" total length hickory handle and leather sheath

ITEM NO.	DESCRIPTION
841750	Double Bit Throwing Axe
842750	Replacement Hickory Handle
840756	Sheath for Double Bit Axe (2 Pce)



SHARPENING STONE



- Leather case with usage instructions.
- Offers 2 grits; 180 grit and 600 grit.
- To be used with water for best results.
- 3" diameter x 1" thick.
- Instruction book included.



ITEM NO.	DESCRIPTION
840792	Sharpening Stone

AGDOR SINGLE BIT MONTREAL PATTERN



- Made in Sweden.
- Hickory handle made by Hultafors.

ITEM NO.	HEAD WEIGHT	HANDLE LENGTH	REPLACEMENT HANDLE
*31-28	2 1/2 lb.	28"	302
*33-28	3 1/2 lb.	36"	205-33

***FOB SURREY, BC ONLY**



AGDOR SINGLE BIT MONTREAL PATTERN MINERS RAFTING AXE - Straight Handle



- Montreal pattern.
- Hickory handle.

ITEM NO.	HEAD WEIGHT	HANDLE LENGTH	REPLACEMENT HANDLE
*48-28	3 1/2 lb.	28"	206-LE

***FOB SURREY, BC ONLY**



ARVIKA BRAND AXES - Made in Sweden BY HULTAFORS



RACING AXE



Arvika - painted head, Agdor
 Arvika - highly polished head.
 Available with smooth or rough grip hickory handle.
 Only used in competition and shake splitting.



ITEM NO.	HEAD WEIGHT	DESCRIPTION	REPLACEMENT HANDLE
*H840500	4 1/2 lb.	Tasmanian Head Only	
*840500	4 1/2 lb.	Tasmanian Axe w/ Rough Grip Hdle	205-RGT
840500-REG	4 1/2 lb.	Tasmanian Axe w/ Smooth Grip Hdle	204-40
*H40-450	4 1/2 lb.	Arvika Head Only	
*40-32	4 1/2 lb.	Arvika Axe w/Rough Grip Hdle	205-RGT
40-32REG	4 1/2 lb.	Arivka Axe w/ Smooth Grip Hdle	204-40

***FOB SURREY, BC ONLY**





ILTIS OX-HEAD BRAND AXES
Made in Germany



- The blade, which is scientifically designed, extraordinarily thin and almost parallel, reduces the weight but doubles the performance.
- Special analysis axe steel, hardened from blade edge to the axe eye by newly developed treatment, guarantees longest durability and excellent cutting effect.
- Science proved that the blade of axe is distorted with each stroke.
- The blade of Iltis axes, however, is more flexible, reduces the danger of breaking considerably, compared to the so-called rigid axes.
- Easier renewal of the edge due to the favourable cross-cut, based on the almost parallel blade.
- Sharpening before chopping is eliminated, because Iltis axes are shipped drawn, ready for use.
- American hickory handles.

ORIGINAL PATTERN - SINGLE BIT WIDE BLADE

ITEM NO.	HEAD WEIGHT	HANDLE LENGTH	REPLACEMENT HANDLE
OX-1001	1 3/4 lbs.	24"	303
OX-1002	2 1/2 lbs.	28"	302-1002 Euro Eye

YANKEE PATTERN - SINGLE BIT

ITEM NO.	HEAD WEIGHT	HANDLE LENGTH	REPLACEMENT HANDLE
OX-2001	1 3/4 lbs.	24"	303

DOUBLE BIT

ITEM NO.	HEAD WEIGHT	HANDLE LENGTH	REPLACEMENT HANDLE
OX-3000	2 1/2 lbs.	28"	208



Please specify ****GRIP**** for Yellow safety grip - available on all hickory handles at an additional charge. Surrey BC warehouse only.
*Handle lengths are measured prior to assembly. Finished length may vary 3/4" - 1 1/4".

OXHEAD COMPETITION AXE
Double Bit Throwing Axe - Made in Germany



- 6" width double blade tip to blade tip, 10 3/4" blade centre to blade centre.
- Tempered to maximum hardness without becoming too hard.
- Satin brushed finish.
- Supplied with leather blade protectors.

ITEM NO.	HEAD WEIGHT	HANDLE LENGTH	REPL HANDLE
OX18-1200	3 lbs.	28" Hickory	208

*H18-1200 3 lbs. Head Only

***FOB SURREY, BC ONLY**



COMPETITION AXE - Made in Germany



- Polished head weighs 6.5 lbs.
- Supplied with 32" hickory handle
- Leather blade guard sheath supplied
- 7 1/2" cutting edge.

ITEM NO.	HEAD WEIGHT	HANDLE LENGTH	REPL HANDLE
OX440-H2708	6 1/2 lbs	32"	HDL-440

*HDL-440 32" Replacement Hickory Handle

***FOB SURREY, BC ONLY**



SPLITTING MAULS



EUROPEAN DESIGN - Made in Germany

- Extra wide splitting angle and blade width.
- High quality steel.
- Supplied with American hickory handle.

ITEM NO.	HEAD WEIGHT	HANDLE LENGTH	REPLACEMENT HANDLE
----------	-------------	---------------	--------------------

*OX-1250 3 lbs. 20" HDL-1250

*OX-5000 5 1/2 lbs. 31" HDL-5000

***FOB SURREY, BC ONLY**





BRUSH HOOK - Made in Germany



- Tempered blade.
- Sharpened on hook side and back side.
- Supplied with genuine hickory handle.
- 28 1/2" overall length 8" length cutting edge.

ITEM NO.	DESCRIPTION	REPLACEMENT HANDLE
OX-0905	28 1/2" Brush Hook	HDL-0905



BEAVER BRAND HATCHET

- Hickory handles.
- Head fastened with round steel wedge and wood wedge.

ITEM NO.	HEAD WEIGHT	HANDLE LENGTH	REPLACEMENT HANDLE
90-150	1.50 lbs	15"	212



CARPENTER'S ADZES - Head Only Made in Germany



ITEM NO.	HEAD WEIGHT
----------	-------------

Straight Pattern:

*H56-51 2 2/3 lbs.

Curved Pattern:

*H56-52 2 1/4 lbs.

*Requires #215, 34" Ash Handle



BEAVER BRAND AXES

- Head fastened with round steel wedge and wood wedge.
- Supplied with hickory handles.

ITEM NO.	HEAD WEIGHT	HANDLE LENGTH	REPLACEMENT HANDLE
91-175	1 3/4 lbs.	26"	200-SM
93-250	2 1/2 lbs.	28"	302



AXES

SINGLE BIT "MINERS (Rafting) AXE" CH UNEX Straight Handle

- Straight high grade American hickory handle.
- Yankee pattern.

ITEM NO.	HEAD WEIGHT	HANDLE LENGTH	REPLACEMENT HANDLE
*16-350	3 1/2 lbs.	28"	206

**FOB SURREY, BC ONLY*

DOUBLE BIT AXE CH UNEX

- American hickory handle.

ITEM NO.	HEAD WEIGHT	HANDLE LENGTH	REPLACEMENT HANDLE
18-350	3 1/2 lbs.	36"	209

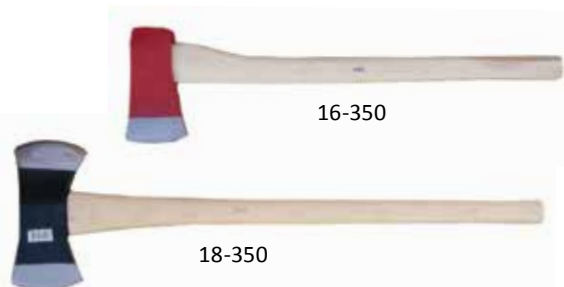

DRAW KNIVES - Made in Germany



- Forged steel with wood handles.

ITEM NO.	DESCRIPTION
----------	-------------

P-7 4 1/2" Handles, 10" Cutting Edge, Straight Edge

P-7CB 3 1/2" Handles, 9" Cutting Edge, Curved Blade



Please specify *"*GRIP"* for Yellow safety grip - available on all hickory handles at an additional charge. Surrey BC warehouse only.

**Handle lengths are measured prior to assembly. Finished length may vary 3/4" - 1 1/4".*



SINGLE BIT AXES
Factory Installed Fibreglass Handles



- Strong Fibreglass core with polypropylene outer housing.
- Rubber hand grip for comfort and safety.

ITEM NO.	HEAD WEIGHT	HANDLE LENGTH
FA-25	2 1/2 lbs.	28"
FA-35	3 1/2 lbs.	36"



HATCHETS, CAMPING AXES



- Hardwood handle.



ITEM NO.	HEAD WEIGHT	HANDLE LENGTH
2015	1 1/4 lbs.	14"

- Fibreglass handle.
- Strong Fibreglass core with polypropylene outer housing.
- Rubber hand grip for comfort and safety.

FA-15	1 1/2 lbs.	15"
-------	------------	-----



PULASKI FIRE AXES



ITEM NO.	HEAD WEIGHT	HANDLE LENGTH	REPLACEMENT HANDLE
----------	-------------	---------------	--------------------

With Wood Handle:

- Pinned for safety.

100-350	3 1/2 lbs.	36"	402
---------	------------	-----	-----

With Fibreglass Handle:

100-350FG	3 1/2 lbs.	34"	N/A
-----------	------------	-----	-----

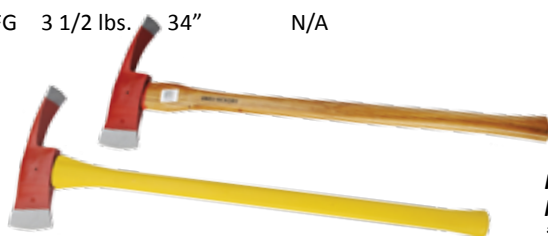

FIRE AXES WITH SPIKE



With High Grade Hickory Handle:

ITEM NO.	HEAD WEIGHT	HANDLE LENGTH	REPLACEMENT HANDLE
97-450	4 1/2 lbs.	36"	304
98-600	6 lbs.	36"	304

With Fibreglass Handle

*97-450FG	4 1/2 lbs.	36"	304-FG
98-600FG	6 lbs.	36"	304-FG

**FOB SURREY, BC ONLY*



HOKKAROON



- Heads drilled for pin.

ITEM NO.	HEAD WEIGHT	HANDLE LENGTH	REPLACEMENT HANDLE
----------	-------------	---------------	--------------------

With Hickory Handle:

15-36	2 lbs.	36"	304
-------	--------	-----	-----

With Fibreglass Handle:

15-36FG	2 lbs.	36"	304-FG
---------	--------	-----	--------



SINGLE BIT YANKEE PATTERN WIDE MAUL HEAD

- Yankee Pattern.
- All 3 1/2 lbs Unex brand axes are pinned.
- Wide maul head

ITEM NO.	HEAD WEIGHT	HANDLE LENGTH	REPLACEMENT HANDLE
----------	-------------	---------------	--------------------

*10-250	2 1/2 lbs.	21"	301
11-250	2 1/2 lbs.	28"	302
*10-350	3 1/2 lbs.	21"	301
*11-350	3 1/2 lbs.	28"	302
*12-350	3 1/2 lbs.	24"	303
*22-350	3 1/2 lbs.	32"	204
23-350	3 1/2 lbs.	36"	304

**FOB SURREY, BC ONLY*



Please specify *"*GRIP"* for Yellow safety grip - available on all hickory handles at an additional charge. Surrey BC warehouse only.
*Handle lengths are measured prior to assembly. Finished length may vary 3/4" - 1 1/4".



SPLITTING MAULS For Wood Splitting

- Oregon pattern.

ITEM NO.	HEAD WEIGHT	HANDLE LENGTH	REPLACEMENT HANDLE
----------	-------------	---------------	--------------------

With Hickory Handles:

Axe Eye:

4806	6 lbs.	36"	236
4808	8 lbs.	36"	236

Sledge Eye:

*6216	6 lbs.	36"	229
*6218	8 lbs.	36"	232

With Fibreglass Handles:

*6416	6 lbs.	34"	229-FG
*6418	8 lbs.	34"	229-FG

***FOB SURREY, BC ONLY**



AXE PROTECTORS & HOLDERS **AXE MATE™**

- Durable one piece polypropylene construction resists cold and heat
- Bright orange velcro strap allows secure holding power yet quick release of axe
- Predrilled for easy fastening to ATV, snow mobile, truck or wall
- AM-250 has belt loop to fasten to belt providing safety and convenience
- Axe handle fastens into flexible tab to secure hand
- Drain holes are built into AXE MATE to allow drainage of any water

ITEM NO.	DESCRIPTION
AM-250	For Most Axes up to 2 1/2 lbs.
AM-350	For Most Axes up to 3 1/2 lbs. Supplied with Belt Loop



Manufactured and Registered Trademark by G Hjukstrom Ltd

CLEARING AXE Made in Sweden

- Supplied with 20" hickory handle.
- 26" Overall length.
- 7" Single cutting blade

ITEM NO.	DESCRIPTION
3022	3 lb. Clearing Axe
3028	Single Blade Replacement Blade for 3022
3029	20" Replacement Handle for 3022



AXE SHEATHS

- Constructed of durable split leather.
- Reinforced with rivets.
- Made with belt loops to fasten onto belt.
- Snap down flap.
- Header card



ITEM NO.	DESCRIPTION
S-3000	Designed To Fit Most 2 1/2 Lbs. Axes
S-3901	Designed To Fit Most 1 1/4 To 1 1/2 Lbs. Hatchets
S-1002	Designed To Fit Ox-1002 (Wide Blade) Most 3 1/2 Lbs. Axes, And Arvika

FELLING AND BUCKING WEDGE

- Made of tough polypropylene.
- Double taper design.
- Packed 10 per carton.

ITEM NO.	DESCRIPTION
46378	7" Long x 3" Wide Wedge (yellow)
46386	10" Long x 3" Wide Wedge (yellow)



Please specify ****GRIP**** for Yellow safety grip - available on all hickory handles at an additional charge. Surrey BC warehouse only.
***Handle lengths are measured prior to assembly. Finished length may vary 3/4" - 1 1/4".**



SPLITTING WEDGE - Steel

- Pointed for easy starting.
- Diamond shape prevents wedge from getting stuck in log.
- Tapered to allow easy driving and notched to hold position.



ITEM NO	DESCRIPTION
TJ-01	3 1/2 lb. Tapered Splitting Wedge

SLEDGE HAMMERS Cont'd With American Hickory Handles



Soft Face Sledge Hammers:

- Made of softer grade steel as required by Workers Compensation Board for certain applications.

*1065-041	4 lbs.	18"	224-55
*1065-042	4 lbs.	28"	226



**FOB SURREY, BC ONLY*

SCRAPER - Steel

- Ideal for scraping ice or removing roofing material.
- Handle socket accepts standard shovel handle.
- Large 4" blade with single bevel 14" overall length.



ITEM NO.	DESCRIPTION	HANDLE REQUIRED
SC-HDL	Scraper w/48" Handle	HDL-04
SC-04	Steel Scraper Head Only	
HDL-04	Handle for SC-04	

SLEDGE HAMMERS - With Fibreglass Handles



- Fibreglass handles are:
 - 10 times stronger than Hickory.
 - Unaffected by moisture and temperature - will not shrink or swell.
 - Will not conduct electricity.
 - Will not be harmed by chemicals.

ITEM NO.	HEAD WEIGHT	HANDLE LENGTH	REPLACEMENT HANDLE
----------	-------------	---------------	--------------------

Standard Sledge Hammers:

1062-041	4 lbs.	14 1/2"	224-FG
1062-06	6 lbs.	36"	228-FG
1062-08	8 lbs.	36"	229-FG
1062-10	10 lbs.	36"	229-FG
1062-12	12 lbs.	36"	229-FG
1062-16	16 lbs.	36"	229-FG
1062-20	20 lbs.	36"	229-FG

Soft Face Sledge Hammers:

- Made of softer grade steel as required by compensation board.

*1067-041	4 lbs.	14 1/2"	224-FG
-----------	--------	---------	--------

**FOB SURREY, BC ONLY*



SLEDGE HAMMERS With American Hickory Handles



- Assembled in our warehouse.

ITEM NO.	HEAD WEIGHT	HANDLE LENGTH	REPLACEMENT HANDLE
----------	-------------	---------------	--------------------

Standard Sledge Hammers:

1060-041	4 lbs.	18"	224-55
1060-042	4 lbs.	28"	226
*1060-043	4 lbs.	24"	n/a
1060-06	6 lbs.	32"	227-SE
1060-08	8 lbs.	36"	229
1060-10	10 lbs.	36"	229
1060-12	12 lbs.	36"	229
1060-16	16 lbs.	36"	232
1060-20	20 lbs.	36"	232

**FOB SURREY, BC ONLY*





SLEDGE HAMMERS Factory Installed Fibreglass Handle



- Home owner grade.
- Stronger than wood.
- Strong plastic coated fibreglass core.
- Unaffected by moisture and temperature, will not shrink or swell.
- Will not conduct electricity.
- Will not be harmed by chemicals.

ITEM NO.	HEAD WEIGHT	HANDLE LENGTH	REPLACEMENT HANDLE
FSH-041	4 lbs	15"	224-FG
FSH-042	4 lbs	24"	229-FG
FSH-06	6 lbs	36"	229-FG
FSH-08	8 lbs	36"	229-FG
FSH-10	10 lbs	36"	229-FG
FSH-12	12 lbs	36"	229-FG



POST MAUL - Head Only

- Head has two large 4" diameter round faces.
 - Hickory handle (Not included with head).
- *To calculate price of complete unit, add head and handle price and order separately.*

ITEM NO.	HEAD WEIGHT	HANDLE NUMBER REQUIRED
*H14	14 lbs.	238
238	36" Hickory Handle	



CLUB HAMMER

- Quality steel head.

ITEM NO.	HEAD WEIGHT	HANDLE LENGTH
Hardwood Handle:		
799-250	2 1/2 lbs.	12"
Factory Installed Fibreglass Handle:		
FST-1250	2 1/2 lbs.	10"



BLACKSMITH HAMMERS Professional



- Head of high quality steel.

ITEM NO.	HEAD WEIGHT	REPLACEMENT HANDLE
With 18" American Hickory Handle:		
3500-3	3 lbs.	224-53
*3500-4	4 lbs.	224-53
With 16" Fibreglass Handle:		
*4500-3	3 lbs.	224-FG
*4500-4	4 lbs.	224-FG
FMH-1500	3 lbs.	224-FG



**FOB SURREY, BC ONLY*

4500-3
4500-4

FMH-1500



SPLITTING MAULS - Fibreglass Handle

- Stronger than wood.
- Poly coated Fibreglass core.
- Rubber grip handle for more secure grip.
- Supplied with 36" epoxy fastened handle.

ITEM NO.	DESCRIPTION
FSM-06	6 lb Fibreglass Handle Maul
FSM-08	8 lb Fibreglass Handle Maul



BALL PEIN MACHINIST'S HAMMERS American Hickory Handles

- Complete with UNEX hickory handles.
- Polished sides.

ITEM NO.	HEAD WEIGHT	HANDLE LENGTH	REPL. HANDLE
*HJ-3008	1/2 lbs.	12"	217
*HJ-3012	3/4 lbs.	12"	218
*HJ-3016	1 lbs.	14"	218
*HJ-3024	1 1/2 lbs.	16"	275
*HJ-3032	2 lbs.	16"	275
*HJ-3040	2 1/2 lbs.	18"	224-53
*HJ-3048	3 lbs.	18"	224-53

**FOB SURREY, BC ONLY*



*Handle lengths are measured prior to assembly. Finished length may vary 3/4" - 1 1/4".



BALL PEIN MACHINIST'S HAMMERS **Fibreglass Handle**

- Polished surfaces.
- Rubber grip.

ITEM NO.	HEAD WEIGHT		HANDLE LENGTH
4016-FG	1 lbs.	(16 oz.)	13"
4024-FG	1 1/2 lbs.	(24 oz.)	14"
4032-FG	2 lbs.	(32 oz.)	15 1/2"
4040-FG	2 1/2 lbs.	(40 oz.)	16 1/2"
4048-FG	3 lbs.	(48 oz.)	17 3/4"



CARPENTER'S CLAW HAMMERS



ITEM NO.	DESCRIPTION
6720T	16 oz. Tubular Steel Handle with Rubber Gripped Handle
6722F	16 oz. Fibreglass Handle with Rubber Gripped Handle
6722W	16 oz. Hardwood Handle included Replacement Handle #221



HAMMERS - Brass (Non-Sparking) Heads by ABC Hammers

- Yellow brass - 406 heads made in USA.
- American hickory handles wedged with specially made brass wedges.
- Ideal for mining, gas plants, maintenance, tool & die makers and many other areas where non sparking is required.

ITEM NO.	HEAD & HANDLE WEIGHT	HEAD DIAMETER	HANDLE LENGTH	HANDLE	DESCRIPTION
*BRH-02	2 lbs	1 1/2"	14"	218	Brass Hammer W/ Hickory Handle And Barrel Head
*BRH-03	3 lbs	1 5/8"	18"	224-03	Same As Above
*BRH-04	4 lbs	1 3/4"	18"	224-03	Same As Above
*BRH-05	5 lbs	1 7/8"	18"	224-55	Same As Above
*BRH-08	8 lbs	2 3/8"	36"	229	Same As Above
*BRH-10	10 lbs	2 1/2"	36"	229	Brass Hammer W/ Hickory Handle And Rectangular Head



ITEM NO.	HEAD & HANDLE WEIGHT	HEAD DIAMETER	HANDLE LENGTH	HANDLE	DESCRIPTION
*BRH-03FG	3 lbs	1 5/8"	14"		Brass Hammer W/ Fibreglass Handle And Barrel Head
*BRH-04FG	4 lbs	1 3/4"	15"	224-FG	Same As Above
*BRH-05FG	5 lbs	1 7/8"	15"	224-FG	Same As Above
*BRH-08FG	8 lbs	2 3/8"	34"	229-FG	Same As Above
*BRH-10FG	10 lbs	2 1/2"	34"	229-FG	Brass Hammer W/ Fibreglass Handle And Rectangular Head



***FOB SURREY, BC ONLY**

*Handle lengths are measured prior to assembly. Finished length may vary 3/4" - 1 1/4".



DEADBLOW HAMMERS



- Strong unicast urethane construction.
- Shockless, non-sparking and non-mar face.
- Head is loaded with shot to eliminate rebound and increase strike force.

ITEM NO.	DESCRIPTION	WEIGHT
DB-200	Deadblow Hammer	2 lbs.
DB-300	Deadblow Hammer	3 lbs.



RUBBER MALLET - White Rubber



- Non-marking.
- Hardwood handles.

ITEM NO.	DESCRIPTION	HANDLE LENGTH
WM-16	16 oz. White Rubber Mallet	11 1/2"
WM-24	24 oz. White Rubber Mallet	12"



RUBBER MALLET - Black Rubber

- 12" hardwood handle.

ITEM NO.	DESCRIPTION	HANDLE LENGTH
C-001	16 oz. Rubber Mallet	12"



FIBREGLASS HANDLES



- 10 times stronger than hickory.
- Will not expand or contract with the variation in temperature.
- Does not absorb water, so it will not swell or shrink when wet or dry.
- Unaffected by corrosive chemicals.
- Will not conduct electricity.
- Outer molded polypropylene structural foam cover is filled with tiny air cells to absorb shock from usage.

FIBREGLASS SLEDGE HAMMER HANDLES Supplied with Epoxy Kit EP-1

ITEM NO.	LENGTH	FOR USE WITH
224-FG	14 1/2"	4 lb. Head
228-FG	34"	6 lb. Head
229-FG	34"	8 lb., 10 lb., 12 lb., 16 lb., 20 lb. Head

FIBREGLASS MAUL HANDLE - With Epoxy Kit

ITEM NO.	LENGTH	FOR USE WITH
228-FG	34"	6416
229-FG	34"	6418

FIBREGLASS AXE HANDLES - With Epoxy Kit

ITEM NO.	LENGTH	FOR USE WITH
304-FG	34"	15-36, 23-350, 98-600, 97-450



EPOXY KIT

- For use with all fiberglass handles.

ITEM NO.	DESCRIPTION
EP-1	Boxed Epoxy Kit



*Handle lengths are measured prior to assembly. Finished length may vary 3/4" - 1 1/4".



SINGLE BIT AXE HANDLES
(See also Fiberglass Handles)



- American hickory.

LIST ITEM NO.	LIST LENGTH	GAUGED TO FIT OUR
200-SM	26" - Boy's Axe	91-175
204	32"	22-350
204-40	32"	40-32 (840500-REG)
*205-RGT	32" - Rough Grip (Serrated) Handle	40-32 (840500)
*205-33	36" Handle	33-28
*206	28" - Miners Straight Std. Eye	48-28, 16-350
*206-LE	28" Handle	48-28
212	15" Handle	90-150
301	21" - Std. Eye	10-250, 10-350
302	28" - Std. Eye	OX-2001, OX-2002 11-250, 11-350
302-1002	28" - Euro Eye	OX-1002 (H10-1200)
303	24" - Std. Eye	OX-1001
304	36" - Std. Eye	23-350, 97-450, 98-600, 15-36
240	36" Red Stained Handle Fits 98-600	FOB DARTMOUTH ONLY

***FOB SURREY, BC ONLY**



DOUBLE BIT AXE HANDLES



- American hickory.

ITEM NO.	LENGTH	GAUGED TO FIT OUR
208	28"	OX18-1200, 18-350 OX-1200, OX-3000
209	36"	18-350 100-350
OxHead Maul Handles		
*HDL-1250	20"	OX-1250
*HDL-5000	32"	OX-5000



Please specify **"*GRIP"** for Yellow safety grip - available on all hickory handles at an additional charge. Surrey BC only.
*Handle lengths are measured prior to assembly. Finished length may vary 3/4" - 1 1/4".

HICKORY SLEDGE HAMMER HANDLES
(See also Fiberglass Handles)



- American hickory replacement handles for Sledges, gauged to fit our heads.

ITEM NO.	DESCRIPTION AND EYE SIZE	GAUGED TO FIT OUR
224-55	18" Sledge - 7/8" x 1 1/8"	4 lbs.
226	28" Sledge - 7/8" - 1 1/8"	4 lbs.
227-SE	32" Sledge - 1" x 1 1/4"	6 lbs.
229	36" Sledge - 1" x 1 1/4"	8 - 10 lbs.
232	36" Sledge - 1 1/4" x 1 1/2"	16 - 20 lbs.



PULASKI AXE HANDLES



ITEM NO.	DESCRIPTION
402	36"



HAMMER HANDLES

- American hickory replacement handles for Standard American Eye.

Machinist's - Ball Pein:

ITEM NO.	DESCRIPTION AND EYE SIZE	GAUGED TO FIT OUR
217	12" - 3/4" x 7/16"	8 - 12 oz.
218	14" - 29/32" x 17/32"	16 - 20 oz.
275	16" - 1 3/16" x 19/32"	24 - 32 oz.
224-53	18" - 1 3/16" x 11/16"	32 - 48 oz.

Carpenter's Hammer and Club Hammer Handles - Adze Eye:

ITEM NO.	DESCRIPTION	TO FIT OUR
221	14" - 9/16 x 1 1/16" Eye Size	6722-W





HAMMER HANDLES - (Continued)

Blacksmith's Hammer Handles:

- American hickory.

ITEM NO.	DESCRIPTION	GAUGED TO FIT OUR
224-53	18" Handle	3500-3, 3500-4



HOOKARON HANDLE

- American hickory.

ITEM NO.	DESCRIPTION	GAUGED TO FIT OUR
304	36" Handle	15-36, 23-350



SPLITTING MAUL HANDLES (See also Fiberglass Handles)

- American hickory.

ITEM NO.	DESCRIPTION	GAUGED TO FIT OUR
229	36" - Sledge, Std. Eye	6216, 6218
236	36" - Straight Handle Axe Eye	4806, 4808



POST MAUL HANDLE

- American hickory.

ITEM NO.	LENGTH	GAUGED TO OUR HEAD NO.
238	36" - Round Eye	#14 (H14)



ADZE HANDLE

- Top grade ash.

ITEM NO.	LENGTH	GAUGED TO OUR HEAD NO.
215	32" Handle	H56-51, H56-52



Please specify **"*GRIP"** for Yellow safety grip - available on all hickory handles at an additional charge. Surrey BC only.
*Handle lengths are measured prior to assembly. Finished length may vary 3/4" - 1 1/4".

PICK HANDLES

- American Hickory.

ITEM NO.	DESCRIPTION	GAUGED TO OUR HEAD NO.
242	36" - Clay, Rock, Cutter, Pick, Railroad, # 6 Eye	2004-600 2004-500 2005-600 2037-500 2045-500 2045-250
*244	36" - Pick Mattock, #10 Eye	2045-250

***FOB SURREY, BC ONLY**



SHOVEL HANDLES - Ash

- Top grade Ash.

ITEM NO.	DESCRIPTION
245	24" - Steel "D" Type with rivets
246	48" - Long Type with rivets



WOOD WEDGES FOR AXES AND SLEDGES

- For assembly of axes and hammers.

ITEM NO.	DESCRIPTION
449-A	66mm - 2 3/16" W x 1/2" H x 3" L
*449-B	64mm - 2 9/16" W x 1/2" H x 3 1/4" L
449-C	70mm - 3 1/2" W x 9/16" H x 2 3/4" L
449-D	66mm - 2 5/8" W x 1/2" H x 2 7/8" L



***FOB DARTMOUTH, NS ONLY**

METAL WEDGES - Triangular

- For assembly of hammers and axes.

ITEM NO.	DESCRIPTION
450-3	1/2" x 1 1/4" (for Small Hammers)
450-4	3/4" x 1 1/4" (for Axes & Medium Sledges)
450-5	1" x 1 1/4" (for Large Sledges)



METAL WEDGES - Round

- For assembly of hammers and wedges
- Reduces risk of splitting.

ITEM NO.	DESCRIPTION
*451-0	15/32" Diameter x 1/2" Long - for Smaller Hammers and Axes
451-1	19/32" Diameter x 19/32" Long - for Larger Hammers and Axes



***FOB SURREY, BC ONLY**

RAKE - Plastic Leaf

- Overall length 1590mm (62”).
- Head size 620mm (24 1/2”) x 550mm (21 1/2”).
- Head is made of black PP, 26 tines.
- Hardwood handle.
- Bent angle of tines to improve ergonomics.

ITEM NO.	DESCRIPTION
----------	-------------

*KW-1409 Plastic Head Rake

**FOB DARTMOUTH, NS ONLY*

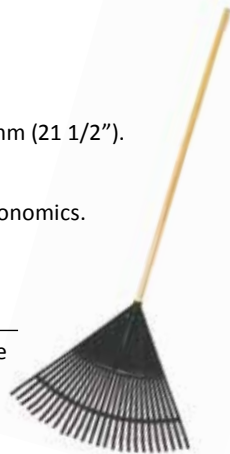

RAKE - Plastic Leaf, Heavy Duty

- Overall length 1740mm (68 1/2”).
- Head size 780mm (30 1/2”) x 285mm (11 1/4”).
- Head is made of black PP, 35 tines.
- Powder coated steel handle.
- Supplied with PVC+PP composite grip.

ITEM NO.	DESCRIPTION
----------	-------------

*KWPBT-35T Plastic Leaf Rake HD

**FOB DARTMOUTH, NS ONLY*

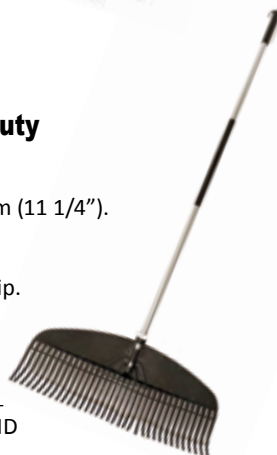

**TRIMMER LINES - SQUARE LINE
Manufactured in the USA**

- Made of durable, long lasting, extruded nylon monofilament.
- Unique formula and special process offer no splitting, minimum fraying and high melting point to reduce line welding.
- Square design offers sharp edges for cleaner cutting and greater strength.

ITEM NO.	LINE SIZE	LENGTH	PACKAGE
TL165-015	0.065” (1.7mm)	50’ (15m)	Loop Clam Shell
TL200-015	0.080” (2.00mm)	50’ (15m)	Loop Clam Shell
TL240-015	0.095” (2.40mm)	40’ (12m)	Loop Clam Shell
TL265-015	0.105” (2.7mm)	30’ (9m)	Loop Clam Shell
TL165-050	0.065” (1.7mm)	270’ (82m)	1/2 lb. Donut Spool
TL200-050	0.080” (2.00mm)	180’ (54m)	1/2 lb. Donut Spool
TL240-050	0.095” (2.40mm)	120’ (36m)	1/2 lb. Donut Spool
TL265-050	0.105” (2.7mm)	100’ (30m)	1/2 lb. Donut Spool
TL165-100	0.065” (1.7mm)	540’ (164m)	1 lb. Donut Spool
TL200-100	0.080” (2.00mm)	355’ (108m)	1 lb. Donut Spool
TL240-100	0.095” (2.40mm)	250’ (76m)	1 lb. Donut Spool
TL265-100	0.105” (2.7mm)	205’ (62m)	1 lb. Donut Spool



FORKS AND RAKES

- Steel heads

ITEM NO.	HEAD MATERIAL	TYPE	HANDLE LENGTH
F-017L	Steel	5 Forged Tine Fork	48” Ash
F-018Y	Steel	4 Forged Tine Fork	28” Ash, D-Grip
R002-14-2FL	Steel	14 Tine Bow Rake	60” Fibreglass Pinned





SHOVELS - Ash Wood Handles

- Supplied with ash-wood handles.

ITEM NO.	BLADE MAT.	TYPE	BLADE LENGTH	HANDLE LENGTH	STEP POSITION
PCL-P	Steel Hollow Back	Square Blade	11 3/4" x 9 1/2"	48"	Rear
PRY-P	Steel Hollow Back	Round Blade	11 3/4" x 8 3/4"	28"	Rear
PCY-P	Steel Hollow Back	Square Blade	11 3/4" x 9 1/2"	28"	Rear
PRL-P	Steel Hollow Back	Round Blade	12" X 8 3/4"	48"	Rear
*PRL-P-2	Steel Hollow Back	Round Blade	11 3/4" x 9 1/2"	48"	Front
*PCL-P-2	Steel Hollow Back	Square Blade	11 1/2" x 9"	48"	Front
PDS-P	Steel Hollow Back	Drain Spade	14 1/2" x 5 1/2"	48"	Front

**FOB SURREY, BC ONLY*



SHOVELS - Fire

- Red painted blade and handle tip.
- Lacquered wood handle.

ITEM NO.	BLADE MATERIAL	TYPE	BLADE LENGTH	HANDLE LENGTH	STEP POSITION
*RFS-P	Steel Hollow Back	Round Blade	11 3/4" x 9 1/2"	45"	Front

**FOB SURREY, BC ONLY*



SHOVELS - Fiberglass Handles

- Supplied with tubular fiberglass handles for light weight and strength.
- Rubber cushion grip for comfort.

ITEM NO.	BLADE MAT.	TYPE	BLADE SIZE	HANDLE LENGTH
81518	Steel Hollow Back	Round Blade	12" x 8 3/4"	48"
82519	Steel Hollow Back	Square Blade	12" x 9 1/2"	48"
97518	Steel Hollow Back	Round Blade	12" x 8 3/4"	28"
97519	Steel Hollow Back	Square Blade	12" x 9 1/2"	28"
97526	Steel Hollow Back	Drain (Track) Shovel	14 1/2" x 5 1/2"	28"



ALUMINUM SHOVELS - Scoops

- Supplied with tubular fiberglass handles for light weight and strength.
- Cushion grip on both 28" and 48" for comfort.
- Aluminum blades are riveted to handle.
- Ribbed blade to add extra strength.

ITEM NO.	TYPE	BLADE SIZE	HANDLE LENGTH
511172	Scoop #8	13" x 17 1/2"	28"
197701	Scoop	15" x 20"	28"
511171	Scoop #8	13" x 17 1/2"	48"
192702	Scoop	15" x 20"	48"
*197700	Scoop	11 3/4" X 16"	28"
*192701	Scoop	11 3/4" X 16"	48"

***FOB DARTMOUTH, NS ONLY**



PICK & MATTOCK - Heads Only

ITEM NO.	DESCRIPTION	OUR HANDLE NUMBER
2004-500	5 lb. Clay Pick	242
2004-600	6 lb. Clay Pick	242
2005-600	6 lb. Rock Pick	242
2037-500	5 lb. Cutter Mattock	242
*2045-250	2 1/2 lb. Pick Mattock	244
2045-500	5 lb. Pick Mattock	242

***FOB SURREY, BC ONLY**

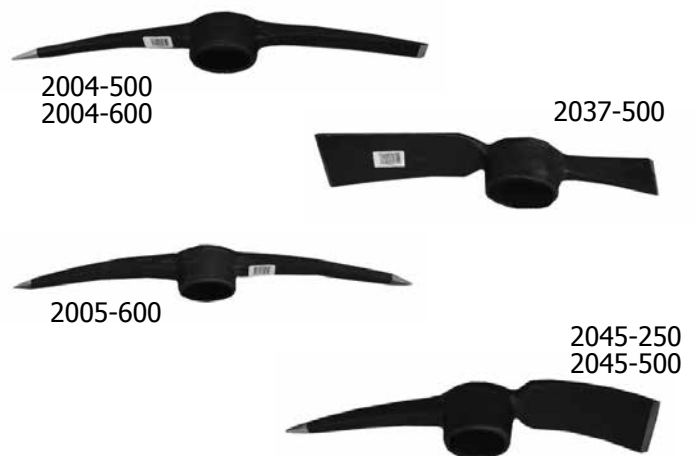



SHOVEL - Collapsible

- Aluminum telescoping handle.
- 10" width x 13 1/2" long plastic scoop.
- Overall collapsed length 27", extended 34 1/2".

ITEM NO.	DESCRIPTION
XP-389808	Collapsible Shovel



SHOVEL - Snow

- Overall length 1390mm (55")
- Head size 363mm (14 1/2") x 480mm (19")
- Head is made of rugged black PP material
- Handle is made from plastic coated steel
- Supplied with black PP "D" grip

ITEM NO.	DESCRIPTION
KW-363	Plastic Snow Shovel



2 IN 1 SNOW TOOL

- Lightweight aluminum construction.
- Snap-fit telescopic handle stows easily.
- Great for emergency kit in vehicles.
- Collapsed length: 17", extended: 30"
- 8" x 10" Blade.

ITEM NO.	DESCRIPTION
KWS-204	10" Multi-Function Shovel



PUSHER - Snow

- Overall length 1300mm (51")
- Head size 285mm (11 1/2") x 620mm (24 1/4")
- Head is made of rugged black PP material
- Handle is made from plastic coated steel
- Supplied with black PP "D" grip

ITEM NO.	DESCRIPTION
KW-620	Plastic Snow Pusher



EXTENDABLE SNOW RAKE

- 24" Polycarbonate/ABS blade.
- 4 x 5' Tubular aluminum handle sections.
- 20.9' Overall handle length.

ITEM NO.	DESCRIPTION
KW-630S	Roof Snow Rake



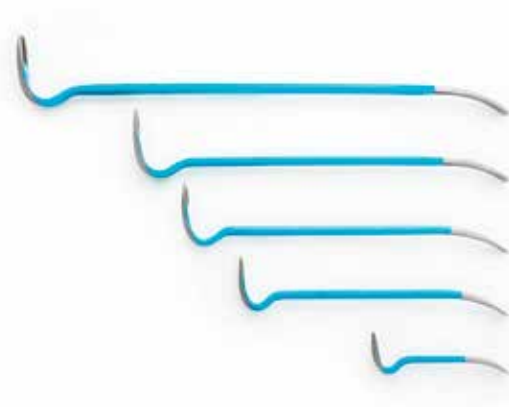

TOVE BARS - Made in Sweden

- A handcrafted wrecking bar offers superior durability compared with a pressed wrecking bar.
- The wrecking bar is forged in specially alloyed steel, and the whole bar is tempered and annealed to handle extremely high loads. The steel alloy and handcrafting give the wrecking bar sprung properties, which enable it to stand up to extreme loads without deforming or breaking.
- The sides of the shaft are octagonal, which gives a better grip than if it was round.
- The wrecking bar’s nail claw is angled at 90 degrees to the shaft, giving the claw good access even right up against a wall or a ceiling.
- Both ends of the bar are thinly ground and have wide, polished tips for ease of insertion under boards, while minimising damage to the surface providing the fulcrum.
- The nail claw has a precision angled V-slot design to allow nails to be pulled regardless of their size and head shape.
- Available in five lengths – 11, 20, 25, 28 and 36 inches.

ITEM NO.	LENGTH	WEIGHT
25-11	11"	1 lb.
25-20	20"	2.5 lbs.
25-25	25"	3.0 lbs.
25-30	28"	3.75 lbs.
25-36	36"	5.0 lbs.





WRECKING BARS Goose Neck

- Made from hexagonal stock.

ITEM NO.	LENGTH	WEIGHT
371-12	12" x 1/2"	0.75 lbs.
371-18	18" x 5/8"	2.00 lbs.
371-24	24" x 3/4"	3.50 lbs.
371-30	30" x 3/4"	4.50 lbs.
371-36	36" x 3/4"	5.00 lbs.



PRY BAR - Japan Type

- Polished faces on both claws.
- Hardened and tempered claws and handle.
- Rounded corners on handle for added comfort.
- Supplied with plastic hanger.

ITEM NO.	LENGTH
LK810-08	8" Pry Bar
LK810-10	10" Pry Bar
LK810-12	12" Pry Bar
LK810-14	14" Pry Bar



UTILITY PRY BAR

- Used for pulling nails, prying, lifting and scraping.
- 3 nail pulling slots.
- 1 1/2" wide high quality carbon steel body.

ITEM NO.	LENGTH	WEIGHT
2024-15	15"	1.5 lbs.



STRIPPING BAR

- Full 1" octagon stock.
- 48" overall length.
- Polished claw tips and prying tip.
- Designed for stripping forms.

ITEM NO.	DESCRIPTION	WEIGHT
SB-12	48" HD Stripping Bar	1.2 lbs.



CROW BARS - Chisel Point

- Point tapered on one side.
- Carbon steel.

ITEM NO.	LENGTH	WEIGHT
CP-12	51"	12 lbs.
CP-14	54"	14 lbs.
CP-16	57"	16 lbs.
CP-18	60"	18 lbs.



CROW BAR - Wedge Point

- Tapered on both sides.
- Carbon steel.

ITEM NO.	LENGTH	WEIGHT
*WP-18	60"	18 lbs.



***FOB SURREY, BC ONLY**

PRY BARS

- Carbon steel.
- One end straight point, one end bent chisel point.
- Made from hexagonal stock.

ITEM NO.	LENGTH	WEIGHT
101-24	24" x 3/4"	3 lbs.
101-36	36" x 3/4"	4.5 lbs.



PRY BAR SET - Screwdriver Handle Type

- Contains one each of:
1/4" x 8", 3/8" x 12", 7/16" x 18", 7/16" x 24" pry bars.
- Sturdy square ABS handles.

ITEM NO.	DESCRIPTION
PBS-4	4 Pc. Pry Bar Set





BRASS PADLOCKS - Carded Gold Lee



- Keyed different.
- Limited key changes
- Solid brass case.
- Hardened steel shackle.
- Double locking.
- Supplied with 3 keys.



ITEM NO.	CASE SIZE	STD. PACK
9010-KD	30 mm. (1 1/4")	12
9015-KD	40 mm. (1 1/2")	12
9020-KD	50 mm. (2")	12

KEY BLANKS FOR BRASS PADLOCKS

ITEM NO.	DESCRIPTION
9015-KB	Key Blanks For 9010 And 9015 Padlocks
9020-KB	Key Blanks For 9020 Padlocks

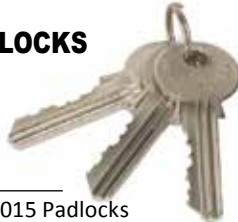

LAMINATED STEEL PADLOCKS



- Steel case with brass plug & pins.
- Hardened steel shackle.
- Supplied with 2 keys.
- Double locking.
- Key blanks available.
- Limited key changes.



KEYED DIFFERENT - Carded

ITEM NO.	CASE SIZE	SHACKLE CLEARANCE	STD. PACK
LP30-KD	30 mm. (1 1/4")	5/8"	12
LP40-KD	40 mm. (1 1/2")	1"	12
LP50-KD	50 mm. (2")	1"	12

LAMINATED STEEL PADLOCKS - Continued



KEYED ALIKE - Boxed

ITEM NO.	CASE SIZE	SHACKLE CLEARANCE	STD. PACK
LP30-KA3	30 mm. (1 1/4")	5/8"	24
*LP30-KA4	30 mm. (1 1/4")	5/8"	24
LP40-KA1	40 mm. (1 1/2")	1"	12
*LP40-KA2	40 mm. (1 1/2")	1"	12
*LP40-KA3	40 mm. (1 1/2")	1"	12
*LP40-KA4	40 mm. (1 1/2")	1"	12
LP50-KA1	50 mm. (2")	1"	12
*LP50-KA2	50 mm. (2")	1"	12

**FOB SURREY, BC ONLY*

KEYBLANKS FOR LAMINATED PADLOCKS

ITEM NO.	DESCRIPTION
LP30-KB	Key Blanks for LP30 Padlocks
LP30-KB-4	Key Blanks for LP30 4 Pin
LP50-KB	Key Blanks for LP40 and LP50 Padlocks



MICOTA PADLOCKS - Brass Case

- All 330 series padlocks are double locking with heel and toe locking mechanism.
- Hardened steel shackles.
- Moisture drain hole on bottom of padlock.
- Rubber gasket around shackle to reduce moisture.
- Solid brass construction.
- Available Keyed Alike or Keyed Different.
- Regular shackle or long shackle available.
- Uses Yale key blanks in most cases.

MICOTA PADLOCKS - Keyed Different

- Regular length shackle KD
- Clam pack.



ITEM NO.	CASE SIZE	SHACKLE CLEARANCE	STD. PACK
36020-KDC	20mm.	(3/4")	1/2"
33030-KDC	30mm.	(1 1/4")	5/8"
33040-KDC	40mm.	(1 1/2")	15/16"
33050-KDC	50mm.	(2")	1 5/32"
33060-KDC	60mm.	(2 3/8")	1 3/16"

*ALL OF THE ABOVE
FOB SURREY, BC ONLY

** Unless a keyed alike group is specified, a group of our choice will be supplied.



MICOTA PADLOCKS Keyed Different - Continued

- Long shackle KD.
- Clam pack.

ITEM NO.	CASE SIZE	SHACKLE CLEARANCE	STD PACK
330464-KDC	40mm.	(1 1/2")	2 1/2"
330490-KDC	40mm.	(1 1/2")	3 1/2"
330564-KDC	50mm.	(2")	2 1/2"
330590-KDC	50mm.	(2")	3 1/2"



ALL OF THE ABOVE
***FOB SURREY, BC ONLY**

MICOTA PADLOCKS Keyed Alike

- Regular length shackle KA boxed.

ITEM NO.	CASE SIZE	SHACKLE CLEARANCE	STD PACK	
33030-KA1	30mm.	(1 1/4")	5/8"	10
33030-KA2	30mm.	(1 1/4")	5/8"	10
33030-KA3	30mm.	(1 1/4")	5/8"	10
33030-KA4	30mm.	(1 1/4")	5/8"	10
33030-KA5	30mm.	(1 1/4")	5/8"	10
33040-KA1	40mm.	(1 1/2")	15/16"	10
33040-KA2	40mm.	(1 1/2")	15/16"	10
33040-KA3	40mm.	(1 1/2")	15/16"	10
33040-KA4	40mm.	(1 1/2")	15/16"	10
33040-KA5	40mm.	(1 1/2")	15/16"	10
33040-KA6	40mm.	(1 1/2")	15/16"	10
33040-KA7	40mm.	(1 1/2")	15/16"	10
33040-KA8	40mm.	(1 1/2")	15/16"	10
33050-KA1	50mm.	(2")	1 5/32"	10
33050-KA2	50mm.	(2")	1 5/32"	10
33050-KA3	50mm.	(2")	1 5/32"	10
33050-KA4	50mm.	(2")	1 5/32"	10
33050-KA5	50mm.	(2")	1 5/32"	10
33060-KA1	60mm.	(2 3/8")	1 3/16"	10
33060-KA2	60mm.	(2 3/8")	1 3/16"	10

ALL OF THE ABOVE
***FOB SURREY, BC ONLY**



MICOTA PADLOCKS - Keyed Alike

- Long Shackle
- Boxed.

ITEM NO.	CASE SIZE	SHACKLE CLEARANCE	STD PACK	
330464-KA1	40mm.	(1 1/2")	2 1/2"	10
330464-KA2	40mm.	(1 1/2")	2 1/2"	10
330490-KA1	40mm.	(1 1/2")	3 1/2"	10
330490-KA2	40mm.	(1 1/2")	3 1/2"	10
330564-KA1	50mm.	(2")	2 1/2"	10
330564-KA2	50mm.	(2")	2 1/2"	10
330590-KA1	50mm.	(2")	3 1/2"	10
330590-KA2	50mm.	(2")	3 1/2"	10



ALL OF THE ABOVE
***FOB SURREY, BC ONLY**

** Please note - 33040-KA1 is Keyed Alike to 330464-KA1 & 330490-KA1
 33050-KA1 is Keyed Alike to 330564-KA1 & 330590-KA1

** Unless a keyed alike group is specified, a group of our choice will be supplied.

KEYBLANKS FOR MICOTA PADLOCKS

ITEM NO.	DESCRIPTION
33030-KB	Fits 30mm Padlock
33040-KB	Fits 40-45mm Padlock
33050-KB	Fits 50-60mm Padlock



WEATHER RESISTANT PADLOCKS

- 40mm steel laminated padlock with ABS enclosed case and rubber keyway plug.
- Hardened shackle with vinyl sleeve and rubber seals.



ITEM NO.	DESCRIPTION	STD. PACK
7000PS-KD	Keyed Different-Carded	12
7000PS-KA3	Keyed Alike Group 3-Bulk	12
7000PS-KB2	Original Keyblank For Above	12

BRASS PADLOCKS



- Hardened steel shackle.
- Solid brass body.
- Double locking bolt (except 20 & 25mm).
- Stainless spring and pin for bolt.
- Pick resistant.
- Brass cylinder plug.
- Stainless spring for pin.
- Stainless spring for shackle.
- Nickel plated brass key.
- Standard Yale keyways.
- Keyed alike groups.
- Long shackle available on 1 1/2" and 2".



PADLOCKS - Keyed Different

ITEM NO.	CASE WIDTH		STD. PACK
10120-KD	3/4"	(20mm)	12
10125-KD	1"	(25mm)	12
10130-KD	1 1/4"	(30mm)	12
10140-KD	1 1/2"	(40mm)	12
10150-KD	2"	(50mm)	6

*Note: 3/4" and 1" single-locking only.

PADLOCKS - Keyed Alike

- Individually boxed.

ITEM NO.	CASE WIDTH		STD. PACK
10330-A	1 1/4"	(30mm)	12
10330-B	1 1/4"	(30mm)	12
10440-C	1 1/2"	(40mm)	12
10440-D	1 1/2"	(40mm)	12
10440-G	1 1/2"	(40mm)	12
10440-H	1 1/2"	(40mm)	12
10550-E	2"	(50mm)	6
10550-F	2"	(50mm)	6
10550-I	2"	(50mm)	6
10550-J	2"	(50mm)	6



PADLOCKS - Keyed Different



- Long Shackle
- Boxed.

ITEM NO.	CASE WIDTH	SHACKLE	STD. PACK
10440-LS65	1 1/2"	2 1/2"	12
10440-LS90	1 1/2"	3 1/2"	12
10440-LS140	1 1/2"	5 1/2"	12
10550-LS65	2"	2 1/2"	12
10550-LS90	2"	1/2"	12



PADLOCKS - Keyed Alike



- Long Shackle
- Boxed.

ITEM NO.	CASE WIDTH	SHACKLE	STD. PACK
10440-C-LS65	1 1/2"	2 1/2"	12
10440-C-LS90	1 1/2"	3 1/2"	12
10440-D-LS90	1 1/2"	3 1/2"	12
10440-C-LS140	1 1/2"	5 1/2"	12
10550-E-LS65	2"	2 1/2"	12
10550-E-LS90	2"	3 1/2"	12

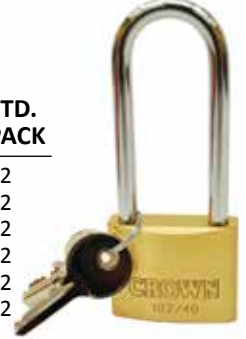

*Note: Above padlocks are Keyed Alike to standard length padlocks with same letter code.

BRASS PADLOCKS



- Hardened shackle
- Heel-toe locking
- Stainless steel springs
- Over 3,000 combinations to prevent key interchanges (not selected in groups)
- Ideal for self storage units
- Boxed in 12's



ITEM NO.	DESCRIPTION
----------	-------------

10140-KD5 40 mm Brass Padlocks KD

CROWN PADLOCKS Semi Assembled



- Ideal for Locksmiths to set up own keying system.
- Supplied with shackle and plug assembled.
- Individually boxed.
- Springs, top pins, pin hole plug, and two keyblanks

ITEM NO.	CASE WIDTH		STD. PACK
*10130-SA	1 1/4"	(30mm.)	12
*10150-SA	2"	(50mm.)	12

LIMITED QUANTITIES
NO BACK ORDERS

***FOB SURREY, BC ONLY**

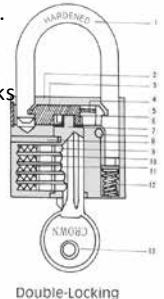

Double-Locking

SEMI ASSEMBLED PARTS



ITEM NO.	DESCRIPTION
*10130-Y8	Crown Keyblanks - 4 Pin - Yale 8 Keyway. Fits 30mm & 40mm Crown Padlocks
*10150-Y9B	Crown Keyblanks - 5 Pin - Yale 9B Keyway. Fits 50mm Crown Padlocks
*10130-99-001	Brass Bottom Pins No. 1
*10130-99-002	Brass Bottom Pins No. 2
*10130-99-003	Brass Bottom Pins No. 3
*10130-99-004	Brass Bottom Pins No. 4
*10130-99-005	Brass Top Pins
*10130-99-006	Brass Pin Hole Plugs
*10130-99-007	Stainless Steel Springs for 10130-SA Padlocks
*10150-99-001	Stainless Steel Springs for 10150-SA Padlocks

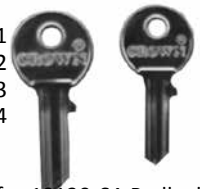

* Note: Minimum order on above parts - 100 pieces.

***FOB SURREY, BC ONLY**

DISC STYLE PADLOCKS - Keyed Different

- Hardened chrome plated shackle.
- Stainless steel outer case.
- Keyed different.
- Attractively clam shell packed.

ITEM NO.	CASE SIZE	DESCRIPTION	STD PACK
260-KD	60mm (2 3/8" Dia)	Disc padlock KD	10
280-KD	80mm (3 1/8" Dia)	Disc padlock KD	10
260-KB	(3 1/8" Dia)	Key Blank for 260,270, 280	6



HEAVY DUTY PADLOCK - Re-keyable

- Hardened steel shackle with hardened solid steel body.
- Ball bearing locking.
- Chrome plated to resist corrosion.
- Removable and rekeyable cylinder.
- Supplied with 3 keys.
- 13/32" dia. Shackle with 2" clearance (closed).
- 2 1/2" dia. x 1 1/8" thick body.
- Boxed.
- Uses A1045 keyway.



ITEM NO.	DESCRIPTION	STD. PACK
465-RLS	HD Padlock Keyed Different	6
465-KB	Key blanks for 465-RLS	

PADLOCKS - E Type Armoured Padlock

- "E" shaped padlock to offer high security when used with chain or hasp.
- Hardened case, shackle pin and keyway protector.
- Chrome body to resist corrosion.
- Will accept up to 3/8" chain (.41" capacity).
- Shackle pin rotates freely to resist cutting.

ITEM NO.	DESCRIPTION
BF70-KD	70mm Padlock KD Clam Shell Pack
BF70-KA1	70mm Padlock KA Bulk Pack
BF70-KB	Keyblank For Above



PADLOCKS - Re-Keyable

- Re-keyable to Weiser and Schlage specifications.
- Supplied "O" biting or keyed different with 2 keys.
- Ball bearing locking.
- Brush chrome plated brass body.
- Molybdenum shackle.
- Supplied with 1" clearance shackle.



ITEM NO.	DESCRIPTION
PLB45-1-SLG-KO	45 mm Padlock Satin Chrome, Schlage Keyway "O" Biting
PLB45-1-WR-KO	45 mm Padlock Satin Chrome, Weiser Keyway "O" Biting
PLB45-1-SLG-KD	45 mm Padlock Satin Chrome, Schlage Keyway KD
PLB45-1-WR-KD	45 mm Padlock Satin Chrome, Weiser Keyway KD
PL-SHACKLE-1-MA	1" Shackle For PLB45 Padlock
PL-SHACKLE-2-MA	2" Shackle For PLB45 Padlock
PL-SHACKLE-3-MA	3" Shackle For PLB45 Padlock

DOOR LOCKS - SPARTAN BRAND

- Available in visual pack or box pack.
- Suitable for 1 3/8" - 2" thick doors.
- Manufactured to meet ANSI specs for grade 3.
- 4 way latch suitable for 2 3/8"-2 3/4" backset.
- Drive in or mortise face place plate.



ENTRANCE LOCKSETS - Tubular Type

- Weiser keyway.
- Easily re-keyable.



ITEM NO.	FUNCTION	PACK	KNOB FINISH	DESIGN
6871PB	Entrance	Visual	Polished Brass	Ball
6871SC	Entrance	Visual	Satin Chrome	Ball
*6871PB-B	Entrance	Box	Polished Brass	Ball
*6871SC-B	Entrance	Box	Satin Chrome	Ball

***FOB SURREY, BC ONLY**

PASSAGE SETS - Tubular Type



ITE NO.	FUNCTION	PACK	KNOB FINISH	DESIGN
6873PB	Passage	Visual	Polished Brass	Ball
6873SC	Passage	Visual	Satin Chrome	Ball
*6873PB-B	Passage	Box	Polished Brass	Ball
*6873SC-B	Passage	Box	Satin Chrome	Ball

***FOB SURREY, BC ONLY**

DOOR LOCKS - CONTINUED

PRIVACY SETS - Tubular Type

- Turn button locking.
- Emergency key opening from outside.

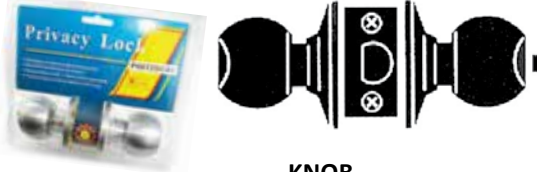

ITEM NO.	FUNCTION	PACK	KNOB FINISH	DESIGN
6872PB	Privacy	Visual	Polished Brass	Ball
6872SC	Privacy	Visual	Satin Chrome	Ball
*6872PB-B	Privacy	Box	Polished Brass	Ball
*6872SC-B	Privacy	Box	Satin Chrome	Ball

***FOB SURREY, BC ONLY**

LEVER DOOR LOCKS - SPARTAN BRAND

- Box packed.
- Suitable for 1 3/8" - 2" thick doors.
- Manufactured to meet ANSI specs for grade 3.
- 4 way latch suitable for 2 3/8" - 2 3/4" back set and for drive-in or mortise face plates.



ENTRANCE LOCKSETS - Lever Handle Tubular Type

- Weiser keyway.
- Easily rekeyable.

ITEM NO.	FUNCTION	FINISH	HANDLE DESIGN
6411PB	Entrance	Polished Brass	Straight Lever
6411SC	Entrance	Satin Chrome	Straight Lever

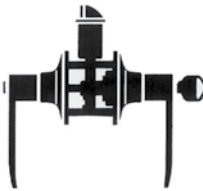

PRIVACY SETS - Lever Handle Tubular Type

- Turn button locking.
- Emergency key opening from outside.

ITEM NO.	FUNCTION	FINISH	HANDLE DESIGN
6412PB	Privacy	Polished Brass	Straight Lever
6412SC	Privacy	Satin Chrome	Straight Lever



PASSAGE SETS - Lever Handle Tubular Type

ITEM NO.	FUNCTION	FINISH	HANDLE DESIGN
6413PB	Passage	Polished Brass	Straight Lever
6413SC	Passage	Satin Chrome	Straight Lever



DEAD-BOLTS - SPARTAN BRAND

- Weiser keyway.
- 4 way bolt, adjustable for 2 3/8" - 2 3/4" back-set.
- Drive in or mortise faceplate.
- Crush resistant cylinder rings.
- Supplied with HD security strike with extra long screws.

ITEM NO.	FUNCTION	FINISH	PACKAGE
7301PB	Single Cyl Dead-bolt	Polished Brass	Display Pack
7301SC	Single Cyl Dead-bolt	Satin Chrome	Display Pack
*7301PB-B	Single Cyl Dead-bolt	Polished Brass	Boxed
*7301SC-B	Single Cyl Dead-bolt	Satin Chrome	Boxed
7312PB	Double Cyl Dead-bolt	Polished Brass	Display Pack
7312SC	Double Cyl Dead-bolt	Satin Chrome	Display Pack

***FOB SURREY, BC ONLY**



Single Cylinder



Double Cylinder

COMBO LOCK-SET - Entrance Set & Single Cylinder Dead-bolt Combination - SPARTAN BRAND

- Clamshell packaged.
- Suitable for 1 3/8" - 1 3/4" thick doors.
- Adjustable back-sets 2 3/8" - 2 3/4".
- Drive in or mortise faceplates.
- Weiser keyway.
- Dead-bolt has heavy duty security strike with extra long screws included.
- Dead-bolt has crush resistant cylinder rings.
- Both dead-bolt and entrance lock are keyed alike.
- Supplied with 4 keys.

ITEM NO.	DESCRIPTION	FINISH
6871PB-2	Combo Entrance Set/ Single Cylinder Dead-bolt	Polished Brass Finish
6871SC-2	Combo Entrance Set/ Single Cylinder Dead-bolt	Satin Chrome Finish



ELECTRONIC DIGITAL DEADBOLT

- Keyless entry convenience
- One touch locking and automatic locking
- Will accept 50 codes plus master code
- Fits standard doors and cut outs
- Weiser keyway
- High security strike plate included
- Uses 4AA batteries
- 1 Year mechanical warranty and 1 year finish warranty
- Attractively boxed

ITEM NO.	DESCRIPTION
DLE-3101-SN	Touch Screen, Satin Nickel Finish
DLE-3101-11P	Touch Screen, Dark Bronze Finish
DLE-3201-SN	Push Button, Satin Nickel Finish
DLE-3201-11P	Push Button, Dark Bronze Finish



DLE-3101-SN
DLE-3101-11P



DLE-3201-SN
DLE-3201-11P



ALL OF THE ABOVE
***FOB SURREY, BC ONLY**

DEADLOCKS - Throwbolt

- 31/32" and 1 1/8" back set.
- Aluminum finish.
- With faceplate.
- Adams Rite Cutout.



ITEM NO	DESCRIPTION
1850A-1	Adams Rite Cutout Deadbolt 31/32" Backset
1850A-2	Adams Rite Cutout 1 1/8" Backset
*1599A	Faceplate For Adams Rite Cutout
*1851A-1	A/R Cut Out Hook Bolt 31/32" Backset
*1851A-2	A/R Cut Out Hook Bolt 1 1/8" Backset

***FOB SURREY, BC ONLY**

DEAD LATCHES

- 31/32" and 1 1/8" backset.
- Includes strike and faceplate.
- Adams Rite cutout.
- Metal latch bolt with plastic insert.



ITEM NO.	DESCRIPTION
4510A-1	31/32" Backset With Aluminum Finish
4510A-2	1 1/8" Backset With Aluminum Finish

LEVER HANDLES FOR 4510 DEAD LATCH

- Reversible cam included.

ITEM NO.	DESCRIPTION
4560-AL	Aluminum Finish



LATCH PADDLES FOR 4510 DEADLATCH

- Aluminum and duranodic finish.
- Suitable for 1 3/4" door thickness.
- Reversible handing.
- Supplied with cam.
- Push label not attached.

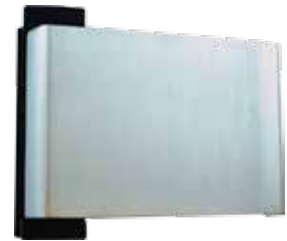

ITEM NO.	DESCRIPTION
4590-AL	Left or Right available, Aluminum Finish
4590-DU	Left or Right available, Duranodic Finish

FLUSH BOLT - Lever Type

- Mortise flush bolt for aluminum doors.
- Zinc diecast face and lever mechanism.
- Supplied with 10" steel threaded rod, nylon bolt, nylon guide and mounting screws.

ITEM NO.	FACE SIZE	FINISH	BACK-SET	MOUNTING HOLE C-C	BOLT THROW
5506-AL	4 7/32" x 15/16"	Sprayed Aluminum	1/8"	5 1/4"	5/8"





MORTISE CYLINDERS

- Solid brass mortise cylinder (measured under collar to back of cam).
- Supplied with M/S cam.
- Satin Chrome and Duranodic finish.
- Available in Schlage/Weiser Keyway.
- Supplied with 2 keys.



ITEM NO.	LENGTH	DESCRIPTION
1370CW	1"	KA In Pairs-Weiser Keyway-Satin Chrome
1370DW	1"	KA In Pairs-Weiser Keyway-Duranodic
1370CS	1"	KA In Pairs-Schlage "C" Keyway-Satin Chrome
*1371CW	1 1/8"	KA In Pairs-Weiser Keyway-Satin Chrome

***FOB SURREY, BC ONLY**

MORTISE THUMB TURNS AND DUMMY CYLINDERS

- 1" Solid Brass

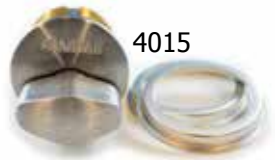

ITEM NO.	DESCRIPTION
4010-AL	Dummy Cyl., Aluminum Finish
4010-DU	Dummy Cyl., Duranodic Finish
4015-AL	Thumb Turn, Aluminum Finish
4015-DU	Thumb Turn, Duranodic Finish

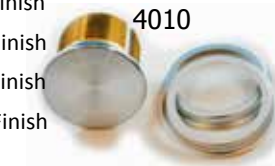

MORTISE THUMB TURNS - Captive Key

- Allows thumb turn to be in cylinder during work hours.
- For security reasons thumb turn can be removed when all staff have left the building
- 1 1/8" length.



ITEM NO.	DESCRIPTION
*CM118-WRE	Weiser Keyway Captive Mortise Cylinder Satin Chrome Finish
*CM118-SLGC	Schlage Keyway Captive Mortise Cylinder Satin Chrome Finish
*CM-KEY-SC	Key Blank For Above Supplied with Release Key

***FOB SURREY, BC ONLY**

CYLINDER SPACER RINGS

- Made of aluminum.
- Available in 3 sizes.
- Aluminum finish.
- Packed 10/pack.

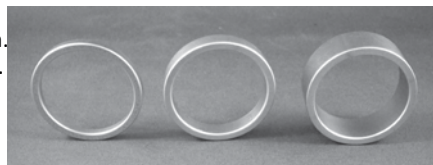

ITEM NO.	DESCRIPTION
*AR354-03	3mm Aluminum Spacer Ring
*AR354-06	6mm Aluminum Spacer Ring
*AR354-12	12mm Aluminum Spacer Ring

***FOB SURREY, BC ONLY**

CYLINDER GUARD RINGS

- Satin chrome rings
- Available in 2 sizes to accommodate 1" - 1 1/8" cylinders
- Sold in bags of 10 pieces
- Supplied with wave washer



ITEM NO.	DESCRIPTION
*BR431-113-SC-V	Satin Chrome Guard Rings 1/4" Inside Step
*BR431-147-SC-V	Satin Chrome Guard Rings 3/8" Inside Step



***FOB SURREY, BC ONLY**

KNOB PROTECTOR - Heavy Duty (Used for Cut-Off Lever Handles)

- Made of solid brass to resist attack.
- Large 3 9/16" opening on back to accommodate large escutcheons.
- Supplied with bolts, template and hole marking set screws.
- Satin chrome finish.

ITEM NO.	DESCRIPTION
*KP802-26D	Heavy Duty Knob Protector Satin Chrome Finish

***FOB SURREY, BC ONLY**



LEVER PROTECTOR (Used for Cut-Off Lever Handles)

- Made of aluminum.
- Large 3 9/16" opening on back to accommodate large escutcheons.
- Supplied with bolts, template and hole marking set screws.
- Black painted finish.

ITEM NO.	DESCRIPTION
*KPA02-BLK	Lever Protector Matte Black Painted

***FOB SURREY, BC ONLY**



KNOB PROTECTOR

- Black hammer-tone finished aluminum.
- Complete with screws.
- Large 3 1/8" capacity.
- 2 1/16" screws supplied.

ITEM NO.	DESCRIPTION
*KPA-01	Aluminum Alloy Knob Protector

***FOB SURREY, BC ONLY**



KNOB PROTECTOR WITH PULL

- Designed to fit 3 5/16" rosette and 5/8" thickness
- Heavy aluminum body
- Supplied with carriage bolts
- Powder coat finish



ITEM NO.	DESCRIPTION
KPA03	Knob Protector
KPA03-1-5	Spacer 7/32" Thick Accepts 3 5/16" Rosette
KPA04	Lock Guard Exit Only with Screws

ALL OF THE ABOVE
***FOB SURREY, BC ONLY**

DOOR CYLINDER GUARDS - For Aluminum Doors

- Prevents pulling and twisting of cylinders by covering cylinder except for keyway area.
- Made of aluminum alloy.
- Supplied complete with 1/2" face and 1 x 1/8" spacer and thru-bolts.
- Available in aluminum and 10B (DU) finish.
- Overall dimensions 1 3/4" W x 8 1/4" L x 1/2" thick.

ITEM NO	DESCRIPTION
MP04-AB-SC	Cylinder Guard for Abloy Cylinders, Aluminum Finish
MP04-AB-DU	Cylinder Guard for Abloy Cylinders, 10B Finish
MP04-ST-SC	Cylinder Guard for Standard Mortise Cylinders, Aluminum Finish
MP04-ST-DU	Cylinder Guard for Standard Mortise Cylinders, 10B Finish
MP04-18-SC	1/8" Spacer for MP04, Aluminum Finish
MP04-18-DU	1/8" Spacer for MP04, 10B Finish

DEADBOLT CYLINDER GUARD

- Supplied with plated carriage bolts with acorn nuts.
- Included are 2 back plates.
- 1 1/16" depth.
- Individually boxed.

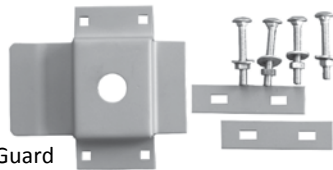

ITEM NO.	DESCRIPTION
*LP007-G	Deadbolt Cylinder Guard

***FOB SURREY, BC ONLY**



ALL OF THE ABOVE
***FOB SURREY, BC ONLY**

MORTISE CYLINDER GUARDS

- Used to prevent plier attack to mortise cylinders.
- 1/4" deep recess to accommodate cylinder face.
- Made of corrosion resistant alloy.
- Attractively carded.



ITEM NO.	DESCRIPTION
MP01-SC-V	1 5/8" X 4" 4-Hole Model With 4 Rivet Fastening. Satin Chrome Finish
MP01-10B-V	1 5/8" X 4" 4-Hole Model With 4 Rivet Fastening. Dark Bronze Finish
MP02-SC-V	1 1/2" X 4 1/2" Narrow Style 2-Hole Model With 1 Rivet And 1 Thru-Bolt. Satin Chrome Finish
MP02-10B-V	1 1/2" X 4 1/2" Narrow Style 2-Hole Model With 1 Rivet And 1 Thru-Bolt. Dark Bronze Finish

ALL OF THE ABOVE
***FOB SURREY, BC ONLY**

LATCH PROTECTOR / INTERLOCK PLATE

- Steel construction.
- Supplied with non-removable security screws
- Carded.



ITEM NO.	DESCRIPTION
LP001-PBV	Brass Latch Protector - 11" Length (Offset Type)
LP004-10B-V	Duranodic Latch Protector - 12" Length ("U" Type)
LP004PBV	Polished Brass Latch Protector - 12" Length ("U" Type)
LP004SCV	Satin Chrome Latch Protector - 12" Length ("U" Type)
LP004WHTV	White Latch Protector - 12" Length ("U" Type)

ALL OF THE ABOVE
***FOB SURREY, BC ONLY**

LATCH PROTECTORS - For Wood or Metal Doors

- Lock protection for out-swinging doors.
- Supplied with 2 1/4" bolts with chrome acorn nuts.
- Covers strike plate.
- Carded.

ITEM NO.	DESCRIPTION	FINISH	STD. PACK
804-CAD	11" x 3"	Aluminum	6
804-DU	11" x 3"	Duronodic	6



LATCH PROTECTORS For Aluminum Doors

- Lock protection for aluminum out-swinging doors.
- 12" x 3 1/2" heavy gauge steel.
- Covers strike plate.
- Carded.

ITEM NO.	SIZE	FINISH
LG-111-AL	12" x 3 1/2"	Aluminum
LG-111-DU	12" x 3 1/2"	Duronodic



BUTT HINGES - Standard Duty Template RP and NRP

- Steel with steel pins.
- 2 ball bearings.
- 5 knuckle.
- Flat button tips.
- Square corner.
- Supplied with full machine screws and full wood screws.
- Packed in 1 1/2 pair per box.



Removable

ITEM NO.	DESCRIPTION	STD. PACK
BHNP-4045	4 1/2" x 4" Nickel Plated Removable Pin	16 sets
BHBP-4045	4 1/2" x 4" Dark Bronze Plated Removable Pin	16 sets
BHNP-4045-NRP	4 1/2" x 4" Pin Nickel Plated Non-Removable	16 sets



Non-Removable

DOOR CLOSERS



- 2-year warranty.
- ULC labelled.
- Narrow style, cast aluminum
- Reversible, suitable for left or hand doors.
- Rack and pinion mechanism.
- Adjustable arm.
- Parallel arm bracket included



ITEM NO.	DESCRIPTION	RECOMM. DOOR WT.	WT. EACH
----------	-------------	------------------	----------

Standard Arm Application:

K-720-AL	No. 2, Two Valve Latch & Closing Speed Adjustment, Aluminum Hole Centre: 6 9/16" C-C	55 - 99 lbs.	4.75 lbs.
K-730-AL	No. 3, Two Valve Latch & Closing Speed Adjustment, Aluminum Hole Centre: 8 1/16" C-C	88 - 143 lbs.	5.0 lbs.
D-740BC-AL	No. 4, Latch, Closing, & Back Check Adjustment, Aluminum Hole Centre: 9 1/16" C-C	132 - 187 lbs.	5.5 lbs.
D-750BC-AL	No. 5, Latch, Closing, & Back Check Adjustment, Aluminum Hole Centre: 9 1/16" C-C	176 - 264 lbs.	6.0 lbs.

PARTS

ITEM NO.	DESCRIPTION
20-5-AL	Drop Plate for D740 & D750, Aluminum Finish
20-1-AL	Parallel Arm Bracket for all Unex closers, Aluminum Finish



DOOR PULL

- Zinc plated.
- Supplied with screws.
- 6 1/2" overall length with 5 1/2" hole centres.
- 1" clearance for hand hole.
- Poly bagged.

ITEM NO.	DESCRIPTION
1421-65	6 1/2" Door Pull



HEAVY DUTY BARREL BOLT

- 19/32" bolt with padlock lock open, lock closed holes.
- Supplied with 4 carriage bolts, 4 wood screws and mortise staple.
- Plated to resist corrosion.
- Carded.

ITEM NO.	DESCRIPTION	MASTER PACK
F83250	6" Overall Length Barrel Bolt	48
F83280	8" Overall Length Barrel Bolt	48



BARREL BOLTS - Zinc Plate

- Screws not included.

ITEM NO.	SIZE	STD BOX	WEIGHT PER MASTER PACK	MASTER PACK
21102C	2 1/2"	30	33 lbs.	300
21103C	3"	30	47 lbs.	300
21104C	4"	20	47 lbs.	200
21105C	5"	15	40 lbs.	150
21106C	6"	12	55 lbs.	120



HASPS - Zinc Plated

- Screws not included.

ITEM NO.	SIZE	STD. BOX	WEIGHT PER MASTER PACK	MASTER PACK
12203C	3"	30	20 lbs.	300
12206C	4 1/2"	12	55 lbs.	240
12208C	6"	15	53 lbs.	150



T HINGES - Zinc Plated

- Screws not included.
- Sold in pairs.

ITEM NO.	SIZE	STD. BOX	MASTER PACK
10201	4"	10	100
10203	6"	7 1/2	60
10204	8"	5	30
10205	10"	3	24



STRAP HINGES - Zinc Plated

- Screws not included.
- Sold in pairs.



ITEM NO.	SIZE	STD. BOX	MASTER PACK
11201	4"	5	100
11203	6"	5	100
11204	8"	5	30

KEY CADDY

- Heavy duty die cast case
- Supplied with 21" stainless steel chain and key ring
- Belt clip fastener

Starrett®

ITEM NO.	DESCRIPTION
SK1	Starrett Key Caddy



CARABINER HOOKS WITH KEY RINGS

- Supplied in assorted anodized aluminum colours.
- Comes with 1" split ring.
- 12 Carabiner hooks per card.



ITEM NO.	DESCRIPTION
CAR2-12	60mm. (2 3/8") (Medium) Overall Length
CAR3-12	80mm. (3 1/8") (Large) Overall Length

CLIP-ON KEY REELS

- Nickel plated.
- 24" extended length.
- Tempered belt clip.

ITEM NO.	DESCRIPTION
*62C	6 Pcs. Per Card

***FOB SURREY, BC ONLY**



PULL APART

- Nickel plated.
- 3 1/8" overall length includes (2) 7/8" split rings.

ITEM NO.	DESCRIPTION
C5-24	24 Pcs Display



KEY COVER

- Rubber-like vinyl.
- Assorted colours per box.



ITEM NO.	DESCRIPTION
ID880-N	200 Pcs Per Box

KEY CAPS - Neon

- Rubber-like vinyl.
- Assorted colours.



ITEM NO.	DESCRIPTION
ID990-N	Medium Size 200 Per Box
ID995-N	Jumbo Size 200 Per Box

JOGGER'S COILS

- Assorted colours per card.



ITEM NO.	DESCRIPTION
*JO42N-24	24 Pcs Per Card

***FOB SURREY, BC ONLY**

WRIST COILS

- Assorted colours per card.



ITEM NO.	DESCRIPTION
*JO43N-24	24 Pcs Per Card

***FOB SURREY, BC ONLY**

HIGH SECURITY METAL BELT HOOKS

- Release lever must be activated before keys and key ring can be removed.
- 2 1/8" overall length also includes a 1 1/4" split ring.



ITEM NO.	DESCRIPTION
*KP1223-12	12 Pcs Per Card

***FOB SURREY, BC ONLY**

NECK LANYARDS

- 32" length with 1 1/4" split ring.
- 360° rotating swivel.
- Black and Red colours.



ITEM NO.	DESCRIPTION
*LN100-24	24 Pcs Per Card

***FOB SURREY, BC ONLY**

MAGNETIC KEY CASE

- Heavy duty non-rusting plastic with extra strong magnets.
- Measures 3" x 1 3/4" x 5/8" - holds a key up to 2 11/16" x 1 3/16".



ITEM NO.	DESCRIPTION
*MC-24	24 Pcs Per Card

***FOB SURREY, BC ONLY**

JUMBO MAGNETIC KEY CASE

- Heavy duty non-rusting plastic with extra strong magnets.
- Designed to accommodate today's oversized keys.
- Internal capacity: 3 1/4"L x 1 1/2" W x 1/2"D.



ITEM NO.	DESCRIPTION
*MS2-12	12 Pcs Per Metal Card

***FOB SURREY, BC ONLY**

SPLIT RING ASSORTMENT

- Nickel plated tempered steel (except 2").
- 5/8" to 2" includes spring sleeve key rings.

ITEM NO.	DESCRIPTION
*SR-848	375 Pc Display

***FOB SURREY, BC ONLY**



SPLIT KEY RINGS

- Nickel plated.
- Sizes are approximate inside dimensions.



ITEM NO	DESCRIPTION	ACTUAL INSIDE DIMENSIONS	QUANTITY PER BAG
SR-74758X	5/8" Round	11/16	100
SR-74734X	3/4" Round	3/4	100
SR-74778X	7/8" Round	13/16	100
SR-7471X	1" Round	1 1/32	100
SR-747118X	1 1/8" Round	1 3/16	100
SR-747114X	1 1/4" Round	1 1/4	100
SR-747138X	1 3/8" Round	1 3/8	100
SR-747112X	1 1/2" Round	1 5/8	100
SR-7472X	2" Round	2 1/16	50

ALL OF THE ABOVE
***FOB SURREY, BC ONLY**

KEY TAGS

- Supplied with 3/4" split ring.
- Paper insert with protective plastic cover.
- Counter top display includes assorted colours of purple, yellow, green, red, dark blue, light blue, raspberry and orange.

ITEM NO.	DESCRIPTION
KL980-R	200 Pcs Per Box



KEY TAGS

- Supplied with 9/16" plated split ring.
- Paper insert with protective cover.
- Tag measures 2" x 7/8".
- Ideal for key cabinets and other uses where individual colours are required.
- Packed 50/bag per colour.

ITEM NO.	DESCRIPTION
KL980-BLU	Blue Key Tag
KL980-GRN	Green Key Tag
KL980-ORG	Orange Key Tag
KL980-RED	Red Key Tag
KL980-WHT	White Key Tag



KEVRON KEY TAGS Made in Australia



- High quality polypropylene key tags.
- Large 1 1/4" x 1" ID card size.
- Strong lens and locking mechanism.
- Consistency in tag colours.
- Supplied with Stainless Steel rings.
- Ideal for Office, Home, Real Estate Agents, Car Dealers & Motels.



ITEM NO.	DESCRIPTION
ID5-AC100	100 Loose Tags. Assorted Colours in Counter Top Display
ID5-AC150	150 pce. Standard Click Tags In Fish Bowl Container
ID5-RED	50 Red Loose Tags In Poly Bag
ID5-BLU	50 Blue Loose Tags In Poly Bag
ID5-GRN	50 Green Loose Tags In Poly Bag
ID5-ORG	50 Orange Loose Tags In Poly Bag
ID5-YEL	50 Yellow Loose Tags In Poly Bag
ID5-NAT	50 Natural Loose Tags In Poly Bag

NEW FLOURESCENT COLOURS: Loose Tags in Poly Bag

- *ID38-GRN 50 Fluorescent Green
- *ID38-ORG 50 Fluorescent Orange
- *ID38-PNK 50 Fluorescent Pink
- *ID38-YEL 50 Fluorescent Yellow

NEW JAZZ COLOURS: Loose Tags in Poly Bag

- *ID50-BLU 50 Jazz - Blueberry
- *ID50-GRP 50 Jazz - Grape
- *ID50-GPH 50 Jazz - Graphite
- *ID50-LIM 50 Jazz - Lime
- *ID50-STR 50 Jazz - Strawberry
- *ID50-TAN 50 Jazz - Tangerine



***FOB SURREY, BC ONLY**

BAGGAGE TAGS

- Tag size 3 1/2" X 2 1/16"
- Insert size 2 7/8 X 1 7/8"
- Attached locking strap.



ITEM NO.	DESCRIPTION
*ID4-YEL	25 Pcs Per Bag - Yellow

***FOB SURREY, BC ONLY**



JUMBO KEY TAGS
Made in Australia



- Supplied with 1" stainless steel ring.
- Insert card size 2 3/4" X 1 3/4".
- Tag size 3 3/4" X 2 3/16".
- Large tag offers greater key retention.
- 10 tags per bag.



ITEM NO.	DESCRIPTION
ID10-BLK	10 Jumbo Tags - Black
ID10-BLU	- Blue
ID10-GRN	- Green
ID10-ORG	- Orange
ID10-RED	- Red
ID10-YEL	- Yellow

LARGER 2" x 1 1/4" ID CARD



- High quality polypropylene key tags.
- Strong lens and locking mechanism.
- Consistency in tag colours.
- Supplied with Stainless Steel rings.
- Ideal for Office, Home, Real Estate Agents, Car Dealers & Motels.



ITEM NO.	DESCRIPTION
ID30-AC50	50 Loose Tags, Assorted Colours in Counter Top Display

Loose Tags in Poly Bag

ID30-RED	25 Red
ID30-BLU	25 Blue
ID30-GRN	25 Green
ID30-ORG	25 Orange
ID30-YEL	25 Yellow
ID30-NAT	25 Natural



GLOW-IN-THE-DARK KEY TAG
Made in Australia



- 1 1/4" X 1" card size.
- Supplied with stainless steel ring.
- Bulk bags of 50 pieces.



ITEM NO.	DESCRIPTION
ID43-NAT	50 Glow In The Dark Key Tags

KEY TAGS RACKS
Made in Australia



- High quality polypropylene key tags.
- Strong lens and locking mechanism.
- Consistency in tag colours.
- Supplied with Stainless Steel rings.
- Ideal for Office, Home, Real Estate .
- Agents, Car Dealers & Motels.
- 1-1/4" x 1" card size.



ITEM NO.	DESCRIPTION
ID9-RTL	4 Tag Key Rack With Adhesive Pads Carded For Easy Display
ID6-RTL	8 tag key rack with adhesive pads Carded For Easy Display



KEY CABINETS

- Made from .8mm steel.
- Key locking.
- Continuous number strip for fast & easy placement of numbers.
- Hook style key holders.
- Beige colour enamel paint.
- Uses modified 1611 key blanks or our TS-BLANK
- Key tags not included.



ITEM NO.	KEY CAP	HEIGHT	WIDTH	DEPTH
TS0080	20	8"	6 1/2"	3 1/4"
TS0053	54	12"	9 1/2"	2 1/2"
TS0052	90	12"	9 1/2"	3 1/4"
TS0042	140	14 1/2"	11"	3 1/4"
TS0200	200	17 3/4"	13 3/4"	3 1/4"

Key Blanks for Key Cabinet

TS-BLANK

KEY CABINETS
Combination Lock

- Made from .8mm steel.
- Changeable combination lock.
- Continuous number strip for fast & easy placement of numbers.
- Hook style key holders.
- Beige colour enamel paint.
- Key tags not included.



ITEM NO.	KEY CAP	HEIGHT	WIDTH	DEPTH
TS0087G	20	8"	6 1/2"	3 1/4"
TS0057G	36	12"	9 1/2"	3 1/4"

CASH BOXES - Lockable

- All steel construction with plastic tray.
- Lift out tray.
- Compartments have beveled sides for easy coin and bill removal.
- Supplied with fold down handle
- Locked with a cam lock with 2



ITEM NO.	NO. OF TRAY COMPARTMENTS	OUTSIDE DIMENSIONS
TS0020	3 (2 Coin, 1 Bill)	10" L x 7" W x 3 1/2" D
TS0010	5 (3 Coin, 2 Bill)	12" L x 9 1/2" W x 3 1/2" D

CASH BOXES - Lockable with Combination Lock

- All steel construction with plastic tray.
- Lift out tray.
- Compartments have beveled sides for easy coin and bill removal.
- Supplied with fold down handle.
- Locked with a cam lock with changeable combination lock.

ITEM NO.	NO. OF TRAY COMPARTMENTS	OUTSIDE DIMENSIONS
TS0027G	3 (2 Coin, 1 Bill)	10" L x 7" W x 3 1/2" D
TS0017G	5 (3 Coin, 2 Bill)	12" L x 9 1/2" W x 3 1/2" D



SHELF BRACKETS - Steel "L" Shaped

- Heavy duty steel shelf brackets with pre-drilled holes.
- Enamel painted for long lasting good appearance.
- Available in white finish.

ITEM NO.	COLOUR	DESCRIPTION
BR-001W	White	3" X 4" Heavy Duty Bracket
BR-002W	White	4" X 6" "
BR-003W	White	6" X 8" "
BR-004W	White	8" X 10" "
BR-005W	White	10" X 12" "
BR-006W	White	12" X 14" "

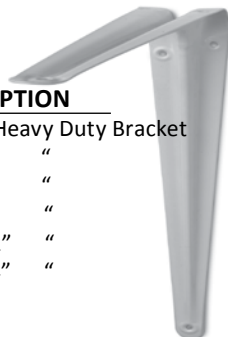

**FOB DARTMOUTH, NS ONLY*

UNDER COUNTER DEPOSITORY - For Bills

- Fastens to under counter with locking brackets.
- Dual key operation, separate key for locking bracket and bill retrieval.
- Stacks bills inside bill container.

ITEM NO.	OUTSIDE DIMENSIONS	WEIGHT
YMS-1	H 8 7/8" X W 4 5/16" X D 7 1/2"	5 lbs.



STEEL FLOOR SAFE

- Combination lock and handle locking.
- S & G key change lock.
- 1/2" Steel, spring loaded, rectangular door and 1/4" steel body.
- 12" x 12" Door opening

ITEM NO.	OUTSIDE DIMENSIONS	INSIDE DIMENSIONS	INSIDE AREA	WEIGHT
B-40	L 24 1/4", W 12 3/4", D 17 1/2"	L 23 3/4", W 12 1/4", D 14 1/8"	4109 cu. in.	128 lbs.

**FOB SURREY, BC ONLY*



ELECTRONIC HOTEL SAFE

- Idea for hotel, motel or personal use.
- 2 Motorized 20 mm locking bolts operated by 2AA batteries.
- Your personalized code is required to lock safe.
- Override code is easily programmed.
- By-pass key supplied, should electronics fail.
- Operating instructions printed on door.
- Attractive 2 tone paint.
- Carpeted floor.
- Supplied pre-drilled holes and bolt down kit.
- 5 mm door thickness and 2 mm wall thickness

ITEM NO.	OUTSIDE DIMENSIONS
EG23ZB	H 9" X W 16" X D 13-1/4"



**FOB SURREY, BC ONLY*

**FIRE RESISTANT SAFES
2 Hour Fire Rated**



- Combination and key locking
- JIS (Japanese Industrial Standard) 2 hour fire resistant rated
- Supplied with S & G key change locks
- New DS Series has removable wheels and brackets.

ITEM

NO. DESCRIPTION

SD-104	Inside	H 16 3/4", W 13 5/8", D 10 3/8"
	Outside	H 24 3/4", W 19 1/2", D 21 7/8"
	Inside Area	2453 cu. in.
	Weight	220 lbs.
	Accessories	1 tray, 2 adj. shelves
SD-105	Inside	H 20 1/4", W 13 5/8", D 13 1/3"
	Outside	H 28 1/8", W 19 1/2", D 21 7/8"
	Inside Area	3932 cu. in.
	Weight	254 lbs.
	Accessories	1 tray, 2 adj. shelves
DS-90	Inside	H 25 5/8", W 16 7/8", D 14 3/4"
	Outside	H 35 3/8", W 24", D 24 3/4"
	Inside Area	6378 cu. in.
	Weight	476 lbs.
	Accessories	1 lockable drawer, 1 adj. shelf
DS-110	Inside	H 33 1/2", W 16 7/8", D 14 3/4"
	Outside	H 43 1/4", W 24", D 24 3/4"
	Inside Area	8338 cu. in.
	Weight	573 lbs.
	Accessories	1 lockable drawer, 2 adj. shelves
DS-130	Inside	H 41 1/4", W 16 7/8", D 14 3/8"
	Outside	H 51 1/4", W 24", D 24 3/8"
	Inside Area	10006 cu. in.
	Weight	668 lbs.
	Accessories	1 lockable drawer, 3 adj. shelves
DS-133	Inside	H 41 1/4", W 22 3/8", D 18 1/4"
	Outside	H 51 1/4", W 29 1/2", D 28 1/4"
	Inside Area	16844 cu. in.
	Weight	842 lbs.
	Accessories	1 lockable drawer, 3 adj. shelves

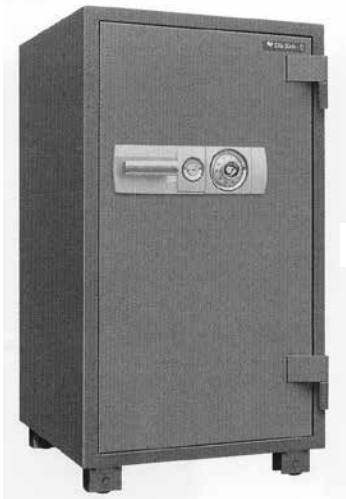

**DISCONTINUED
LIMITED QUANTITY
NO BACKORDERS**

ALL OF THE ABOVE

***FOB SURREY, BC ONLY**

HYDRAULIC JACKS

- Delivers full lifting power in upright position.
- Cylinder, housing and base precision fitted for virtually leak proof operation.
- Made of heavy-duty steel with cast iron base.
- Top of lifting cap grooved for load stability.
- Release valve allows controlled lowering.
- 2 pc. Inter-locking pump handle.
- Working temperature -20° to 45° C.



HYDRAULIC BOTTLE JACKS
Industrial Quality - Made in Spain



- Fitted with safety valve to prevent overloading allows up to 50% over rated capacity.
- The base, pressure cylinder and oil reservoir form one integral part to provide greater strength and safety.
- Will withstand tilting of load as piston does not have contact with the cylinder. Can be used in vertical or horizontal position (in horizontal position the handle and pump must be positioned below cylinder as in illustration).
- 3 pc. Zinc coated handle for easy storage.
- Repairable.
- Repair kits available.
- Carry handle on units BR-20 - BR-50.

ITEM NO.	TONS CAPACITY	MIN. HEIGHT	MAX. HEIGHT	MAX. LIFT
----------	---------------	-------------	-------------	-----------

Standard Jacks:

1002	2	7 1/8"	13 9/16"	6 5/16"
1004	4	7 5/8"	14 5/8"	4 5/8"
1006	6	8 1/2"	16 1/4"	5"
1008	8	9 1/16"	17 5/16"	5 3/4"
1012	12	9 1/16"	18 5/16"	6 1/8"
1020R	20	9 1/2"	17 7/8"	5 15/16"

Low Profile Jacks:

1012-LP	12	7 1/2"	13 13/16"	6 5/16"
1020-LP	20	7 1/2"	13 1/4"	5 3/4"



HYDRAULIC BOTTLE JACKS
Industrial Quality - Made in Spain

- Comfortable plastic handles on some models
- Swivel pump valve allows for better positioning
- 3 piece rectangular handle prevents handle roll when not in valve socket
- Can be used horizontally
- Can be repaired, repair parts available
- Heavy machined jack base

ITEM NO.	REPLACES	CAP	MIN HEIGHT	PISTON TRAVEL	MAX THREADED LIFT	OVERAL HEIGHT	CARRY HANDLE	WEIGHT lbs/kg
BR2	MG-02	2 MT	6.6" (168)	4.1" (105)	2.6" (65)	13.3" (338)	N	8 (3.6)
BR3	MG-03	3 MT	8.3" (210)	5.9" (150)	2.6" (65)	16.7" (425)	N	8.8 (4)
BR5	MG-05	5 MT	8.4" (212)	5.9" (150)	3" (71)	17.2" (437)	N	9.9 (4.5)
BR8	MG-08	8 MT	8.6" (219)	5.9" (150)	3" (71)	17.5" (444)	N	13.6 (6.2)
BR10	MG-10	10 MT	8.6" (219)	5.9" (150)	3" (71)	17.5" (444)	N	14 (6.4)
BR12	MG-12	12 MT	8.9" (226)	5.9" (150)	3" (71)	17.8" (451)	N	18.7 (8.5)
BR15	MG-15	15 MT	9" (228)	5.9" (150)	3" (71)	17.8" (453)	N	19.4 (8.8)
BR20	MG-20	20 MT	9.2" (234)	5.9" (150)	3" (71)	18.1" (459)	Y	23.3 (10.6)
BR30	MG-30	30 MT	9.5" (242)	5.9" (150)	3" (71)	18.4" (467)	Y	34 (15.5)
BR50	MG-50	50 MT	10.2" (260)	5.5" (140)	N/A	15.8" (400)	Y	59.4 (27)

Low Profile

BRS10	MGS-10	10 MT	5.2" (131)	2.4" (62)	1.18" (30)	8.8" (223)	N	11 (5)
BRS20	MGS-20	20 MT	7.5" (190)	4.2" (105)	2.2" (55)	13.8" (350)	N	21 (9.5)



SINGLE ACTING WITH SPRING RETURN SPECS



NOM FORCE TONS	ITEM NO.	STR. INS	AREA IN ²	INCHES																OIL CAP INS ³	WT. LBS.	TILT SADDLE NO.
				B	BI	C	CI	D	E	F	J	K	L	M	N	R						
5	CSRA-5D	6 7/8	1.09	10 3/4	11 5/16	17 5/8	18 1/4	19/16	1 3/16	1 1/32	2 3/4	25/32	1 1/2	19/64	5/8	15/64	7.7	5.6	BCSRA-5			
11*	CSRA-11B	2	2.46	5 11/16	6 7/16	7 5/8	8 7/16	2 11/32	1 3/4	1 17/32	2 3/4	25/32	2 1/4	1 1/16	11/16	15/64	4.9	6.4	BCSRA-11			
11*	CSRA-11C	3 15/16	2.46	7 5/8	9 7/16	11 9/16	12 3/8	2 11/32	1 49/64	1 17/32	2 3/4	25/32	2 1/4	1 1/16	11/16	15/64	9.75	8.6	BCSRA-11			
11	CSRA-11D	5 15/16	2.46	9 5/8	10 3/8	15 1/2	16 5/16	2 11/32	1 3/4	1 17/32	2 3/4	25/32	2 1/16	1 1/16	11/16	15/64	14.65	10.8	BCSRA-11			
16*	CSRA-16B	2	3.68	5 7/8	6 5/8	7 7/8	8 5/8	2 3/4	2 11/64	1 13/16	2 3/4	25/32	2 3/4	1 3/16	11/16	25/64	7.3	9.15	BCSRA-11			
16*	CSRA-16C	3 15/16	3.68	7 7/8	8 11/16	11 13/16	12 5/8	2 3/4	2 11/64	1 13/16	2 3/4	25/32	2 3/4	1 3/16	11/16	25/64	14.65	12.2	BCSRA-11			
16	CSRA-16D	5 15/16	3.68	9 15/16	10 11/16	15 7/8	16 5/8	2 3/4	2 11/64	1 13/16	2 3/4	25/32	2 3/4	1 3/16	11/16	25/64	22	15.4	BCSRA-11			
23*	CSRA-23B	2	5.12	6 1/2	7 3/8	8 1/8	9 3/8	3 11/32	2 9/16	2 1/8	2 3/4	25/32	3 5/16	1 15/16	1	25/64	10.1	15	BCSRA-23			
23*	CSRA-23C	3 15/16	5.12	8 1/2	9 7/16	12 7/8	13 5/16	3 11/32	2 9/16	2 1/8	2 3/4	25/32	3 5/16	1 15/16	1	25/64	20.2	19.7	BCSRA-23			
23	CSRA-23D	5 15/16	5.12	10 1/2	11 7/16	16 3/8	17 5/16	3 11/32	2 9/16	2 1/8	2 3/4	25/32	3 5/16	1 15/16	1	25/64	30.4	24.5	BCSRA-23			
31	CSRA-31B	2	6.84	7 5/8	8 5/8	9 5/8	10 5/8	3 15/16	2 15/16	2 1/4	2 3/4	1 7/16	3 5/16	2	1	25/64	13.4	24.2	BCSRA-23			
31	CSRA-31D	5 15/16	5.12	11 9/16	12 9/16	17 1/2	18 7/16	3 15/16	2 15/16	2 1/4	1 1/2	1 7/16	3 5/16	2	1	25/64	40.3	36.8	BCSRA-23			
55	CSRA-55B	2	6.84	6 5/8	7 5/8	8 5/8	9 5/8	5 1/64	3 15/16	3 3/16	2 3/4	25/32	5	1 25/32		3/32	23.9	36	BCSRA-55			
93	CSRA-93B	2	20.57	7 1/2	8 11/16	9 7/16	10 11/16	6 7/8	5 1/8	4 9/64	2 3/4	1 27/32	5	1 31/32			40.5	71.2	BCSRA-93			

ALL OF THE ABOVE

*FOB SURREY, BC ONLY

LIMITED QUANTITIES NO BACKORDERS



SINGLE ACTING HOLLOW PISTON CYLINDER WITH SPRING RETURN

- Carrying handles or eyes on units 44 lbs. – 88 lbs.
- Threaded mounting holes for easy application.

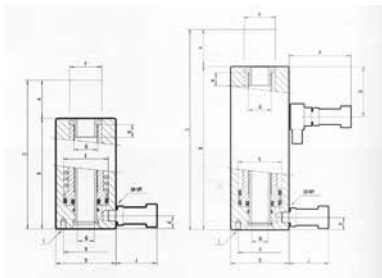

*FOB SURREY, BC ONLY

NOM FORCE TONS	ITEM NO.	STROKE INS	MAX FORCE TONS	EFFECT AREA IN ²	INCHES											OIL CAP INS ³	WT. LBS.	TILT SADDLE NO.	
					B	C	D	E	F	G	H	I	J	K	N				Q
*12	CSH-12	1 5/8	12	2.8	5 11/16	7 5/16	2 3/4	2 11/64	1 23/64	1.5	2	5/16-18 UNC	2 3/4	25/32	25/32	49/64	4.5	8.3	BRCSH-12 BMC SH-12
20	CSH-20	1 7/8	20	4.5	6 3/4	8 11/16	3 3/4	2 3/4	2	1.5	3 1/4	3/8-16 UNC	2 3/4	25/32	25/32	1 3/64	8.5	17.6	BRCSH-20 BMC SH-20
30	CSH-30	2 1/2	30	6.6	7 7/8	10 3/8	4 5/16	3 3/8	2 7/16	1.5	3 5/8	3/8-16 UNC	2 3/4	25/32	7/8	1 19/64	16.5	28.6	BRCSH-30 BMC SH-30
*60	CSH-60	3	60	13	11 7/8	17 13/16	6 1/8	4 15/16	3 45/64	1.5	5 1/8	1/2-13 UNC	2 3/4	25/32	1	2 1/64	77.2	72	BRCSH-60 BMC SH-60

DOUBLE ACTING HOLLOW PISTON CYLINDERS WITH HYDRAULIC RETURN



NOM FORCE TONS	ITEM NO.	STROKE INS	MAX FORCE TONS	EFFECT AREA IN ²	INCHES													OIL CAP INS ³	WT. LBS.	TILT SADDLE NO.
					B	C	D	E	F	G	H	I	J	K	N	O	P			
30	CDH-30	5 15/16	30	6.6	11 11/16	17 9/16	4 15/16	3 3/8	2 7/16	M46x1.5	3 5/8	3/8-16 UNC	2 3/4	25/32	7/8	1 27/32	4 7/16	39	42.2	BRCSH-30 BMCSH-30

**FOB SURREY, BC ONLY*

HYDRAULIC HAND PUMPS - Made in Spain
SINGLE ACTING, ONE SPEED

- Can be used as a portable unit in horizontal or vertical position (pump head down.)
- 10,000 PSI pressure.



ITEM NO.	PSI	EFF. OIL CAPACITY CU. INS.	OIL FLOW PER STROKE CU. INS.	INCHES											WT. LBS.	REPAIR KIT
				A	B	C	CI	D	F	G	H	I	J	L		
BM-04	10,000	24.4	.15	18.11	5	5.4	17.3	1.18	3.8	3/8 X 18 NPT	1.3	.33	1.96	1.57	9.23	RBM-04
BM-1	10,000	76.25	.15	23.23	5.23	6.1	24.0	1.18	4.09	3/8 X 18 NPT	1.3	.33	3.14	23.6	14.7	RBM-04
BM-2	10,000	122	.15	22.44	6.1	6.9	24.8	1.18	5.5	3/8 X 18 NPT	1.3	.33	3.54	23.6	26.4	RBM-04

**FOB SURREY, BC ONLY LIMITED QUANTITIES NO BACKORDERS*

HYDRAULIC CYLINDERS - Made in Spain

- Working pressure 10,000 PSI.
- All cylinders have salt bath nitrating treatment.
- Fitted with removable saddle.
- Fitted with high flow female quick coupler with dust cap.



LOW PROFILE SINGLE ACTING WITH SPRING RETURN

- Mounting holes in base.

**FOB SURREY, BC ONLY*

NOM FORCE TONS	ITEM NO.	STROKE INS	MAX FORCE TONS	EFFECT AREA IN ²	INCHES															OIL CAP INS ³	WT. LBS.
					B	BI	C	CI	D	E	F	H	I	J	K	R	S	T	U		
5	CSE-5	1/4	5	1.09	1 3/8		1 19/32		2 11/30	1 13/16	1 1/32	1 3/32	7/32	2 11/32	11/16	3/64	1 5/8	13/16	7/8	.77	1.65
11	CSE-11	7/16	11	2.46	1 3/4		2 3/16		3 1/8	1 49/64	1 7/32	1 29/64	1/4	2 3/4	15/16	3/64	2 13/64	1 1/64	1 15/16	2.8	3.85
23	CSE-23	7/16	23	5.12	2 1/8		2 9/16		3 7/8	2 9/16	2 1/8	2	23/64	2 3/4	15/16	3/64	3 1/8	1 9/16	1 7/16	5.73	7.05
31	CSE-31	15/32	31	6.84	2 11/32		2 27/32		4 17/32	2 61/64	2 1/4	2 3/64	23/64	2 3/4	15/16	3/64	3 11/16	1 13/16	1 3/4	8.2	10.5
55	CSE-55	5/8	55	12.17	2 27/32		3 15/32		5 25/32	3 15/16	3 3/16	2 3/4	7/16	2 3/4	15/16	3/64	4 7/8	2 7/16	2 15/16	19.4	20.7



LIGHT DUTY CASTERS

- Solid rubber wheel.
- Plain bearing.
- Single ball bearing raceway on swivel models.



Wheel Dia	Tread Width	Axle Dia	Overall Height	Mounting Bolt Dia	Finish	Load Cap
1 1/2"	1 1/16"	3/16"	2 1/8"	3/16"	Black	60 lbs.
2"	1"	1/4"	2 5/8"	1/4"	Zinc	80 lbs.
2 1/2"	1 1/16"	5/16"	3 1/4"	1/4"	Zinc	100 lbs.

ITEM NO.	DESCRIPTION	MOUNTING PLATE		
SYR-15068	1 1/2" Rigid	1 13/16"	x	1 1/2"
SYS-15068	1 1/2" Swivel	1 13/16"	x	1 1/2"
SYFR-20100	2" Rigid	2 11/16"	x	1 9/16"
SYFS-20100	2" Swivel	2 5/8"	x	1 7/8"
SYFR-25112	2 1/2" Rigid	4 7/16"	x	2 5/16"
SYFS-25112	2 1/2" Swivel	3 7/8"	x	2 3/4"

GENERAL DUTY CASTERS

- Solid rubber wheel.
- Sintered iron bearing.
- Single ball bearing raceway on swivel models.

Wheel Dia	Tread Width	Axle Dia	Overall Height	Mounting Bolt Dia.	Finish	Load Cap
3"	1 1/4"	3/8"	3 13/16"	5/16"	Zinc	175 lbs.
4"	1 1/2"	3/8"	5"	3/8"	Zinc	220 lbs.

ITEM NO.	DESCRIPTION	MOUNTING PLATE		
SYFR-30125	3" Rigid	4 15/16"	x	2 1/2"
SYFS-30125	3" Swivel	4 1/8"	x	3 1/8"
SYFB-30125	3" Swivel With Side Brake	4 1/8"	x	3 1/8"
SYFR-40150	4" Rigid	6 1/4"	x	3 1/4"
SYFS-40150	4" Swivel	5" x 4"		
SYFB-40150	4" Swivel With Side Brake	5" x 4"		



MEDIUM HEAVY DUTY CASTERS

- Hard rubber tire on cast iron wheel.
- Grease-able roller bearings and grease-able double raceway ball bearings.
- Heavy 3/16" steel mounting plate and legs.



Wheel Dia	Tread Width	Axle Dia	Overall Height	Mounting Bolt Dia	Finish	Load Cap
5"	2"	1/2"	6 1/2"	3/8"	Zinc	450 lbs.
6"	2"	1/2"	7 5/8"	3/8"	Zinc	500 lbs.

ITEM NO.	DESCRIPTION	MOUNTING PLATE	
SYMR-50200	5" Rigid	4 1/2"	x 4"
SYMS-50200	5" Swivel	4 1/2"	x 4"
SYMR-60200	6" Rigid	4 1/2"	x 4"
SYMS-60200	6" Swivel	4 1/2"	x 4"

JOB BOX CASTER SET

ITEM NO. JBSCS-1

Contains 2 each : SYMR-50200, 5" rigid casters
SYMS-50200, 5" swivel casters

**FOB DARTMOUTH, NS ONLY*

FUNNELS Plastic-Multi-Purpose 2 IN 1

- Can be used as a transmission funnel or flex spout detaches to be used as regular funnel.
- Supplied with built in 1" screen-filter.
- Convenient plastic handle to hold funnel securely.



ITEM NO.	CAP.	TOP DIA.	SPOUT DIA. O.D.	OVERALL LENGTH
TT1-238	900 ml	5 3/4"	11/16" Funnel Only 1/2" Flex Spout	7 1/2" Funnel Only 15" W/Flex Spout

FUNNELS - Plastic 4 Piece Set

- Can be used for Home, Auto or Business.
- All funnels have convenient tabs for hanging.
- 4 pce. set consisting of: 2", 3", 4" and 4 1/2" dia. funnel.
- Poly bagged with header card.

ITEM NO.	CAP.	TOP DIA.	SPOUT DIA O.D.	OVERALL LENGTH
TT1-239	50 ml	2"	5/16"	3"
	100 ml	3"	3/8"	4 1/2"
	200 ml	4"	7/16"	5 1/2"
	250 ml	4 1/2"	9/16"	6"



**FUNNELS - GALVANIZED STEEL
Made in U.S.A.**



- Strong interlocked soldered seams.
- Supplied with 70 mesh brass strainer screen.

ITEM NO.	DESCRIPTION	CAP.	FUNNEL SIZE	SPOUT TYPE	SPOUT DIA.
SK491	General Purpose.	1 Qt.	6"	Centre	5/8"
SK495	Transmission. 16" Flex Spout.	1 Qt.	6"	Centre	7/16"
SK590	Heavy Duty With Wired Top Extra Deep & Fluted Bottom To Prevent Swirling	8 Qt.	9"	Centre	1"
SK620	Heavy Duty With Wired Top	6 Qt.	10"	Side	1"
SK690	Heavy Duty With Wired Top Extra Deep & Fluted Bottom To Prevent Swirling	12 Qt.	11"	Centre	1"
SKSM	Small Screen				
SKLG	Large Screen				



**FUNNELS, MEASURING CONTAINERS AND OILERS
Made in Canada by CLUTHE PRODUCTS**

- Made of flexible, durable polyethylene.
- Ideal for oils, acids, adhesives, etc.
- Spark, dent, and rust proof.
- Funnels are made with built-in hang up tab.
- All funnels are natural colour.
- Made to resist colder temperatures.

ITEM NO.	DESCRIPTION	DIMENSIONS				
		A	B	C	D	E
C30030	Funnel	3"	4 1/2"	2 1/2"	3/8"	2 1/8"
C30050	Funnel	5"	6"	2 1/4"	5/8"	2 1/8"

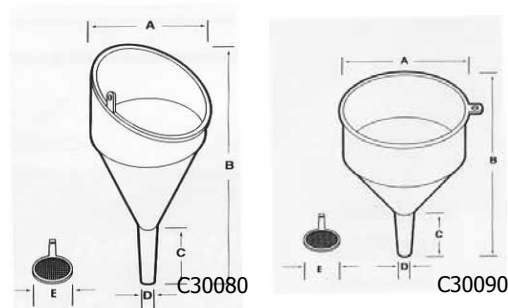

AUTOMOTIVE AND INDUSTRIAL FUNNELS WITH 100 MESH FILTER

C30080	Tapered Rim 120 oz	8"	10"	5 1/2"	7/8"	2 1/8"
C30090	Funnel 144 oz	9"	10 1/2"	2 1/4"	5/8"	2 1/8"

ANTI-SPLASH FUNNELS WITH 100 MESH FILTER

C30150	Anti-Splash 24 oz.	5 3/4"	6 1/2"	2 1/4"	5/8"	2 1/8"
C30190	Anti-Splash 144 oz	9"	10 1/2"	3 1/2"	3 1/2"	2 1/8"

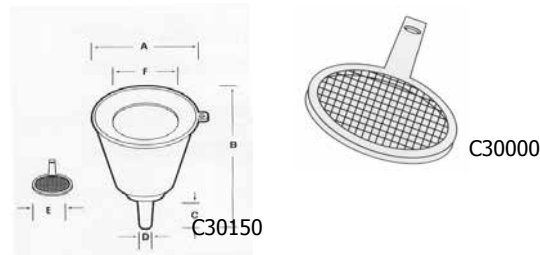

FILTERS FOR FUNNELS - 100 MESH

C30000	100 Filters	Bulk	Gold Mesh
--------	-------------	------	-----------



CLUTHE SCOOPS

- Ideal for measuring dry materials.
- Made of flexible durable polyethylene.

ITEM NO.	DESCRIPTION	CAP.	COLOUR	DIMENSIONS				
				A	B	C	D	E
C33110	Scoop	52 oz.	Natural	4"	3 1/4"	7"	5 1/2"	2 1/8"
C33140*	Scoop	104 oz.	Natural	5 1/2"	2 1/2"	10"	6"	6 1/4"

*C33140 is calibrated in U.S., Metric and Imperial Measures.

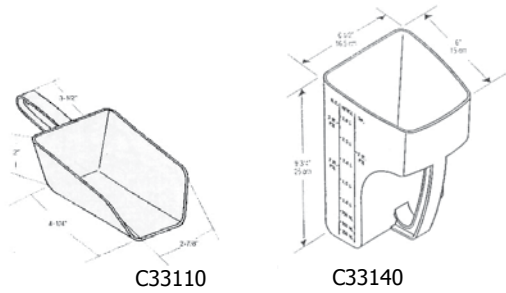

CLUTHE MEASURING CONTAINERS

ITEM NO.	DESCRIPTION	CAP	COLOUR
C34020	Measuring Container	87 oz.	Natural
C34040	Measuring Container	155 oz.	Natural
C34046	Measuring Container With Pouring Spout	155 oz.	Natural



C34020
C34040



C34046

GREASE GUNS Lever & Pistol Grip Type

- Supplied with 7" detachable metal spout.
- 3 way filling.
- 11" body accepts 14 oz. cartridges or can be filled by hand.



ITEM NO.	DESCRIPTION
G-4805	Lever Type Grease Gun
A-480N	Pistol Grip Type Gun
G-4805FLEX	12" Rayon Braided Rubber Hose
A-401-18	18" Nylon hose w/coupler
G-4805CPL	Npt 3 Jaw Coupler Blister Packed



PUMP OILERS Metal (Perfetta Type)



- Supplied with rigid PVC flex detachable spouts.
- Steel pump mechanism.
- Supplied in cello bag with header card.

ITEM NO.	CAPACITY
R-101	10 oz. (300cc)
R-103	24 oz. (700cc)
R-120	33 oz. (1,000cc)

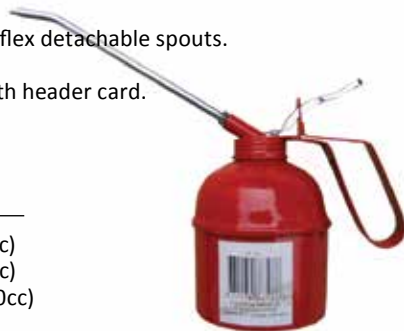

OIL SUCTION GUN - 500 CC Capacity

- Chrome plated to resist corrosion.
- 11 1/2" suction hose supplied.
- Rubber sealed piston assures maximum suction.
- Comfortable T handle operation.

ITEM NO.	DESCRIPTION
A-501	500 cc Capacity Suction Gun



REINFORCED BRAIDED P.V.C. FLEXIBLE SPOUTS

ITEM NO.	DESCRIPTION
Flexible Spout for All "R" Series Oilers:	
R-103FLEX	6 1/2"
Rigid Replacement Metal Spout for "R" Series Oilers:	
R-101M	5 1/2"



PUMP - Submersible With Float Switch

- 1/6 HP Motor 115V/60Hz.
- Max 1400 GPH Flow Rate 26.3 Head.
- Low 1/8" pick up.
- Thermal plastic construction.
- Removable screw for cleaning.
- 1" water outlet with 3/4" hose adaptor.
- 10' grounded electrical cord.
- uL approved.



ITEM NO.	DESCRIPTION
Q1DP-400C	Submersible Pump w/Float Switch

POLYPRO Hand Operated Rotary Pump

- Glass filled polypropylene construction.
- Suitable for most petroleum products *except gasoline*, water, waterbased chemicals, alcohol and mild alkaline products.
- 360° rotation.
- Movable outlet spout.
- Pumps 6 GPM @ 70 revolutions.
- Supplied with 47" polypropylene suction tube and 2" NPT bung adapter.
- 1" OD barbed spout end.
- 46" polyethylene delivery hose included.
- Parts available.
- Packed in display box.



ITEM NO.	DESCRIPTION
RP-90P	Polypropylene Rotary Pump
RP-90P-16	Bung Adaptor with Lock
RP-90P-20	46" Replacement Hose For RP-90P Pump

DIAMOND HAND OPERATED ROTARY PUMP

- Simple installation and operation, as well as durable.
- Steel vanes (note - not suitable for chemicals which are liable to corrode metals).
- Parts available.
- Complete with 8 ft. vinyl hose and steel pipe.



ITEM NO.	DESCRIPTION
KS-25	Pumping Capacity: 18 Litres Per Minute
KS-25-21	8' Replacement Vinyl Hose For Above

** ALL PARTS AVAILABLE **

LEVER BARREL PUMP

- Zinc plated for long life.
- Brass piston ring makes this pump suitable for use with lubricants, solvents, and other non-corrosive liquids.
- Spout is threaded for garden hose fittings.
- Suction tube extends 18" to 36".
- Suitable for 1 1/2" and 2" NPT bungs.
- Dispenses approx. 300cc per stroke.
- PVC coated handle.



ITEM NO.	DESCRIPTION
A-490	Lever Barrel Pump, Boxed

PLASTIC SYPHON PUMP

- Lightweight and economical, corrosion resistant.
- Made of heavy polyethylene vinyl chloride.
- Suitable for use all sizes of drums with 2" bungs.
- Used to transfer liquids such as oil, kerosene, fuel.
- Dispenses 15 litres/min.
- 33 1/2" suction pipe, 46" discharge hose.



ITEM NO.	DESCRIPTION
CK-9	Plastic Syphon Pump

LEVER PAIL PUMP - For Oils

- For motor oil, gear oil and ATF.
- Fits full open head pails through 6 1/2 gal.
- Includes pump, pail cover, and 4 ft. of clear vinyl hose with curved discharge nozzle.
- Delivers approx. 1 gal./60 strokes.



ITEM NO.	DESCRIPTION
A-492	Hand Oil Pump

CHAIN BLOCKS

- Safe reliable, with minimum maintenance.
- High efficiency and small hand pull.
- Triple spur gears.
- Lightweight.

ITEM NO.	CAP	LIFT	CHAIN DIA.	HEAD ROOM REQUIRED
100	1 Ton	8 ft.	15/64"	11'
200	2 Ton	10 ft.	5/16"	14'



ROPE HOIST

- 65 ft. nylon rope.
- 7 to 1 ratio.
- Steel blocks with nylon rollers.
- Double grip safety hooks.
- Max. pulling capacity, 1,000 lbs.
- Ideal for hunters, campers, boaters, etc.

ITEM NO	DESCRIPTION
PH-2C	1,000 lbs



LEVER CHAIN RATCHET PULLER Mini

- Steel housing.
- Supplied with spring loaded safety latches.
- Lightweight for ease of carrying.
- Uses 4 mm load chain.
- Standard 1 metre lift.
- Rubber hand grip for comfortable grip.
- Up, down and free lever functions.
- Friction brake.
- Replacement parts available.

ITEM NO	DESCRIPTION	WEIGHT
A619-025	1/4 Ton Capacity	1.8 kg



RATCHET CABLE PULLERS

- Economical reliable puller.
- Ideal for camping, farming, boating, landscaping, fencing, etc.



ITEM NO.	DESCRIPTION
PI-401	1 Ton Cap., 10 ft. Cable. 2 Hooks and Safety Latch Included Single Gear
PHP-30	2 Ton Cap., 10 ft. Cable, 3 Hooks and Safety Latch Included Double Gear
PHP-40	4 Ton Cap., 10 ft. Cable, 3 Hooks and Safety Latch Included Double Gear

LEVER CHAIN RATCHET PULLERS Heavy Duty

- Steel housing.
- Safe, reliable and durable in use.
- Excellent performance and minimum maintenance.
- Uses Grade 8 chain.
- Cast safety latch.
- Light weight and portable in size.
- Light hand pull and high efficiency.
- Max. lift 1.5m (59").
- Friction brake.
- Replacement parts available.

ITEM NO	DESCRIPTION
A619-075	3/4 Ton Capacity
A619-150	1 1/2 Ton Capacity
A619-300	3 Ton Capacity



RATCHET ROPE PULLER

- Grips rope and pulls through
- Suitable for 10.5 mm (7/16") rope
- Supplied with polyester rope
- 3 hook design
- Double gear design
- Comfort grip handle
- Supplied with 6 metres of rope

ITEM NO.	DESCRIPTION
HPR-302-2	1 Ton Ratchet Rope Puller



WIRE ROPE - Galvanized Aircraft Cable

- Galvanized Steel.
- Supplied on spools.
- Manufactured to DIN Standards.

APPROX. SPOOL DIMENSIONS

ITEM NO.	CABLE DIA.	CNST.	BREAKING LOAD (in lbs.)	SPOOL LENGTH (in feet)	APPROX. GROSS WT./ROLL (in lbs.)	BORE	SPOOL DIA. (in inches)	OVERALL WIDTH
AC-116	1/16"	7 x 7	480	500	4.4	1	6	4 3/4
AC-332	3/32"	7 x 7	920	500	8.8	1	6	5
AC-18	1/8"	7 x 7	1,700	500	13.6	1	7	5 3/4
AC-18-2	1/8"	7 x 19	2,000	500	13.1	1	7 1/4	5 3/4
AC-532	5/32"	7 x 19	2,800	250	12.1	1	6	7
AC-316	3/16"	7 x 19	4,200	250	16.5	1	7 3/4	5 3/4
AC-14	1/4"	7 x 19	7,000	250	27.7	1	8 3/4	6 1/4
AC-516	5/16"	7 x 19	9,800	250	43.4	2 1/4	10	10
AC-38	3/8"	7 x 19	14,400	250	61.16	2 1/4	12	8 3/4



Supplied in Full Spool Length Only

WIRE ROPE CLIPS

- Galvanized malleable iron.

ITEM NO.	SIZE	ITEM NO.	SIZE
705-01	1/8"	705-06	1/2"
705-02	3/16"	705-07	5/8"
705-03	1/4"	705-08	3/4"
705-04	5/16"	705-09	7/8"
705-05	3/8"	705-10	1"



CABLE SLEEVES - OVAL ALUMINUM

- Packaged and sold 10/bag.

ITEM NO.	USE WITH CABLE DIA.
ACB-116	1/16"
ACB-332	3/32"
ACB-18	1/8"
ACB-532	5/32"
ACB-316	3/16"
ACB-14	1/4"
ACB-516	5/16"
ACB-38	3/8"



GALVANIZED WIRE ROPE THIMBLES

- Electro-Galvanized.

ITEM NO.	SIZE
700-1-8	1/8"
700-3-16	3/16"
700-1-4	1/4"
700-5-16	5/16"
700-3-8	3/8"



PULLEY YOLK ASSEMBLY - FIXED EYE

- Complete with safety latch hook.
- Plated finish.

ITEM NO.	DESCRIPTION	DIA.
UP-2000	Pulley Yoke Assembly Non Swivel	2"



CABLE STOPS - ALUMINUM CONSTRUCTION

- Packaged and sold 10/bag.

ITEM NO.	USE WITH CABLE DIA.
ACA-116	1/16"
ACA-332	3/32"
ACA-18	1/8"
ACA-532	5/32"
ACA-316	3/16"
ACA-14	1/4"
ACA-516	5/16"
ACA-38	3/8"



EYE SLIP HOOK

ITEM NO.	SIZE	WEIGHT
*3046	5/16" w/Safety Latch	1.0 lbs.

***FOB DARTMOUTH, NS ONLY**



PULLEY SINGLE SHEAVES - SWIVEL EYE

- Malleable iron body, cast iron sheaves.

ITEM NO.	SHEAVE DIA.	MAX ROPE DIA.	EYE DIA.
0173-075	3/4"	1/4"	5/16"
0173-125	1 1/4"	5/16"	9/16"
0173-200	2"	7/16"	5/8"



PULLEY SINGLE SHEAVES - FIXED EYE

- Malleable iron body, cast iron sheaves.

ITEM NO.	SHEAVE DIA.	MAX ROPE DIA.	EYE DIA.
0174-075	3/4"	5/32"	3/16"
0174-125	1 1/4"	1/4"	3/8"
0174-200	2"	7/16"	7/16"



PULLEY SINGLE SHEAVES - SWIVEL EYE Stainless Steel

ITEM NO.	SHEAVE DIA.	USEFUL GROOVE	RECOM WORKING LOAD
S314-125	1 1/4"	3/8"	1,600 lbs
S314-200	2"	5/8"	3,500 lbs

PULLEY DOUBLE SHEAVES - SWIVEL E Stainless Steel

ITEM NO.	SHEAVE DIA.	USEFUL GROOVE	RECOMM WORKING LOAD
S315-125	1 1/4"	3/8"	1,600 lbs.
S315-200	2"	5/8"	3,500 lbs.



WOOD ROPE BLOCK - Single

- Hook, sheave and straps, hot dipped galvanized.
- Supplied with stainless safety latch on loose hook.

ITEM NO.	DESCRIPTION	ROPE SIZE	SHELL LENGTH
*SWB-3	Single Sheave	3/8"	3"
*SWB-4	Single Sheave	1/2"	4"
*SWB-5	Single Sheave	5/8"	5"
*SWB-6	Single Sheave	3/4"	6"

**FOB DARTMOUTH, NS ONLY*



WOOD ROPE BLOCK - Double

ITEM NO.	DESCRIPTION	ROPE SIZE	SHELL LENGTH
*DWB-3	Double Sheave	3/8"	3"
*DWB-4	Double Sheave	1/2"	4"
*DWB-5	Double Sheave	5/8"	5"
*DWB-6	Double Sheave	3/4"	6"

**FOB DARTMOUTH, NS ONLY*



PULLEY SINGLE SHEAVES WITH HANGER Swivel Eye - Stainless Steel

ITEM NO.	SHEAVE DIAMETER	USEFUL GROOVE	RECOMM. WORKING LOAD
S314A-125	1 1/4"	3/8"	1,600 lbs.
S314A-200	2"	5/8"	3,500 lbs.



PULLEY DOUBLE SHEAVES WITH HANGER Swivel Eye - Stainless Steel

ITEM NO.	SHEAVE DIAMETER	USEFUL GROOVE	RECOMM. WORKING LOAD
S315A-125	1 1/4"	3/8"	1,600 lbs.
S315A-200	2"	5/8"	3,500 lbs.



SNATCH BLOCKS

- Supplied with smooth long lasting needle bearing sheave.
- Spring loaded safety latch on swivel hook.
- Moveable side plate allows easy installation of wire rope.

ITEM NO.	SIZE	RECOMM. ROPE SIZE	FACTORY RECOMM. SWL
130-3	3"	3/8"	0.5
130-4	4"	7/16"	1
130-5	5"	1/2"	1.5
130-6	6"	5/8"	2
130-8	8"	3/4"	4



PILLOW BLOCKS

- Cast iron.
- Supplied with 1/8" NPT grease nipple.
- Self-aligning.



ITEM NO.	SHAFT DIAMETER	ITEM NO.	SHAFT DIAMETER
UCP201-08	1/2"	UCP207-21	1 5/16"
UCP202-10	5/8"	UCP207-22	1 3/8"
UCP204-12	3/4"	UCP207-23	1 7/16"
UCP205-14	7/8"	UCP208-24	1 1/2"
UCP205-16	1"	UCP209-26	1 5/8"
UCP206-18	1 1/8"	UCP209-28	1 3/4"
UCP206-19	1 3/16"	UCP210-31	1 15/16"
UCP207-20	1 1/4"	UCP211-32	2"

YARDING BLOCKS

- Industrial quality.
- Open ball bearings with grease nipples.
- Swivel attachments available.

ITEM NO.	SIZE	MAX. WIRE ROPE SIZE	FACTORY RECOMM. BREAKING SWL LOAD	BREAK-ING LOAD
135-3	3"	5/16"	1.5 Ton	6
135-4	4"	3/8"	3 Ton	12
135-5	5"	7/16"	4.5 Ton	18
135-6	6"	9/16"	6 Ton	24
135-8	8"	3/4"	8 Ton	32



BEARING UNITS

- For pillow blocks, 4 bolt flange, 2 bolt oval flange.
- Cylindrical outside diameter.

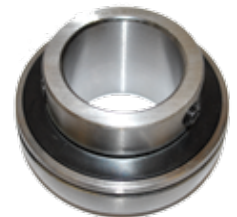

Set Screw Locking Type:

ITEM NO.	SHAFT DIAMETER	ITEM NO.	SHAFT DIAMETER
UC204-12	3/4"	UC207-22	1 3/8"
UC205-14	7/8"	UC207-23	1 7/16"
UC205-16	1"	UC208-24	1 1/2"
UC206-18	1 1/8"	UC209-26	1 5/8"
UC206-19	1 3/16"	UC209-28	1 3/4"
UC207-20	1 1/4"	UC210-31	1 15/16"
UC207-21	1 5/16"	UC211-32	2"

SHEAVES - CAST IRON

- Bronze sleeve bearing.
- Grease fitting equipped.

ITEM NO.	DIA.	BORE DIA.	APPROX. ROPE SIZE
CIS-03	3"	1/2"	5/16"
CIS-04	4"	5/8"	3/8"
CIS-05	5"	3/4"	1/2"
CIS-06	6"	11/8"	5/8"
CIS-08	8"	1 1/4"	7/8"



Eccentric Collar Locking Type:

ITEM NO.	SHAFT DIAMETER
ELS204-12	3/4"
ELS205-14	7/8"
ELS205-16	1"
ELS207-20	1 1/4"



FLANGES - 2 Bolt Oval Housing

- Cast iron housing.
- Supplied with 1/8" NPT grease nipple.

ITEM NO.	SUITABLE FOR BEARING NUMBER
----------	-----------------------------

FL203	UC201, UC202
FL204	UC203, 203-11, 204, 204-12
FL205	UC205, 205-13, 205-14, 205-15, 205-16
FL206	UC206, 206-17, 206-18, 206-19
FL207	UC207, 207-20, 207-21, 207-22, 207-23
FL208	UC208, 208-24, 208-25
FL209	UC209, 209-26, 209-27, 209-28
FL210	UC210, 210-29, 210-30, 210-31, 210-32
FL211	UC211, 211-32, 211-33, 211-34, 211-35
FL212	UC212, 212-36, 212-38, 212-39



FLANGES - 4 Bolt Square Housing

- Cast iron housing.
- Supplied with 1/8" NPT grease nipple.

ITEM NO.	SUITABLE FOR BEARING NUMBER
----------	-----------------------------

F203	UC201, UC202.
F204	UC203, 203-11, 204, 204-12
F205	UC205, 205-13, 205-14, 205-15, 205-16
F206	UC206, 206-17, 206-18, 206-19
F207	UC207, 207-20, 207-21, 207-22, 207-33
F208	UC208, 208-24, 208-25
F209	UC209, 209-26, 209-27, 209-28
F210	UC210, 210-29, 210-30, 210-31, 210-32
F211	UC211, 211-32, 211-33, 211-34, 211-35
F212	UC212, 212-36, 212-38, 212-39



TAPERED BEARING SETS

ITEM NO.	CONE/CUP
----------	----------

BEA-01	LM11749/LM11710
BEA-02	LM11949/LM11910
BEA-03	M12649/M12610
BEA-04	LM44649/LM44610
BEA-05	LM48548/LM48510
BEA-06	LM67048/LM67010
BEA-07	M201047-S/M201011 w/ring
BEA-08	L45449/L45410
BEA-09	BS226095 w/ring (RSN 1578V)
BEA-11	JL69349/JL69310
BEA-12	LM12749/LM12710
BEA-13	L68149/L68110
BEA-14	L44643/L44610
BEA-16	LM12749/LM12711
BEA-17	L68149/L68111
BEA-35A	LM501349/LM501310



TAPERED BEARING SETS

ITEM NO.	DESCRIPTION	SHAFT DIA. mm	OUTER DIA. mm
----------	-------------	---------------	---------------

30203A	Metric	17	40
--------	--------	----	----



DEEP GROOVE BALL BEARINGS

- With double seals.

ITEM NO.	INNER DIA. mm	OUTER DIA. mm	WIDTH mm
----------	---------------	---------------	----------

6000-2RS	10	26	8
6001-2RS	12	28	8
6002-2RS	15	32	9
6003-2RS	17	35	10
6004-2RS	20	42	12
6005-2RS	25	47	12
6006-2RS	30	55	13
6007-2RS	35	62	14
6008-2RS	40	68	15
6009-2RS	45	75	16
6010-2RS	50	80	16
6200-2RS	10	30	9
6201-2RS	12	32	10
6202-2RS	15	35	11
6203-2RS	17	40	12
6204-2RS	20	47	14
6205-2RS	25	52	15
6206-2RS	30	62	16
6207-2RS	35	72	17
6301-2RS	12	37	12
6302-2RS	15	42	13
6303-2RS	17	47	14
6304-2RS	20	47	14
6305-2RS	25	62	17
6306-2RS	30	72	19
6310-2RS	50	110	27
6909-2RS	45	68	12
608-2RS	8	22	7
626-2RS	6	19	6
627-2RS	7	22	7
629-2RS	9	26	8
635-2RS	5	19	6





TRAILER KITS - Bagged With Header Card

ITEM NO.	DESCRIPTION
*GH 2001 (For 1" Axle)	Consists Of: 2 L44610 Bearing Cup 2 L44643 Cone 1 12124 Seal 1 Cotter Pin 1 Package Bearing Grease
*GH 2002 (For 1-1/16" Axle)	Consists Of: 2 L44610 Bearing Cup 2 L44649 Cone 1 12124 Seal 1 Cotter Pin 1 Package Bearing Grease



***FOB DARTMOUTH, NS ONLY**

HITCH PINS - Folding Handle

- Supplied with linch pin.
- Supplied with chain fastened to linch pin.
- Zinc plated.



ITEM NO.	DIA.	USABLE LENGTH
5101-250	3/8"	3" (no chain with pin)
5102-280	1/2"	3 1/2" (with chain & pin)
5103-281	5/8"	4 1/4" (with chain & pin)
5104-282	5/8"	6 1/4" (with chain & pin)
5105-283	3/4"	4 1/4" (with chain & pin)
5106-284	3/4"	6 1/4" (with chain & pin)
5107-285	7/8"	6 1/4" (with chain & pin)
5108-286	1"	6 1/4" (with chain & pin)
5109-287	1 1/8"	6 1/4" (with chain & pin)
5110-288	1 1/4"	7 1/2" (with chain & pin)

BENT HITCH PINS

- Zinc plated.
- Clip included.
- Carbon steel.



ITEM NO.	LIST DIA.	USEABLE LENGTH
5201-270	1/2"	3"
5202-271	5/8"	3"

HITCH ACCESSORIES

HITCH PINS

- One piece drop forged pin.
- Vinyl dipped handle.
- Hardened & tempered high tensile steel.
- Includes clip.



ITEM NO.	DIA.	USEABLE LENGTH	HAIR PIN NO.
5002-251	1/2"	3 5/8"	5704-307
5003-252	5/8"	4"	5706-305
5004-256	5/8"	5 1/2"	5706-305
5005-253	3/4"	4"	5706-305
5006-257	3/4"	6 1/2"	5706-305
5007-254	7/8"	4 1/2"	5706-305
5008-258	7/8"	6 1/2"	5706-305
5009-255	1"	4 1/2"	5706-305
5010-259	1"	7 1/2"	5706-305
5011-260	1 1/8"	8 1/2"	5706-305
5012-261	1 1/4"	8 1/2"	5708-304
5013-262	1 1/2"	8 1/2"	-----

QUICK PINS - Curved Spring Type

- Zinc dichromate finish.

LIST ITEM NO.	DIA.	USEABLE LENGTH
5301-460	1/4"	1 5/8"
5302-461	1/4"	1 1/2"
5303-463	5/16"	1 3/8"
5304-464	5/16"	1 3/4"
5305-466	3/8"	1 3/4"



QUICK PINS - Square Spring Type

- Zinc dichromate finish.

ITEM NO.	DIA.	USEABLE LENGTH
5401-462	1/4"	2 1/4"
5402-465	5/16"	2 1/4"
5403-467	3/8"	2 1/4"
5404-468	3/8"	2 3/4"



SAFETY PINS

- Zinc plated.
- Alternative to using hair pins.

ITEM NO.	DIA.	USEABLE LENGTH
5501-470	1/8"	1 3/4"
5502-472	3/16"	3 1/2"
5503-474	1/4"	5 1/4"



LINCH PINS

- Zinc dichromate finish.

ITEM NO.	DIA.	USEABLE LENGTH
5601-450	3/16"	1 1/4"
5602-451	1/4"	1 1/2"
5603-452	5/16"	1 3/8"
5604-453	3/8"	1 3/8"
5605-454	7/16"	1 5/16"
5606-455	7/16"	1 1/2"



HITCH PIN CLIPS

- Zinc dichromate finish.
- Packed and pried 100 pcs per bag.

ITEM NO.	DIA.	OVERALL LENGTH
5701-300	1/16"	1 3/8"
5702-301	3/32"	1 5/8"
5703-303	3/32"	2 1/4"
5704-307	1/8"	1 7/8"
5705-306	1/8"	2 1/2"
5706-305	5/32"	3 1/8"
5707-302	3/16"	3 3/8"
5708-304	3/16"	3 3/4"
5709-308	1/4"	4 1/4"



HAIR PINS

- Zinc dichromate finish.
- Packed and pried 100 pcs per bag.

ITEM NO.	DIA.	OVERALL LENGTH
*5710-311	1/8"	2 1/16"
*5711-312	3/16"	2 3/4"



***FOB SURREY, BC ONLY**

S HOOKS

- Grey zinc.
- Packed 100 per bag.
- Packed and pried 100 pcs per bag.

ITEM NO.	MATERIAL DIAMETER	OPENING SIZE
5801-230	0.093	3/32"
5802-232	0.105	7/64"
5803-234	0.120	1/8"
5804-235	0.162	5/32"
5805-236	0.148	9/64"
5806-238	0.250	1/4"
5807-239	0.188	3/16"



WELDED STEEL RINGS

- Grey zinc.

ITEM NO.	MATERIAL DIAMETER	OUTSIDE DIAMETER	INSIDE DIA.
5901-410	3/16"	1"	5/8"
5902-411	1/4"	1 1/2"	1"
5903-412	5/16"	2"	1 3/8"



QUICK LINKS - Plated Steel

- Zinc plated steel.
- No tools required, can be tightened with fingers.
- Ideal for quick connection of chain, cable & wire rope.

ITEM NO.	SIZE	SWL
601	3.5mm (1/8")	220 lbs.
602	5mm (3/16")	660 lbs.
603	6mm (1/4")	880 lbs.
604	8mm (5/16")	1760 lbs.
605	9mm (3/8")	2200 lbs.
606	10mm (7/16")	2700 lbs.
607	12mm (1/2")	3300 lbs.



QUICK LINKS - Stainless Steel

- Made from 316 stainless steel.
- Ideal for quick connection of chain and wire rope.
- Suitable in situations where moisture is a problem.

ITEM NO.	SIZE	SWL
602-SS	5mm (3/16")	
603-SS	6mm (1/4")	
604-SS	8mm (5/16")	
605-SS	9mm (3/8")	
607-SS	12mm (1/2")	



LAP LINKS

- Zinc plated steel.

ITEM NO.	SIZE	INSIDE LENGTH
660-1	1/8"	3/4"
660-2	3/16"	1"
660-3	7/32"	1 1/4"
660-4	5/16"	1 1/2"
660-5	3/8"	2"
660-6	1/2"	2 1/2"



LINK LOCKS - Made in Sweden

- Galvanized steel.
- Heavy duty repair or joining link.
- Ideal for tire chains, logging trucks.

ITEM NO.	SIZE	BREAKING LOAD
461-1	1/4"	3700 lbs.
461-2	5/16"	6000 lbs.
461-3	3/8"	12000 lbs.
461-4	1/2"	15000 lbs.



HAMMERLOCKS

- A-337 Grade 80 material
- Used for attaching chain to master links and eye type hooks or for installing a new branch of body to old slings.
- Made from larger stock than the chain they are used with, they provide greater interlink wearing surface
- Load pin and stud can be assemble quickly and easily with just a hammer.

ITEM NO.	CHAIN SIZE	WORKING LOAD LIMIT
*25221	1/4"	3,500
*25221A	5/16"	5,400
*25222	3/8"	7,100
*25223	1/2"	12,000
*25224	5/8"	18,100
*25225	3/4"	28,300
*25226	7/8"	34,200



***FOB DARTMOUTH, NS ONLY**

COLD SHUTS

- Electro-galvanized.
- C1015 Steel.

ITEM NO.	SIZE	INSIDE WIDTH (CLOSED)	INSIDE LENGTH (CLOSED)
*706-01	3/16"	11/32"	15/16"
*706-02	1/4"	3/8"	1 3/16"
*706-03	5/16"	7/16"	1 3/8"
*706-04	3/8"	5/8"	1 1/2"
*706-05	7/16"	5/8"	1 5/8"
*706-06	1/2"	3/4"	1 5/8"



***FOB SURREY, BC ONLY**

ANCHOR SHACKLES

- Galvanized steel.
- Screw collar pin.
- Pin and body same size.

ITEM NO.	WWL	WIDTH CHAIN SIZE	PIN DIA.	WIDTH BETWEEN EYES	INSIDE LENGTH (CLOSED)
701-01	1/3 T	3/16"	1/4"	3/8"	5/16"
701-02	1/2 T	1/4"	5/16"	15/32"	1 1/8"
701-03	3/4 T	5/16"	3/8"	17/32"	1 1/4"
701-04	1 T	3/8"	7/16"	21/32"	1 7/16"
701-05	1 1/2 T	7/16"	1/2"	23/32"	1 11/16"
701-06	2 T	1/2"	5/8"	13/16"	1 15/16"
701-07	3 1/4 T	5/8"	3/4"	1 1/16"	2 1/2"
701-08	4 3/4 T	3/4"	7/8"	1 1/4"	2 7/8"
701-09	6 1/2 T	7/8"	1"	1 7/16"	3 1/4"
701-10	8 1/2 T	1"	1 1/8"	1 11/16"	3 1/4"



ANCHOR SHACKLES

- Zinc plated steel.
- Screw collar pin.

ITEM NO.	CHAIN SIZE	PIN DIA.	BETWEEN EYES	INSIDE LENGTH
701-03Z	5/16"	3/8"	17/32"	1 3/16"
701-04Z	3/8"	7/16"	5/8"	1 7/16"
701-06Z	1/2"	5/8"	13/16"	1 7/8"
701-07Z	5/8"	3/4"	1 1/16"	2 3/8"



ANCHOR SHACKLES - Stainless Steel

- Made from 316 stainless steel.
- Screw collar pin.

ITEM NO.	CHAIN SIZE	PIN DIA.	BETWEEN EYES	INSIDE LENGTH
481-06	1/4"	1/4"	1/2"	1 1/16"
481-08	5/16"	5/16"	11/16"	1 7/16"
481-10	3/8"	3/8"	13/16"	1 3/4"
481-12	1/2"	1/2"	1"	2 3/32"
481-16	5/8"	5/8"	1 3/16"	2 7/8"
481-19	3/4"	3/4"	1 7/16"	3 5/16"



JAW END SWIVELS

- Forged, quenched and tempered
- Hot dip galvanized finish
- Ultimate load is 5 times working load limit

ITEM NO.	LIST DESCRIPTION	SAFE WORKING LOAD LIMIT
*707-03J	3/8" (Material & Pin Size)	2250 lbs.
*707-04J	1/2" (Material & Pin Size)	3600 lbs.
*707-05J	5/8" (Material & Pin Size)	5200 lbs.
*707-06J	3/4" (Material & Pin Size)	7200 lbs.
*707-07J	1" (Material & Pin Size)	12500 lbs.

**FOB DARTMOUTH, NS ONLY*



D SHACKLES

- Zinc plated.

ITEM NO.	SIZE
*360-09	3/8"
*360-12	1/2"

**FOB DARTMOUTH, NS ONLY*



TRAWLING SHACKLES

- Mild steel.
- Self coloured (black).
- Threaded pin.

ITEM NO.	DESCRIPTION	SIZE
*701TS-1	Trawling Shackles	10mm
701TS-2	Trawling Shackles	12mm

**FOB DARTMOUTH, NS ONLY*



TURNBUCKLES - Eye and Eye

- Galvanized forged steel.

ITEM NO.	SIZE MM	IN.	BODY LENGTH	EYE SIZE	EYE WALL THICKNESS
*704-02EE	8 mm	(5/16")	4 3/4"	7/16"	1/4"
*704-03EE	10 mm	(3/8")	5 1/2"	5/8"	5/16"
*704-04EE	12 mm	(1/2")	7 1/2"	3/4"	3/8"
*704-05EE	16 mm	(5/8")	10"	7/8"	7/16"

**FOB SURREY, BC ONLY*



TURNBUCKLES - Hook and Eye

- Galvanized forged steel.

ITEM NO.	SIZE MM	IN.	SAFE WORKING LOAD (SWL)	BREAKING POINT
704-01	6	(1/4")	220 lbs.	2xSWL
704-02	8	(5/16")	440 lbs.	2xSWL
704-03	10	(3/8")	660 lbs.	2xSWL
704-04	12	(1/2")	1100 lbs.	2xSWL
704-05	16	(5/8")	2200 lbs.	2xSWL
704-06	20	(3/4")	3300 lbs.	2xSWL
704-07	22	(7/8")	4840 lbs.	2xSWL
704-08	24	(1")	6600 lbs.	2xSWL



EYE BOLTS - With Shoulder

- Hot dipped galvanized.
- Welded ring through eye.
- Supplied with zinc plated washer and nut.

ITEM NO.	DESCRIPTION	SHANK DIAMETER AND LENGTH SIZE
EB-06050	Eyebolt	1/4" x 2"
EB-06100	Eyebolt	1/4" x 4"
EB-08062	Eyebolt	5/16" x 2 1/2"
EB-08112	Eyebolt	5/16" x 4 1/2"
EB-10062	Eyebolt	3/8" x 2 1/2"
EB-10112	Eyebolt	3/8" x 4 1/2"
EB-10150	Eyebolt	3/8" x 6"
EB-10200	Eyebolt	3/8" x 8"
EB-12087	Eyebolt	1/2" x 3 1/2"
EB-12150	Eyebolt	1/2" x 6"
EB-12200	Eyebolt	1/2" x 8"

*ALL OF THE ABOVE
FOB DARTMOUTH, NS ONLY



RINGBOLTS - With Shoulder

- Hot dipped galvanized.
- Supplied with zinc plated washer and nut.

ITEM NO.	DESCRIPTION	SHANK DIAMETER AND LENGTH
RB-10112	Ringbolts	3/8" x 4 1/2"
RB-10150	Ringbolts	3/8" x 6"
RB-12150	Ringbolts	1/2" x 6"
RB-12200	Ringbolts	1/2" x 8"

*ALL OF THE ABOVE
FOB DARTMOUTH, NS ONLY



SPRING HOOKS - Plated Steel

- Spring loaded interlocking safety snaps.
- Ideal for small boat, mooring, motor safety line, camping & golf course nets.

ITEM NO.	SIZE	
	MM	IN.
2450-1	5mm	(3/16")
2450-2	6mm	(1/4")
2450-3	8mm	(5/16")
2450-4	10mm	(3/8")
2450-5	11mm	(7/16")
2450-6	12mm	(1/2")



SPRING HOOKS - Stainless Steel

- Made from 316 stainless steel.
- Stainless steel spring and pin.
- Suitable for marine applications.

ITEM NO.	SIZE		LENGTH
	MM	IN.	
2450-1SS	5mm	(3/16")	50mm (2")
2450-2SS	6mm	(1/4")	60mm (2 3/8")
2450-3SS	8mm	(5/16")	80mm (3 1/8")
2450-4SS	10mm	(3/8")	100mm (4")
2450-5SS	11mm	(7/16")	110mm (4 1/8")



SWIVELS - Stainless Steel - Eye N Eye

- 316 Stainless Steel.

ITEM NO.	DESCRIPTION
*1290-06	6mm (1/4")
*1290-08	8mm (5/16")
*1290-10	10mm (3/8")
*1290-12	12mm (1/2")

***FOB DARTMOUTH, NS ONLY**



SWIVELS - Double End

- Hot dipped galvanized.

ITEM NO.	DESCRIPTION	MATERIAL SIZE
*707-02	Double end swivel	1/4"
*707-03	Double end swivel	3/8"
*707-04	Double end swivel	1/2"
*707-05	Double end swivel	5/8"
*707-06	Double end swivel	3/4"
*707-08	Double end swivel	1"

***FOB DARTMOUTH, NS ONLY**



EYE GRAB HOOKS

- Forged carbon steel.
- Electro-galvanized.
- High test.
- Heat treated.

ITEM NO.	SIZE	WORKING LOAD LIMIT	ULTIMATE LOAD
702E-01	1/4"	2,600 lbs.	4 x WWL
702E-02	5/16"	3,900 lbs.	4 x WWL
702E-03	3/8"	5,400 lbs.	4 x WWL
702E-04	1/2"	9,200 lbs.	4 x WWL



EYE SLIP HOOKS

- Forged carbon steel.
- Electro-galvanized.
- High test.
- Heat treated.

ITEM NO.	SIZE	WORKING LOAD LIMIT	ULTIMATE LOAD LIMIT
703E-01	1/4"	2,600 lbs.	4 x WWL
703E-02	5/16"	3,900 lbs.	4 x WWL
703E-03	3/8"	5,400 lbs.	4 x WWL
703E-04	1/2"	9,200 lbs.	4 x WWL



CLEVIS GRAB HOOKS

- Galvanized.
- High test.
- Forged steel.

ITEM NO.	SIZE	SAFE WORKING LOAD (SWL)	BREAKING POINT
702-01	1/4"	2,600 lbs.	4 x SWL
702-02	5/16"	3,900 lbs.	4 x SWL
702-03	3/8"	5,400 lbs.	4 x SWL
*702-04	1/2"	8,500 lbs.	4 x SWL

***FOB DARTMOUTH, NS ONLY**



CLEVIS SLIP HOOKS

- High test.
- Forged steel.

ITEM NO.	SIZE	SAFE WORKING LOAD (SWL)	BREAKING POINT
703-01	1/4"	1,950 lbs.	4 x SWL
703-02	5/16"	2,875 lbs.	4 x SWL
703-03	3/8"	4,000 lbs.	4 x SWL
*703-04	1/2"	6,500 lbs.	4 x SWL

***FOB DARTMOUTH, NS ONLY**



MINI LOAD BINDER

- Rack pattern.
- Safe working load 250 lbs.
- Take up 3".



ITEM NO.	CHAIN SIZE	WEIGHT CAPACITY
1-270	3/16" - 1/4"	250 lbs.

WINCH BAR - Combination Type

- Chrome plated.
- Knurled handle.
- 32" length overall.
- Supplied with load binder socket end.



ITEM NO.	DESCRIPTION
TW-BAR	Combination Winch Bar

LOAD BINDER

- Standard pattern.
- Safe working load, 1,250 lbs.
- Handle of cast steel.
- Hook of carbon steel drop forged.
- Take up 2 3/4".

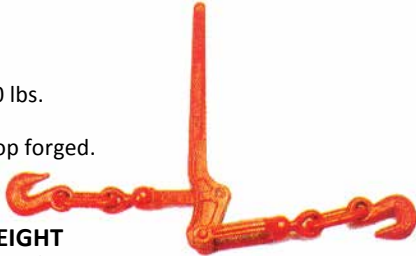

ITEM NO.	CHAIN SIZE	WEIGHT CAPACITY
2-76	1/4"-5/16"	1250 lbs.

SNAP-HOOKS

- Forged steel.
- Load rated 5,000 lbs.
- Size 1" hole x 5 3/8" overall length.

ITEM NO.	SIZE
3047	Zinc Plated
3047-2L	Zinc Plated But W/Double Safety Latch
3047-G	Hot Dipped Galvanized with Stainless Steel Spring and Pin



3047



3047-2L



3047-G

LOAD BINDER

- Standard pattern.
- Heat treated drop forged steel.
- Ball & socket swivel joints at hook assemblies permit a straight line pull.
- Extra solid construction at leverage point prevents spreading.
- Safe working load, 5,400 lbs.
- Take up 4 1/2".



ITEM NO.	CHAIN SIZE	WEIGHT CAPACITY
3-305	5/16" - 3/8"	5,400 lbs.

LOAD BINDERS - Ratchet Type

- Forged Steel.
- Orange painted.



ITEM NO.	CHAIN SIZE	WLL	MBS	TAKE UP
3-305RAT	5/16"-3/8"	5,400 lbs.	19,000 lbs.	8"

SWIVEL EYE LEASH SNAPS - Solid Brass

ITEM NO.	EYE SIZE	OVERALL LENGTH
B5025-38	3/8"	3"
B5025-50	1/2"	3"



SWIVEL EYE BOLT SNAPS - Solid Brass

ITEM NO.	EYE SIZE	OVERALL LENGTH
B225-58	5/8"	3 1/8"
B225-75	3/4"	3 1/8"



FIXED EYE SNAPS - Solid Brass

ITEM NO.	EYE NO.	EYE SIZE	OVERALL LENGTH
B249-037	0	3/8"	2"
B249-062	1	5/8"	2 7/8"
B249-068	2	1 1/16"	3 1/4"
B249-075	3	3/4"	3 3/4"



SWIVEL EYE BOLT SNAPS - Die Cast Zinc Alloy

- Nickel plated.

ITEM NO.	EYE SIZE	OVERALL LENGTH
201-075	3/4"	3 1/8"
201-100	1"	3 1/8"



SWIVEL EYE SNAPS - Solid Brass

ITEM NO.	EYE NO.	EYE SIZE	OVERALL LENGTH
B251-58	1	5/8"	3 1/8"
B251-75	2	3/4"	3 3/4"
B251-78	3	7/8"	4 5/8"



SWIVEL TRIGGER SNAPS - Die Cast Zinc Alloy

- Nickel plated.

ITEM NO.	EYE SIZE	OVERALL LENGTH
5013-050	1/2"	2 3/8"
5013-075	3/4"	2 1/2"



SWIVEL - Brass

ITEM NO.	EYE SIZE
B018-58	5/8"
B018-100	1"



SWIVEL SNAPS - Steel

- Nickel plated.

ITEM NO.	SNAP SIZE	OVERALL LENGTH
734A-125	1 1/4"	2 1/4"
734A-162	1 5/8"	2 5/8"
734A-200	2"	3"



BULL SNAP - Swivel Eye

- Malleable iron nickel plated.

ITEM NO.	EYE SIZE	LENGTH
3142-087	7/8"	4"
3142-100	1"	5"



DOUBLE END CHAIN SNAPS - Solid Brass

ITEM NO.	OVERALL LENGTH	OPENING SIZE
B161	3 1/2"	5/16"
B162	3 3/4"	7/16"
B163	4 3/4"	1/2"



PANIC SNAP - Die Cast Zinc Alloy

- Nickel plated.

ITEM NO.	HOOK SIZE	EYE SIZE	EYE TYPE	LENGTH
1052-100	5/8"	1"	Swivel	4 1/2"





CHAIN

- Grade 30 proof coil
- Packed in square sided plastic pails
- Available in bright zinc or hot dipped galvanized finish
- Short link type

ITEM NO.	SIZE	FINISH	LENGTH PER PAIL	DESCRIPTION	WEIGHT PER PAIL IN LBS
G30ZP-1-8	1/8"	Bright Zinc	500'	1/8" Bright Zinc Proof Coil	89
G30ZP-3-16	3/16"	Bright Zinc	250'	3/16" Bright Zinc Proof Coil	99
G30ZP-1-4	1/4"	Bright Zinc	141'	1/4" Bright Zinc Proof Coil	91
G30ZP-5-16	5/16"	Bright Zinc	92'	5/16" Bright Zinc Proof Coil	88
G30ZP-3-8	3/8"	Bright Zinc	63'	3/8" Bright Zinc Proof Coil	83
G30HD-1-8	1/8"	Hot Galvanized	500'	1/8" Hot Dipped Galvanized Proof Coil	89
G30HD-3-16	3/16"	Hot Galvanized	250'	3/16" Hot Dipped Galvanized Proof Coil	99
G30HD-1-4	1/4"	Hot Galvanized	141'	1/4" Hot Dipped Galvanized Proof Coil	91
G30HD-5-16	5/16"	Hot Galvanized	92'	5/16" Hot Dipped Galvanized Proof Coil	88
G30HD-3-8	3/8"	Hot Galvanized	63'	3/8" Hot Dipped Galvanized Proof Coil	83



**FOB DARTMOUTH, NS ONLY*

CHAIN - Galvanized - (Light Duty)

Short Link. A3. Should not be used for lifting.

ITEM NO.	DESCRIPTION	FT. PER DRUM
BZC-1	1/8"	2,000
BZC-2	3/16"	1,500
BZC-3	1/4"	800
BZC-4	5/16"	550



**FOB DARTMOUTH, NS ONLY*

CHAIN - Hot Dipped, Galvanized

Short Link. Grade 30.

ITEM NO.	DESCRIPTION	FT./ DRUM
G30-1	3/16"	1,500
G30-2	1/4"	800
G30-3	5/16"	550
G30-4	3/8"	400
G30-5	1/2"	200



**FOB DARTMOUTH, NS ONLY*

CHAIN - Grade 70 (Transport Chain)

For trucking, load binding, security chains. Yellow zinc coated. Marked with grade 70 symbol every three feet. Not recommended for overhead lifting.

ITEM NO.	GRADE	SIZE	FINISH	WLL	FT./ DRUM
G70-3	70	5/16"	Yellow Zinc	2,800 lbs.	550
G70-4	70	3/8"	Yellow Zinc	2,800 lbs.	400
G70-5-16	70	5/16"	Yellow Zinc	2,800 lbs.	92'
G70-3-8	70	3/8"	Yellow Zinc	2,800 lbs.	63'



**FOB DARTMOUTH, NS ONLY*

SPRING, FASTENER AND GREASE NIPPLE ASSORTMENTS

- Supplied in multiple compartment plastic box.

ITEM NO.	DESCRIPTION
KTSR-300	300 pc. Snap Ring Assortment
KTSA-200	200 pc. Spring Assortment
KTHP-150	150 pc. Hair Pin Assortment
KTRR-285	285 pc. Retaining Ring Assortment
KTCPA-555	555 pc. Cotter Pin Assortment
KTEC-300	300 pc. E-Clip Assortment
KTRP-315	315 pc. Split Pin Assortment
KTGN-110M	110 pc. Grease Nipple Set Metric
KTGN-110	110 pc. Grease Nipple Set SAE



KTSR-300



KTSA-200



KTHP-150



KTRR-285



KTCPA-555



KTEC-300



KTRP-315



KTGN-110M
KTGN-110

RUBBER O RING KITS - In Plastic Box

- Buna-N-BG 715 (Nitrile 70 Shore)- SAE J200.
- Material Buna-N passed ASTM oil #1 & #3 laboratory test.



ITEM NO.	DESCRIPTION
KT-D2000	407 Pcs., 1/8" - 2" Inside Diameter, 1/16" - 1/8" Section
KT-D2000M	419 Pcs., 3mm - 50mm Inside Diameter, 1.5mm - 3.5mm Section

SET SCREW, CAP SCREW AND CLEVIS PIN ASSORTMENT

- Supplied in multiple compartment plastic box.

ITEM NO.	DESCRIPTION
TE5-0435	106 Pce. Allen Cap Screw Assortment 3 each - 3/8"-16 x 1", 3/8"-16 x 1 1/2", 5 each - 5/16"-18 x 1", 5/16"-18 x 1 1/2", 10 each - 1/4"-20 x 1/2, 1/4"-20 x 1", 20 each - #10-24 x 1", 25 each - #8-32 x 1/2", #10-24 x 1/2"
TE5-0436	200 Pce. Allen Set Screw Assortment 15 each - 10 x 1/4", 10 x 5/16", 1/4" x 1/4", 20 each - 1/4" x 3/8", 30 each - 5/16" x 1/2", 3/8" x 3/8", 3/8" x 1/2"
TE5-0437	56 Pce. Universal Clevis Pin & Hair Pin Assortment (Plated Finish) 3 each - 1/2" x 2", 5 each - 5/16" x 2", 7/16" x 2 1/2" 15 each - 3/8" x 2", Clevis Pins 3 each - 9/64" x 1 3/4" Hair Pins 5 each - 3/32" x 1 3/16" Hair Pins 20 each - 7/64" x 1 5/8" Hair Pins





CABLE TIES

- Standard cable ties made from U.L. approved nylon 6/6.
- Normal service temperature range - 40° to 85°C.
- Flammability rating UL 94V-2.
- Made to comply with MIL-SPEC M 20693B.
- Tensile strength meet or exceed MIL-S 23190E Standard.
- Cable ties up to and including 21.3" are packed in 100 per bag.

ITEM NO.	OVERALL LENGTH	WIDTH	BUNDLE DIA	TENSILE STRENGTH
----------	----------------	-------	------------	------------------

White Nylon

CV-120L	4.7" (120mm)	4.8mm	29mm	50 lbs. (22 kg)
CV-190	7.3" (186mm)	4.8mm	51mm	50 lbs. (22 kg)
CV-280	11.3" (286mm)	4.8mm	83mm	50 lbs. (22 kg)
CV-280L	11.5" (292mm)	7.6mm	82mm	120 lbs. (54 kg)
CV-368	14 1/2" (365mm)	4.8mm	109mm	50 lbs. (22 kg)
CV-380	14 1/2" (365mm)	7.6mm	108mm	120 lbs. (54 kg)
CV-450	17.7" (450mm)	7.6mm	133mm	120 lbs. (54 kg)
CV-540	21.3" (540mm)	7.6mm	162mm	120 lbs. (54 kg)
CV-762	30.3" (770mm)	8.80mm	233mm	175 lbs. (79 kg)

Black Nylon

CV-120LB	4.7" (120mm)	4.8mm	29mm	50 lbs. (22 kg)
CV-190B	7.3" (188mm)	4.8mm	51mm	50 lbs. (22 kg)
CV-280B	11.3" (286mm)	4.8mm	83mm	50 lbs. (22 kg)
CV-280LB	11.3" (292mm)	7.6mm	82mm	120 lbs. (54 kg)
CV-368B	14 1/2" (368mm)	4.8mm	109mm	50 lbs.
CV-380B	14 1/2" (368mm)	7.6mm	108mm	120 lbs.
CV-450B	17.7" (450mm)	7.6mm	133mm	120 lbs. (54 kg)
CV-540B	21.3" (540mm)	7.6mm	162mm	120 lbs. (54 kg)



WHISK BROOM – Synthetic Bristles

- 8 1/2" overall length.
- 4" width.
- Handle has handy hole for hanging up.

ITEM NO.	DESCRIPTION
XP-4500R	Synthetic Whisk Broom



ANGLE BROOM

- PVC bristles are washable.
- Metal handle has a hang-up cap.

ITEM NO.	DESCRIPTION
FR458	Angle Broom PVC Bristles W/48" Metal Handle



CORN BROOMS

- 3 row stitching
- Molded steel band binding
- Heavy duty handle 42" x 1 1/8"

ITEM NO.	DESCRIPTION
FR1034	Heavy Duty Corn Exterior W/Stiff Cane Center For Heavy Sweep Loads
FR1036	Heavy Duty Corn Exterior W/Yucca Fibre Center For Long Wear



CORN WHISK BROOM

- 12 1/2" Overall length.
- 3 Strand construction
- Metal cap with hang ring.
- UPC coded.

ITEM NO.	DESCRIPTION
MB-0370 (Previously FR417)	Corn Whisk Broom



PUSH BROOMS - All Purpose - Heads Only

- 2 Threaded handle holes.
- For smooth surfaces.
- Requires handle XP-1015, XP-3101.
- Pre-drilled for 16" brace.

ITEM NO.	DESCRIPTION
MB-3518B (Previously FR0818H)	18" Wood Block W/Flagged Nylon Bristle 2 Threaded Handle Holes Ideal For Fine-Medium Dirt
MB-3524B (Previously FR0824H)	24" Wood Block W/Flagged Nylon Bristle Pre-Drilled For Brace 2 Handle Holes For Even Wear
MB-2124M (Previously FR0624HP)	24" Wood Block W/Tampico Fibre Pre-Drilled For Brace 2 Threaded Handle Holes
MB-2136 (Previously FR0636)	36" Wood Block W/3" Tampico Fibre Pre-Drilled For Brace



PUSH BROOMS - Stiff Palmyra Centre

- Natural fibre.
- Palmyra centre.
- Medium/coarse sweeping.
- Requires handle XP-1015, XP-3101.

ITEM NO.	DESCRIPTION
FR6218	18" Block W/Synthetic Polymer Bristles 2 Threaded Handle Holes
FR6224 (Previously FR1124H)	24" Wood Block 2 Threaded Handle Holes Pre-Drilled For Brace



STIFF SWEEP FLOOR BRUSHES

- Most popular heavy-duty maintenance broom.
- Filled with PVC bristle.
- Head only.
- See our selection of wood and metal handles.

ITEM NO.	DESCRIPTION
*MB-3018M (Previously FB104-18)	18"
*MB-3024M (Previously FB104-24)	24"
*MB-3030 (Previously FB104-30)	30"

**FOB DARTMOUTH, NS ONLY*



PUSH BROOM - Coarse Stiff Head Only

- 24" Wood block with fluorescent orange polypropylene bristles.
- 2 Threaded handle holes.
- Pre-drilled for brace.
- Requires handle XP-1015, XP-3101

ITEM NO.	DESCRIPTION
XP-628202	24" Wood Block



PUSH BROOM - Head Only

- Medium bristle.
- Flagged polypropylene butter bristle with stiff inner bristle.
- Threaded handle holes.
- Drilled for brace.

ITEM NO.	DESCRIPTION
XP-628204	24" Wood Block



PUSH BROOMS - Medium To Heavy Sweeping

- PVC ends with poly fibre middle to create a U shape design to trap dirt.
- 3" trim.
- Requires handle XP-1015, XP-3101.

ITEM NO.	DESCRIPTION
MB-2838 (Previously FR1618H)	18" Wood Block W/PVC-Poly Fibre Bristles 2 Handle Holes
MB-2839 (Previously FR1624H)	24" Wood Block W/PVC Poly Bristles 2 Threaded Handle Holes Pre-Drilled For Brace



PUSH BROOMS - Medium Duty

- PVC bristles.
- Oil and chemical resistant.
- Requires handle XP-1015, XP-3101.

ITEM NO.	DESCRIPTION
MB-3050 (Previously FR2824HP)	24" Wood Block W/PVC Bristles 2 Threaded Handle Holes Pre-Drilled For Brace
MB-3051 (Previously FR2836)	36" Wood Block W/PVC Bristles Pre-Drilled For Brace



MEDIUM / FINE SWEEP FLOOR BRUSHES

- Filled with algil centre for medium sized particles.
- Outside border filled with flagged grey PVC for fine dust and debris.
- Head only.
- See our selection of wood and metal handles.

ITEM NO.	DESCRIPTION
*MB-2618GH (Previously FB106-18)	18"
*MB-2624GH (Previously FB106-24)	24"
*MB-2630GH (Previously FB106-30)	30"
*MB-2636GH (Previously FB106-36)	36"

***FOB DARTMOUTH, NS ONLY**



VERY FINE SWEEP FLOOR BRUSHES

- Filled with flagged grey PVC.
- Removes very fine dust.
- Head only.
- See our selection of wood and metal handles.

ITEM NO.	DESCRIPTION
*MB-3518GH (Previously FB107-18)	18"
*MB-3524GH (Previously FB107-24)	24"
*MB-3530GH (Previously FB107-30)	30"



***FOB DARTMOUTH, NS ONLY**

UNIVERSAL BRACE FOR FLOOR BRUSHES

- Ensures maximum handle life
- Rod style
- Recommended for 60" + length handles, weighs 0.6 lb.

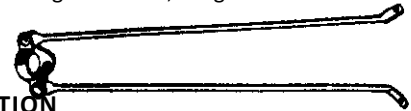

ITEM NO.	DESCRIPTION
*MB-0108	Broom handle brace

***FOB DARTMOUTH, NS ONLY**

BRACE - Heavy Duty Steel

- Recommended for use with brooms over 24".
- Galvanized bolts & wing nuts used to fasten brace to handle.

ITEM NO.	DESCRIPTION
MB-108F (Previously FR87-1)	Steel Broom Brace



BROOM - Floor Broom

- Bristles are split tipped to pick up fine dust and dirt (attracts like a magnet).
- Broom has a 11" sweep surface with a 3" trim.
- The handle is equipped with an end cap and hang-up hole.
- PVC Fibre

ITEM NO.	DESCRIPTION
*FR453	Soft Sweep Broom

***FOB DARTMOUTH, NS ONLY**

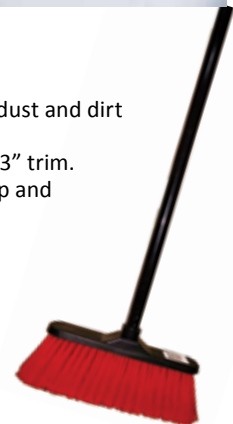

STREET AND STABLE BROOM

- Extra long polypropylene fibres
- For use in garages, streets, decks and driveways
- Head only.
- See our selection of wood and metal handles.

ITEM NO.	DESCRIPTION
----------	-------------

*MB-5014
(Previously FB109S-14)

**FOB DARTMOUTH, NS ONLY*



STABLE BROOM

- Heavy Durastran bristles.
- Ideal for street, cement, or driveway sweeping.
- 4" trim.
- Requires handle #XP-1018.

ITEM NO.	DESCRIPTION
----------	-------------

MB-5016 16" Wood Block Stable Broom
(Previously FR5716) Drilled W/2 Tapered Holes



ROOF & TAR BRUSH - Handle Included

- Ideal for application of all types of roof coatings.
- 3" trim 5" x 2" wood block.
- Threaded handle hole for 48" handle supplied.

ITEM NO.	DESCRIPTION
----------	-------------

MB-3604-9047 Roof & Tar Brush,
(Previously FR523) Tampico Fibre



ROUND WINDOW/BOAT BRUSH

- 4 1/2" poly foam block round brush
- Uses threaded handle.
- Flow-through design.

ITEM NO.	DESCRIPTION
----------	-------------

FR653 Tampico Bristles



ROUND WINDOW/BOAT BRUSHES - Head Only

- Top and side handle receiver.

ITEM NO.	DESCRIPTION
----------	-------------

XP-0601 Polypropylene (stiff) Bristle
4 1/2" Round Brush
Flow Through

XP-0603 Tetalon (soft) Bristle
4 1/2" Round Brush



RECTANGULAR WASH BRUSHES Head Only

- Plastic block.
- Polystyrene bristle.
- Has water flow through feature.

ITEM NO.	DESCRIPTION
----------	-------------

FR670 Soft Rectangular Wash Brush 8" Green



RECTANGULAR WASH BRUSH - Head Only

- Foam block.
- Flagged Tetalon bristle.
- Has water flow through feature.

ITEM NO.	DESCRIPTION
----------	-------------

XP-5608A Soft 10" Rectangular Wash Brush



DECK/POOL BRUSH - Head Only

- Extra stiff.
- Bi-level feature allows for better cleaning of corners and sides.
- Flow through head.

ITEM NO.	DESCRIPTION
----------	-------------

FR5317 Deck/Pool Brush 10"
(Previously FR690)



COUNTER BRUSH

- Heavy duty counter duster.
- The lacquered wooden handle is filled with PVC fiber, 3" trim.
- Handle has a hang up hole.

ITEM NO.	DESCRIPTION
FR85 (Previously FR176)	13" Counter Brush

UTILITY BRUSH - Rig Brush

- 20" Handle
- PVC Bristle

ITEM NO.	DESCRIPTION
*FR838 (Previously FR199)	Utility RIG Brush



**FOB SURREY, BC ONLY*

INDUSTRIAL YACHT MOP WITH HANDLE

- Made from cotton yarn.
- Industrial 16 oz. yacht mop w/54" wood handle for heavy-duty jobs.
- Comes complete w/hang-up cap.

ITEM NO.	DESCRIPTION
MB-6817 (Previously FR116)	Industrial Yacht Mop

COTTON MOP REFILL - Contractor

- Made from cotton yarn.
- 24 oz. Cotton flat mop refill.
- Yarn is held securely w/1" mesh headband.
- Yarn is 4 ply for extra strength.
- Use with our # FR4754 handle.

ITEM NO.	DESCRIPTION
FR1624 (Previously FR624)	Cotton Mop Refill

POINTED WOOD SCRUB BRUSH

- Stiff union fiber.
- 9 1/8" x 2 1/2" wood block.
- Pointed ends to fit into corners.
- Strong chemicals do not affect the stiff tampico bristles.

ITEM NO.	DESCRIPTION
MB-0077 (Previously FR157)	Wood Scrub Brush

DUST PANS - Plastic

- This premium heavy-duty polypropylene dustpan has a 6 1/2" deep pan w/beveled hold lip.
- The two resting feet on the underside holds the tray at the correct angle.

ITEM NO.	DESCRIPTION
FR4K	12" Heavy-duty Polypropylene Dust Pan

DUST PAN - Metal

- Heavy-duty 12" metal dust pan.
- Rolled steel handle has a convenient hang-up hole.

ITEM NO.	DESCRIPTION
MB-0180 (Previously FR6)	12" Metal Dustpan

HANDLES - Metal

ITEM NO.	DESCRIPTION
FR4754 (Previously FR7454)	Frame and Handle For Mop #FR1624



EXTENSION POLE - Telescopic

- Aluminum construction with foam hand grips.
- Flow through feature.
- Threaded end to accept brush.
- Expandable from 35" to 78".

ITEM NO.	DESCRIPTION
XP-3958	Flow-through Extension Pole



HANDLES - BROOM & MOP - Wood

- Made of "Bamwood" Bamboo with glued wood filler.
- Very strong and flexible.

ITEM NO.	DESCRIPTION
XP-1013	60" X 15/16" Wood Broom Handle Metal Thread End Type

XP-1015	54" x 15/16" Wood Broom Handle, Wood Thread
---------	---

XP-1009 (Previously XP-1018)	54" x 1 1/8" Wood Broom Handle, Tapered End
---------------------------------	---



HANDLES - BROOM, MOP - Metal

- Heavy-duty hollow metal handles.
- Handles have nylon ends and rubber handgrips.
- 1" Diameter Metal Handles.

ITEM NO.	DESCRIPTION
XP-3114 (Previously XP-3101)	60" Metal Handle With Threaded Tip



FLOOR SQUEEGEE - Rubber Blade (Head Only)

- Zinc plated frame
- Handle socket designed for tapered handle
- Can be used with our hand item no. XP-1009

ITEM NO.	DESCRIPTION
XP-3305	24" Straight Squeegee Head
XP-3306	24" Curved Squeegee Head
XP-3319	36" Straight Squeegee Head



FLOOR SQUEEGEE - Foam Rubber (Head Only)

- Cleans light to medium debris
- Best on smooth, semi-smooth surfaces
- Blade can be reversed for longer life
- Foam blade is quick drying

ITEM NO.	DESCRIPTION
FR25330	30" Foam Floor Squeegee



**FOB DARTMOUTH, NS ONLY*

WORK LIGHT - 10,000 Lumen LED

- 100W LED assembly saves power, lasts over 30,000 hours.
- More resistant to shock, generates much less heat than comparable halogen lights.
- Bright 5000K daylight colour temperature.
- 176 individual SMD LEDs.
- IP65 rated enclosure, suitable for outdoor use.
- 120V AC operation.
- Replacement switch available.
- Colour retail box.



ITEM NO.	DESCRIPTION
LWLP10000	Floodlight LED 5000K, 100W/10K Lumens, 1.8 m Cord

TRIPOD WORK LIGHT - 2 x 10,000 Lumen LED

- 2 X 100W LED assembly saves power, lasts over 30,000 hours.
- More resistant to shock, generates much less heat than comparable halogen lights.
- Bright 5000K daylight colour temperature.
- 176 individual SMD LEDs.
- Tripod height with lights over 6 1/2' / 2 m.
- Each light with its own switch and convenient tilt and swivel knobs.
- IP65 rated enclosure, suitable for outdoor use.
- 120V AC operation.
- Replacement switch available.
- Colour retail box.

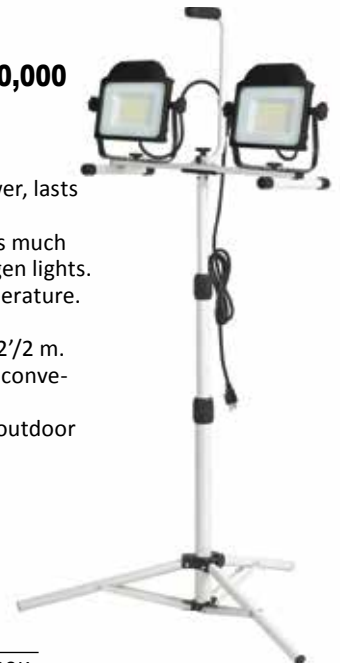

ITEM NO.	DESCRIPTION
LWLT20000	Floodlight LED 5000K, 2 X 100W/10K Lumens, 3.6 m Cord



STRING LIGHT SET - Job Site

- Standard lamp sockets spaced 10' apart.
- 12/3 SJTW cable.
- Heavy duty coated steel lamp cages.
- End-to-end connectable (max 1500W total) with dust cover on end.
- CSA S1088 certified.

ITEM NO.	DESCRIPTION
EC123300-06	50' Light String Construction
EC123300-11	100' Light String Construction

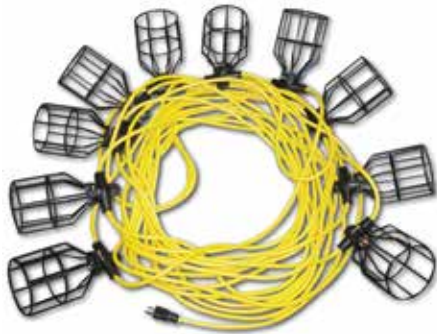

TROUBLE LIGHT

- cUL approved.
- 25' with 1 outlet.
- Reflective guard to provide greater light and safety.
- Suitable for up to 75 Watt bulb.



ITEM NO.	DESCRIPTION	WIRE SIZE	WIRE TYPE
ECTL3075	25' Trouble Light	16/3	SJTW

REPLACEMENT BULBS FOR WORK LIGHTS

ITEM NO.	DESCRIPTION
BULB-300	300 Watt Replacement Bulb
BULB-500	500 Watt Replacement Bulb



ELECTRICAL EXTENSION CORDS

- cUL approved.
- Sleeve packed

ITEM NO.	LENGTH	WIRE SIZE	WIRE TYPE	NO. OF OUT-LETS	AMP RTG.	COLOUR	USE
EC163030	3 M 10'	16/3	SJTW	1	13	ORANGE	INDOOR/ OUTDOOR
EC163050	5 M 16'	16/3	SJTW	1	13	ORANGE	INDOOR/ OUTDOOR
EC163100	10 M 32'	16/3	SJTW	1	13	ORANGE	INDOOR/ OUTDOOR
EC163150	15 M 49'	16/3	SJTW	1	13	ORANGE	INDOOR/ OUTDOOR
EC163300	30 M 98'	16/3	SJTW	1	13	ORANGE	INDOOR/ OUTDOOR
EC143100	10 M 32'	14/3	SJTW	1	13	YELLOW	INDOOR/ OUTDOOR
EC143150	15 M 49'	14/3	SJTW	1	13	YELLOW	INDOOR/ OUTDOOR
EC143300	30 M 98'	14/3	SJTW	1	13	YELLOW	INDOOR/ OUTDOOR
EC123150	15 M 49'	12/3	SJTW	1	13	YELLOW	INDOOR/ OUTDOOR
EC123300	30 M 98'	12/3	SJTW	1	13	YELLOW	INDOOR/ OUTDOOR
EC103300	30 M 98'	10/3	SJTW	1	15A	YELLOW	INDOOR/ OUTDOOR
EC162075	7.5 M 24.5'	16/2	SJTW	1	13	ORANGE	INDOOR/ OUTDOOR
EC162150	15 M 49'	16/2	SJTW	1	13	ORANGE	INDOOR/ OUTDOOR
EC143100-3	10 M 49'	14/3	SJTW	3 (Fan)	13	YELLOW	INDOOR/ OUTDOOR
EC123150-3	15 M 49'	12/3	SJTW	3 (Fan)	13	YELLOW	INDOOR/ OUTDOOR
EC123300-3	30 M 98'	12/3	SJTW	3 (Fan)	13	YELLOW	INDOOR/ OUTDOOR
EC103300-3	30 M 98'	10/3	SJTW	3 (Fan)	15	YELLOW	INDOOR/ OUTDOOR





PLUGS AND CONNECTORS

- cULus listed
- Vinyl TP bodies
- Suitable for cord 6.35 mm - 16.64 mm DIA

ITEM NO.	DESCRIPTION
EC4508	Male Plug 15A-125V
EC5603	Female Socket 15A-125V



TIE WIRE

- Soft black annealed tie wire.
- Ideal for equipment repair and to tie rebar
- Master case 16 pcs
- Pallet 768 pcs.

ITEM NO.	DESCRIPTION	WEIGHT PER COIL
TW-16	16 Gauge Black Tie Wire	3 lbs.
TW-18	18 Gauge Black Tie Wire	3 lbs.



DISPENSER - Tie Wire

- Accomodates standard 3 lb rolls of 16 & 18 gauge tie wire
- 2 1/4" belt loops
- Free wheeling spinner knob for easy wind up
- Aluminum light weight body

ITEM NO.	DESCRIPTION
TWREEL-A	Tie Wire Reel



WIRE-SNARE

- Ideal for snaring rabbits and general fastening.
- Can also be used as a tie-down device.
- Available in 25' coils.
- Each roll header carded.

ITEM NO	LENGTH	WIRE TYPE	AWG GAUGE	SIZE	DESCRIPTION
SWBR-25	25'	Brass	22	.025"	Brass Snare Wire
SWSS-25	25'	Stainless Steel	22	.025"	Stainless Steel Snare Wire

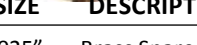

ELECTRICAL EXTENSION CORD Block Heater Style

- cUL approved.
- Sleeve packed.
- Blue colour.
- Good to -45°

ITEM NO.	LENGTH	WIRE SIZE	WIRE TYPE	NO. OF OUTLETS	AMP RTG.	COLOUR	USE
EC163010-3	1m/3'	16/3	SJTW	3	13	BLUE	OUTDOOR
EC163020-3	2m/6'	16/3	SJTW	3	13	BLUE	OUTDOOR
EC163030-3	3m/10'	16/3	SJTW	3	13	BLUE	OUTDOOR
EC163050-3	5m/16'	16/3	SJTW	3	13	BLUE	OUTDOOR
EC163100-3	10m/32'	16/3	SJTW	3	13	BLUE	OUTDOOR
EC163150-3	15m/49'	16/3	SJTW	3	13	BLUE	OUTDOOR



ELECTRICAL INSULATING TAPE

- CSA approved black PVC tape.
- 3/4" x 66', 7 mil thick.
- Temperature range - 7°C to 80°C.
- Dielectric breakdown at 9,000 volts
- Master case 100 pcs.

ITEM NO.	DESCRIPTION
34740-66	0.25 lbs.



DUCT TAPE - General Purpose

- 70 Mesh cloth backing.
- Rubber based adhesive.
- 48mm x 55m roll, standard 3" centre.
- Silver woven finish.

ITEM NO.	DESCRIPTION
DT-3380	Silver Duct Tape 48 mm x 55 m



HIGH VISIBILITY PET SOLAS TAPE CH UNEX

- For application on floating objects.
- Conforms to MED A-1/1.30 retro reflective materials specification.

ITEM NO.	DESCRIPTION
ST-150	2" X 150' Roll (45.7 m x 50 mm)





TEFLON TAPE

- 1/2" x 480" (12mm x 12m), 0.075mm thick.
- 100% TFE fluorocarbon.
- Chemically inert, non-hardening, non-contaminating.
- Temperature range -450° F to 600° F.
- 1,200 pcs. per carton.



ITEM NO.	DESCRIPTION
1102	Case of 1200

BARRICADE TAPE

- Durable polyethylene.
- Used for crowd control and marking off restricted areas.
- 3" wide - 300' or 1,000' in length.
- 2 mil thickness.
- Master case: 12 pcs.



ITEM NO.	SIZE	DESCRIPTION
17779-CA	3" x	300' Yellow/Black Print
17779-CB	3" x	1,000' Yellow/Black Print
17779-DB	3" x	1,000' Red/Black Print

FLAGGING TAPE FLUORESCENT COLOURS Regular Temperature

- 1" x 150'.
- 0.08 mm.
- Durable, matte embossed PVC sheeting.
- Remains pliable in cold weather. Cold crack rated at -20°C.
- Will not chip, peel or crack.
- Non-toxic.
- Highly visible and colourfast.
- Individual rolls - UPC labeled.



Master case: 120 pcs

ITEM NO.	COLOURS
16001	Fluorescent Orange
16002	Fluorescent Pink
16003	Fluorescent Limon
16004	Blue

DISPOSABLE COVERALLS Polyethylene Coated

- Ideal for protecting clothes from paint, dirt and grease.
- Lightweight polyethylene PE coated to resist bleeding through of liquids.
- Comfortable with elastic arm and leg cuffs and attached hood.
- Excellent for DIY marke.
- White, SMS, 50 g/m².



Specifications	M	L	XL	XXL
Chest Size	48"	52"	56"	60"

ITEM NO.	DESCRIPTION
DC-M	Medium Disposable Coverall
DC-L	Large Disposable Coverall
DC-XL	Extra Large Disposable Coverall
DC-XXL	Extra-Extra Large Disposable Coverall

PACKING TAPE - Heavy Duty

- Meets postal requirements.
- Ideal for shipping departments.
- Can be used for re-enforcement of moving boxes.
- Packed 6 rolls per sleeve.
- Hot melt adhesive.

(Minimum order quantity of 6 rolls shown as packed)

ITEM NO.	COLOUR	WIDTH	LENGTH
PT-110	Clear	48mm/2"	100m/330'



TAPE - Reflective Trailer Tape

- 51 mm X 45.7 m (2" X 150') polycarbonate reflective tape.
- High intensity grade.
- Strong adhesive back.
- Red and silver colour
- Exceeds DOT-C2 standards for reflectivity.
- Individually boxed.



ITEM NO.	DESCRIPTION
HRFT-150	Reflective Tape 2" X 150'



PAINT BRUSHES - Polyester Bristle

- Durable plastic handles w/metal ferrule.
- Flagged bristle to retain paint.
- Plastic wrapper includes hanger.
- UPC coded.

ITEM NO.	WIDTH	HAIR LENGTH	PACKING PER CARTON
SA031-050	1/2"	2"	12
SA031-100	1"	2"	12
SA031-150	1 1/2"	2"	12
SA031-200	2"	2"	12
SA031-250	2 1/2"	2"	12
SA031-300	3"	2"	12
SA031-400	4"	2"	12

SA031-5 5 Pc Set Includes 1 Each: 1/2", 1", 1 1/2", 2", 3" Brush. Packed In Plastic Package With Header Card



PAINT BRUSHES - Pure Bristle

- 100% Pure white bristle (flagged).
- Heavy duty 1/2" thick unpainted wooden handle and white bristle.

ITEM NO.	WIDTH	HAIR LENGTH	PACK	MASTER PACK
5051-050	1/2"	1 1/2"	36	432
5052-100	1"	1 1/2"	12	288
5053-150	1 1/2"	1 3/4"	12	288
5054-200	2"	1 3/4"	12	288
5056-300	3"	2 1/4"	12	144
5057-400	4"	2 1/4"	12	144



HAND WIPES (REPLACES 6285-06)



- Wipes are pre-moistened with GOJO heavy duty cleaning solution.
- Extra large 10.5" X 12.25", for superior cleaning capacity.
- Contains skin conditioners to prevent dryness
- Dual textured with scrubbing side and smooth side for quick dirt absorption.
- Use anywhere, no water needed.
- Used to quickly remove oils, grease, paints, inks, tar, dirt, sealants, adhesives, chaulks, polyurethane.
- 72 wipes per cannister.



ITEM NO.	DESCRIPTION
6396-06	72 GOJO Wipes

HAND CLEANER



- For removal of industrial soils, medium dirt and grease.
- Contains baby oil and orange citrus scent.

ITEM NO.	BOTTLE SIZE	DISPENSE METHOD	DESCRIPTION
0958-06	1/2 gallon	Pump	GOJO Orange Lotion with Pumice



HAND CLEANER



- For removal of industrial soils, medium dirt and grease.
- Contains baby oil and orange citrus scent.

ITEM NO.	BOTTLE SIZE	DISPENSE METHOD	DESCRIPTION
----------	-------------	-----------------	-------------

*0947-12 14 Fl. oz. Squeeze GOJO orange lotion with nail brush without pumice

*0957-06 14 Fl. oz. Squeeze GOJO orange lotion with pumice and nail brush

**FOB DARTMOUTH, NS ONLY*



0947-12



0957-06

FILE CARD

- For cleaning debris out of files.

ITEM NO.	DESCRIPTION
FCB-1	Wire Brush W/Polycast Handle, Steel Bristles





PARTS CLEANING BRUSHES

- Polypropylene does not shrink or swell and resists most petroleum based solvents.
- Packed 24 per carton.

ITEM NO.	DESCRIPTION
37P-BR	7" Wire Brush, 3 Rows Brass Bristle Polypropylene Handle Resists Most Petroleum Based Solvents
38P-SS	7" Wire Brush, 3 Rows Stainless Bristle Polypropylene Handle Resists Most Petroleum Based Solvents



PARTS CLEANING BRUSHES

ITEM NO.	DESCRIPTION
236-00	11" Round Parts Brush With Wood Handle And PVC Bristle
237-BR	8" Wire Brush 3 Row Brass Bristle With Wood Handle
238-SS	8" Wire Brush 3 Row Stainless Steel Bristle With Wood Handle



WIRE BRUSHES - Wood Handles

- Four row steel wire.
- Rectangular wood handle.

ITEM NO.	DESCRIPTION
234-4R	12" Contoured Handle
1419-SS	14" 4 X 19 Row Stainless Steel Wire Brush
XP-1419WS	14" 4 X 19 Row Wire Brush With Metal Scraper



WIRE BRUSH - Polycast Handle

- 11" – 15 x 4 row heavy duty wire brush.
- Polycast construction for greater durability.
- Coated steel bristles.
- Equipped with removable 2" plated scraper.



ITEM NO.	DESCRIPTION
233-4R	Wire Brush W/Polycast Handle, Steel Bristles

SCRATCH BRUSHES Plastic Handle with Crimped Wire

- Sturdy metal frame.
- Curved brush to allow brushing in corners.
- Handle colour determines wire material.
- Overall length 10", brush size 5 1/2" x 5/8", trim length 1".
- Packed in 20 pce. display box.

ITEM NO.	WIRE TYPE	HANDLE COLOUR	BRUSH SIZE	WIRE SIZE
USB-Steel	Steel	Red	5 1/2" x 5/8"	0.012
USB-Brass	Brass Coated Steel	Yellow	5 1/2" x 5/8"	0.012
USB-SS	Stainless	Green	5 1/2" x 5/8"	0.012

DISPOSABLE GLOVES



- Industrial Grade.
- Used for protection of hands when handling chemicals and performing other duties requiring isolation between hand and material.
- Packed 100/box (50 pairs).

ITEM NO.	SIZE	MATERIAL TYPE	THICKNESS (mm)			POWDER
			Finger	Palm	Cuff	
<i>Light Powdered</i>						
*LGLP-S	Small	White Latex	.15	.13	.10	Yes
*LGLP-M	Medium	White Latex	.15	.13	.10	Yes
*LGLP-L	Large	White Latex	.15	.13	.10	Yes
*LGLP-XL	X Large	White Latex	.15	.13	.10	Yes

***FOB DARTMOUTH, NS ONLY**

Light Powdered

*NGLP-S	Small	Blue Nitrile	.14	.12	.09	Yes
*NGLP-M	Medium	Blue Nitrile	.14	.12	.09	Yes
*NGLP-L	Large	Blue Nitrile	.14	.12	.09	Yes
*NGLP-XL	X Large	Blue Nitrile	.14	.12	.09	Yes

***FOB DARTMOUTH, NS ONLY**

Powder Free

*NGPF-M	Medium	Blue Nitrile	.15	.12	.09	No
*NGPF-L	Large	Blue Nitrile	.15	.12	.09	No
*NGPF-XL	X Large	Blue Nitrile	.15	.12	.09	No

***FOB DARTMOUTH, NS ONLY**



White Latex

Blue Nitrile

MECHANIC'S GLOVE



- Strong synthetic palm and fingertips to resist tearing.
- Elasticized back to achieve secure fit.
- Loop "N" Hook wrist fastener.
- Available in Red or Black.

ITEM NO.	SIZE
GR-305M	Medium
GR-305L	Large
GR-305XL	Extra Large
GR-305M-R	Medium
GR-305L-R	Large
GR-305XL-R	Extra Large



GENERAL PURPOSE GLOVES



- Soft and durable natural deer skin palm and finger tips.
- Hook and loop wrist fastening.
- Synthetic elasticized black back.

ITEM NO.	SIZE	DESCRIPTION
M133-M	Medium	General Purpose Glove
M133-L	Large	General Purpose Glove
M133-XL	X Large	General Purpose Glove



- High dexterity, oil resistant, polyurethane black palm and finger tips.
- Yellow spandex back with elasticized wrist band.
- Foam padded knuckles.
- Double thickness palm.

ITEM NO.	SIZE	DESCRIPTION
M177-M	Medium	General Purpose Glove
M177-L	Large	General Purpose Glove
M177-XL	X Large	General Purpose Glove



GLOVES

ITEM NO.	DESCRIPTION	
418PBSA	Pigskin work glove with safety cuff. Elastic band on back. Lined palm	
1700PY-UL	Driver's gloves pig grain leather. Slip on cuff. Wing thumb unlined	
1700PY-FL	Driver's gloves pig grain leather, slip on cuff w/elastic back. Wing thumb fleece lined	
5800-P-HL	Pig grain leather work glove. Lined palm. Elastic back. Rubberized safety cuff.	
5800-P-FL	Pig grain leather work glove. Fully fleece lined elastic back. Rubberized lined safety cuff.	
98-WG 98-WGXL	"Winter glove" acrylic fleece lined. Split cowhide palm, fingers and knuckles. Cotton top and lined cotton safety cuff. Black and red colour	
868-DP	Split cowhide leather on fingers & knuckles. Double leather on palm. Gunn cut. Elastic band. Flannel lined palm.	
1162	Cow grain fitters glove. Striped cotton. 1 Pc. Leather palm, fingertips & safety cuff. Elasticized wrist. Half lined. Size 10 1/2.	
1162-XL	As above, size 11 1/2 extra large.	
1163	Cow grain glove with patch palm. Fully felt lined, elastic back, safety cuff.	
1163-XL	As above, size 11 1/2 extra large.	

ITEM NO.	DESCRIPTION	
WG-14L	Split cowhide welders glove. Lined with fleece and denim. Lined gauntlet, black.	
4-S	White double knit with elasticized wrist band. 75% Polyester, 25% cotton. Small size.	
4-M	As above medium size.	
4-L	As above large size.	
4-XL	As above extra large size.	
333-LG	White double knit glove with elasticized wristband 35% Cotton/65% polyester blend.	
*CC7	White cotton glove with elasticized wristband. *FOB DARTMOUTH, NS ONLY	
CC3-C	Camouflage cotton glove with pvc dots on index finger and palm.	
*CC31	White cotton glove with Pvc dots on palm. Index finger & small finger w/ elasticized wristband. *FOB DARTMOUTH, NS ONLY	
361-B	Green fleece glove with knit wrist 35% cotton/65% polyester.	

6899-S Cotton knit glove with blue latex palm, finger & finger ends. Elasticized wristband Size small.

6899-M As above - medium size

6899-L As above - large size



8015FR Fluorescent Orange Pvc Coated Gloves. Elasticized Wristband Fully Lined.



NITB-601 Blue Nitrile Dipped Glove. Cotton Interlocked Base. Elasticized Wristband.



GLOVES - Lined For Colder Temperatures

ITEM NO.	DESCRIPTION	SIZE
WG68-M	Cotton knit glove with blue latex palm, finger & finger ends, elasticized wristband.	Medium
WG68-L	As above	Large
WG68-XL	As above	X-Large



GLOVES - Nitrile Dipped Sticky Glove

Black nylon back with nitrile palm and fingers. Elasticized wrist band. Sticky grip gives more positive holding ability. Very sensitive touch due to thin yet strong material. Can be used in warehouses, construction or automotive.

ITEM NO.	SIZE
NN2-S	Small
NN2-M	Medium
NN2-L	Large
NN2-XL	X-Large



TOQUE AND BALACLAVAS

- 100% Acrylic knit.
- Black colour.
- With handy hang-up hook.



T611

ITEM NO.	DESCRIPTION
T611	Acrylic Knit Toque Lined With Thinsulate® Liner
T615	Acrylic Knit Balaclava. Can Be Used To Expose Eyes And Nose Or Entire Face Ribbed Collar
T616	Acrylic Knit Balaclava With Eye



T615



T616

*LIMITED QUANTITIES
NO BACKORDERS*

KNEE PADS



- Lightweight, durable and strong.
- Made from recycled rubber and polypropylene chips with comfortable, breathable fabric inner liner.
- Pads fasten to leg with flexible Velcro straps.
- Peg hook compatible header card.

ITEM NO.	DESCRIPTION
HD-120	Heavy Duty Knee Pad
PAD-2000	Hardshell Knee Pad With Hinged Hardcover Built For Safety And Long Life Withstands Cold Weather





BARRICADE (SAFETY & SNOW) FENCING

- Strong polyethylene construction.
- Bright orange colour.
- 1 3/4" x 4" opening rectangular design.

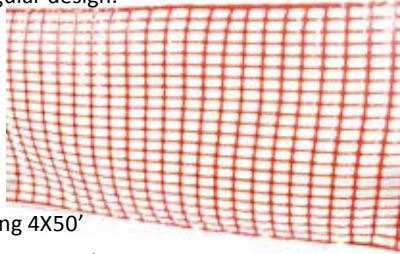

ITEM NO.	DESCRIPTION
----------	-------------

SF-320	Safety/Snow Fencing 4X50'
*SF-100	Safety/Snow Fencing 4X100'

***FOB SURREY, BC ONLY**

TARPAULINS - Blue

- Polyethylene.
- 10 x 10 weave.
- Laminated both sides with 0.03mm coating.
- Aluminum grommets every 3 feet.
- Stitched hem.

ITEM NO.	SIZE IN FT.	WEIGHT
768	6 x 8	1.1 lbs.
7810	8 x 10	1.9 lbs.
71012	10 x 12	2.6 lbs.
71014	10 x 14	3.0 lbs.
71214	12 x 14	3.8 lbs.
71218	12 x 18	4.9 lbs.
71224	12 X 24	6.5 lbs.
71416	14 x 16	5.1 lbs.
71520	15 x 20	6.8 lbs.
71824	18 x 24	9.8 lbs.
72030	20 x 30	13.5 lbs.
72448	24 x 48	26.0 lbs.
73060	30 x 60	41.0 lbs.



TARPAULINS - Natural (White)

- Polyethylene.
- 8 x 7 weave.
- Laminated both sides with 0.03mm coating.
- Aluminum grommets every 3 feet.
- Stitched hem.

ITEM NO.	SIZE IN FT.	WEIGHT
61520	15 X 20	4.9 lbs.
*62030	20 X 30	9.8 lbs.



***FOB DARTMOUTH, NS ONLY**

TARPAULINS - Camouflage

- Polyethylene.
- 10 x 10 weave.
- Laminated both sides with 0.03mm coating.
- Aluminum grommets every 3 feet.
- Stitched hem.

ITEM NO.	SIZE IN FT.	WEIGHT EACH
768-CF	6 x 8	1.1 lbs.
7810-CF	8 x 10	1.9 lbs.
71012-CF	10 x 12	2.6 lbs.
71214-CF	12 x 14	3.8 lbs.
71218-CF	12 x 18	4.9 lbs.
71520-CF	15 x 20	6.8 lbs.
72030-CF	20 x 30	13.5 lbs.



BOOTS - Rubber CSA approved

- Black PVC construction.
- Grade 1 steel toe cap and steel in-step.
- CSA & SD labelled.
- 14" High boot.
- Aggressive tread design.
- American sizes.

ITEM NO.	SIZE
*R199-07	7
*R199-08	8
*R199-09	9
*R199-10	10



***FOB DARTMOUTH, NS ONLY**

**LIMITED QUANTITIES
NO BACKORDERS**

RAINSUITS - 3 pce.

- 75% PVC, 25% polyester.
- Corduroy lined collar on jacket.
- Detachable hood with draw string.
- Bib style pants.
- Ventilation holes on back.
- Strong, long wearing, soft at low temperatures.
- Welded seam.

ITEM NO.	SIZE	COLOUR
RPY-570-S	Small	Yellow
RPY-570-M	Medium	Yellow
RPY-570-L	Large	Yellow
RPY-570-XL	X-Large	Yellow
RPY-570-XXL	XX-Large	Yellow





SAFETY VESTS - 360° REFLECTIVE 5 Point Tear Away

- One size fits all.
- Hook and loop side straps have 2" reflective strip.
- Front and sides has 2" reflective markings and 2" wide "X" on back.
- Made of lightweight knitted polyester.
- Hook and loop front side and shoulder fasteners.
- Fluorescent orange with black nylon edging.



ITEM NO.	DESCRIPTION
V50Y	One Size Fits All Reflective Safety Vest

TRAFFIC WARNING TRIANGLES Folding

- Packed 3 reflective triangles per handled plastic case.
- 17" sides for good visibility.
- Weighted base for stability.
- Meets DOT approval.
- All 3 triangles fit plastic case, 4 3/8" H x 4" W x 17 1/2" L.



ITEM NO.	SIZE
YJ-8F	Folding Traffic Warning Triangles

- Meets CSA 296 Class 2, level 2 requirements.
- One size fits all.
- Hook and loop side straps have 2" silver "3M" reflective markings and 2" silver "3M" reflective "X" on back.
- Made of lightweight, soft, breathable polyester material.
- Hook and loop fastening on shoulder sides and front.
- Lime green with 2" silver reflective strip applied to 4" fluorescent orange strip.
- Vest has two waist and one chest pocket, both with hook and loop fasteners.



ITEM NO.	DESCRIPTION
RS-202	Five-Part Tear Away Vest With "3M" Reflective Strips, Meets CSA 296 Class 2, Level 2 Requirements

DUST MASKS - Disposable

- Adjustable alloy nose bar to assure good fit.
- Approximately 2" depth.
- Strong elastic head band.
- Double strap fastening.



ITEM NO.	DESCRIPTION
DM-05	5 Masks/Plastic Bag
DM-50	50 Masks Per Box

FILTER DUST MASK

- Plastic frame type filter mask.
- 1 extra replacement filter.
- UPC coded.



ITEM NO.	DESCRIPTION
FM-637	Filter Dust Mask

HEARING PROTECTOR - Adjustable Headband Type

- Padded ABS headband.
- Adjustable muff height.
- Headband force 3.0 lbs.
- WCB Class C
- Tests in accordance with ANSI S3.19-1974.

Frequency (Hz)	125	250	500	1000	2000	3150	4000	6300	8000
Mean Attenuation (dB)	8.9	13.7	20.7	26.1	33.2	33.0	34.5	31.3	34.5
Standard Deviation	2.4	2.1	2.0	1.9	2.1	1.7	2.2	2.0	3.4
SNR	23.6								

ITEM NO.	DESCRIPTION
EP-106	Hearing Protector



SAFETY GOGGLES

- Soft PVC frame.
- Elastic head band.
- CE EN166F Certified.



ITEM NO.	DESCRIPTION
SG-201	Direct Vented (Perforated Frame)
SG-204	Indirect Ventilation (Cap Vented)

EAR PLUGS - Disposable Type

- Pre-formed for easy installation.
- ANSI 53.19-1 rated.
- Meets CSA Class A (L) ratings.
- Noise reduction rating 33 dB.
- Each pair cello bagged.
- 200 pairs per dispensing display box
- Cordless, bullet-shaped.



ITEM NO.	DESCRIPTION
EC-1003A	PU Ear Plugs - Orange Colour

REFLECTIVE MARKER POLE Fibreglass

- Used to mark driveways and hazardous areas.
- HiViz fluorescent limon fibreglass to withstand weather and bending.
- Available in two lengths - 60" and 72".
- Made of durable 5/16" Fibreglass to withstand weather and bending.
- Markers have pointed end and PVC capped end for driving

ITEM NO.	DESCRIPTION
MP0860 (Previously 671)	60" Reflective Marker
MP0872 (Previously 681)	72" Reflective Marker

SPORT & SAFETY GLASSES

- Break resistant polycarbonate lens.
- UV400 rated lens.
- Frameless unilens construction.
- Molded nose piece.
- Fog resistant.
- Individual cello bagged with peg holes.

ITEM NO.	LENS COLOUR	FRAME COLOUR	TEMPLE TYPE
CS-A2601C	Clear	Clear	Universal
Sport/Safety Glasses with Wide Side Shield for Wearing Over Prescription Glasses			
CS-A2601Y	Yellow	Clear	Universal
Sport/Safety Glasses with Wide Side Shield for Wearing Over Prescription Glasses			



SPORT & SAFETY GLASSES CONTINUED

- Break resistant polycarbonate lens.
- UV400 rated lens.
- Strong nylon frame and temples.
- Universal nose pads.
- Fog resistant.
- Individual cello bagged with peg holes.

ITEM NO.	LENS COLOUR	FRAME COLOUR	TEMPLE TYPE
CS-228M	Iridium	Black	Universal

Sport/Safety Glasses



CS-321C	Clear	Black	Adjustable
---------	-------	-------	------------

Sport/Safety Glasses with wrap around side protection, meets ANSI Z87.1



CS-321S	Smoke	Black	Adjustable
---------	-------	-------	------------

Sport/Safety Glasses with wrap around side protection, meets ANSI Z87.1



CS-321Y	Yellow	Black	Adjustable
---------	--------	-------	------------

Sport/Safety Glasses with wrap around side protection, meets ANSI Z87.1



CS-1349C	Clear	Smoke	Universal
----------	-------	-------	-----------

Sport/Safety Glasses with side panels, meets ANSI Z87.1



CS-1349G	Green	Smoke	Universal
----------	-------	-------	-----------

Sport/Safety Glasses with side panels, meets ANSI Z87.1



SPORT & SAFETY GLASSES CONTINUED

ITEM NO.	LENS COLOUR	FRAME COLOUR	TEMPLE TYPE
CS-1642C	Clear	Black	Adjustable

Sport/Safety Glasses with wrap around side protection, meets ANSI Z87.1



CS-1642I	Iridium	Black	Adjustable
----------	---------	-------	------------

Sport/Safety Glasses with wrap around side protection, meets ANSI Z87.1



CS-1642S	Smoke	Black	Adjustable
----------	-------	-------	------------

Sport/Safety Glasses with wrap around side protection, meets ANSI Z87.1



CS-1642Y	Yellow	Black	Adjustable
----------	--------	-------	------------

Sport/Safety Glasses with wrap around side protection, meets ANSI Z87.1



CS-1753C	Clear	Black	Universal
----------	-------	-------	-----------

Sport/Safety Glasses meets ANSI Z87.1



CS-1753S	Smoke	Black	Universal
----------	-------	-------	-----------

Sport/Safety Glasses meets ANSI Z87.1

HELMETS - OFF-ROAD
KY128 SERIES

- DOT FMVSS No. 218 approved
- ABS plastic shell with polystyrene liner.
- Full face design.
- Mouth, top and rear vented.
- Double buckle design chin strap.
- Adjustable helmet peak.
- Supplied with handy carry bag.

ITEM NO.	SIZE	COLOUR
KY128-S-BK	Small	Black 243
KY128-M-BK	Medium	Black 243
KY128-L-BK	Large	Black 243
KY128-XL-BK	Extra Large	Black 243
KY128-XXL-BK	XX Large	Black 243
KY128-S-RD	Small	Red 243
KY128-M-RD	Medium	Red 243
KY128-L-RD	Large	Red 243
KY128-XL-RD	Extra Large	Red 243
K128-XXL-RD	XX Large	Red 243



KY128-BK w/243 GRAPHICS

LIMITED QUANTITIES
NO BACKORDERS



KY128-RD w/243 GRAPHICS

ALL HELMETS WITH WEARING INSTRUCTIONS
AND CARE CARD

GRAPHICS MAY NOT BE AS SHOWN

SIZES	HEAD CIRCUMFERENCE
Small	55-56 cm
Medium	57-58 cm
Large	59-60 cm
Extra Large	61-62 cm
Extra-Extra Large	63-64 cm

**HELMETS - MOTORCYCLE
KY118V SERIES**

- DOT FMVSS No. 218 approved.
- ABS plastic shell with polystyrene liner.
- Full face design.
- Mouth, top and rear vented.
- Plastic buckle design chin strap.
- 4" Flip-up multi-position lens.
- Supplied with handy carry bag and colour box.

ITEM NO.	SIZE	COLOUR
KY118V-S-BL	Small	Blue 230
KY118V-M-BL	Medium	Blue 230
KY118V-L-BL	Large	Blue 230
KY118V-XL-BL	Extra Large	Blue 230
KY118V-S-RD	Small	Red 230
KY118V-M-RD	Medium	Red 230
KY118V-L-RD	Large	Red 230
KY118V-XL-RD	Extra Large	Red 230
KY118V-XXL-RD	XX Large	Red 230
KY118V-VIS	Replacement Visor for KY118V Series	

KY118V-BL w/230 GRAPHICS

LIMITED QUANTITIES
NO BACKORDERS

KY118V-RD w/230 GRAPHICS

SIZES	HEAD CIRCUMFERENCE
Small	55-56 cm
Medium	57-58 cm
Large	59-60 cm
Extra Large	61-62 cm
Extra-Extra Large	63-64 cm

**HELMETS - MOTORCYCLE/SNOW MOBILE/OFF-ROAD
K51 SERIES**

- DOT FMVSS No. 218 approved.
- Open-face design.
- Camo helmets are fabric covered.
- Offers ear protection.
- Clear 6 1/2" multi-position flip-up visor.
- Supplied with handy carry bag.

ITEM NO.	SIZE	COLOUR
K51-S-BK	Small	Black
K51-M-BK	Medium	Black
K51-L-BK	Large	Black
K51-XL-BK	Extra Large	Black
K51-XXL-BK	XX Large	Black
K51-S-CF	Small	Camouflage
K51-M-CF	Medium	Camouflage
K51-L-CF	Large	Camouflage
K51-XL-CF	Extra Large	Camouflage
K51-XXL-CF	XX Large	Camouflage
K51-VIS	Replacement Visor/Screw Set For K51 Series	

K51-BK BLACK

LIMITED QUANTITIES
NO BACKORDERS

K51-CF CAMOUFLAGE

**ALL HELMETS WITH WEARING INSTRUCTIONS
AND CARE CARD**

GRAPHICS MAY NOT BE AS SHOWN

OUTDOOR & CAMPING KNIVES MORAKNIV (COMPANION SERIES) - Made in Sweden

- Ideal for search and rescue.
- Supplied with fluorescent plastic belt clip sheath.
- 4" stainless steel blade.
- Rubber coated hand grip on plastic handle.
- Distinctive fluorescent ends on handle.
- 15 Pc display master carton.



ITEM NO.

DESCRIPTION

11824-BK	Fluorescent Orange Handle Ends And Sheath
12090-SC	Above Knife Blister Carded



OUTDOOR AND CAMPING KNIVES MORAKNIV (companion series) - Made in Sweden (Fluorescent Orange)

- 4" stainless steel blade with 2 1/4" serrated section.
- Distinctive fluorescent coloured ends on black rubber coated handle.
- Rubber coated hand grip.
- Supplied with orange plastic belt clip sheath.
- 15 Pc display master carton.



ITEM NO.

DESCRIPTION

11829-BK	Serrated Blade Knife, Fluorescent Orange Ends And Sheath
----------	---

OUTDOOR/CAMPING KNIVES MORAKNIV (COMPANION SERIES) Made in Sweden

- 4" Stainless steel blade.
- High friction rubber gripped handle.
- Multi-colour handles and sheaths.
- Available in display, 3 each black, anthracite, navy blue, military green, desert.
- Colour co-ordinated sheath with clip-on fastener.



ITEM NO.

DESCRIPTION

13089-15D	Companion Series Knife with Stainless Steel Blade in 15 Piece Display
-----------	---

OUTDOOR & CAMPING KNIVES MORAKNIV (COMPANION SERIES) - Made in Sweden

- Military green sheath and handle ends.
- Supplied with military green belt clip sheath.
- 4" Blade.
- Rubber coated hand grip on plastic handle.
- 15 Pc display master carton.



ITEM NO.

DESCRIPTION

11863-BK	4" Carbon Steel Blade With Military Green and Black Handle
11827-BK	4" Stainless Steel Blade With Military Green Handle Ends
12215-SC	4" Stainless Steel Blade With Military Green Handle Ends. Blister Carded

OUTDOOR/CAMPING KNIVES MORAKNIV (COMPANION SERIES) - Made in Sweden

- 4" Stainless steel blade.
- High friction rubber gripped handle.
- Multi-colour handles and sheaths.
- Available in display, 3 each blue, green, black, dark pink and fluorescent orange.
- Colour co-ordinated sheath with clip-on fastener.
- 15 Pc display master carton.

ITEM NO.

DESCRIPTION

12884-15D (Previously 12095-15D)	Companion Series Knife with Stainless Steel Blade in 15 Piece Display
M-12141	4" SS Companion Knife - Black Handle
M-12157	4" SS Companion Knife - Magenta Handle
M-12158	4" SS Companion Knife - Green Handle
M-12159	4" SS Companion Knife - Blue Handle



OUTDOOR & CAMPING KNIVES (COMPANION RESCUE) - Made in Sweden

- 3.9" Stainless steel blade.
- Serrated cutting edge for cutting rope, nylon or poly.
- Comfortable rubber grip and belt clip sheath.
- Blunt end for safety.
- Red colour sheath and handle ends
- 15 pc display.



ITEM NO.	DESCRIPTION
11828-BK	Companion Rescue Knife with Stainless Steel Blade

SPORT/FISHING KNIVES Made in Sweden

- Molded polypropylene handle with guard.
- Molded polypropylene combi sheath.
- Blades 3.5", total length 8".
- Packed in display box, 15 pcs.

ITEM NO.	DESCRIPTION
M-13246	Basic 546 Series (Orange/Black) SS
M-13248	Basic 511 Series (Tan/Black) Carbon Steel

HEAVY DUTY OUTDOOR & CAMPING KNIVES (COMPANION SERIES) - Made in Sweden

- Heavy duty 3.2 mm thickness blade.
- Matching colour clip-on sheath and handle ends.
- 27° Edge angle for sharpness retention.
- Decorative display boxed.
- Master Carton: 10 Pieces.

ITEM NO.	DESCRIPTION
12494-BK	4.1" Carbon Steel Blade-Military Green
12495-BK	4.1" Carbon Steel Blade-Orange

OUTDOOR AND CAMPING KNIFE (PRO-S SERIES) - Made in Sweden

- Two tone rubber grip handle.
- 3 1/3" stainless steel blade.
- Supplied with belt clip plastic sheath.
- Flexible blade.
- Blister carded.



ITEM NO.	DESCRIPTION
12540-SC	3 1/2" Blade Stainless Steel

SPORT AND FISHING KNIVES Made in Sweden

- Molded polypropylene handle with guard.
- Molded polypropylene combi sheath.
- New larger handle.
- 15 pc display master carton.

ITEM NO.	DESCRIPTION
BASIC511-BK	3.6" Carbon Steel Blade
BASIC546-BK	3.6" Stainless Steel Blade

OUTDOOR/CAMPING/ SURVIVAL KNIFE (BUSHCRAFT BLACK SERIES) - Made in Sweden

- 4 1/8" Heavy duty carbon steel blade is 3.2 mm thick.
- Blade is coated with black coating to resist corrosion.
- Blade tang extends 3/4 way into handle.
- Blade spine is shaped to use with fire starter.
- Rubber coated handle to provide positive grip.
- Multiposition plastic sheath w/belt clip & belt loop.
- Clam shell packed for easy display.

ITEM NO.	DESCRIPTION
10791-SC	Bushcraft Black Knife w/ 4 1/8" Coated Carbon Blade



KANSBOL OUTDOOR & CAMPING KNIFE - Made in Sweden

- Made from Swedish stainless steel (12C27).
- Blade length: 4.3" and is 0.1" thick.
- Profile shaped blade for added precision.
- Spine is ground so it can be used with fire starter.
- Secure grip handle for safety and comfort.
- Supplied with belt loop plastic sheath.
- Military green colour.
- Master Carton: 5 Pieces.



ITEM NO.	DESCRIPTION
12634-BK	Heavy Duty General Purpose Stainless Steel Knife

CAMPING KNIFE - Eldris by Mora MORAKNIL Neck Knives

- Great for outdoor hiking because of it's small size.
- Great for skinning.
- Blade is made from 12C 27 Sandvik stainless steel.
- Supplied with plastic sheath.
- Rubberized grip.
- Attractively boxed.
- Master Carton: 10 Pieces.



ITEM NO.	DESCRIPTION
12647-BK	2 1/8" Stainless Steel Blade Black Handle
12648-BK	2 1/8" Stainless Steel Blade Red Handle

SKINNING KNIFE Made in Sweden

- 6" curved stainless steel blade.
- 5" slip-resistant polypropylene handle.



ITEM NO.	DESCRIPTION
7146-5	Skinning Knife

ROEING AND BLEEDING KNIFE MORAKNIL

- Molded black polypropylene handle with rough structure.
- Swedish cold-rolled stainless steel blade.
- Ball tip specially designed to protect the pulp when cleaning fish.
- Black composition belt clip with sheath.
- Master Carton: 10 Pieces..



ITEM NO.	DESCRIPTION
950P	68 mm (2.7") Stainless Steel Blade

***FOB DARTMOUTH, NS ONLY**

FILLET KNIFE (SPORT FISHING) Made in Sweden

- 6" Cold-rolled stainless steel blade with high friction rubber grip.
- Medium flex blade.
- Easy clean vented plastic sheath.
- Master Carton: 10 Pieces.



ITEM NO.	DESCRIPTION
11892-SC	6" Rubber Gripped Fillet Knife, Blister Carded

FILLET KNIVES Made in Sweden

- Plastic molded handles with rough surface.
- Flexible stainless steel blades.
- Blades are hardened to 57-58 HRC.
- Master carton 10 pcs.

ITEM NO.	DESCRIPTION
----------	-------------

299P 4 1/2" Blade Fillet Knife (Semi-flexible) With Stainless Steel Spoon



299P & 9152P

9152P 6" Blade Fillet Knife (Stiff) With Stainless Steel Spoon

9197P 7 1/2" Narrow Style Fillet Knife (Flexible)

9197P

9160P 6 1/4" Flexible Blade Fillet Knife

9160P

9180P 7" Flexible Blade Fillet Knife

9180P

KITCHEN AND BUTCHER KNIVES Made in Sweden

- Stainless steel blades with comfortable sealed plastic handles that conform to Health - Safety Standards.
- Stainless steel blades are hardened to 57 - 58 Rockwell C, which makes the blades very hard so as to maintain a sharp edge yet still remaining flexible to avoid breakage.
- Fully guaranteed against manufacturers defects..
- Master Carton: 10 Pieces.

ITEM NO.	DESCRIPTION	BLADE LENGTH
----------	-------------	--------------

*9153P Meat Knife 6"

*9210P Meat Knife 8 3/4"



***FOB SURREY, BC ONLY**

“MORA” ORIGINAL KNIVES
Made in Sweden by E. Jonsson

- Carbon steel blade.
- Wood handle.
- Thick plastic sheath.
- Through handle blade tang.
- Safety finger guard.

ITEM NO.	SIZE
1-100	4" Blade
2-112	4 1/2" Blade

MACHETES - Made in Brazil
TRAMONTINA

- Steel SAE 1070.
- Hardness: 48 to 52 RC.
- Wood handles with nickel-plated rivets.
- Supplied with vinyl sheath.

ITEM NO.	DESCRIPTION
2610-18	18" Blade With Vinyl Sheath
2610-22	22" Blade With Vinyl Sheath

KNIFE - SKINNING & BONING KNIVES (FILLET) **Made in Brazil**
TRAMONTINA

- Krupp 1.14110 or Sandvik (12C27) Stainless Steel Blades with 55HRC hardness.
- Textured polypropylene handles for comfort and safety.
- NSF® for health safety issues.

ITEM NO.	DESCRIPTION
24606-056	6" Skinning Knife, Yellow Handle
2426-6	6" Boning Knife, White Handle
24605-087	7" Boning (Fillet) Knife White Handle, Stiff Blade

FIELD DRESSING KNIFE
Folding
CH UNEX

- 3 - 3 1/2" blades: 1 x sawing, 1 x ut hook blade and 1 standard blade.
- standard blade and gut hook blade both have lock-back feature.
- Stainless steel blades.
- ABS handle with slip resistant rubber inlay.
- 4 3/4" overall closed length.
- Supplied with nylon sheath with belt loop.
- Clamshell carded.

ITEM NO.	DESCRIPTION
GHH-383	Field Dressing Kife With Sheath

FILLET KNIFE - Made in Brazil
TRAMONTINA

- Stain free high carbon blade Krupp or Sandvik 12C27 SS.
- NSF food safe handle.
- Semi-flexible blade.
- Blade is 8 1/2" long.

ITEM NO.	DESCRIPTION
24622-088	8 1/2" Filleting Knife

FIELD DRESSING KNIFE
CH UNEX

- Designed for fast and easy game dressing.
- Vinyl sheath with belt loop.
- Chrome plated.
- Clamshell carded.

ITEM NO.	DESCRIPTION
R-06	Dressing Knife With Sheath
R-06BL	Replacement Blade, 2 per card

BONING KNIFE
CH UNEX

- Stain resistant, carbon steel blade.
- Plastic handle with finger guard.
- Individually poly-bagged.

ITEM NO.	DESCRIPTION
TOP-BN6	6" Boning Knife With Finger Guard Plastic Handle



PARING KNIVES

- Nylon or plastic handles.
- Carbon steel blades.
- Individually poly-bagged.



ITEM NO.	DESCRIPTION
TOP-002	Paring (Net) Knife With 3 1/2" Serrated Blade, Nylon Handle
TOP-003	Paring Knife With 3 1/2" Smooth Blade, Plastic Handle

POCKET KNIVES Lock Back Blade Design

- Spring side bar locking.
- Stainless steel blades.
- Slip-on belt clips.
- All one handed opening.
- Single blade design.
- Clamshell carded.

ITEM NO.	BLADE LENGTH	CLOSED LENGTH
BF010529MCT	3"	4"

Half serrated blade with partial ABS and stainless handle.

*LIMITED QUANTITIES
NO BACKORDERS*



BF011459	3 1/4"	4 3/4"
----------	--------	--------

Smooth blade with stainless and partial ABS handle.

*LIMITED QUANTITIES
NO BACKORDERS*



BF011324	3 1/4"	4 3/4"
----------	--------	--------

Smooth blade with stainless and partial slip resistant ABS handle.

*LIMITED QUANTITIES
NO BACKORDERS*



FOLDING POCKET KNIFE Barlow Design

- 2 Stainless steel blades: 2" & 2 3/4".
- Brass sleeves.
- Triple riveted wood handle.
- Stainless steel bolster.
- Clamshell carded.



ITEM NO.	DESCRIPTION
NK-414	Barlow Pocket Knife

*LIMITED QUANTITIES
NO BACKORDERS*

FOLDING POCKET KNIFE Lock Back

- Stainless steel blades.
- Stainless steel bolsters.
- Brass rivets.
- Pakka wood handle.
- End bolster drilled for lanyard.
- Supplied with nylon web sheath with belt loop.
- Boxed.



ITEM NO.	DESCRIPTION	OVER-ALL LENGTH	CLOSED BLADE LENGTH
XSC22222	Lock Back Knife	5"	4"

*LIMITED QUANTITIES
NO BACKORDERS*

SHARPENING STEELS

- Plastic handles with handle hang-up ring.
- Molded finger guard.
- Individually poly bagged.



ITEM NO.	DESCRIPTION
TOP-003ST-12	12" Oval Diamond Steel
TOP-004ST-12	12" Round Medium Grit Magnetized Steel

SHARPENER - For Knives & Scissors

- Two sharpening profiles: one for knives, one for scissors.
- Long lasting carbide cutting block.
- Protective hand grip.
- Sharpens straight and serrated blades.
- Blister carded.



ITEM NO.	DESCRIPTION
DS01005	Knife & Scissor Sharpener

COMBINATION SHARPENING STONE

- 8" long aluminum oxide.
- Fine and coarse sides.
- For sharpening high quality steel tools.

ITEM NO.	DESCRIPTION
812-2011	2 1/2" W x 8" L 1 1/4" Thickness



FIRE STARTER

- Ideal for camping or survival kits.
- Works wet or dry.
- Generates extremely hot sparks.
- Used with some dry tinder fires can be started very easily.
- Supplied with wrist lanyard and striking steel.
- 3" Blade, 4 1/4" overall.
- Carded.

**GUN TRIGGER LOCK
Combination Type**

- Heavy alloy construction.
- Ratchet action to fasten on trigger.
- Fits most guns.
- Mark-proof rubber cushions prevent scratching.
- Carded and UPC coded.
- Combination can be easily changed at any time.
- Master carton: 72 Pieces..



ITEM NO.	DESCRIPTION
----------	-------------

BG010662 Fire Starter

ITEM NO.	DESCRIPTION
----------	-------------

M-802C Combination Type Gun Trigger Lock

BINOCULARS

- Fully adjustable interpupillary distance (distance between eyes.)
- Adjustable diopter setting and central focussing.
- Roll down eyecups for use with glasses.
- All binoculars supplied with nylon carrying bag (BN-0821 has belt loop), neck lanyard, and lens cleaning cloth.
- Attractively boxed.

BN-0821



BN-1050



ITEM NO.	DESCRIPTION
----------	-------------

BN-0821 8 x 21 Magnification

BN-1050 10 x 50 Magnification

CROWN CABLE GUN LOCK

- PVC coated aircraft cable and lock body to protect against scratching.
- Used as a gun lock, cable can be inserted through loading port to the ejection port then locked.
- Packed in poly-bag with header.
- Master carton: 72 Pieces.

ITEM NO.	DESCRIPTION	STD. PACK
----------	-------------	-----------

CBL-007 Cable Gun Lock And Bicycle Lock (Keyed Different) 12

CBL-007-KA3 Cable Gun Lock And Bicycle Lock (Keyed Alike) 12

GUN TRIGGER LOCKS

- Heavy alloy construction.
- Fast ratchet action to lock-on to weapon.
- Versatile to fit most guns.
- Mark-proof rubber cushions prevent scratching.
- Supplied with 2 keys.
- Carded.
- Available keyed different and keyed alike.
- Packing carton (12 pieces) converts to display box.
- Master carton: 72 Pieces..

RIFLE SCOPE WITH MOUNTING RINGS

- Large notched focus ring.
- Fast acting octagonal notched magnification ring.
- See through amber shaded lens protector provides, not only protection but also reduced glare.
- Elevation and windage adjustments have very smooth, and positive click positions.
- Supplied with mounting rings.
- Boxed.

ITEM NO.	MAGNIFICATION
----------	---------------

RS-3940 3 X 9 X 40



ITEM NO.	DESCRIPTION	STD. PACK
----------	-------------	-----------

UTL-KD Gun Lock – Keyed Different 12

UTL-KA1 Gun Lock – Keyed Alike Group 1 12

UTL-KA2 Gun Lock – Keyed Alike Group 2 12

UTL-KB Keyblank for Unex trigger lock.

CHEST WADERS - Olive Green

- 420 D nylon with PVC backing.
- Double stitched and heat tape seams.
- Quick release buckle on suspenders and waist belt.
- Large chest pocket on inside.
- Reinforced knees.
- Molded PVC treaded boot with 4mm neoprene lining and removable taxon insoles.
- Sizes marked on boot.

ITEM NO.	US SIZE
NCW008-07	7
NCW008-08	8
NCW008-09	9
NCW008-10	10
NCW008-11	11
NCW008-12	12
NCW008-13	13



ANCHORS - Danforth Type

- Hot Dipped Galvanized Finish.

**Note : Anchors should weigh approx. 1.5kg for every meter of vessel length.*

ITEM NO.	WEIGHT	
* DF-044	2 kg.	(4.4 lbs.)
*DF-176	8 kg.	(17.6 lbs.)
*DF-220	10 kg.	(22 lbs.)
DF-440	20 kg.	(44 lbs.)

***FOB SURREY, BC ONLY**



ANCHORS - Folding Type

- For boats and small watercraft.
- Hot dipped galvanized finish.
- Collapsible to reduce storage space required.
- Locking collar to lock in collapsed or open positions.

ITEM NO.	WEIGHT	APPROX. LENGTH (A) EYE TO EYE	APPROX. EXTENDED WIDTH (B)
*708-01	0.07 kg. (1.5 lbs.)	6.5"	6.5"
*708-02	1.5 kg. (3.3 lbs.)	11"	11"
708-04	3.2 kg. (7.0 lbs.)	15"	14"
708-05	4.0 kg. (8.8 lbs.)	16.5"	15.75"
*708-06	6.0 kg. (13.2 lbs.)	20"	19.25"
*708-07	8.0 kg. (17.6 lbs.)	20.5"	23"
708-08	10.0 kg. (22.0 lbs.)	22.5"	24.5"
708-09	12.0 kg. (26.4 lbs.)	24.25"	25"
708-10	15.0 kg. (33 lbs.)	24.5"	27"

***FOB SURREY, BC ONLY**



HIP WADERS - Olive Green

- 420 D nylon with PVC backing.
- Double stitched and heat tape seams.
- Adjustable elastic belt loops.
- Reinforced knees.
- Molded PVC treaded boot with 4mm neoprene lining and removable taxon insoles.
- Sizes marked on boot.

ITEM NO.	US SIZE
NHW008-07	7
NHW008-08	8
NHW008-09	9
NHW008-10	10
NHW008-11	11
NHW008-12	12
NHW008-13	13

