

AudioMaster® Public Address High-Powered Amplifiers

**Models CTS2-300, CTS2-600, CTS2-1250, CTS2-300N, CTS2-600N
CTS2-1250N, CTS2-2400N**



Description, Specifications, Installation, and Operation Manual

Limited Warranty

This product is subject to and covered by a limited warranty, a copy of which can be found at www.fedsig.com/SSG-Warranty. A copy of this limited warranty can also be obtained by written request to Federal Signal Corporation, 2645 Federal Signal Drive, University Park, IL 60484, email to info@fedsig.com or call +1 708-534-3400.

This limited warranty is in lieu of all other warranties, express or implied, contractual or statutory, including, but not limited to the warranty of merchantability, warranty of fitness for a particular purpose and any warranty against failure of its essential purpose.



2645 Federal Signal Drive
University Park, Illinois 60484-3167

www.fedsig.com

Customer Support 800-344-4634 • +1 708 534-3400

Technical Support 800-524-3021 • +1 708 534-3400

All products indicated are trademarks of Federal Signal Corporation.
All other product names or trademarks are properties of their respective owners.

Contents

Safety Messages	8
FCC Compliance Notice	9
Declaration of Conformity	10
EMC Standards.....	10
Safety Standard	11
General Description	12
Introduction	12
CTS2 Specifications	12
Features for All Models	12
Features (Network Capable Models)	13
Front Panel Features	13
Indicators	13
Back Panel Features (CTS2-300, CTS2-600, CTS2-1250)	14
Back Panel Features (CTS2-300N, CTS2-600N, CTS2-1250N)	15
Back Panel Features (CTS2-2400N)	16
How to Use This Manual	17
Setup	17
1. Unpack Your Amplifier	17
2. Install Your Amplifier.....	17
3. Ensure Proper Cooling.....	18
4. Choose Input Wire and Connectors.....	19
5. Choose Output Wire and Connectors	19
6. Per Channel Settings	20
Hi-Z	20
Channel Attenuators	21
7. Protection System.....	21
Thermal Indicator	21
Fault.....	21
Auto Insertion High-Pass Filters	21
AC Under/Over Voltage Protection	21
Fuse.....	21

Fan-cooled Chassis	22
Universal Switching Power Supply	22
8a. Setup and System Configuration (CTS2-300, CTS2-600, CTS2-1250).....	22
Global Settings.....	22
Connect Loudspeakers and Configure for Loudspeaker Load	23
Determine load impedances and power requirements	23
Dual Mode Low-Z (8, 4, or 2 Ohm)	23
Bridge Mode (16, 8, or 4 Ohm)	24
Dual Mode Hi-Z (70V/100V).....	25
Bridge Mode Hi-Z (140V/200V).....	26
Connect to AC Mains	26
Startup Procedure.....	27
Precautions.....	27
8b. Setup and Configuration (CTS2-300N, CTS2-600N, CTS2-1250N, CTS2-2400N).....	28
Connect to AC Mains	28
Startup Procedure.....	28
Precautions.....	29
Software Setup	29
NetSetter.....	31
Offline/Online	40
Setup and System Configuration	43
General Purpose In/Out Control Port.....	51
Aux Port/Sleep/Amp Status (CTS2-300N, CTS2-600N, CTS2-1250N).....	56
BLU link.....	57
Advanced Operation	63
Signal Path	75
Troubleshooting	76
Specifications	79
AC Power Draw and Thermal Dissipation.....	82
Getting Technical Support and Service.....	90
Product Registration.....	90

Tables

Table 1 CTS2 Specifications.....	12
Table 2 Front Panel Visual Indications	13
Table 3 Back Panel Features (CTS2-300, CTS2-600, CTS2-1250).....	14
Table 4 Back Panel Features (CTS2-300N, CTS2-600N, CTS2-1250N).....	15
Table 5 Back Panel Features (CTS2-2400N).....	16
Table 6 Wire Size Guidelines	19
Table 7 Channel Attenuators	21
Table 8 Total Latency	62
Table 9 Dual-Mode - All Channels Driven.....	79
Table 10 Bridge Mono Mode - All Channels Driven	79
Table 11 Input Sensitivity.....	79
Table 12 Dimensions	79
Table 13 Performance Specifications for Analog	80
Table 14 Performance Specifications for Network.....	81
Table 15 CTS2 300 - Bridge.....	82
Table 16 CTS2-300 - Dual	83
Table 17 CTS2-300N - Bridge.....	83
Table 18 CTS2-300N - Dual	84
Table 19 CTS2-600 - Bridge	84
Table 20 CTS2-600 - Dual	85
Table 21 CTS2-600N - Bridge.....	85
Table 22 CTS2-600N - Dual	86
Table 23 CTS2-1250 - Bridge	86
Table 24 CTS2-1250 - Dual	87
Table 25 CTS2-1250N - Bridge.....	87
Table 26 CTS2-1250N - Dual	88

Table 27 CTS2- 2400N - Bridge.....	88
Table 28 CTS2-2400N - Dual	89

Figures

Figure 1 Font of Amplifier	14
Figure 2 CTS2 Channel Series Dimensions	18
Figure 3 Airflow	18
Figure 4 Balance and Unbalance Input Connector Wiring	19
Figure 5 Typical Output Connector Wiring	20
Figure 6 System Wiring Dual Mode	23
Figure 7 System Wiring Bridge Mode.....	24
Figure 8 System Wiring for 70V/100V Operation	25
Figure 9 System Wiring for 70V/100V Operation	26
Figure 11 NetSetter Window	31
Figure 13 Offline Device Tab	40
Figure 14 Add Device	40
Figure 15 Going Online Mode.....	42
Figure 16 Amplifier Factory Control Panel.....	42
Figure 17 Amplifier DSP Functions.....	43
Figure 18 Amplifier Mode Settings: Hi-Z and Low-Z	44
Figure 19 Amplifier Mode Settings: Cascading	44
Figure 20 Amplifier DSP Functions: Cascading	45
Figure 21 Amplifier Mode Setting: Bridge Mono	45
Figure 22 Amplifier DSP Functions Setting: Bridge Mono	46
Figure 23 System Wiring Dual Mode	47
Figure 24 Amplifier Mode Setting-Low-Z.....	47
Figure 25 System Wiring Bridge Mode.....	48
Figure 26 Amplifier Mode Setting-Bridge Mode	48

Figure 27 System Wiring for 70 Vrms/100 Vrms Operation	49
Figure 28 Amplifier Mode Settings-Dual Mode Hi-Z	49
Figure 29 System Wiring for 140 Vrms/200 Vrms Operation	50
Figure 30 Amplifier Mode Settings-Bridge Mode Hi-Z	50
Figure 31 Control Port Configuration Page	52
Figure 32 Assigning the “Current Preset” parameter to Control Port Input 1	53
Figure 33 Output Faders and Output Mutes	54
Figure 34 Control Port Output Configuration	55
Figure 35 Input Configuration	60
Figure 36 BLU link Input Channel Assignment	60
Figure 37 BLU link Output Configuration.....	61
Figure 38 Basic Speaker Tuning Panel	64
Figure 39 Basic Speaker Tuning Panel.....	65
Figure 40 Amplifier DSP Functions.....	67
Figure 41 Amplifier DSP Functions: Levels, Faders, Mute.....	68
Figure 42 Input Signal Router	70
Figure 43 Source Routing/Configuration	70
Figure 44 Input Delay	71
Figure 45 Input EQ.....	72
Figure 46 Crossover Filters.....	73
Figure 47 Output Limiters.....	74
Figure 48 CTS2 Signal Path.....	75

Safety Messages

⚠ WARNING

It is important to follow all instructions shipped with this product. This device is to be installed by trained personnel who are thoroughly familiar with the country electric codes and will follow these guidelines as well as local codes.

1. Read these instructions.
2. Keep these instructions.
3. Heed all warnings.
4. Follow all instructions.
5. Do not use this apparatus near water.
6. Clean only with a dry cloth.
7. Do not block any ventilation openings. Install in accordance with the manufacturer's instructions.
8. Do not install near any heat sources such as radiators, heat registers, stoves, or other apparatus (including amplifiers) that produce heat.
9. Do not defeat the safety purpose of the polarized or grounding-type plug. A polarized plug has two blades with one wider than the other. A grounding-type plug has two blades and a third grounding prong. The wide blade or the third prong is provided for your safety. If the provided plug does not fit into your outlet, consult an electrician for replacement of the obsolete outlet.
10. Protect the power cord from being walked on or pinched, particularly at plugs, convenience receptacles, and the point where they exit from the apparatus.
11. Only use attachments/accessories specified by the manufacturer.
12. Use only with a cart, stand, tripod, bracket, or table specified by the manufacturer, or sold with the apparatus. When a cart is used, use caution when moving the cart/apparatus combination to avoid injury from tipping over.
13. Unplug this apparatus during lightning storms or when unused for long periods of time.
14. Refer all servicing to qualified service personnel. Servicing is required when the apparatus has been damaged in any way, such as power-supply cord or plug is damaged, liquid has been spilled or objects have fallen into the apparatus, the apparatus has been exposed to rain or moisture, does not operate normally, or has been dropped.
15. Use the mains plug to disconnect the apparatus from the mains.
16. To reduce the risk of fire or electric shock, do not expose this apparatus to rain or moisture.

17. Do not expose this equipment to dripping or splashing and ensure that no objects filled with liquids, such as vases, are placed on the equipment.
18. The mains plug of the power supply cord shall remain readily operable.

Safety Messages to Installers

- To prevent electric shock, do not remove the top or bottom covers. No user serviceable parts inside. Refer servicing to qualified service personnel.
- To completely disconnect this equipment from the AC mains, disconnect the power supply cord plug from the AC receptacle. The mains plug of the power supply cord shall remain readily operable.
- **IMPORTANT:** CTS2 Series amplifiers require Class 2 output wiring

Magnetic Field

⚠ CAUTION

- Do not locate sensitive high-gain equipment such as pre-amplifiers directly above or below the unit. Because this amplifier has a high-power density, it has a strong magnetic field which can induce hum into unshielded devices that are located nearby. The field is strongest just above and below the unit.

If an equipment rack is used, we recommend locating the amplifier(s) in the bottom of the rack and the preamplifier or other sensitive equipment at the top.

FCC Compliance Notice

This device complies with part 15 of the FCC rules. Operation is subject to the following two conditions: (1) This device may not cause harmful interference, and (2) this device must accept any interference received, including interference that may cause undesired operation.

⚠ CAUTION

Changes or modifications not expressly approved by the party responsible for compliance could void the user's authority to operate the equipment.

NOTE: This equipment has been tested and found to comply with the limits for a Class B digital device, pursuant to part 15 of the FCC Rules. These limits are designed to provide reasonable protection against harmful interference in a residential installation. This equipment generates, uses, and can radiate radio frequency energy and, if not installed and used in accordance with the instruction manual, may cause harmful interference to radio communications. However, there is no guarantee that interference will not occur in a particular installation. If this equipment does cause harmful interference to radio or television reception, which can be determined by turning the equipment off and on, the user is encouraged to try to correct the interference by one or more of the following measures:

- Reorient or relocate the receiving antenna.
- Increase the separation between the equipment and receiver.

Safety Messages

- Connect the equipment into an outlet on a circuit different from that to which the receiver is connected.
- Consult the dealer or an experienced radio/TV technician for help.

Declaration of Conformity

Our products meet the appropriate British and International standards. A product Declaration of Conformity statement is available for each of the product ranges (available on request). This covers both the EMC and Low Voltage Directives.

Equipment Type: Commercial Audio Power Amplifiers

Family Name: CTS2

Model Names: CTS2-300, CTS2-600, CTS2-1250, CTS2-2400

EMC Standards

EN 55103-1:2009 +A1:2012 EMC Compatibility – Product Family Standard for Audio, Video, Audio-Visual and Entertainment Lighting Control Apparatus for Professional Use, Part 1: Emissions

EN 55103-1:2009 +A1:2012 Magnetic Field Emissions – Annex A at 10 cm and 20 cm

EN 61000-3-2:2006 +A1:2008 +A2:2009 Limits for Harmonic Current Emissions (equipment input current less than or equal to 16 A)

EN 61000-3-3:2013 Limitation of Voltage Fluctuations and Flicker in Low-Voltage Supply systems Rated Current less than or equal to 16 A

EN 55022:2012 Limits and Methods of Measurement of Radio Disturbance Characteristics of ITE: Radiated, Class B Limits; Conducted, Class A

EN 55103-2:2009 EMC Compatibility – Product Family Standard for Audio, Video, Audio-Visual and Entertainment Lighting Control Apparatus for Professional Use, Part 2: Immunity

EN 61000-4-2:2009 Ed 9 Electrostatic Discharge Immunity (Environment E2-Criteria B, 4 kV Contact, 8k V Air Discharge)

EN 61000-4-3:2010 Ed 3.2 Radiated, Radio-Frequency, EMC Immunity (Environment E2, Criteria A)

EN 61000-4-4:2012 Ed12 Electrical Fast Transient/Burst Immunity (Criteria B)

EN 61000-4-5:2014 Surge Immunity (Criteria B)

EN 61000-4-6:2009 Immunity to Conducted Disturbances Induced by Radio-Frequency Fields (Criteria A)

EN 61000-4-11:2004 Voltage Dips, Short Interruptions and Voltage Variation

Safety Standard

EN60065:2002 +A12:2011, IEC 60065:2001 Ed 7 +A1:2005 +A2:2010 Safety Requirements – Audio, Video, and Similar Electronic Apparatus

CAN/CSA 60065-03 incl. A1 Safety Requirements – Audio, Video, and Similar Electronic Apparatus

UL Std No. 60065-2007 Safety Requirements – Audio, Video, and Similar Electronic Apparatus

The product identified above conforms to the requirements of the EMC Council Directive 2004/108/EC and the Low Voltage Directive 2006/95/EC.

General Description

Introduction

The Federal Signal CTS2 Series offers new flexibility and value for installed sound. The Com-Tech Series was the first to offer independent selection of high- and low- impedance operation for a specific channel, and CTS2 Series amplifiers continue that tradition, with power levels and features carefully chosen to perfectly integrate into fixed install design requirements.

Modern power amplifiers are sophisticated pieces of engineering capable of producing extremely high power levels. They must be treated with respect and correctly installed if they are to provide the many years of reliable service for which they were designed.

In addition, CTS2 Series amplifiers include a number of features which require some explanation before they can be used to their maximum advantage.

Read this manual so that you can obtain the best possible service from your amplifier.

CTS2 Specifications

Table 1 CTS2 Specifications

Model	Channels	2 Ohms	4 Ohms	8 Ohms	70 Vrms	100 Vrms
CTS2-300	2	150 W	300 W	300 W	300 W	300 W
CTS2-600	2	300 W	600 W	600 W	600 W	600 W
CTS2-1250	2	1250 W	1250 W	1250 W	1250 W	1250 W
CTS2-300N	2	150 W	300 W	300 W	300 W	300 W
CTS2-600N	2	300 W	600 W	600 W	600 W	600 W
CTS2-1250N	2	1250 W	1250 W	1250 W	1250 W	1250 W
CTS2-2400N	2	2100 W	2400 W	1900 W	2100 W	2300 W

Features for All Models

The CTS2 has the following features:

- Exclusive Technology – The patented integrated circuit combines hundreds of discrete circuits into one chip for better performance, lower power consumption and improved reliability.
- Power Saving Modes – Power consumption in sleep mode is less than 1 W.
- Auto Standby – Amplifier goes into Sleep mode after 30 minutes of no input signal.
- Remote Power Off – Sleep mode activated via AUX port.
- 70 V/100 V Direct Drive – Each channel individually selectable for low-Z or high-Z operation.
- 100 V Direct Drive Capability – Higher voltage allows more speakers per output and reduced wiring costs.
- TLC Protection – Protects amplifier from excessive heat and maintains operation by intelligently applying gain reduction when necessary.

- Advanced Protection Circuits – Amplifier and loads are protected against shorted outputs, DC, mismatched loads, overheating, over- or under-voltage, and high frequency overload.
- Five Year, No-Fault Transferable Warranty – Your investment is fully protected.
- PFC Power Supply – the next generation power supply design guarantees minimum rated power delivered for drastically lower current draw.

Features (Network Capable Models)

The network capable models has the following features:

- BLU link Digital Audio Transport – Up to 256 Channels of digital audio over Category 5E cabling.
- Configuration in HiQnet Audio Architect™
- Programmable General Purpose Input/Output Control Port
- Priority Input Router
- Monitoring and Control over TCP/IP.
- Real time Continuous Loading Monitoring.

Front Panel Features

Indicators

Table 2 Front Panel Visual Indications

Features	Description
Fault Indicator (red)	Flashes when the amplifier output channel has stopped operating.
Thermal Indicator (red)	Illuminates when the channel reaches 80 degrees Celsius, indicating the onset of protection compression. If the temperature continues to rise, the amplifier output will shut off at 98 degrees Celsius and remain off until a safe operating temperature is present.
Clip Indicator (red)	Illuminates when any of the following conditions are present: Onset of audible clipping, clipped signal detected at input, clipped signal detected at output, engagement of protection circuits.
Level and Signal Indicators (green)	Three LEDs indicate signal presence and level as follows: -10 = 10 dB below rated output -20 = 20 dB below rated output Signal = -40 dBU input level.
Ready Indicator (green)	When this indicator is activated, the amplifier is ready to pass audio.
Power Indicator (blue)	Illuminates when the amplifier is ON and acceptable AC line voltage is present. Blinks when AC line voltage is outside ±10% range. Flashes for 4 seconds if Power button pressed when amplifier is in sleep mode.
Cooling Vent Grille	Provides cooling air flow. Do not block or cover these vents.
Bridge Mode Indicator (yellow)	Illuminates when Bridge Mode is activated for the channel pair, only odd number channel will be active.

Features	Description
Data Indicator (yellow)	Illuminates when data present on the data network only. BLU link connectivity is not a part of this indicator.
Power Button	Power Ring Indicator (Green) - Illuminates when the amplifier is plugged into a wall outlet with acceptable power. NOTE: Power Button is disabled when AUX port Sleep circuit is used.

Figure 1 Front of Amplifier

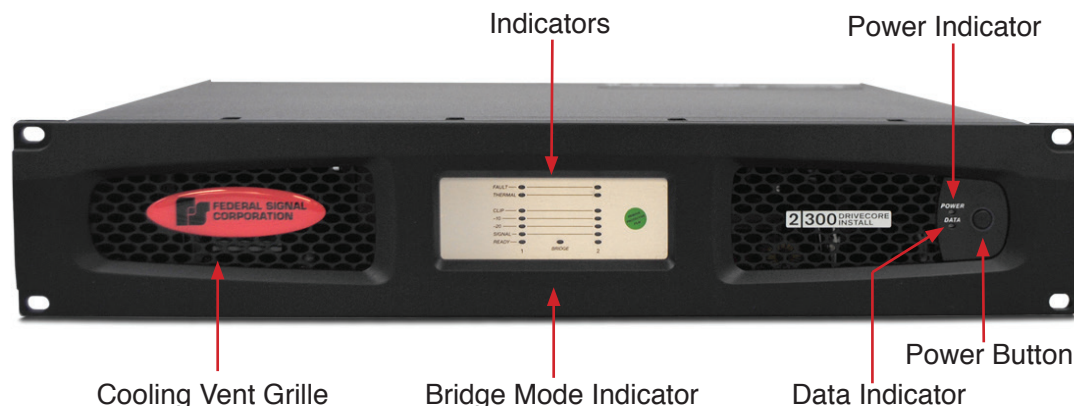

NOTE: Eight channel model shown. Indications per channel pair are identical for 2 and 4 channel models.

Back Panel Features (CTS2-300, CTS2-600, CTS2-1250)

Table 3 Back Panel Features (CTS2-300, CTS2-600, CTS2-1250)

Features	Description
Power Fuse	F20AH 250 V, replace with same type fuse. Littelfuse 314 Series.
Global Setting	Used to select 70 and 100 Vrms, amplifier status, power save.
Input Attenuators	One 21-position detented potentiometer per channel. Logarithmic audio taper. Attenuation range mute to 0 dB.
Mode DIP Switches	Used to select Hi-Z, Low-Z, or Bridged mode.
Input Connectors	One 6-pin plug-in connector per input pair. High impedance balanced.
AC Power Inlet	Standard IEC type 320 inlet for detachable connector 100 - 240 V~.
Cooling Fan Outlet	Outlets for cooling air flow. Do not block or cover these outlets.
Auxiliary Connector	3-pin plug-in type connector, enables SLEEP mode and monitoring of AMP STATUS unless the amplifier is in any of these conditions: OFF, SLEEP, or FAULT.
Output Connectors	One four-pole touch-proof terminal strip per channel pair. Accepts up to 10 AWG wire or terminal forks.

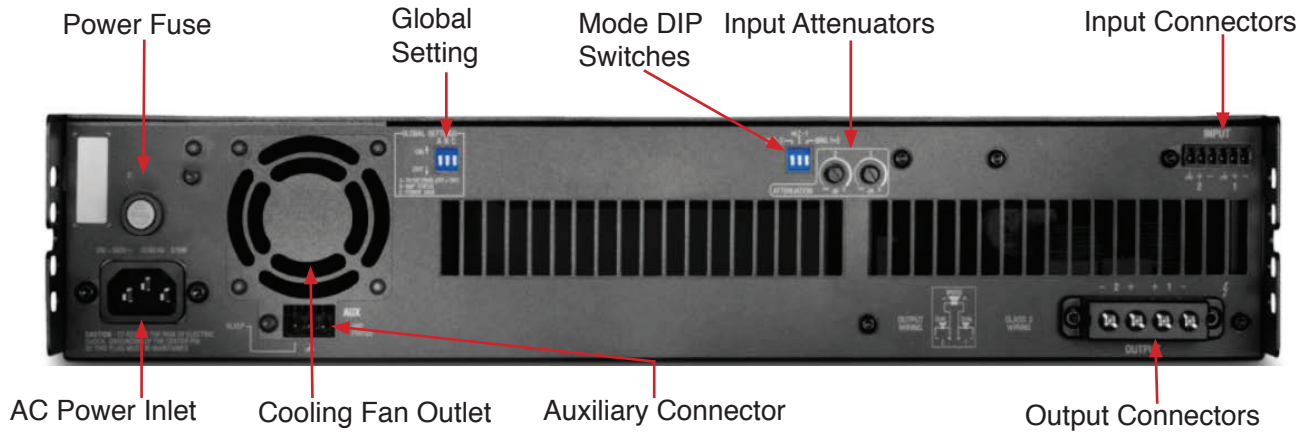

Back Panel Features (CTS2-300N, CTS2-600N, CTS2-1250N)

Table 4 Back Panel Features (CTS2-300N, CTS2-600N, CTS2-1250N)

Features	Description
Power Fuse	F20AH 250V, replace with same type fuse. Littelfuse 314 Series.
Ethernet*	For monitoring and control of the amplifier over Category 5E wiring through the Audio Architect software.
BLU link*	Input/Output Ring. Up to 256 channels of digital audio over Category 5E wiring. Only 60 nodes should be used in the BLU link Ring.
Input Attenuators	One 21-position detented potentiometer per channel. Logarithmic audio taper. Attenuation range mute to 0 dB.
Input Connectors	One 6-pin plug-in connector per input pair. High impedance balanced
AC Power Inlet	Standard IEC type 320 inlet for detachable connector 100 - 240 V~.
Cooling Fan Outlet	Outlets for cooling air flow. Do not block or cover these outlets.
Auxiliary Connector	3-pin plug-in type connector, enables SLEEP mode and monitoring of AMP STATUS unless the amplifier is in any of these conditions: OFF, SLEEP, or FAULT.
General Purpose	Input/Output (GPIO). Connect to the amplifier via RJ-11. There are two analog input controls and two digital output controls.
Output Connectors	One four-pole touch-proof terminal strip per channel pair. Accepts up to 10 AWG wire or terminal forks.

*Warning: Only connect to networks that remain inside the building.

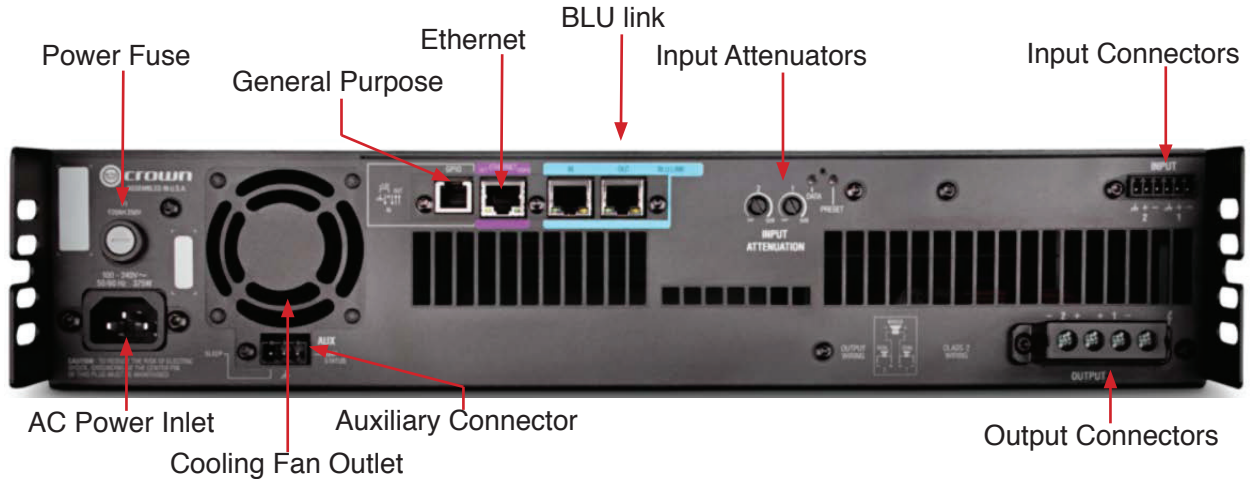

Back Panel Features (CTS2-2400N)

Table 5 Back Panel Features (CTS2-2400N)

Features	Description
Cooling Fan Outlet	Outlets for cooling air flow. Do not block or cover these outlets.
GPIO/AUX	8-pin block connector combines the 2-in, 2-out GPIO with the SLEEP and AMP STATUS pin from the AUX circuit.
Ethernet*	For monitoring and control of the amplifier over Category 5E wiring through the Audio Architect software.
BLU link*	Input/Output Ring. Up to 256 channels of digital audio over Category 5E wiring. Only 60 nodes should be used in the BLU link Ring.
Output Connectors	One four-pole touch-proof terminal strip per channel pair. Accepts up to 10 AWG wire or terminal forks.
Power Cord Connector	20 A IEC C19 connector.
Reset Switch/ Circuit Breaker	If the current draw of the amplifier exceeds safe limits, this breaker automatically disconnects the power supply from the AC mains. The switch resets the circuit breaker.
Input Connectors	One 6-pin plug-in connector per input pair. High impedance balanced.
Input Attenuators	One 21-position detented potentiometer per channel. Logarithmic audio taper. Attenuation range mute to 0 dB.

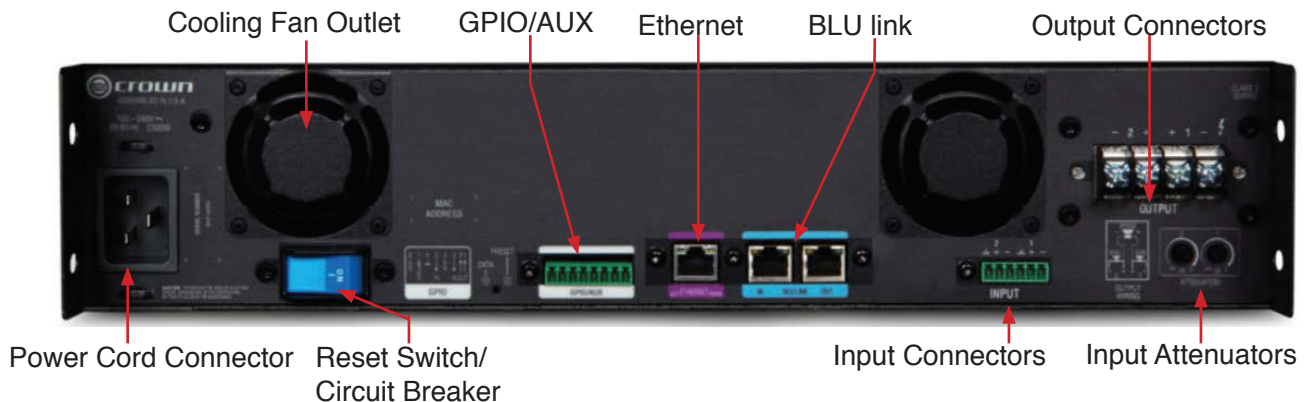

*Warning: Only connect to networks that remain inside the building.

How to Use This Manual

This manual provides you with the necessary information to safely and correctly setup and operate your amplifier. It does not cover every aspect of installation, setup or operation that might occur under every condition. For additional information, contact Federal Signal Technical Support.

We strongly recommend you read all instructions, warnings and cautions contained in this manual.

Setup

1. Unpack Your Amplifier

Unpack and inspect your amplifier for any damage that may have occurred during transit. If damage is found, notify the transportation company immediately. Only you can initiate a claim for shipping damage. Federal is happy to help as needed. Save the shipping carton as evidence of damage for the shipper's inspection.

We also recommend that you save all packing materials so you will have them if you ever need to transport the unit. Never ship the unit without the factory pack.

You Need (not supplied):

- Input wiring cables
- Output wiring cables
- Phillips screwdriver
- Rack for mounting amplifier (or a stable surface for stacking)
- Category 5E cabling (if appropriate).

⚠ WARNING

Before you start to set up your amplifier, make sure you read and observe the Important Safety Instructions found at the beginning of this manual.

2. Install Your Amplifier

⚠ CAUTION

Before you begin, make sure your amplifier is disconnected from the power source, with power switch in the off position and all level controls turned completely down (counterclockwise).

Use a standard 19-inch (48.3 cm) equipment rack. See Figure 2 for amplifier dimensions.

You may also stack amps without using a cabinet.

NOTE: When transporting, amplifiers should be supported at both front and back.

Figure 2 CTS2 Channel Series Dimensions

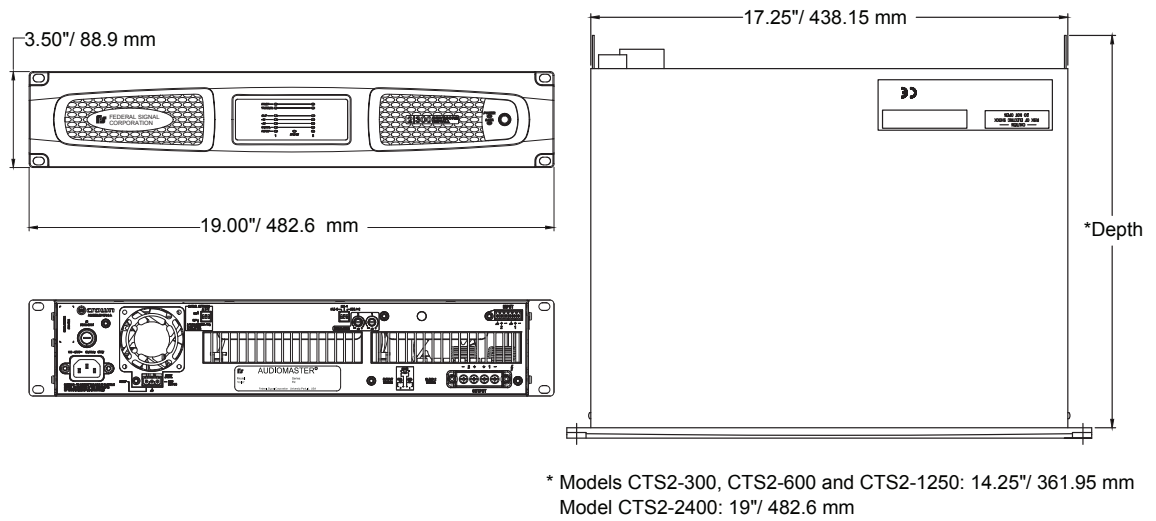

3. Ensure Proper Cooling

When using an equipment rack, mount units directly on top of each other. Close any open spaces in rack with blank panels. Do not block front or rear air vents. The side walls of the rack should be a minimum of two inches (5.1 cm) away from the amplifier sides, and the back of the rack should be a minimum of four inches (10.2 cm) from the amplifier back panel.

Figure 3 Airflow

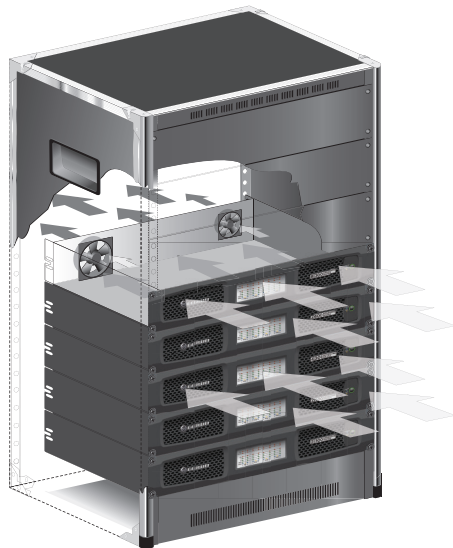

4. Choose Input Wire and Connectors

Figure 4 shows connector pin assignments for balanced wiring, and connector pin assignments for unbalanced wiring.

NOTE: Custom wiring should only be performed by qualified personnel.

Figure 4 Balance and Unbalance Input Connector Wiring

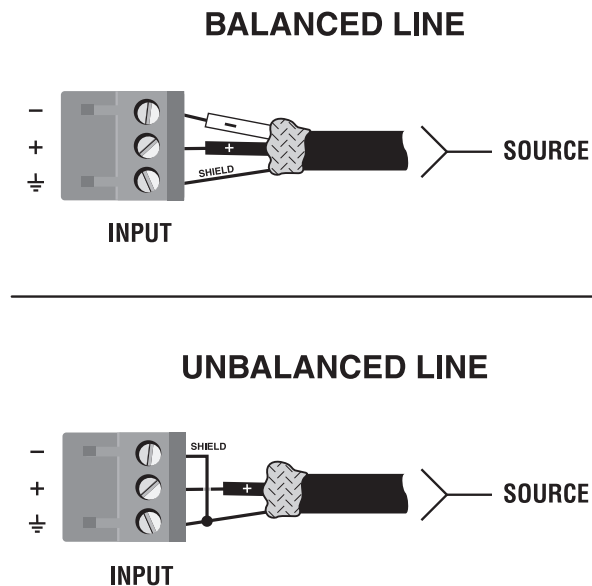

5. Choose Output Wire and Connectors

The unit is designed with an output cover that does not need to be removed to connect the output wiring.

Federal Signal recommends using the included spade connectors and two- or four-conductor, heavy gauge speaker wire. You may use terminal forks up to 10 AWG or bare wire for your output connectors (see Figure 5). For best results, Federal Signal recommends Panduit part #PV10-6LF-L or equivalent terminal fork (CTS2-2400N model require TE part #1958480-1 or equivalent). For bare wire, it is highly recommended that output wiring is tinned. To reduce strain on input and output wiring, Federal Signal recommends the use of horizontal lacer bars. For best results, Federal Signal recommends Middle Atlantic part# LBP-4R90 or equivalent horizontal lacer bar.

For low-impedance loads, select the appropriate size of wire based on the distance from amplifier to speaker.

Table 6 Wire Size Guidelines

Distance	Wire Size
up to 25 ft. (7.6m)	16 AWG
26-40 ft. (7.9-12.2m)	14 AWG
41-60 ft. (12.5-18.3m)	12 AWG
> 60 ft (18.3m)	10 AWG

⚠ CAUTION

Never use shielded cable for output wiring.

Never connect the speaker return to the chassis of the amplifier, or damage to the amplifier may result.

NOTE: Custom wiring should only be performed by qualified personnel. Class 2 output wiring is required.

Figure 5 Typical Output Connector Wiring

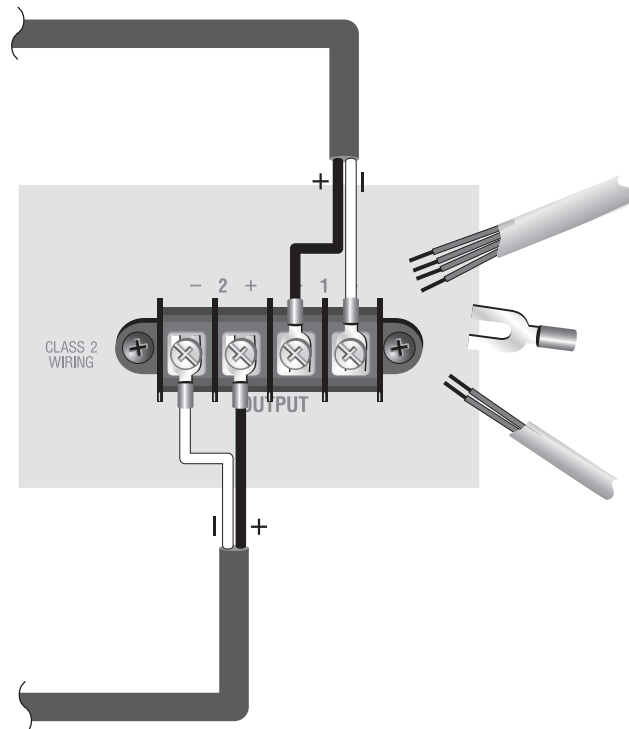

6. Per Channel Settings

The following text and illustrations refer to one channel pair, channels 1 and 2. Settings and functions are identical for other channels pairs (3/4, 5/6, 7/8) in multichannel models.

Hi-Z

Each channel of the channel pair is individually selectable for Lo-Z or Hi-Z operation. When Hi-Z operation is selected (ON, up) a 35 Hz high pass filter is selected automatically. When a channel pair is configured for bridged Hi-Z mode, only switches assigned to channel 1 are active; channel 2 is disabled.

Channel Attenuators

Each channel is supplied with a logarithmic 21-position detented input attenuator. Use a flat-blade screwdriver to set input level. Attenuation is from -95 dB (full counter-clockwise) to 0 dB (full clockwise).

Table 7 Channel Attenuators

Position	0	1	2	3	4	5	6	7	8	9	10
Typical Attenuation	0	0.1	3	6	8	9.5	11	12.5	14	15.5	16.5

Position	11	12	13	14	15	16	17	18	19	20
Typical Attenuation	17.5	19	20.5	22.5	24.5	27.5	32	42	90	95

7. Protection System

Thermal Indicator

If the amplifier becomes too hot for safe operation, the channel that is generating too much heat will be shut down until the temperature drops below the thermal limit. The front-panel thermal indicator will illuminate at 80 degrees Celsius, indicating the onset of compression affecting the audio signal. The amplifier will continue to run in this state until either the temperature is reduced to a safe operating range, or if the temperature continues to rise, the channel will shut off to protect itself above 98 degrees Celsius.

Fault

The amplifier will enter a Fault state if the amplifier senses an unsafe condition. This protection is for both internal and external faults. It is critical to check all wiring to and from the amplifier to ensure the fault is not caused by external conditions. If wiring is verified as correct and the fault condition persists, see “Getting Technical Support and Service” on page 90.

Auto Insertion High-Pass Filters

A 35 Hz high-pass filter is inserted automatically when a channel is selected for Hi-Z operation.

AC Under/Over Voltage Protection

If the AC line voltage drops below 10% or rises above 10% of the nominal operating voltage of the amplifier, the amplifier’s power supply turns off and the blue Power LED flashes. The amplifier will turn back on when the AC line voltage returns to safe operating levels.

Fuse

A fuse (F1) located near the IEC power inlet protects the amplifier from excessive AC current draw. The fuse is field replaceable. Replace with same type fuse; Littelfuse 314 Series F20AH 250 V.

Fan-cooled Chassis

CTS2 amplifiers are cooled by quiet, variable speed fans. The fans will pull air from the front of the amplifier to the rear of the amplifier.

Universal Switching Power Supply

The CTS2 incorporates a new switching power supply designed for extremely high efficiency and high output power. The supply includes Power Factor Correction (PFC), a Series Resonant Converter (SRC) and accepts AC supply voltages from 100 V~ to 240 V~. Microprocessor controlled diagnostic and control capabilities both optimize performance, and enhance long-term reliability.

8a. Setup and System Configuration (CTS2-300, CTS2-600, CTS2-1250)

Global Settings

70/100 VRMS (switch A)

This switch selects either 70 or 100 VRMS operation for all outputs currently selected for Hi-Z mode. (See the section below, Hi-Z.) Default position is 70 V (OFF). In 70 V and 100 V mode, a voltage limiter circuit is enabled. **NOTE:** When bridged Hi-Z mode is implemented, selected voltages are doubled to 140 V or 200 V.

Amplifier Status (switch B)

The Amplifier Status works with life safety or supervisory monitoring and control systems where notification of an amplifier fault is necessary. The Amplifier Status produces a signal (“heartbeat”) when the amplifier is operating within standard working parameters. If the amplifier enters a fault or thermal condition, the Amplifier Status signal will terminate. This feature is always on and available when the amplifier is ready to deliver audio in selected mode through the AMP STATUS line on the AUX port.

The Amplifier Status signal is selectable:

- ON – the microcontroller will send a 2 Hz pulse to the “AMP STATUS” AUX port line.
- OFF – the microcontroller will send a logic high level to the “AMP STATUS” AUX port line.

The voltage output of the Aux Port is 5VDC at 0.9 milliamps. This TTL or similar signal can then be connected to an interface to indicate the amplifier status to a supervisory control system.

Amp status can be used in a variety of life safety applications

Power Save (switch C)

The Power Save switch enables the Auto-Standby function. In OFF position, the Auto Standby feature is disabled; amplifier power on/off is controlled by the front panel switch or the AUX port ground closure.

In the ON position, Auto Standby is enabled. If the amplifier input does not see signal for 30 minutes, the amplifier will power down to consume less than 1W of power. When -40 dBu of input signal is applied, then the amplifier will power up for activation. The power up sequence will take approximately 4 - 5 seconds.

Connect Loudspeakers and Configure for Loudspeaker Load

Determine load impedances and power requirements

Before making any connections, carefully check and review the total impedance for loudspeaker systems to be connected to each amplifier output. If multiple loudspeakers are connected to one output (in series, parallel or series-parallel) for Lo-Z operation, be certain the total system impedance is within allowed specification for the output. When multiple loudspeakers are connected to one output for Hi-Z operation, be certain total tapped power is below the rated power output for the channel.

Dual Mode Low-Z (8, 4, or 2 Ohm)

Typical input and output wiring, along with Attenuator and Mode DIP Switch settings are shown in Figure 6. Make sure DIP Switches are in the default OFF (down) position.

INPUTS: Connect the input with wiring in place for each channel. If the same signal is to drive both outputs of a channel pair (“mono”), the signal must be split externally and applied to both inputs.

OUTPUTS: Maintain proper polarity (+/-) on output connectors. Connect the Channel 1 speaker’s positive (+) lead to amplifier Channel 1 positive terminal; repeat for negative (-). Repeat Channel 2 wiring as for Channel 1. See “5. Choose Output Wire and Connectors” on page 19.

Figure 6 System Wiring Dual Mode

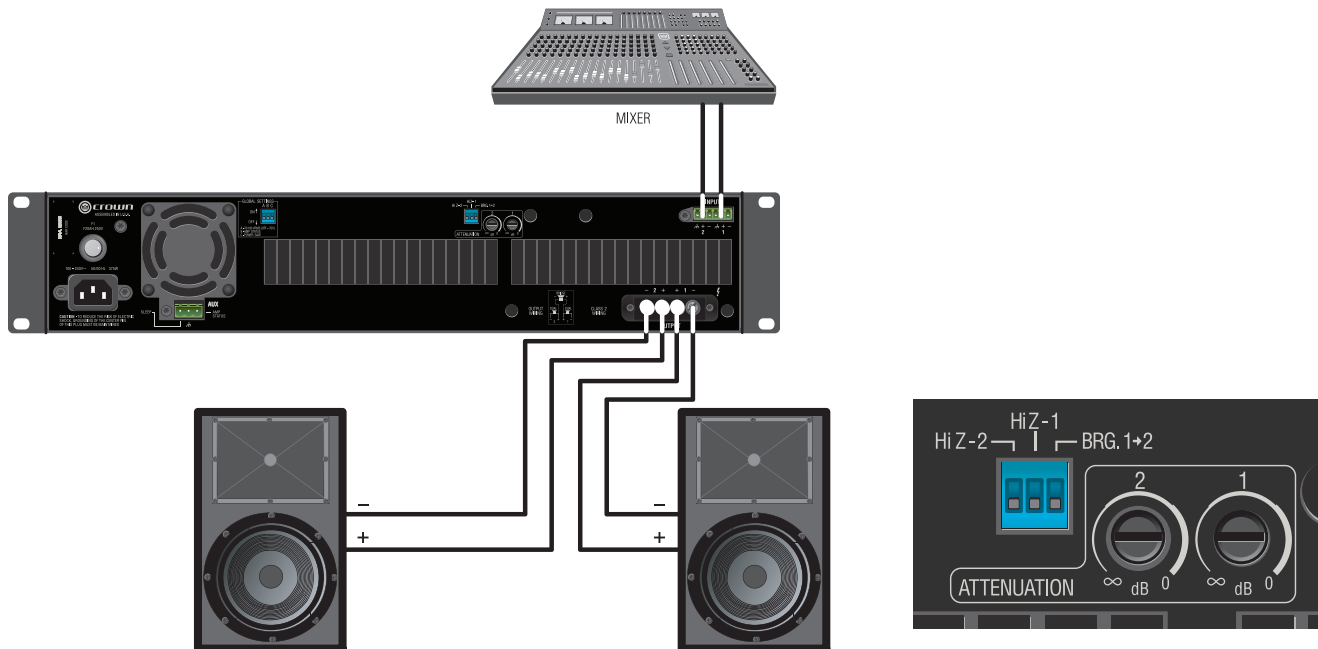

Always route the input and output wires in separate bundles.

Bridge Mode (16, 8, or 4 Ohm)

Typical input and output wiring, along with Attenuator and Mode DIP Switch settings are shown in Figure 7. Make sure the “Hi-Z” selector switches are in the OFF (down) position and the Bridge (BRG) switch is in the ON (up) position. **NOTE:** The Hi-Z selector switch affects only channel 1; channel 2 is disabled.

Figure 7 System Wiring Bridge Mode

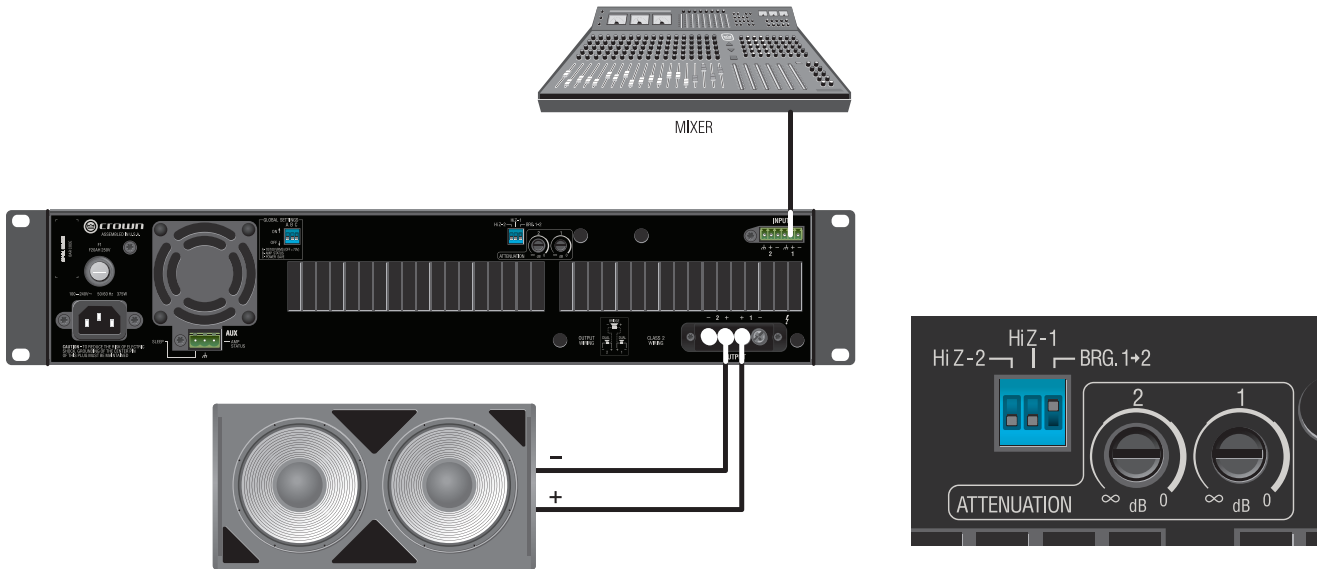

Always route the input and output wires in separate bundles.

Dual Mode Hi-Z (70V/100V)

Typical input and output wiring, along with Attenuator and Mode DIP Switch settings are shown in Figure 8. Make sure the “Hi-Z” selector switches are in the ON (up) position and the Bridge (BRG) switch is in the OFF (down) position. A 35 Hz high pass filter is selected automatically when the amplifier channel is in Hi-Z or Bridged Hi-Z mode.

NOTE: For 70 V systems, be sure that Global DIP Switch A is in the OFF position. For 100 V systems, be sure that Global DIP Switch A is in the ON position.

INPUTS: Connect the input with wiring in place for each channel. If the same signal is to drive both outputs of a channel pair (“mono”), the signal must be split externally and applied to both inputs.

OUTPUTS: Connect the outputs as shown to a Hi-Z (70V/100V) loudspeaker system.

Figure 8 System Wiring for 70V/100V Operation

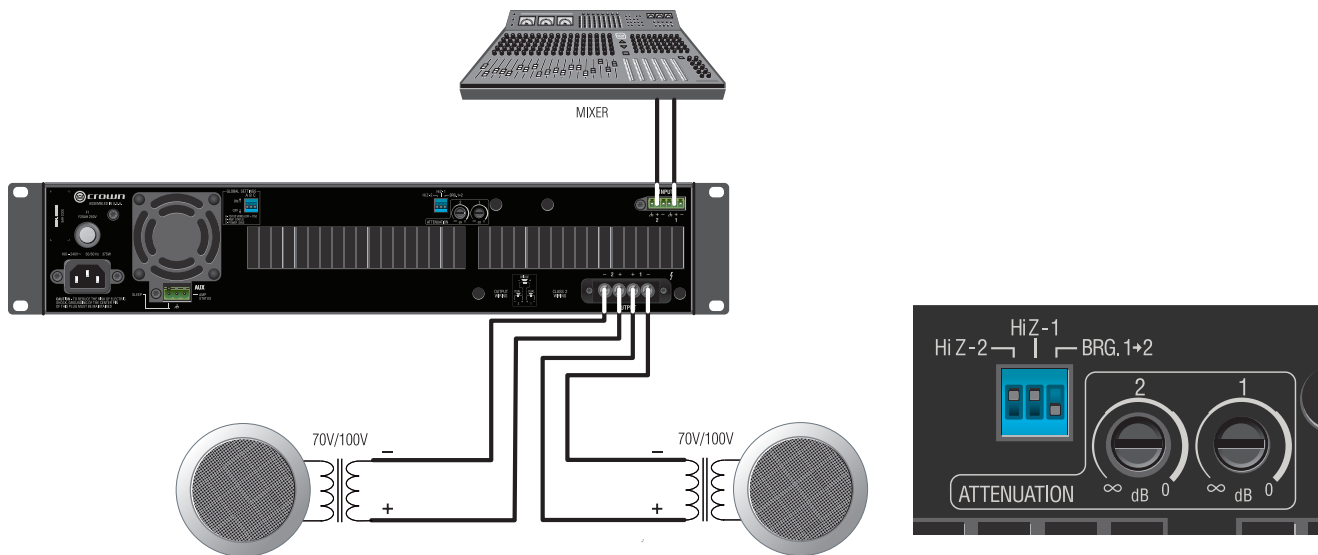

Always route the input and output wires in separate bundles.

Bridge Mode Hi-Z (140V/200V)

Typical input and output wiring, along with Attenuator and Mode DIP Switch settings are shown in Figure 9. Make sure the “Hi-Z” selector switch for the connected input channel is in the ON (up) position and the Bridge (BRG) switch for the channel pair also is in the ON (up) position. A 35 Hz high pass filter is selected automatically when the amplifier channel is in Hi-Z or Bridged Hi-Z mode. **NOTE:** The Hi-Z selector switch only affects channel 1; channel 2 is disabled.

INPUTS: Connect the input to channel 1; channel 2 is disabled when the Bridge DIP Switch is ON.

OUTPUTS: Connect the speaker across the positive terminals of each channel pair. Do not use the negative terminals of the channel pair when the pair is being operated in Bridge-Mono mode.

NOTE: For global selection of 70 V (140 V bridged) or 100 V (200 V bridged) operation, see “Global Settings” on page 22.

Figure 9 System Wiring for 70V/100V Operation

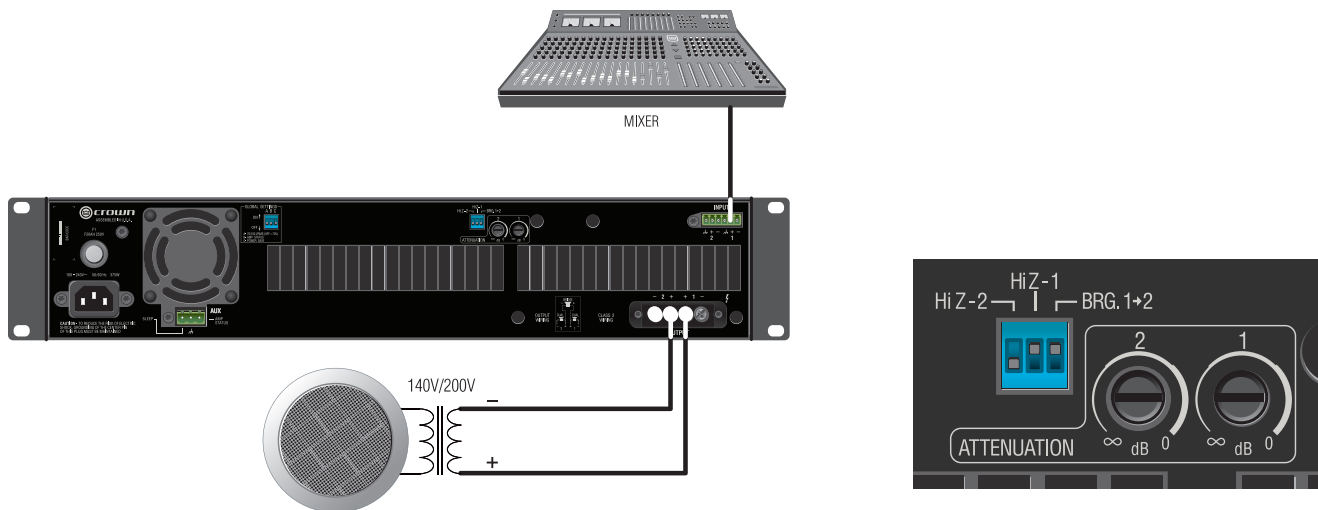

Always route the input and output wires in separate bundles.

Connect to AC Mains

Connect your amplifier to the AC mains power source (power outlet) using the supplied AC power cord set. First, connect the IEC end of the cord set to the IEC connector on the amplifier; then, plug the other end of the cord set to the AC mains.

⚠ WARNING

The third prong of this connector (ground) is an important safety feature. Do not attempt to disable this ground connection by using an adapter or other methods.

Make certain the AC mains voltage and current ratings are sufficient to deliver full power to all amplifiers. If the AC line voltage varies out of an acceptable range, the amplifier’s power supply turns off and the blue Power LED flashes. The amplifier will turn back on when the AC line voltage returns to safe operating levels.

CTS2 Amplifiers use a universal power supply. The AC voltage requirements are 100 VAC - 240 VAC, 50/60 Hz (+/-10%). If the voltage exceeds these requirements, then the Power LED will flash and the amplifier will stop passing audio until the voltage is within the requirements.

Startup Procedure

When first turning on your amplifier:

1. Turn down the level of your audio source.
2. Turn down the level controls of the amplifier to INF. See “Figure 9 System Wiring for 70V/100V Operation” on page 26.
3. Turn on the “Power” switch. The Power indicator should light.
4. Turn up the level of your audio source to an optimum level. Ensure that at no point in the signal chain is the signal being clipped in any way.
5. Turn up the level controls on the amplifier to the desired loudness or power level.

IMPORTANT: Before making any wiring or installation changes, turn off the amplifier and disconnect the power cord.

Precautions

Your amplifier is protected from internal and external faults, but you should still take the following precautions for optimum performance and safety:

1. Configure the amplifier for proper operation, including input and output wiring hookup. Improper wiring can result in serious operating difficulties. For information on wiring and configuration, see “5. Choose Output Wire and Connectors” on page 19.
2. Use care when making connections, selecting signal sources and controlling the output level. The load you save may be your own!
3. Do not short the ground lead of an output cable to the input signal ground. This may form a ground loop and cause oscillations.

⚠ CAUTION

4. Never connect the output to a power supply, battery or power main. Electrical shock may result.
5. Tampering with the circuitry or making unauthorized circuit changes may be hazardous and invalidate all agency listings.
6. Do not operate the amplifier with the RED Clip LEDs constantly flashing.

7. Do not overdrive the mixer, which will cause clipped signal to be sent to the amplifier. Such signals will be reproduced with extreme accuracy, and loudspeaker damage may result.
8. Do not operate the amplifier with less than the rated load impedance. Due to the amplifier's output protection, such a configuration may result in premature clipping and speaker damage.

Remember: Federal Signal is not liable for damage that results from overdriving other system components.

8b. Setup and Configuration (CTS2-300N, CTS2-600N, CTS2-1250N, CTS2-2400N)

Connect to AC Mains

Connect your amplifier to the AC mains power source (power outlet) using the supplied AC power cord set. First, connect the IEC end of the cord set to the IEC connector on the amplifier; then, plug the other end of the cord set to the AC mains.

⚠ WARNING

The third prong of this connector (ground) is an important safety feature. Do not attempt to disable this ground connection by using an adapter or other methods.

Make certain the AC mains voltage and current ratings are sufficient to deliver full power to all amplifiers. If the AC line voltage varies out of an acceptable range, the amplifier's power supply turns off and the blue Power LED flashes. The amplifier will turn back on when the AC line voltage returns to safe operating levels.

CTS2 Amplifiers use a universal power supply. The AC voltage requirements are 100 VAC - 240 VAC, 50/60 Hz (+/-10%). If the voltage exceeds these requirements, then the Power LED will flash and the amplifier will stop passing audio until the voltage is within the requirements.

Startup Procedure

When first turning on your amplifier:

1. Turn down the level of your audio source.
2. Turn down the input attenuators of the amplifier.
3. Turn on the "Power" switch. The Power indicator should light.
4. Turn up the level of your audio source to an optimum level. Ensure that at no point in the signal chain is the signal being clipped in any way.
5. Turn up the level controls on the amplifier to the desired loudness or power level.

IMPORTANT: Before making any wiring or installation changes, turn off the amplifier and disconnect the power cord.

Precautions

Your amplifier is protected from internal and external faults, but you should still take the following precautions for optimum performance and safety:

1. Configure the amplifier for proper operation, including input and output wiring hookup. Improper wiring can result in serious operating difficulties. For information on wiring and configuration, see “5. Choose Output Wire and Connectors” on page 19.
2. Use care when making connections, selecting signal sources and controlling the output level. The load you save may be your own!
3. Do not short the ground lead of an output cable to the input signal ground. This may form a ground loop and cause oscillations.

CAUTION

4. Never connect the output to a power supply, battery or power main. Electrical shock may result.
5. Tampering with the circuitry or making unauthorized circuit changes may be hazardous and invalidate all agency listings.
6. Do not operate the amplifier with the RED Clip LEDs constantly flashing.
7. Do not overdrive the mixer, which will cause clipped signal to be sent to the amplifier. Such signals will be reproduced with extreme accuracy, and loudspeaker damage may result.
8. Do not operate the amplifier with less than the rated load impedance. Due to the amplifier’s output protection, such a configuration may result in premature clipping and speaker damage.

Remember: Federal Signal is not liable for damage that results from overdriving other system components.

Software Setup

Connect Loudspeakers and Configure for Loudspeaker Load

Determine load impedances and power requirements

Before making any connections, carefully check and review the total impedance for loudspeaker systems to be connected to each amplifier output. If multiple loudspeakers are connected to one output (in series, parallel or series-parallel) for Low-Z operation, be certain the total system impedance is within allowed specification for the output. When multiple loudspeakers are connected to one output for Hi-Z operation, be certain total tapped power is below the rated power output for the channel.

Set Up and Configuration of the CTS2 Network amplifiers can be completed through HiQnet Audio Architect™. The amplifier should be connected to a TCP/IP network via the Ethernet connection on the back of the amplifier. **NOTE:** The BLU link digital audio transport connectors cannot be used for control and monitoring of the amplifier.

To quickly configure your CTS2 Network amplifier, connect all of the amplifiers and configuration computer to the same network.

When Audio Architect is first loaded, the software will scan the network for HiQnet devices. All devices that are discovered on the network will be found under the ADD DEVICE tab on the left hand tree menu. If the devices are not found, then the network may not be configured correctly. (See Figure 10.)

Figure 10

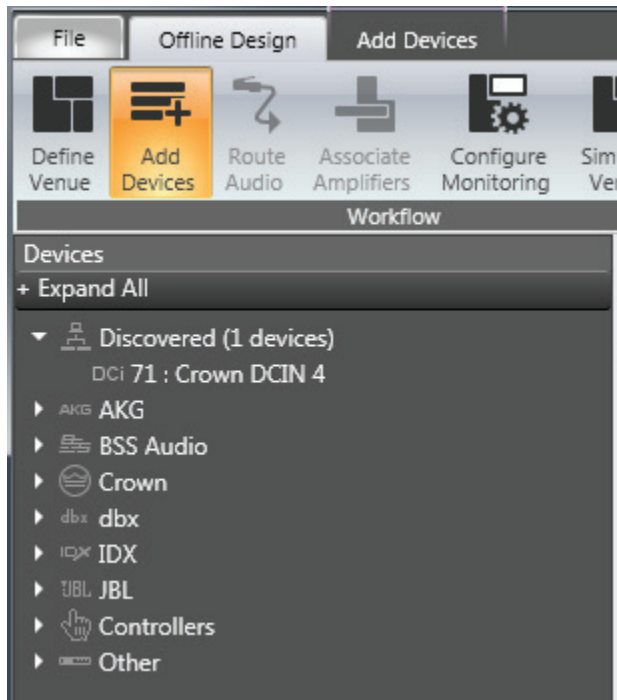

NetSetter

Introduction

The HiQnet NetSetter is a software tool which enables you to discover HiQnet devices and reconfigure network settings in real-time for each device. Its function is to configure a system of devices to interoperate correctly on the same network and resolve conflicts quickly and easily.

Figure 11 NetSetter Window

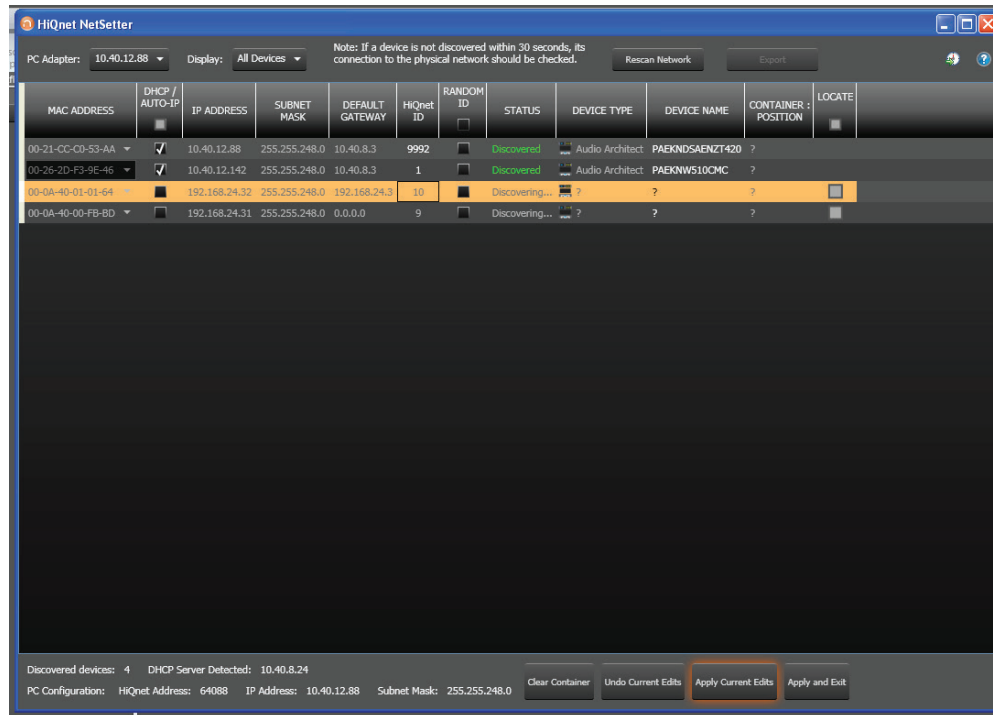

The top of the NetSetter page list overall operational functions that are available. They are as follows:

- PC Adapter – A drop list menu that selects the Network Interface Card (NIC)’s adapter that NetSetter will use to attempt to discover HiQnet devices. All available NIC’s are listed by IP Address. Selecting a new NIC will force a rescan of the network to which the new NIC is connected.
- Display – This menu filters the device in the grid view by:
 - All Devices – Default setting. All discovered devices are displayed
 - HiQnet ID conflicts – Only discovered devices with HiQnet address conflicts are displayed.
 - IP address conflicts – Only discovered devices with IP address conflicts are displayed.
 - All conflicts – Only discovered devices with either HiQnet address conflicts or IP address conflicts are displayed.
 - Locked – Only devices in a Locked configuration.

- Discovering – Only devices in the process of being discovered.
- Discovered – Discovered devices with no conflicts.
- DHCP / Auto IP – All devices which have been discovered with DHCP/Auto-IP enabled and those which have been set to use DHCP/Auto-IP on applying the edits
- Rescan Network – Clicking this button re-scans the network to which the currently selected NIC is connected.
- Export – The export button brings up a “Save As” window allowing you to save the HiQnet Addresses and IP Configurations of all devices on the network to a .CSV (Comma Separated Values) format. This allows you to archive the information and open it in a spreadsheet program such as Microsoft Excel.

At the bottom of the NetSetter window is an informational section that list the amount of discovered devices and the IP address of the DHCP Server. There is also information regarding the PC HiQnet Address, IP Address, and Subnet Mask. There are four buttons that perform the following functions:

- Clear Container – Resets the Container / Position Venue data of the selected device. The action occurs on either Apply Current Edits or Apply and Exit so that changes may be undone with the Undo Current Edits button.
- Undo Current Edits – Resets any open edits in the grid to the values as currently on the network.
- Apply Current Edits – Confirms any open edits in the grid. Devices update accordingly until connection is reestablished with HiQnet NetSetter
- Apply and Exit – Confirms and saves any open edits in the grid. The devices update accordingly until connection is reestablished with HiQnet.

Exit HiQnet NetSetter – If you have made changes to NetSetter, and attempt to exit the program the following window will appear.

Figure 12

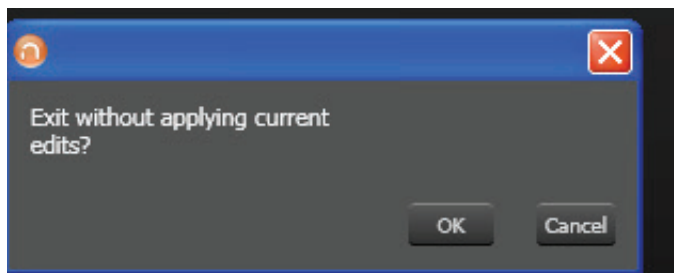

Clicking “OK” will apply the edits you have made since opening NetSetter.

Clicking “Cancel” will return you to the program.

The NetSetter Grid

The grid is divided into 12 sections:

1. MAC Address
2. DHCP/Auto-IP check box
3. IP Address
4. Subnet Mask
5. Default Gateway
6. HiQnet ID
7. Random ID check box
8. Status
9. Device Type
10. Device Name
11. Container : Position
12. Locate

MAC Address

Displays the MAC Address(es) of the discovered device.

If more than one MAC Address is discovered for a single device (HiQnet device MAC Address / AVB card MAC Address etc), the field is represented as a drop list. You may select between the connected MAC Addresses.

The data in this field cannot be edited.

- For a device connected to the same control network with two control MAC Addresses, the MAC Address field will be displayed in red.

DHCP/Auto-IP

If the discovered device is set to use DHCP/Auto-IP, the check box will be checked. If the discovered device is not using DHCP/Auto-IP, you may check the box so it will do so on applying edits. The device row will then become selected. The device will attempt to have its IP settings configured by DHCP on applying the edits, if no DHCP server is present the device will attempt to have IP settings configured by Auto-IP.

All devices in the current filter view may be set to DHCP/Auto-IP on by checking the check box in the column header. The individual check boxes for all devices will be checked. If a single individual check boxes for all devices is subsequently unchecked the column header DHCP/Auto-IP check box will be automatically unchecked.

The devices in the current filter view may be set to DHCP/Auto-IP off by unchecking the check box in the column header.

DHCP server status will be among the information displayed at the bottom of the window. If a DHCP server is not detected, the information will read ‘DHCP server not detected’ Checking a device’s DHCP/Auto-IP check box has no immediate effect on the column sort order. Once edits have been made, it is critical to click the “Apply Current Edits” or “Apply and Exit” buttons.

IP Address

Displays the IP address of the discovered device

A valid IP address may be edited inline. If the edited value scopes the device out of the current Display filter, it will not be visible.

Devices discovered with a conflicting IP Address

A discovered device with an IP Address that conflicts with one that has already been discovered will be displayed in red. A conflicting IP Address may be edited inline if you wish to change the device IP Address on applying current edits.

If DHCP / Auto-IP is enabled the IP address field may not be edited inline. Once edits have been made, it is critical to click the “Apply Current Edits” or “Apply and Exit” buttons.

Subnet Mask

Displays the Subnet Mask of the discovered device.

The Subnet Mask may be edited inline.

- The device row will be ordered accordingly with the current column sort immediately on successful editing of the field
- The device row will remain selected

If DHCP / Auto-IP is enabled the Subnet Mask field may not be edited inline. Once edits have been made, it is critical to click the “Apply Current Edits” or “Apply and Exit” buttons.

Default Gateway

Displays the Default Gateway of discovered device.

May be edited inline.

- The device row will be ordered accordingly with the current column sort immediately on successful editing of the field
- The device row will remain selected

If DHCP / Auto-IP is enabled the Default Gateway field may not be edited inline. If the device is being rediscovered then:

- When the device is not selected, the device Default Gateway address field is displayed but is grayed out, represented in light gray.
- When the device is selected and highlighted in orange the field is represented in dark gray.

Once edits have been made, it is critical to click the “Apply Current Edits” or “Apply and Exit” buttons.

HiQnet ID

Displays the HiQnet address of the discovered device.

May be edited inline if you want to change the device HiQnet address.

If the edited value scopes the device out of the current Display filter, it will not be visible. No devices will be selected.

If devices discovered with a conflicting HiQnet Address then:

- The HiQnet ID field of a discovered device with a HiQnet Address which conflicts with a HiQnet Address which has already been discovered will be displayed in pink.
- A conflicting HiQnet Address may be edited inline if you want to change the device HiQnet Address.
- When the device is selected and highlighted in orange the field is represented in red.
- The HiQnet address is not displayed, instead a dash is displayed as grayed out.

Devices not discoverable at the IP level

A device which is not discoverable at the IP level (invalid IP address etc) will not be able to report a HiQnet address. In this instance, the HiQnet ID field will display a “?” to indicate that the field may exist but that the software does not have enough discoverability of the device to determine the value. A blank field or ‘-‘ implies the value is null. The HiQnet ID field may not be edited inline. Once edits have been made, it is critical to click the “Apply Current Edits” or “Apply and Exit” buttons.

Random ID

The device will be given a random HiQnet address. If you want to set the HiQnet address of a device to a random ID, check the Random ID check box. If the check box is unchecked before applying current edits, the prior HiQnet ID value will be restored.

All devices in the current filter view may be set to Random HiQnet ID by checking the check box in the column header. The individual check boxes for all devices will be checked if a single individual check boxes for all devices is subsequently unchecked the column header Random ID check box will be automatically unchecked.

If all devices in the current filter view are set to Random ID on and the Random HiQnet ID column header check box is checked, all devices may be set to Random ID off by unchecking the column header check box. The individual check boxes for all devices will be unchecked.

Devices not discoverable at the IP level

A device which is not discoverable at the IP level (invalid IP address etc) will not be able to report a HiQnet address. In this instance, the Random ID check box will be unavailable.

Status

Displays the current discovery status of the device. The Status field may not be edited. Discovery status hierarchy is as follows:

- **Discovered.** If a device has a unique IP address and a unique HiQnet address, this condition will be shown unless the device is access controlled. When the device is not selected, the 'Discovered' label is represented in green.
- **IP conflict.** If a device has an IP Address conflict, this error will be shown regardless of other status notifications. When the device is not selected, the 'IP conflict' label is represented in blue.
- **HiQnet conflict.** If a device has a unique IP address yet has a HiQnet address conflict, this error will be shown regardless of other status notifications. When the device is not selected, the 'HiQnet conflict' label is represented in red.
- **Locked.** If a device has a unique IP address and a unique HiQnet address, this condition will be shown if the device is access controlled. When the device is not selected, the 'Locked' label is represented in yellow.
- **Discovering.** This condition will be displayed if the device has had changes made to IP configuration or HiQnet address and HiQnet NetSetter is waiting to reestablish connection. When a device being rediscovered is not selected, all fields within the device row are displayed but is grayed out, represented in light gray.

Discovered

The 'Discovered' status is determined by the following conditions:

- The device is discoverable at the MAC Address level
- The device has a valid and unique IP Address (manual or DHCP / Auto-IP)
- The device has a unique HiQnet address
- The device is not Access Controlled

IP conflict

The 'IP conflict' status is determined by the following conditions:

- The device is discoverable at the MAC Address level
- The device has an IP address which conflicts with another device which has already been discovered by NetSetter

HiQnet conflict

The 'HiQnet conflict' status is determined by the following conditions:

- The device is discoverable at the MAC Address level
- The device has a valid and unique IP Address (manual or DHCP/Auto-IP)
- The device has a HiQnet address which conflicts with another device which has already been discovered by NetSetter

Locked

The 'Discovered' status is determined by the following conditions:

- The device is discoverable at the MAC Address level
- The device has a valid and unique IP Address (manual or DHCP / Auto-IP)
- The device has a unique HiQnet address
- The device is Access Controlled

When the device has been discovered in the Locked state, a dialog must be displayed to prompt for the Admin password the first time any field is attempted to be edited

- A successful login with the Admin password only will enable all fields to be edited subsequently
- This state may need to be reset on rediscovery after applying current edits, requiring the Admin password to be entered again

Discovering

The 'Discovering' status is determined by the following conditions:

- The device had been previously discovered at least the MAC Address level
- Edits had been made to one or more fields
- The device is being rediscovered after applying current edits.

Since the sort order automatically updates when a field within the sorted column is updated, the rediscovered device will occupy the same row on rediscovery. Unless DHCP/Auto-IP or Random ID has been set prior to applying current edits, in which case the rediscovered device will occupy the appropriate row in the current column sort order.

Device Type

The device class name is displayed, as reported by the discovered device. To the left of each device class name is displayed the brand icon. The software application name is displayed for discovered PCs running an instance of HiQnet software:

- System Architect
- Performance Manager
- London Architect

The Device Type field may not be edited inline

Devices not discoverable at the IP or HiQnet level

A device which is not discoverable at the IP level (invalid IP address etc.) or HiQnet address level (HiQnet address conflict etc) will not be able to report its class name. In this instance, the Device Type field will display a '?' to indicate that the field may exist but that the software does not have enough discoverability of the device to determine the value.

A blank field or '-' implies the value is null.

Device Name

The user-definable Device Name is displayed, as reported by the discovered device

- May be edited inline if you want to change the Device Name.
- May not be edited for discovered PCs running an instance of HiQnet software.

Devices not discoverable at the IP or HiQnet level

A device which is not discoverable at the IP level (invalid IP address etc) or HiQnet address level (HiQnet address conflict etc) will not be able to report its Device Name. In this instance, the Device Name field will display a '?' to indicate that the field may exist but that the software does not have enough discoverability of the device to determine the value

A blank field or '-' implies the value is null.

Once edits have been made, it is critical to click the "Apply Current Edits" or "Apply and Exit" buttons.

Container : Position

The Container and Position Venue Data is displayed (separated by a colon), as reported by the discovered device. The field is left blank for discovered PCs running an instance of HiQnet software.

- System Architect
- Performance Manager
- London Architect

The Container / Position Venue Data may not be edited inline.

A selected device may have its Venue Data cleared (including all Building, Floor and Room Venue data) by pressing the Clear Container button. This action takes place on applying current edits only and can be undone with the Undo Current Edits button

Devices not discoverable at the IP or HiQnet level.

A device which is not discoverable at the IP level (invalid IP address etc) or HiQnet address level (HiQnet address conflict etc) will not be able to report its Device Name. In this instance, the Device Name field will display a '?' to indicate that the field may exist but that the software does not have enough discoverability of the device to determine the value.

A blank field or '-' implies the value is null.

Locate

Clicking in the Locate column for a device will put the corresponding device on the network into a Locate state, and the Locate icon will be displayed.

- Clicking an active Locate icon will disable the Locate state for the device
- Disabling the Locate state from the device will clear the icon
- Devices may be put into Locate state independently from selection so that more than one device can be located at any one time

Offline/Online

Audio Architect has two define modes of operation: Online and Offline. Offline operation allows the system to be configured without real time changes to the system. In this mode, changes have to be sent to the edited device. In Online mode, changes to amplifiers are made real time.

When Audio Architect first opens, the Offline Design Tab is the ribbon presented, and the Device Toolbox appears on the left and an empty Properties window is at the bottom. The Add Devices box is highlighted. When going Online, it may be necessary to Match Devices and/or Synchronize Venue.

Figure 13 Offline Device Tab

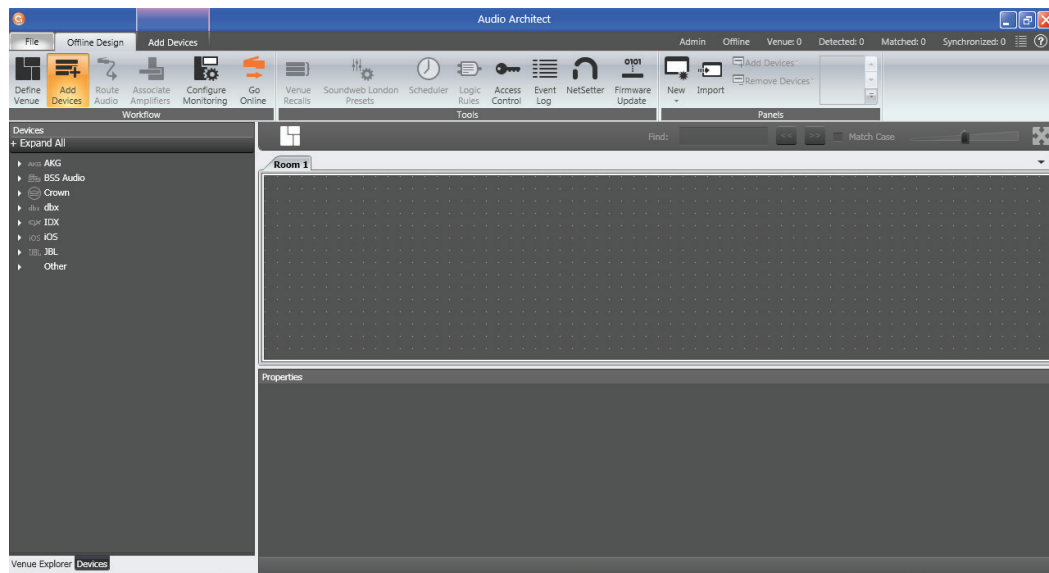

Match Devices allows users to associate amplifiers within their venue design to amplifiers on the network. In the Match Devices tab, the following options are available:

Figure 14 Add Device

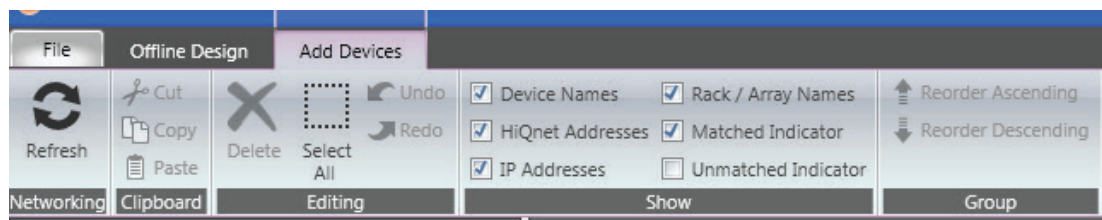

- Refresh Networking: Clicking this button will temporarily take Audio Architect offline, then restart the network.
- Match
 - Auto-Venue: Automatically enables matching between all the devices in the Audio Architect venue.
 - Detach: Removes the device’s virtual connection from Audio Architect.

- Editing
 - Undo: Erases the last change done, reverting to the previous state.
 - Redo: Re-establishes the previous state.
- Show: The checked items are displayed along side the appropriate devices in the venue; Device Names, Rack/Array Names, HiQnet Addresses, and IP Addresses. In Synchronize Venue, each device will be shown with either a Receive icon or a Send icon.
- Receive – device settings will be downloaded to the Audio Architect.
- Send – device setting will be sent from Audio Architect to the device.

When going Online, the following options are possible:

1. If one or more devices in the Venue are not matched AND corresponding devices are available on the network, going online lands in Match Devices mode.
2. If all the devices in the Venue are matched, going online lands in Synchronize Venue mode. In Synchronize Venue mode, the user is given the option to either Send data from Audio Architect to the device or Receive data from the device to Audio Architect.
3. If no devices require to be synced, going online lands in Run Venue mode.

Each amplifier can be dragged into the room window. Each device will have a IP address listed on the left of the amplifier and a Name ID on the right on the amplifier. The Name ID can be edited in the properties menu at the bottom of the page. The number to the left of Name ID is the HiQnet Device Address. The green circle only indicates that the amplifier has been discovered on the network. The small box located below the rack allows quick access to amplifier factory panels. These panels include the following items. **NOTE:** When a device is added to the window, it is automatically removed from the “Discovered” section.

- Factory Master Panels
- Monitor Panels
- Meter Panels
- Level and Mute Panels

Figure 15 Going Online Mode

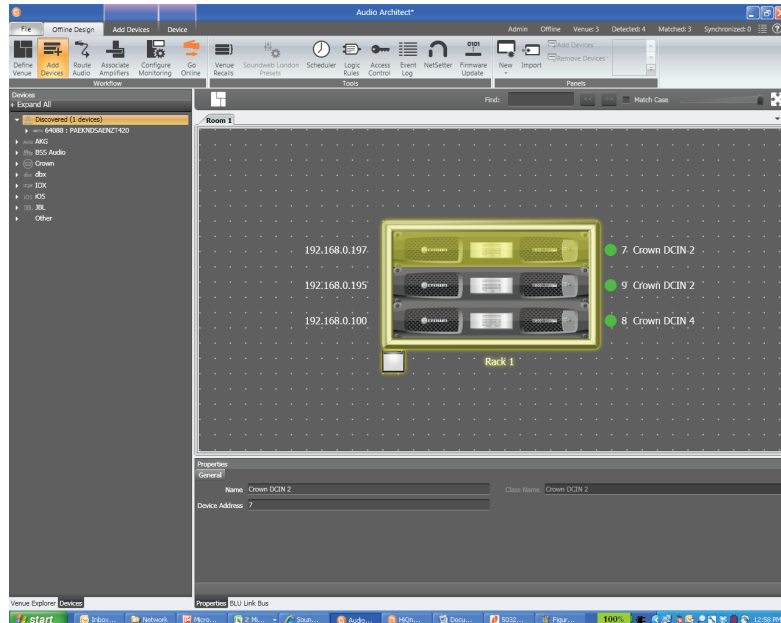

Double clicking an amplifier will access the amplifier factory control panel. At this point, Audio Architect is in OFFLINE MODE. In OFFLINE MODE, amplifier changes are not made in real time and will need to be sent to the amplifiers. Amplifier changes can also be sent in real time in ONLINE MODE. To go to ONLINE MODE, click on the GO ONLINE tab in the Workflow bar menu. RECEIVE and SEND buttons will appear for each device, rack, and room in the design. This gives the user the option to just update a single device, all devices in a rack or an entire venue. Click SEND to load the settings made in Audio Architect to the amplifier. Click RECEIVE to read the settings off of the amplifier to be reflected in Audio Architect.

Figure 16 Amplifier Factory Control Panel

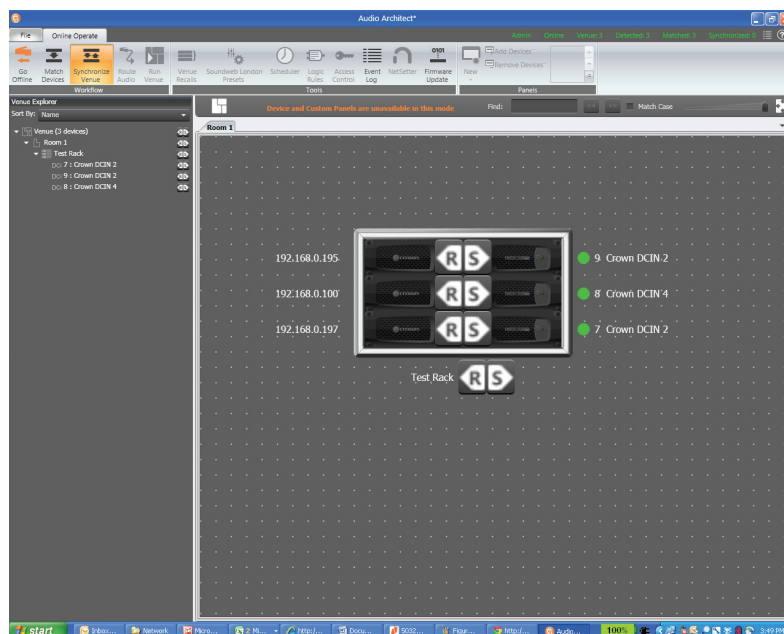

Setup and System Configuration

Figure 17 Amplifier DSP Functions

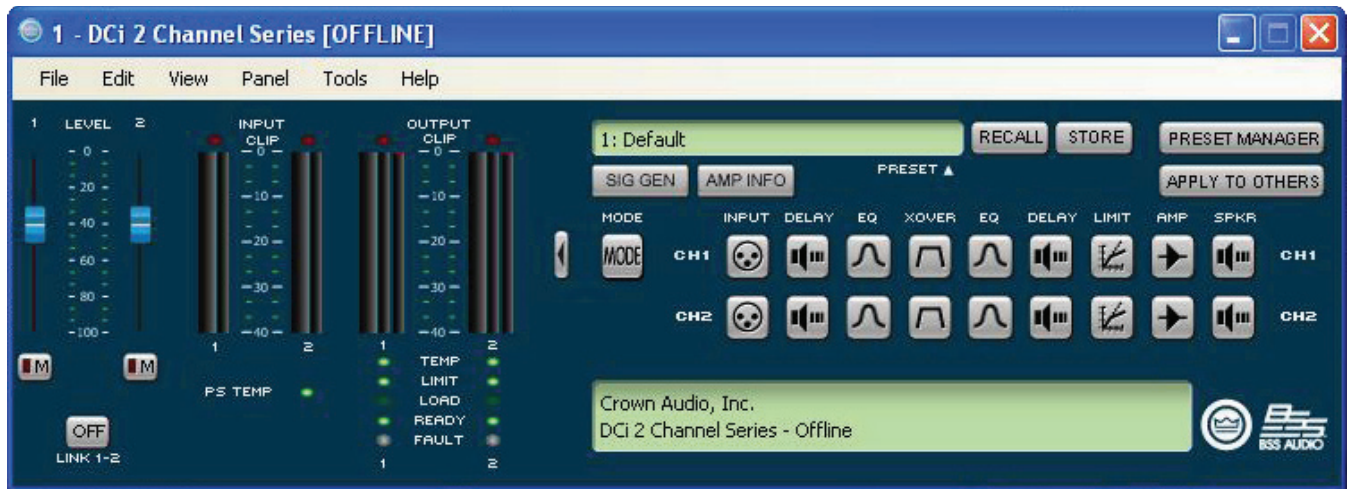

Figure 17 (above) shows the Install 2 channel configuration page. The 4 and 8 channel amplifier configuration pages have the same feature set. The Install Network amplifier includes Digital Signal Processing (DSP), multiple input/output routing options and a comprehensive diagnostics feature set. All of these features can be adjusted in from the configuration page.

The Install amplifiers are very capable and flexible amplifiers. In the Amplifier Mode Setting window, the following items can be adjusted.

- Hi-Z/Low-Z on an individual channel basis.
- 70 Vrms or 100 Vrms operation.
- Any analog input can be sent to any amplifier output.
- Mono Bridge Output - Output pairs can be bridged for mono operation.

Hi-Z/Low-Z

The CTS2 Network amplifiers are capable of High Z and Low Z outputs. Each individual channel is capable of Hi-Z or Low-Z operation. To select Hi-Z or Low-Z operation, double click on the mode button, the Amplifier Mode Setting Window will open (see Figure 20). **NOTE:** Choosing 70 Vrms or 100 Vrms is an amplifier global setting, and affects all output channels selected for High-Z operation.

Figure 18 Amplifier Mode Settings: Hi-Z and Low-Z

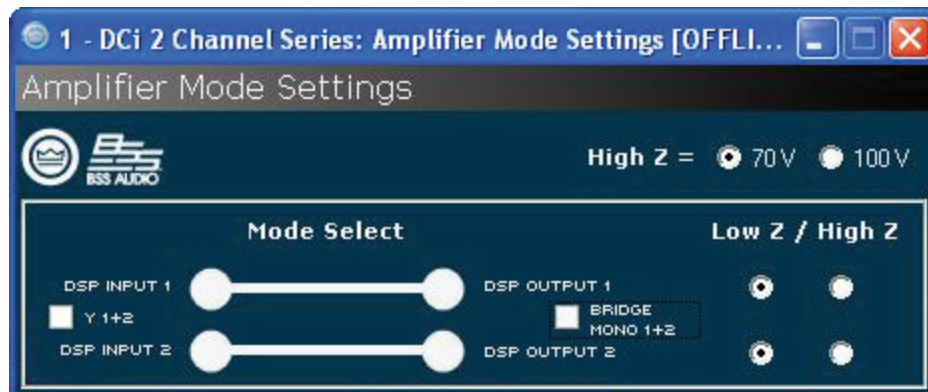

Cascading Inputs

Cascading the analog inputs, or “Y-ing channels”, gives more flexibility to the installation of this amplifier (See Figure 19). One input can be used to drive some or all of the amplifier outputs. **NOTE:** By cascading the inputs, the corresponding input DSP functions for individual channels will be removed and only the output DSP functions will be available (See Figure 20).

Figure 19 Amplifier Mode Settings: Cascading

Use the “Y 1+2” etc. check boxes to cascade channel inputs

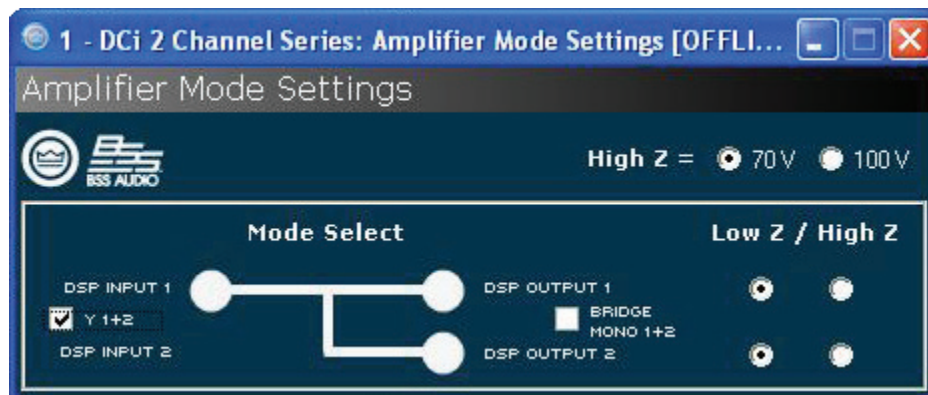

Figure 20 Amplifier DSP Functions: Cascading

With the “Y 1+2” box checked, both output Ch.1 and Ch.2 are fed by input Ch.1 and input processing is organized accordingly.



Bridge Mono Operation

The CTS2 amplifier outputs can be bridged to increase the power and voltage available at the output of the amplifier. The amplifier can be bridged in the Amplifier Mode window. By selecting the bridging option, only the first input channel will need to be wired. (See Figure 21). Low-Z and High-Z options are still available.

NOTE: If the amplifier output is in bridge mono and the High-Z option is selected, the amplifier will produce 140 Vrms or 200 Vrms.

Figure 21 Amplifier Mode Setting: Bridge Mono

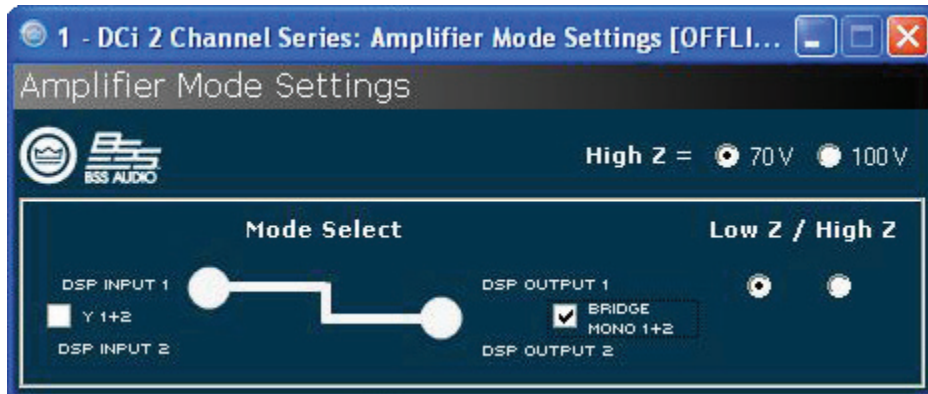

Figure 22 Amplifier DSP Functions Setting: Bridge Mono



NOTE: By selecting Mono Bridge output, only one channel in the channel pair DSP will be available (See Figure 21).

Low-Z (8Ω, 4Ω or 2Ω) Output Operation

Typical input and output wiring, along with Audio Architect software settings are shown in Figure 23.

INPUTS: Connect the input with wiring in place for each channel. If the same signal is to drive both outputs of a channel pair (“mono”), the input signal can be sent to adjacent amplifier channels. If using the BLU link input, it is important to understand that BLU link is a digital audio bus and cannot be routed through a network switch or router. To increase fault protection, use both the input and output BLU link wiring connection. For BLU link routing, see “BLU link” on page 57.

OUTPUTS: Maintain proper polarity (+/–) on output connectors. Connect the Channel 1 speaker’s positive (+) lead to amplifier Channel 1 positive terminal; repeat for negative (–). Repeat Channel 2 wiring as for Channel 1, and for any subsequent channel pairs on multichannel models. See “5. Choose Output Wire and Connectors” on page 19 for output connector terminal assignments.

Figure 23 System Wiring Dual Mode

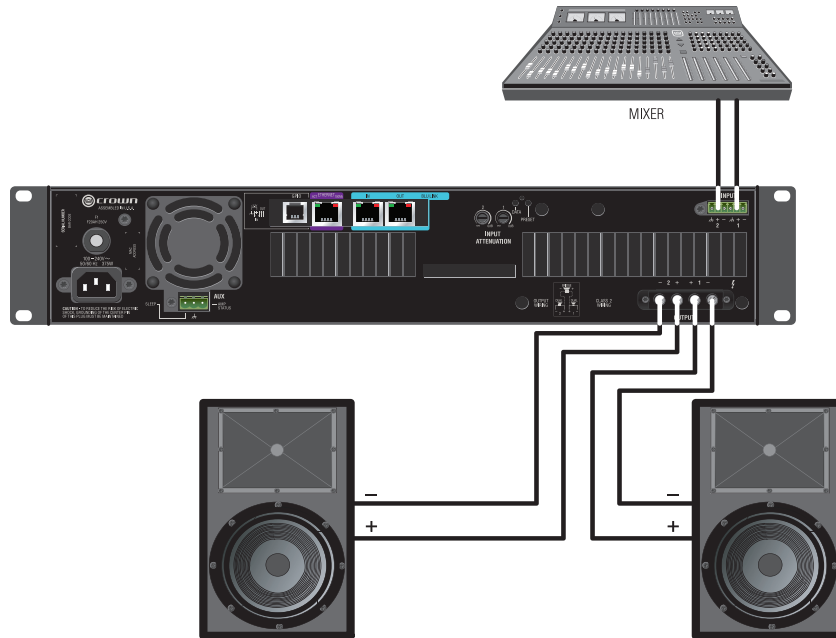
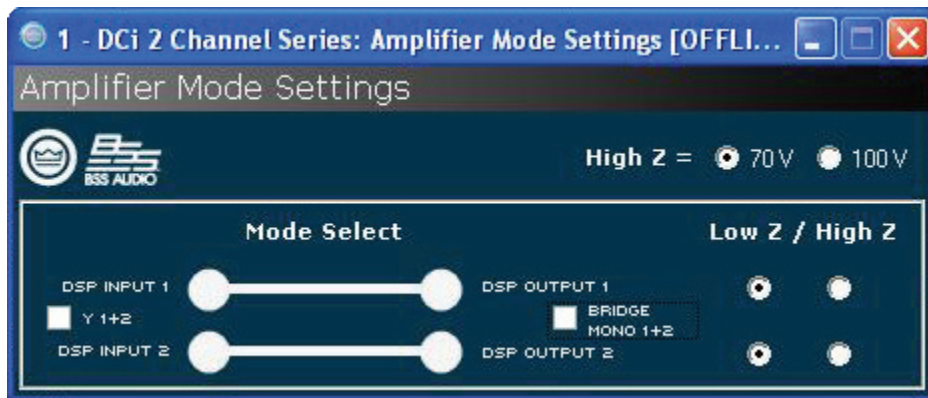

Figure 24 Amplifier Mode Setting-Low-Z



Always route the input and output wires in separate bundles.

Bridge Mode (16Ω, 8Ω, or 4Ω) Output Operation

Typical input and output wiring, along with software settings are shown in Figure 25.

INPUT WIRING: If using analog inputs, it is only necessary to wire the odd number inputs. If using the BLU link input, it is important to understand that BLU link is a digital audio bus and cannot be routed through a network switch or router. To increase fault protection, use both the input and output BLU link wiring connection. For BLU link routing, see “BLU link” on page 57.

OUTPUTS: Connect the speaker across the positive terminals of each channel pair. Do not use the negative terminals of the channel pair when the pair is being operated in Bridge Mono mode.

Figure 25 System Wiring Bridge Mode



Figure 26 Amplifier Mode Setting-Bridge Mode

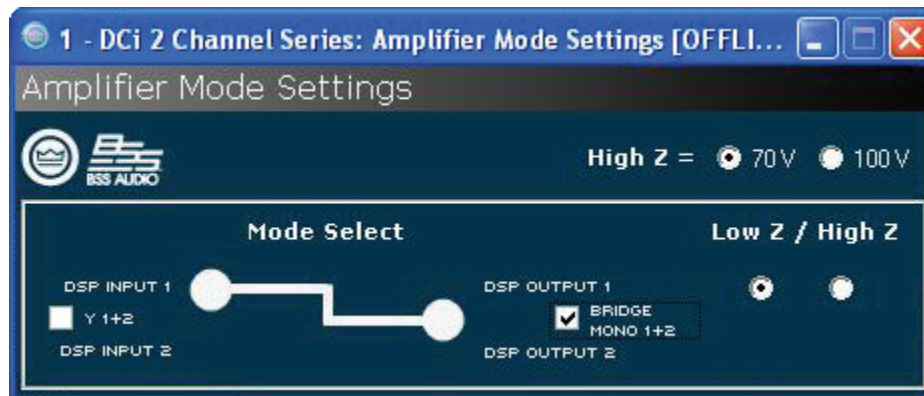

The bridge mono check box must be checked for proper operation. Always route the input and output wires in separate bundles.

Dual Mode Hi-Z (70 Vrms/100 Vrms) Mode

Typical input and output wiring, along with software settings are shown in Figure 27. A 35 Hz high pass filter is selected automatically when the amplifier channel is in Hi-Z or Bridged Hi-Z mode. Remember, CTS2 amplifiers allow each channel Hi-Z or Low-Z mode of operation to be selected independently, while 70 Vrms/100 Vrms selection is global.

Figure 27 System Wiring for 70 Vrms/100 Vrms Operation

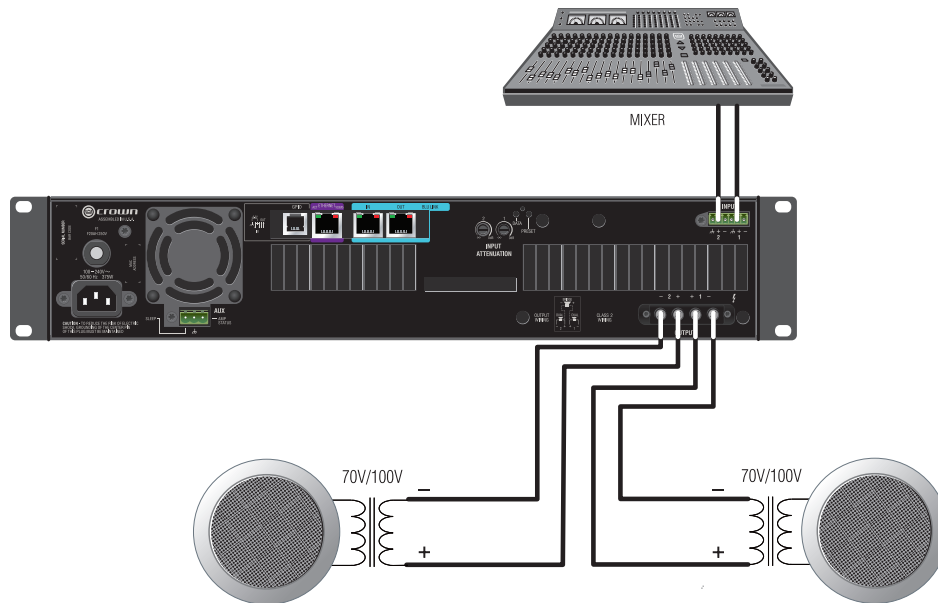
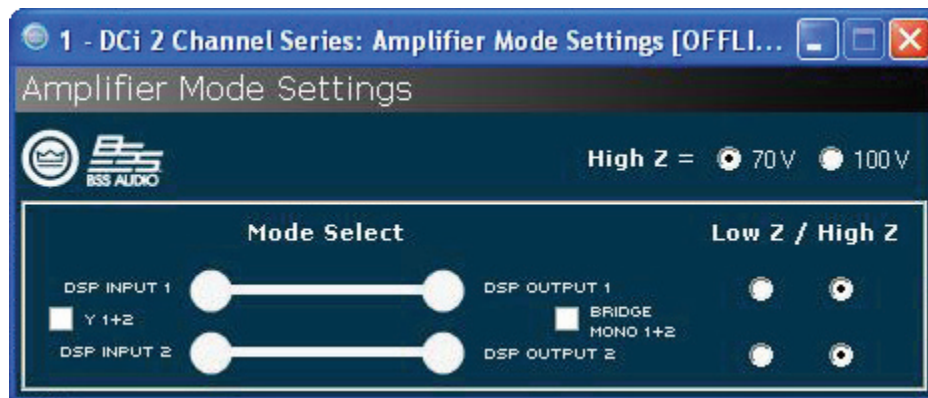

Figure 28 Amplifier Mode Settings-Dual Mode Hi-Z



NOTE: 70 Vrms/100 Vrms is global, while Low-Z/Hi-Z is per output channel.

Always route the input and output wires in separate bundles.

Bridge Mode Hi-Z (140 Vrms/200 Vrms)

INPUTS: Connect the input to channel 1 only. Channel 2 is disabled when the Bridge Mono mode is active.

OUTPUTS: Connect the speaker across the positive terminals of each channel pair. Do not use the negative terminals of the channel pair when the pair is being operated in Bridge Mono mode.

NOTE: For global selection of 70 Vrms (140 Vrms bridged) or 100 Vrms (200 Vrms bridged) operation, see page 49.

Figure 29 System Wiring for 140 Vrms/200 Vrms Operation

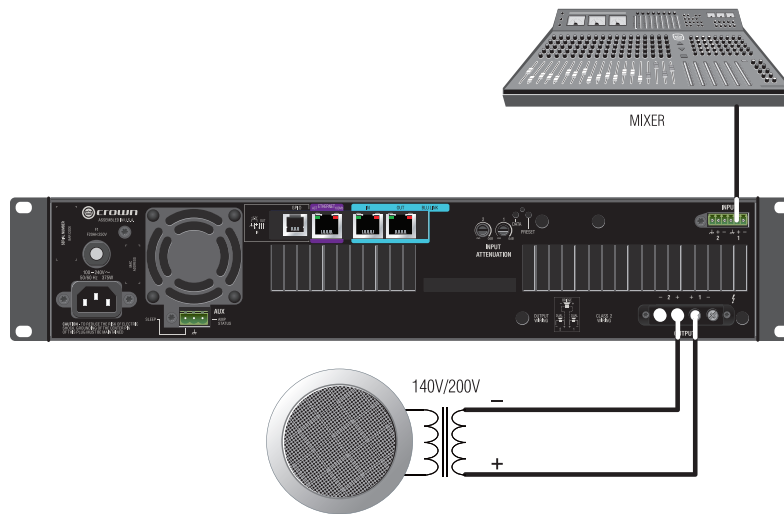
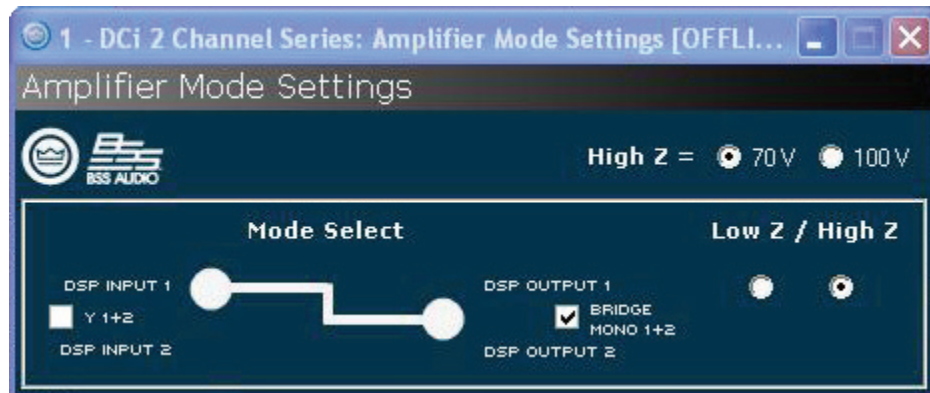

Figure 30 Amplifier Mode Settings-Bridge Mode Hi-Z



Always route the input and output wires in separate bundles.

General Purpose In/Out Control Port

CTS2 Network amplifiers come with a 2-in, 2-out General Purpose In/Out (GPIO) control port in the form of either a 6 position RJ-11 connector (CTS2-300N, CTS2-600N, CTS2-1250N) or a block connector (CTS2-2400N). The Control Port has multiple functions and uses which include preset selection and gain control, among others.

Hardware Specification

Inputs are capable of either binary or analog control of a State Variable (SV) within the amplifier. Outputs are binary only that represent an SV of the amplifier. Additionally, outputs can be controlled independently (on/off, polarity) via the software.

PIN 1: Output 1. 0 VDC to +3.3 VDC output. Output impedance = 1 K Ω pullup to +3.3V.

PIN 2: Output 2. 0 VDC to +3.3 VDC output. Output impedance = 1 K Ω pullup to +3.3 V.

PIN 3: Input 1. 0 VDC to +3.3 VDC input. Logic = TTL thresholds. Analog = full scale 0-3.3 V. Input impedance > 20 K Ω .

PIN 4: +3.3 VDC output. ILIMIT = 30 mA. Output impedance = 100 Ω to +3.3 V.

PIN 5: Input 2. 0 VDC to +3.3 VDC input. Logic = TTL thresholds. Analog = full scale 0-3.3 V. Input impedance > 20 K Ω .

PIN 6: GND.

Configuration of the Control Port Inputs

2 inputs: Can be variable (connect to potentiometer), binary (connect to switch), or multilevel connect to rotary switch and voltage steps.

- Audio Architect is used to assign up to 40 SV's to each input
- An input mode is selected

SET – Sets the assigned SV(s) to a specific value

VARY – Continuously varies the assigned SV(s) by a specified value, typically a volume pot application.

PRESET – Recalls the max preset in one state (high) and the min preset in the other state (low).

BUMP – Similar to vary but implemented with a button instead of a pot. A high level will bump the assigned SV(s) by a specific value.

AUTOBUMP – Similar to bump, but will continue to bump the assigned SV(s) value as long as the input state is changed.

Right click on a CTS2 Networked amplifier in the venue. Select “Configure Control Ports”. A new tab labeled “(amplifier name) – Control Ports” will open.

Software Parameters

High Limit – Available only on input, and only for parameters in “Analog Input” mode. This field determines the value that the selected assigned parameter will assume when the control port input is at the maximum end of its range.

Input – Selects between control port inputs, labeled 1 and 2.

Low Limit – Available only on input, and only for parameters in “Analog Input” mode. This field determines the value that the selected assigned parameter will assume when the control port input is at the minimum end of its range.

Mode – For the control port input, the Mode field determines how the assigned parameters will be controlled. For the control port output, the Mode field determines the conditions under which the output status will change.

Off Value – Available only on input, and only for parameters in “Direct Action” mode. Determines what the value of the selected assigned parameter will be when the control port input is logic “Low.”

On Value – Available only on input, and only for parameters in “Direct Action” mode. Determines what the value of the selected assigned parameter will be when the control port input is logic “High.”

Output – Selects between control port outputs, labeled 1 and 2.

Output Polarity – Enables selection between “Normal” and “Inverted.”

Parameter Assignment – List of parameters that are currently assigned to a given control port input.

Figure 31 Control Port Configuration Page

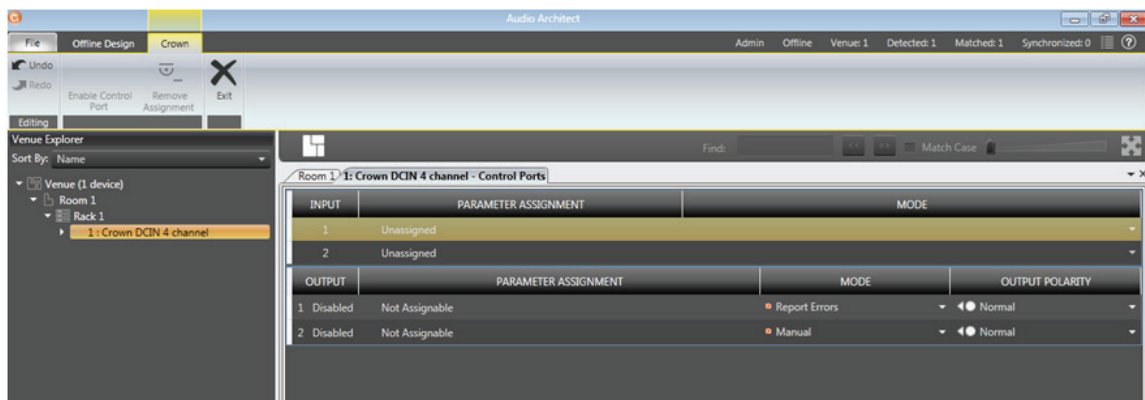

In the Venue Explorer, select and expand the device for a list of objects. Expand an object for a list of state variables (SV's) within the object. A state variable can be added to the control port input assignment by clicking and dragging with the mouse into the “Parameter Assignment” tab for either input 1 or 2.

Figure 32 Assigning the “Current Preset” parameter to Control Port Input 1

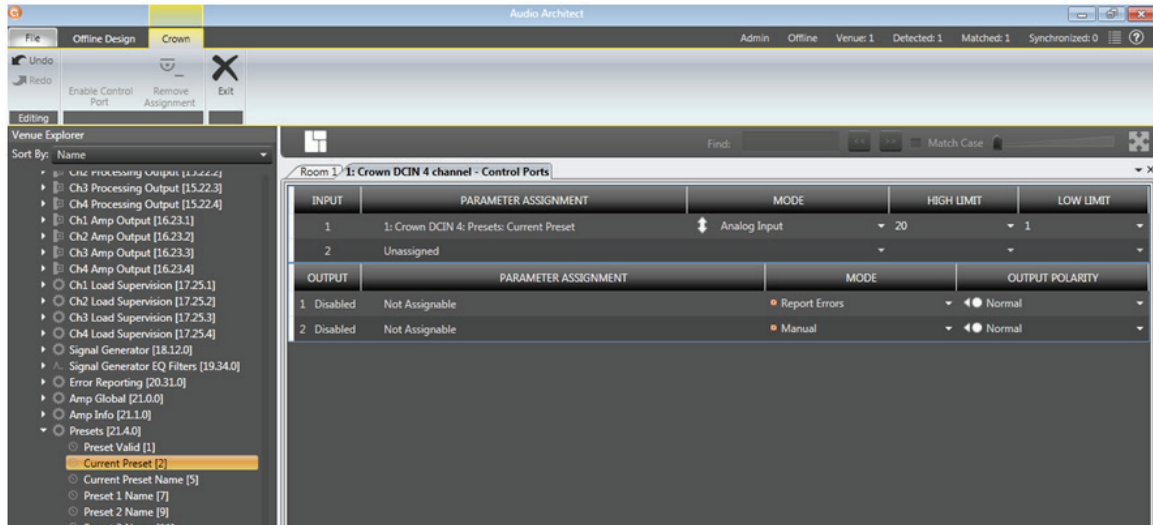

Once an SV has been added, its type will determine which MODE options become available. If a binary SV has been assigned, only the “Direct Action” mode is selectable, and the “ON VALUE” and “OFF VALUE” parameters can be toggled as desired. However, if a non-binary SV is added, the “Analog Input” Mode becomes available. In this mode, the ON and OFF VALUE fields are unused, and the “HIGH LIMIT” and “LOW LIMIT” fields appear and become accessible. The LIMIT fields allow control of an SV over a specified range.

Additional state variables can be added to a given control port input by selecting the SV and dragging on top of a previously assigned row of the desired input. However, once an SV has been assigned and the MODE has been set, any subsequent SV that is added must function in the same MODE. Up to 40 SV's can be assigned to a given input.

Figure 33 Output Faders and Output Mutes

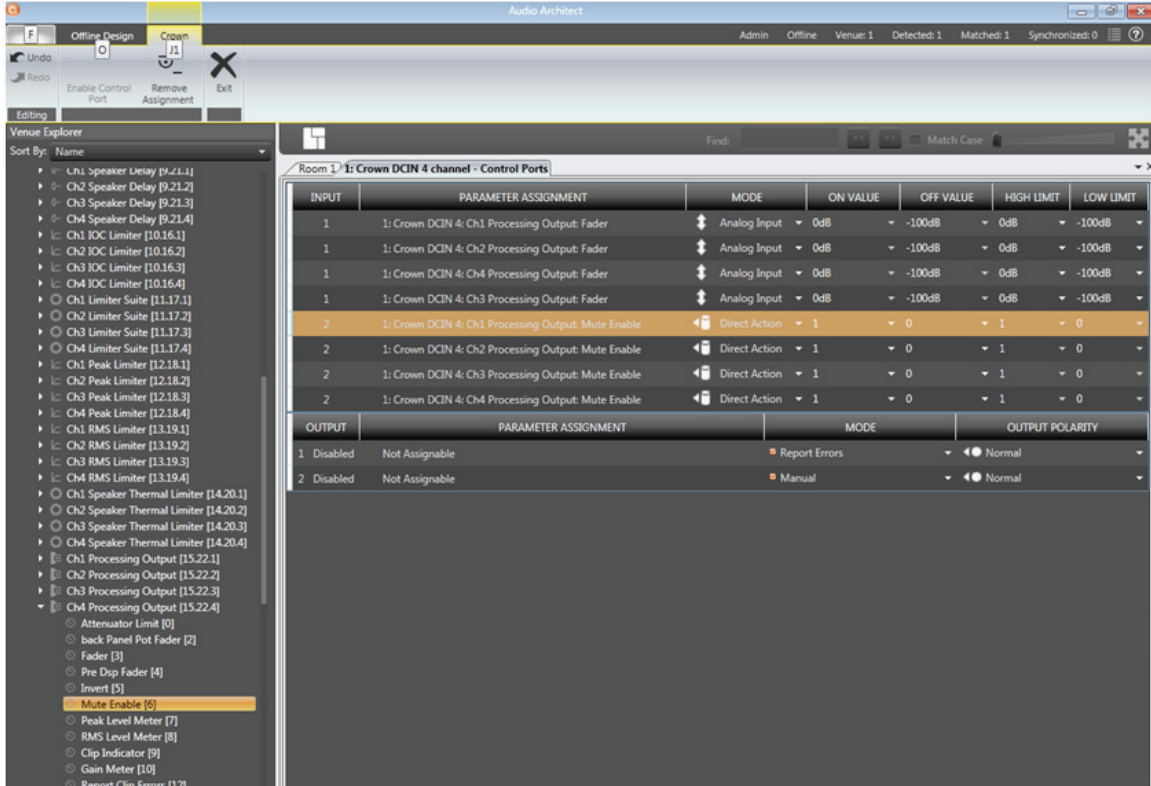

An assigned state variable can be removed by highlighting and selecting “Remove Assignment” in the upper left hand corner.

Configuration of the Control Port Outputs

2 outputs: Binary only.

- There is a polarity control on each output so that it may function as active-high or active-low
- Output Mode 1 - Manual: Controlled directly by the output enable button.
- Output Mode 2 - Report Errors: Active when any enabled error is reported. The indicator will stay on for up to 60 seconds after the error is cleared. Errors include:

Load Supervision

AC Line Voltage is out of range

Hardware Protection (faults)

Over temperature (any channel or power supply)

Amp output clipping

Processing output clipping (off by default)

Analog Input clipping (off by default)

- Output Mode 3 - Report online status: Active when HiQnet connection is lost. The length of time to wait for a time out is user adjustable, default = 60 seconds.

The Control Port output configuration options can be found directly below those for the input. No parameters can be assigned to the outputs. Instead, there are three modes available: Manual, Report Errors, and Report Online Status. Manual mode enables direct control over the selected output. In “Report Errors” mode, the output status will change if any errors are reported to the network, such as clip errors, temperature errors, line voltage errors, etc. Finally, in “Report Online Status” mode, the output status will change if no network communication is detected for at least 60 seconds. The control port output does not turn off right away when reporting errors or online status. There are several reasons for this. The online status does not change quickly, it can take up to 60 seconds to drop offline or to recover. In these modes, the output is intended to be used with devices such as a backup amp switcher or an electro-mechanical system. We want to prevent this output from toggling on/off quickly. It may take the output up to 90 seconds to recover (i.e. switch states) from an error or loss of connection.

Figure 34 Control Port Output Configuration

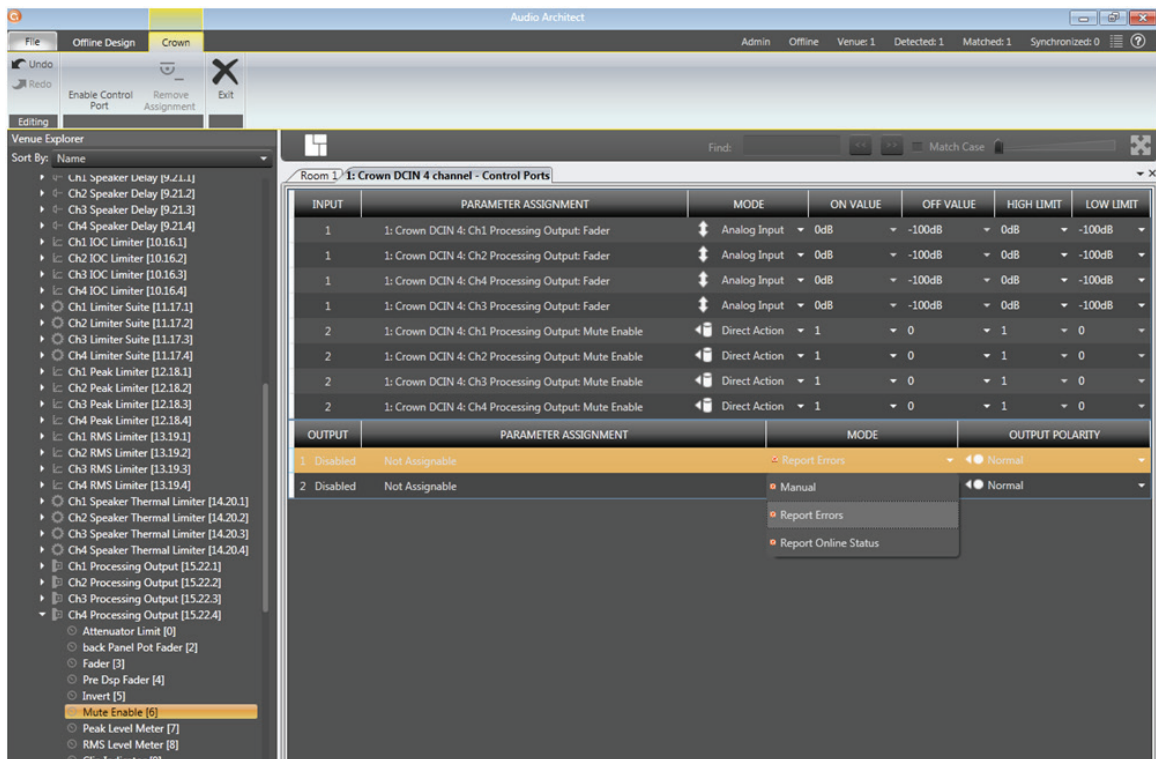

NOTE: In all modes, the polarity of the binary output can be toggled under the OUTPUT POLARITY tab, where “Normal” or “Inverted” can be selected.

Aux Port/Sleep/Amp Status (CTS2-300N, CTS2-600N, CTS2-1250N)

AUX Port

The AUX port can be used for basic monitoring of the amplifier and for remote standby. The port is a 3 pin block connector with pin-2 used as ground.

Sleep

The amplifier can be put to sleep by connecting pins 1 and 2 together on the AUX port. When applying this connection, the amplifier will shut down and remain in sleep until the connection between pins 1 and 2 is open. While the amplifier is in sleep, the front panel power button is disabled. When the connection between pins 1 and 2 is open, the amplifier will revert to its last configuration and begin to output audio within 20 seconds. Communication via the network will take as long as the network interface card boots. If the front power button is pressed while the amp is in sleep mode, the blue power indicator will blink twice.

Amp Status

AMP STATUS can be used for basic monitoring of the amplifier. Monitoring of the amplifier can determine if the amplifier is operating within optimal parameters or if the amplifier has been shut off or is in fault. Between pins 2 and 3, there will be either a +5 VDC potential or a 2 Hz square wave (heart beat). This option can be found in the AMP INFO button on the main amplifier page within Audio Architect.

CTS2-2400N

AUX Port

The AUX port can be used for basic monitoring of the amplifier and for remote standby. The AUX Port is combined with the GPIO block connector, with pin-6 used as a shared ground between the GPIO and the AUX Port.

Sleep

The amplifier can be put to sleep by connecting pins 8 and 6 together on the AUX port. When applying this connection, the amplifier will shut down and remain in sleep until the connection between pins 8 and 6 is open. While the amplifier is in sleep, the front panel power button is disabled. When the connection between pins 8 and 6 is open, the amplifier will revert to its last configuration and begin to output audio within 20 seconds. Communication via the network will take as long as the network interface card boots. If the front power button is pressed while the amp is in sleep mode, the blue power indicator will blink twice.

Amp Status

AMP STATUS can be used for basic monitoring of the amplifier. Monitoring of the amplifier can determine if the amplifier is operating within optimal parameters or if the amplifier has been shut off or is in fault. Between pins 7 and 6, there will be either a +5 VDC potential or a 2 Hz square wave (heart beat). This option can be found in the AMP INFO button on the main amplifier page within Audio Architect.

BLU link

BLU link

BLU link is an audio bus found on the CTS2 Network amplifier series. It carries 256 channels of audio at 48 kHz, and 128 channels at 96 kHz, both at 24 bit. When connected in a loop, it has redundancy, allowing any one BLU link cable to break while still maintaining audio.

BLU link Specification

- Based on Gigabit Ethernet technology
- 100 m over CAT5E cable between each point
- >100 m using fibre converters
- 256 Channels at 48 KHz
- 128 Channels at 96 KHz
- Bus-like architecture. Audio transmitted on a channel is available at all other devices on the network automatically.
- Wired in a loop for redundancy
- Recovers from a single cable break

Hardware Configuration

On the rear of the BLU link devices there are two BLU link ports. One is the BLU link In, and the other BLU link Out. Devices are connected together by wiring Out to In on all of the devices within your BLU link network, making sure that the loop is complete so that there are no empty BLU link ports. You should not connect the BLU link ports to anything other than BLU link ports. BLU link will not function if you try to connect the BLU link to an Ethernet switch for example.

Fault Tolerance

The network is capable of a degree of fault tolerance due to the fact that each device receives the same audio from 2 other devices. If a cable is broken the devices which are no longer connected will detect the cable break. One device will detect that its 'In' port is unconnected and the other will detect that its 'Out' port is undetected.

NOTE: when the cable is broken, the audio takes longer to reach its destination than before. This added delay is not compensated for in any way, but is a side-effect of the way the fault tolerance works.

Mastership

The BLU link network requires one device on the ring to act as master for the whole ring. The master will provide the clock for all the other devices on the ring. This means that the whole ring is synchronised to a single audio clock.

In certain cases, it is possible to utilize devices of more than one Ethernet transport type (AVB, CobraNet™, or Dante) connected within the same BLU link ring. In other words, if you're careful, you can design a Harman system which actually includes more than two transports. For example, it's possible for a Harman system to have CobraNet audio being converted to BLU link audio (BLU-800 and BLU-320 both have the ability to “bridge” CobraNet to/from BLU link), which is then converted to Dante audio (BLU-806 and BLU-326 both have the ability to “bridge” BLU link to/from Dante). It all depends on a given transport's ability to “slave” (AKA “re-clock”) to a clock being generated by a separate transport.

Can it be “slaved” to the clock of another transport?

AVB	No
BLU link	Yes
CobraNet	No
Dante	Yes

The previous chart has critical implications on system-design when combining two or more transports. Any system based on Soundweb London (including Architectural Media Systems) supports the following five multi-transport combinations:

- BLU link + AVB (AVB provides the clock)
- BLU link + CobraNet (CobraNet provides the clock)
- BLU link + Dante (either BLU link or Dante provides the clock)
- BLU link + Dante + AVB (AVB provides the clock)

Any multi-transport combination NOT specifically listed above is not allowed in Soundweb London systems (without being forced to use analog interconnects between transports). For example, BLU link + AVB + CobraNet is NOT allowed, because the AVB and CobraNet networks would each be synced to different clocks—their own.

Mastership is negotiated between all the devices on the ring, and change to the ring will trigger the negotiation to be started. There are various rules for determining which device on the ring becomes clock master:

- If there is only one device connected to CobraNet/AVB then that is master.
- If there are multiple devices connected to CobraNet/AVB, then they compare master priorities.
- If there are multiple devices on CobraNet/AVB with the same highest priority, then they use MAC address to decide which is master.
- If there are no devices connected to CobraNet/AVB, then they first compare master priorities. Next, if the priorities are the same, they compare MAC addresses.

BLU link LED indicators

These are found on the BLU link ports on the back panel of the device and indicate the following:

- Green LEDs

The green LED will indicate a link on that particular port.

- Orange LEDs

Both on: The box is the master. (No green LEDs will be on if no cables are connected).

Only one on: The box is locked to the data coming in on that particular port.

Both off: Boxes not locked.

BLU link Routing

The CTS2 Network Amplifiers series can use both analog and/or BLU link inputs.

The CTS2 Network Amplifiers series can use both analog or BLU link inputs. To configure the input section of the amplifier, Input Icon > Source Routing > Input Configuration. This page allows you to make changes to the levels of the various sources. This feature allows you to not only adjust for different signal levels from the source (i.e. analog is quieter than BLU link) as well as being able to be used for an additional location of gain if needed. The meters on this page allow you to see both Peak and RMS levels. You are also able to set the maximum input level for the amplifier which will affect both channels. Rx Status lights below each BLU link input channel provide confirmation of slot assignment.

NOTE: Gain Mode for the analog inputs can be used to maximize the Signal to Noise Ratio.

Figure 35 Input Configuration

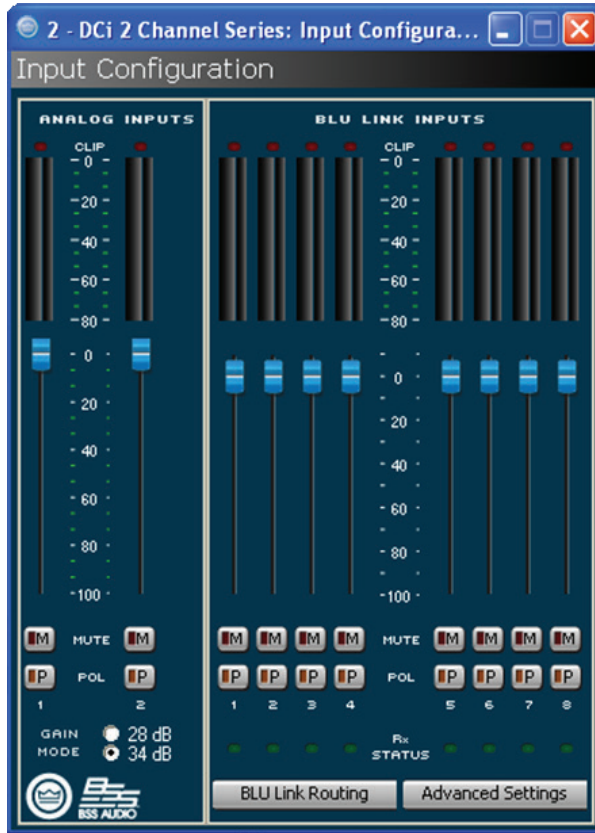

Figure 36 BLU link Input Channel Assignment

1: DCI 8300N BLU Link Input Channel Assignment

BLU Link Bus : BLU Link Bus 1						DCI 8300N BLU Link Input	
Slot	Names	Transmitting Device	Transmitting Objects	Receiving Devices	Receiving Objects	Input Channels	
1	Left	2: BLU-806	BL Output	1: DCI 8300N	Network Input A [1]	1: Network Input A [1]	
2	Center	2: BLU-806	BL Output	1: DCI 8300N	Network Input B [2]	1: Network Input B [2]	
3	Right	2: BLU-806	BL Output	1: DCI 8300N	Network Input C [3]	1: Network Input C [3]	
4	SR	2: BLU-806	BL Output	1: DCI 8300N	Network Input D [4]	1: Network Input D [4]	
5	SBR	2: BLU-806	BL Output	1: DCI 8300N	Network Input E [5]	1: Network Input E [5]	
6	SBL	2: BLU-806	BL Output	1: DCI 8300N	Network Input F [6]	1: Network Input F [6]	
7	SL	2: BLU-806	BL Output	1: DCI 8300N	Network Input G [7]	1: Network Input G [7]	
8	Sub	2: BLU-806	BL Output	1: DCI 8300N	Network Input H [8]	1: Network Input H [8]	
9							
10							
11							
12							
13							
14							
15							
16							
17							
18							
19							
20							
21							
22							
23							
24							
25							
26							
27							
28							

Show BIB/BOB DIP Switch Settings
 Valid BLU link channel
 Warning in assigned BLU link channel
 Error in assigned BLU link channel

OK Cancel Clear

BLU link Routing

Double-clicking on the BLU link Routing button opens the BLU link channel assignment dialog. The CTS2 Networked amplifiers have 8 ‘slots’ (labeled A through H) available for receiving a BLU link audio stream, which can then be sent to any one of the channels in the amplifier via the Source Routing panel. Click and drag a stream from the list of BLU link channels on the left, and drop it into one of the 8 channel slots (A-H) available on the right side of the dialog labeled Output Channels. Then go to Source Routing to assign that audio stream to an amplifier channel by selecting BLU link Input A through H from the drop-down menus presented. If you know the BLU link channel number you want to use, it can be assigned to a slot (A-H) on the Input Source Routing window by typing the BLU link channel number into the field next to the desired input slot letter. Press enter after entering the number for changes to take effect.

Output Configuration

Double-clicking on the BLU link Routing button opens the BLU link channel assignment dialog. The CTS2 Networked amplifiers have 8 ‘slots’ available for receiving a BLU link audio stream, which can then be sent to any one of the channels in the amplifier via the Source Routing panel. Click and drag a stream from the list of slots on the left, and drop it into one of the 8 channel slots available on the right side of the dialog labeled Output Channels. Then go to Source Routing to assign that audio stream to an amplifier channel by selecting BLU link Input 1 through 8 from the drop-down menus presented.

Figure 37 BLU link Output Configuration

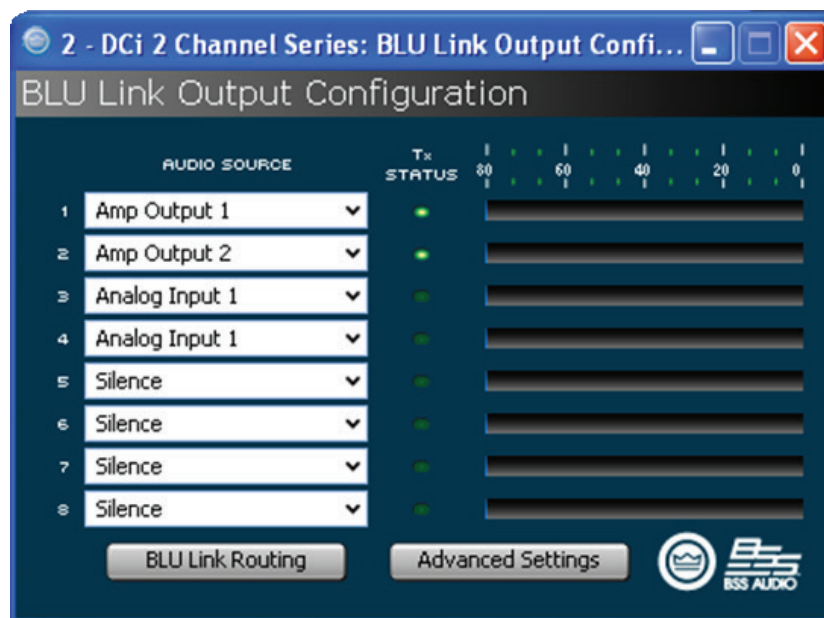

The analog inputs for the CTS2 Network amplifier provide additional flexibility when for the BLU link digital audio bus. From the BLU link Output Configuration window (Input Icon >Source Routing > BLU link Output Configuration), it is possible to use the CTS2 Networked amplifier to be a BLU link On-Ramp in two different ways:

Send unprocessed audio from the analog inputs of the amplifier to 1 of the 8 available BLU link outputs.

NOTE: The audio from the analog inputs passes through the amplifier input gain stage (affected by selecting 28 dB or 34 dB of gain), and then through the input trim and polarity switches in the Source Routing - Input Configuration panel, before being sent to the BLU link bus.

Send post-processing audio from a CTS2 Networked amp channel to 1 of the 8 available BLU link outputs

NOTE: The post-processing audio is bussed from a point at the end of the entire channel processing chain in the CTS2 Networked amplifier. This is effectively analogous to taking the audio from the physical output of the amplifier feeding a loudspeaker, and routing it onto the BLU link network.

After selecting an Audio Source in the dialog box shown above, double-click on the BLU link Routing button. It is absolutely necessary to take this additional step, which allows the 8 BLU link output slots inside CTS2 Networked amplifier to then be routed onto one of the slots available on the larger BLU link audio ring.

NOTE: BLU link Outputs (on-ramp from CTS2 TO BLU link) are disabled when the BLU link network is operating at 96 kHz sampling rate.

When attached to a BLU link network running at 96 kHz, CTS2 will not be usable as an on-ramp. The amplifier will be able to receive a full compliment of up to 8 streams to send to the input router, but it will not be able to send any analog or post-processing audio signals back onto the BLU link network.

Latency using BLU link in CTS2 Networked Amplifier

Table 8 Total Latency

Path	Total Latency (for selected path)
Analog Input to Amplifier Output	1.67 ms
Analog Input to BLU link Output	1.0 ms
48 khz BLU link to Amplifier Output	2.47 ms
96 khz BLU link to Amplifier Output	2.27 ms

See “BLU link” on page 57 for more information about operation at different sample rates, mastership priority, and for more help on BLU link audio.

Advanced Operation

Introduction

Your CTS2 amplifier has a wide variety of onboard Digital Signal Processing (DSP). HiQnet Audio Architect software lets you adjust the DSP settings, such as filter slope, compression ratio, EQ frequency bands, and so on.

Amplifier Presets and Speaker Tunings

Preset 1 is the factory default preset and cannot be overwritten. It sets up the amplifier for pass-thru operation with no DSP features enabled. The CTS2 amplifier works with two types of presets:

User presets – Using Audio Architect, you can create your own custom DSP presets, label them, and send them to the Install amplifier. The amp stores those presets in firmware.

Downloadable Presets – Available for download from a variety of manufacturers, these presets are configured for optimal performance and can be sent to the amplifier via Audio Architect.

User Presets

User presets are DSP presets that are configured manually. The following three steps outlines setting up User Presets.

1. Adjust the DSP settings as desired in the Audio Architect software.
2. Save this group of settings as preset, you will be prompted to name it.
3. Download the preset to the CTS2 amplifier. See the software Help file for details. As soon as you save the setting as a preset, it is sent to the amplifier.

Speaker Tunings

An improved speaker tuning approach has been developed for the CTS2 Network Series. The system is software library based rather than device preset based. The new approach offers significant benefits:

- Unlimited number of tunings organized into an unlimited number of libraries.
- Simple and fast drop-down tuning recall/store/delete within device GUI.
- Channel/band specific tunings – no more managing tunings across channels or amp chassis. Also yields logical one-to-one correlation of amp output to transducer/band.
- Faster tuning load/store times – much easier to compare and run A/B tests on multiple tunings without audio dropouts.
- Library based – allows logical groupings and archiving of similar tunings (for example, Screen Array Series or VTX Series, etc.).

- Tunings can be held within but are de-coupled from device presets. Eliminates concern of accidentally deleting or changing other device parameters – speaker tunings only contain the parameters required for speaker tunings! Now presets can be used for complete device configurations – as intended.
- Simpler and faster third-party and user tunings and libraries development – more people will be willing to develop custom or 3rd party tunings.
- Single panel access to all required tuning parameters – easier/faster to create/modify tunings.

Speaker Tuning Panel

A new “speaker tuning” icon is implemented on the main device panel for each channel of CTS2 amplifiers. Double-clicking the speaker tuning icon will open the basic Speaker Tuning Panel (STP).

Figure 38 Basic Speaker Tuning Panel



Basic STP functions are as follows:

Recall

Loads the selected tuning from the working library (drop-down list) into the respective channel.

Store

Stores the STP settings from the respective channel into the working library with specified user name. The stored tuning is then available in the drop-down list for any other channel or amp.

Delete

Deletes the selected tuning from the working library.

Speaker Manufacturer

This parameter displays a text description of the respective speaker manufacturer (i.e. JBL, Custom, etc.). The data for this parameter is stored within the tuning and also within the device settings.

Speaker Model

This parameter displays a text description of the respective speaker model (i.e. 3722, Three-Way, etc.). The data for this parameter is stored within the tuning and also within the device settings.

Band

This parameter displays a text description of the respective tuning band (i.e. LF, MF, HF). The data for this parameter is stored within the tuning and also within the device settings.

Tool Tips

The Mfr, Model and Band text fields are displayed in the tool tip box when the mouse is hovered over the respective channel Speaker Tuning Icon.

Advanced STP functions are available to create/modify speaker tunings. Holding CTRL-ALT-SHFT while double-clicking the speaker tuning icon opens the advanced panel. (See Figure 39.)

Figure 39 Basic Speaker Tuning Panel

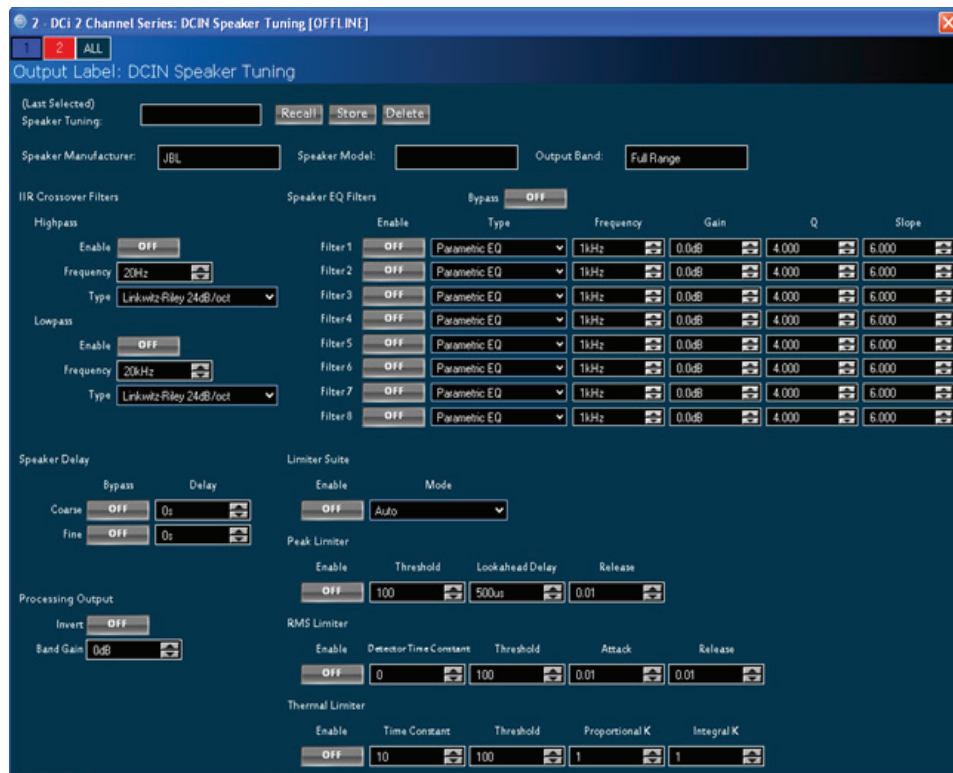

The advanced panel includes every parameter implemented in a speaker tuning :

1. All parameters from basic panel (Recall, Store, Load, Delete, Mfr Name, Model, Band)
2. Crossover Filters (HP lower band-edge, LP upper band-edge, 18 types up to 48 dB/oct)
3. EQ Filters (8 second order filter sections, 11 types, full parametric control)
4. LevelMax Limiter Suite (Peak, RMS, Thermal Limiters, Auto/Manual modes)
5. Delay (Fine adjustable from 0S to 0.1S, Coarse adjustable from 0S to 2S)
6. Band Gain (adjustable from -100 dB to +20 dB in 0.5 dB steps)
7. Polarity/Invert

Speaker Tuning Libraries

The new system uses software based Speaker Tuning Libraries. Audio Architect manages these libraries within the device DLL. A library can contain any number of tunings. Audio Architect can manage any number of libraries. The library system implemented includes:

Working Library

The working library is opened and active when opening any Speaker Tuning Panel. The working library is automatically updated with the latest stored tunings/settings when exiting the open STP. Audio Architect is installed pre-configured for CTS2 amplifiers with a working library previously loaded with JBL Screen Array tunings from the JBL Master Screen Array Library. NOTE: Multiple STP's can be opened but only the last parameters on the last panel closed are saved to the working library.

JBL Master Screen Array Library

This library is included with Audio Architect at install. The tunings in this library were developed and validated against previous same tunings for DSI amplifiers. It is read-only to prevent over-write. At any time, a user can load this library to access reference JBL tunings for these devices.

User Libraries

At any time, the user may save the current working library to a custom user library file.

Loading a Library

Click on the File/Open > Speaker Tuning dialog on the device main panel to open and load an existing library file into the working library. This action replaces the current working library. Any changes not saved to the existing working library will be lost.

Saving a Library

Click on the File/Save > Speaker Tuning dialog on device main panel to save the current working library to any filename. **NOTE:** JBL files are write-protected/read-only and cannot be over-written.

Library File Locations

The file location and naming conventions for all speaker tuning libraries is:

- Windows 7 and Windows 8.1 path C:\ProgramData\Harman Professional\Audio Architect\
- Windows XP path C:\Documents and Settings\All Users\Application Data\Harman Professional\Audio Architect\

Library Filename Conventions

The general file names are as follows:

- Working Library: Crown Library.DCi Series.SpeakerTuning
- JBL Screen Array Library: JBL Master Screen Array Library.DCi Series.SpeakerTuning
- User Libraries: Any_user_file_name.DCi Series.SpeakerTuning

Software-Controllable Onboard DSP

The CTS2 Network amplifier has Digital Signal Processing built into the amplifier.

When you use a CTS2 Network amp, the loudspeaker processors, crossovers, limiters and delays are in the onboard DSP – so discrete rack mount devices are not needed. This drastically cuts setup time, commissioning, rack space and costs. The CTS2 Network DSP can be monitored and controlled with a computer running Audio Architect software, and connected to the amplifier Network Connector by a Category 5 Network cable.

Some applications for this DSP are as follows:

- Configure signal flow
- Optimize system gain structure
- Configure speaker configurations (set the drive levels, frequency bands, delays and limiting for your particular speakers)
- Configure EQ, filtering, and much more..

See the Audio Architect Help files for more detailed information.

Figure 40 Amplifier DSP Functions



On the left of this screen is the Input and Output Signal Level Monitor (explained later). On the right side are rows of DSP selection buttons for each channel. When you double click on a button, a control panel opens for that button's function.

Also on the right are buttons that open control panels for these functions:

- Amplifier mode
- Signal generator (pink noise and sine wave)
- Amplifier information
- Recall and store presets
- Preset manager
- Apply to others (apply this amplifier's DSP settings to other devices)

These functions are defined on the next several pages.

Input Level, Faders, Mute, Link, I/O Level Meters, and Indicators Figure 41 Amplifier DSP Functions: Levels, Faders, Mute

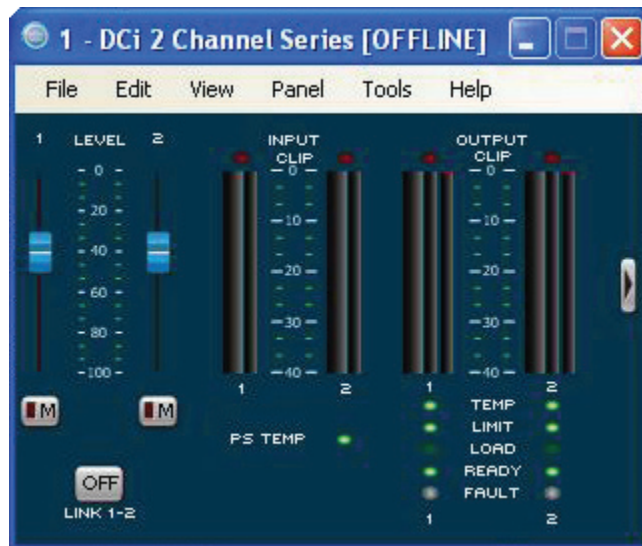

This panel is on the left side of the CTS2 Network main control panel shown above. Channels 1, and 2 Level Controls set the input signal level of each channel. Each channel can be muted, and both faders can be linked with the Link button.

Input Signal Level Meter (green)

The measurement range is from 0 dBFS to -40 dBFS with 0.5 dB resolution. Each audio channel has the following monitors:

- Switched Audio Input: This meter shows only the switched (selected) audio input after the Input Audio Router.
- Clip Indicator
- Peak + RMS levels

Output Signal Level Meter (blue)

The measurement range is from 0 dB to -40 dB with 0.5 dB resolution. The monitors are scaled so that 0 dB is referenced to the full rated output voltage of the amplifier. The wider left meter is rms and the right meter is peak for each channel. An output clip indicator is provided.

Indicators

- Temp: Lights if the temperature of the amplifier is too high and the amplifier is near shutdown.

Green: Thermal headroom used up is less than 59%.

Yellow: Thermal headroom used up is 60-80%.

Red: Thermal headroom used up is more than 81%.

- Limit: Lights when the amplifier signal is being limited.
- Load: Lights when the load impedance is out of range.
- Ready: Lights when the amplifier is on and ready to supply power.
- Fault: Lights when the amplifier is in a fault mode service may be required.

Input Signal Router

Each channel of the CTS2 signal processing has an Input Signal Router that lets you choose the audio signal that will be used by the channel.

- Analog Audio: This selection set up the input router for analog sources. Each output channel will select its corresponding analog input. Choices for the Analog Audio input are Channel 1, Channel 2, or a sum of Channels 1 and 2. Selecting Analog only will automatically change the MEDIUM input source to none.
- BLU link Digital Audio: This is the audio input from the BLU link connector on the back panel of the amp. Each amplifier has 8 BLU link input channels, plus 4 pairs of BLU link summed channels. This does not represent the BLU link channels 1-256, but rather the BLU link input channels that have been assigned to amplifier input slots A-H.
- Digital with Analog Backup: The input takes the digital signal as its source when the digital signal or just the digital clock is present. If the digital lock is lost, the input switches to the selected Analog Source. Once that digital lock is found again, the input switches back to the selected digital source. This works even when the digital signal has no audio but is sending a clock signal.
- Analog Overrides: BLU link input takes the digital signal as its source. If the analog signal level is greater than an Analog Signal Threshold that the user defines, the input switches to the analog signal. As long as the analog signal level exceeds the threshold, or as long as its level falls below threshold for a user-defined hold time, the input remains the analog signal

The control operation will vary based on the mode that is selected.

Figure 42 Input Signal Router

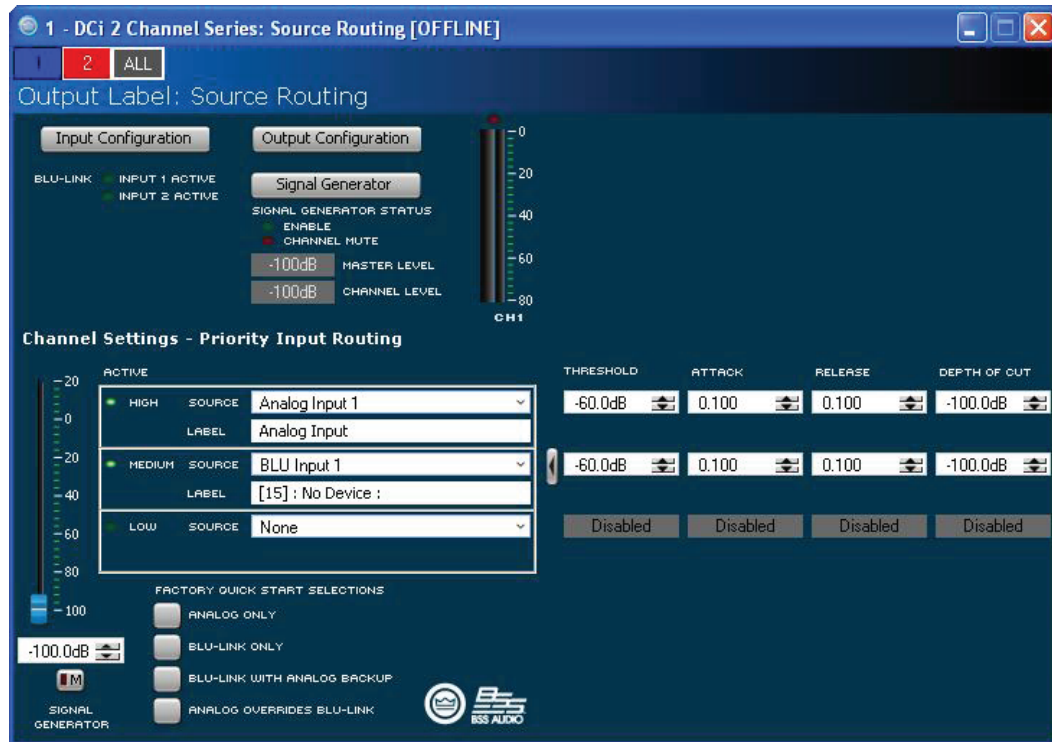

Source Routing/Configuration
Figure 43 Source Routing/Configuration

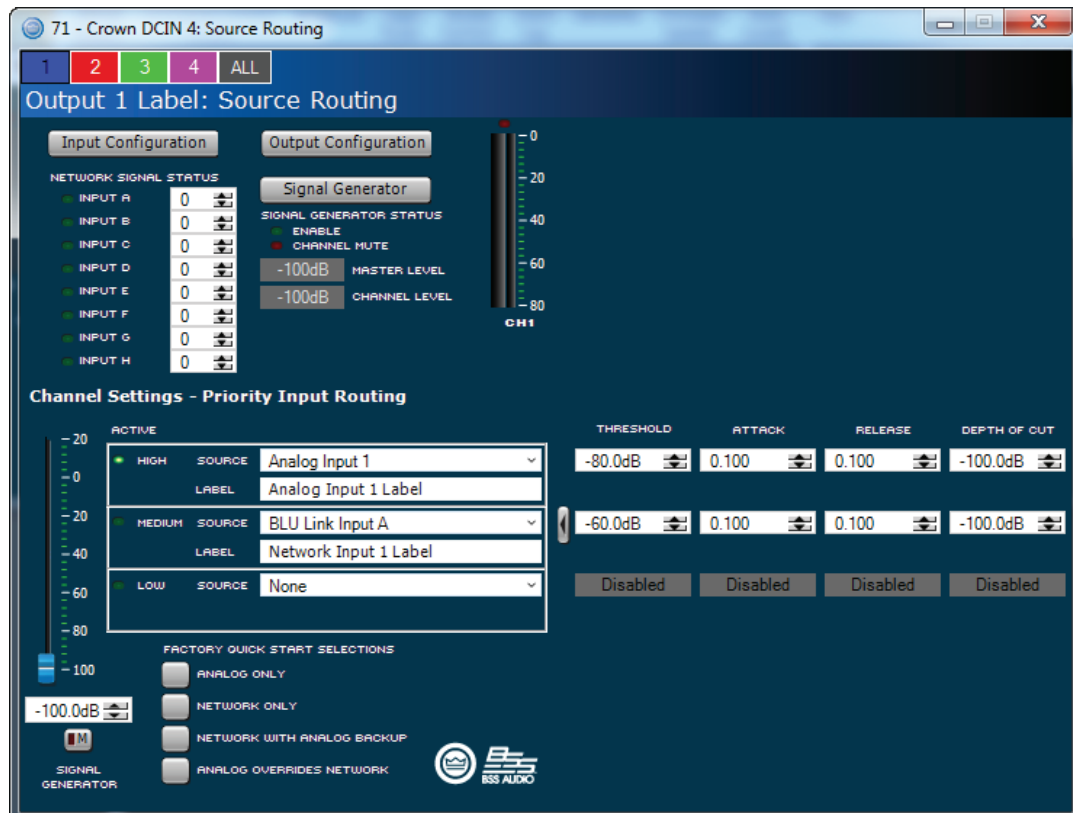

Quick Start Selection button at the bottom of the page. Manual configuration of Threshold, Attack, Release, and Depth of Cut can be adjusted in this page. These items are defined as follows:

- Threshold – Sets the level in dB below which the secondary input will be engaged.
- Attack – Defined as the time it takes for the secondary source to engage. This can range from 0.1 seconds to 1.0 seconds
- Release – Defined as the time it takes for the primary input to re-engage once the threshold level is exceeded.
- Depth of Cut – Defined as the level in dB of the primary source is held at if the release time is not exceeded.
- Analog Only: This is the audio input from the audio connector on the back panel of the amp. Choices for the Analog Audio input are Channel 1, Channel 2, or a sum of Channels 1 and 2.

Input Delay and Driver/Output Delay

Input delay includes up to 2 seconds of delay. Output delay is typically used for driver alignment. Up to 0.1 seconds of output delay is provided. (See Figure 44.)

Figure 44 Input Delay

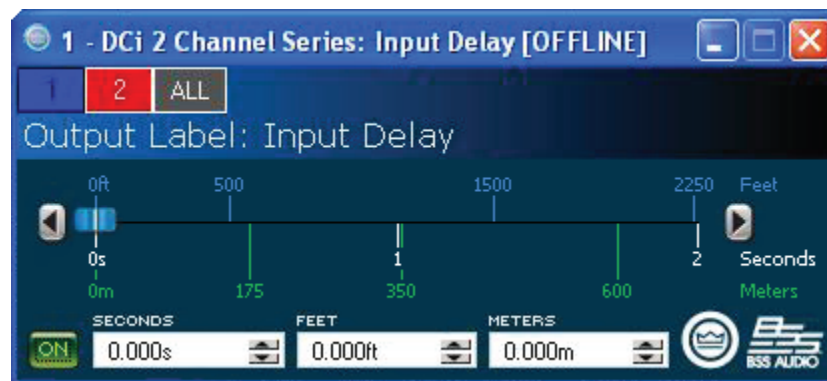

Input/Output Equalization

These screens let you adjust channel equalization for up to 8 frequencies. You can select filter type, frequency, gain, and bandwidth in octaves or Q as set by the user preferences in Audio Architect. Changes to the equalizer's frequency response can be done by typing in parameters or by click-dragging the response curve. (See Figure 45.)

Figure 45 Input EQ



Crossover Filters

The Crossover section lets you use infinite impulse response (IIR) Crossover filter. Each audio channel has three separate places where filters can be placed in the system: input EQ, Crossover, and Output EQ. Up to 16 EQ filters per channel are available, plus crossover filters. Each filter has up to +/-24dB of gain. The following filters are available:

- Lowpass & Highpass:
 - Bessel 12dB/oct, 18dB/oct, 24dB/oct, 30dB/oct, 36dB/oct, 42dB/oct, 48dB/oct –
 - Butterworth 12dB/oct, 18dB/oct, 24dB/oct, 30dB/oct, 36dB/oct, 42dB/oct, 48dB/oct
 - Linkwitz-Riley 24 dB/oct, 36 dB/oct, 48 dB/oct
- Lowshelf: Low-frequency shelving EQ
- Highshelf: High-frequency shelving EQ
- Lowpass EQ: Variable bandwidth, can be expressed as Q (0.100 to 35) or Octaves (0.041 to 6.672)
- Highpass EQ: Variable Q from 0.1 to 25
- Parametric EQ: Variable Q from 0.1 to 35

Figure 46 Crossover Filters

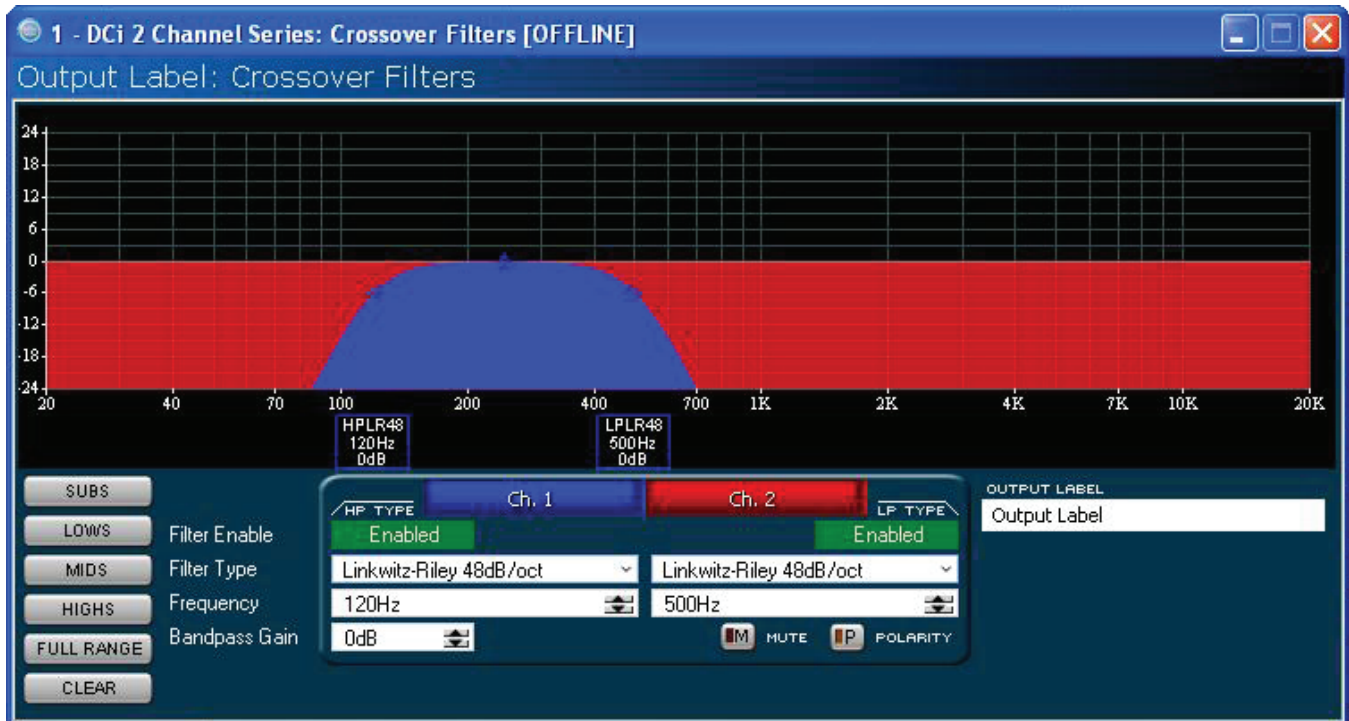

LevelMax™ Suite

This is a suite consisting of a peak voltage limiter, RMS power limiter, clip limiter and transducer thermal limiter. First you will set the mode to automatic or advanced. (See Figure 47.)

- Automatic mode: The software determines the best settings based on the signal characteristics. You can modify only the RMS threshold, Speaker Thermal threshold and time constant. Everything else is set automatically.
- Advanced mode: You can modify the RMS threshold, Speaker Thermal threshold, time constant, Peak threshold and Peak/RMS release. Peak Voltage Limiter This limits the peak voltage output of the amplifier.
- On: Enables or disables this function. You'll set the parameters below:
- Threshold: Sets the level, in absolute voltage, which the limiter will allow from the amplifier. The range is from 1 Vpk to 255 Vpk.
- Attack Time: Sets the attack time of the limiter. The attack time is defined as the time it takes the limiter to attenuate the output signal by 20 dB. The range is from .1 millisecond to 100 milliseconds. The Instant setting attack time is instant (0 millisecond).
- Release Time: Sets the release time of the compressor. The release time is defined as the time it takes the limiter to increase the output signal by 20 dB. The range is the same range as attack time above.

Figure 47 Output Limiters

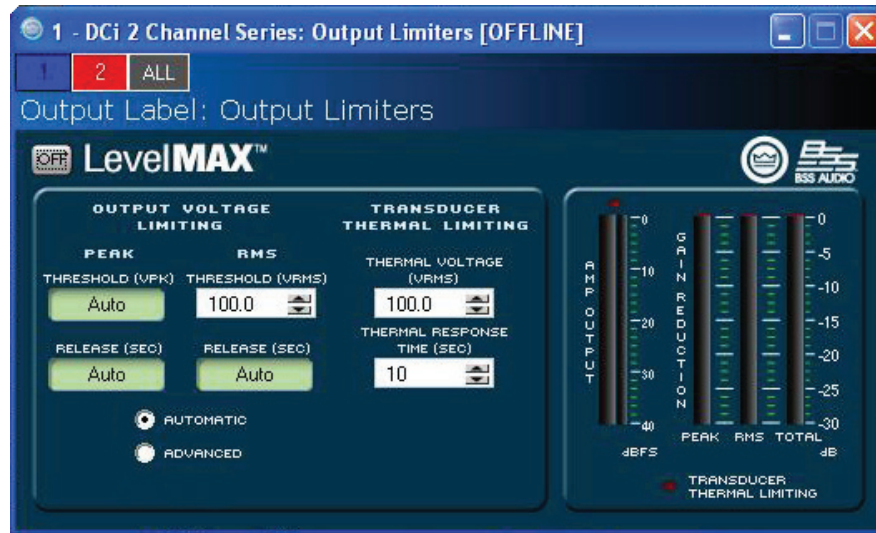

Transducer Thermal Limiter

This limits the long-term output power of the amplifier to what the loudspeaker load can handle without overheating and going into thermal compression. You can set the voltage level at which the thermal limiter engages, the thermal response time and thermal voltage. Your loudspeaker manufacturer might be able to provide this information.

Meters show the amplifier output level in dBFS; and peak, RMS, and total gain reduction.

Signal Path

Figure 48 CTS2 Signal Path

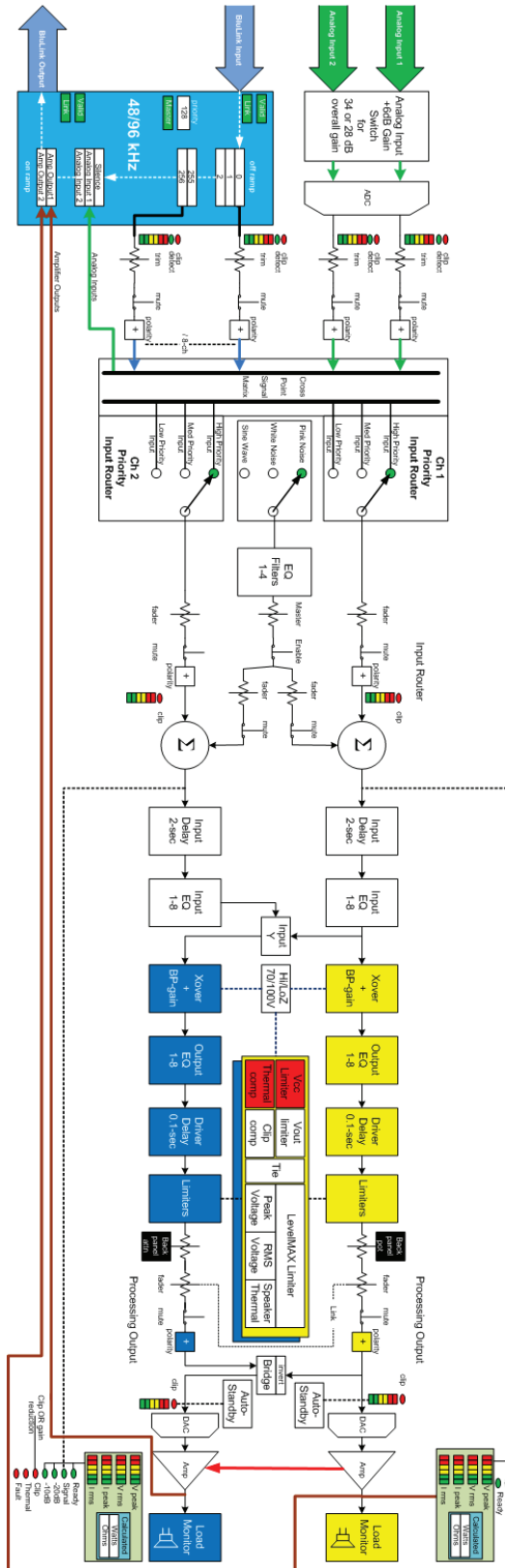

CTS2 Signal Path

Troubleshooting

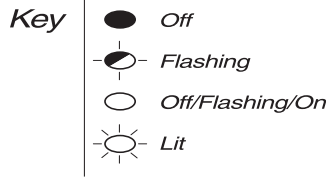

“Off/Flashing/On” above means that the LED can be off, or flashing, or on.

CONDITION: Power indicator is off. Mains indicator is on.

POSSIBLE REASON

- The amplifier's Power switch is off.

CONDITION: Power indicator is off. Mains indicator is off.

POSSIBLE REASON

- The power supply fuse has tripped.
- The amplifier has lost AC Power.
- The amplifier is not plugged in to the power receptacle.

CONDITION: Power indicator is flashing.

POSSIBLE REASON:

- The AC line voltage has dropped below 10% or has risen above 10% of the nominal line voltage of the power supply.
- When the Amp is in Sleep Mode as set by the AUX Port, the amplifier will not power up until the ground closure on the AUX Port is released. When the power button is pushed in this condition, the Power Indicator will flash for 2 – 3 seconds.

CONDITION: Thermal indicator is on.

POSSIBLE REASON:

- The amplifier is becoming too hot for safe operation. Allow amplifier to cool. Check for loads less than 2 ohms, and for excessive input levels. Check for proper ventilation and proper mode-switch setting.

CONDITION: Fault indicator is flashing.

POSSIBLE REASON:

- There are a number of conditions that result in the Fault indicator flashing: temperature above 98C, DC/LF protection is engaged, HF detect, output short circuit detected. These conditions should all be checked and attempted to be resolved before the amp is shipped back for service.

CONDITION: Distorted sound.

POSSIBLE REASON:

- Load is wired incorrectly or Stereo/Bridge mode switch is set incorrectly. Check both.
- Input is overloaded by a signal level that is too high. Turn down your amplifier level controls, or turn down the input signal, until the clip light goes out.

Note: If the signal sounds distorted even though the Clip LED is off, the input signal may be distorted before it reaches the amplifier input. Check gain staging and output levels of the mixer or preamp.

CONDITION: No sound, even though the amp has power. Power LED is on without flashing and the amp is receiving an input signal. Signal indicator is flashing.

POSSIBLE REASON:

- Speakers not connected.
- Open circuit due to speaker failure.
- Based on the front panel LEDs, determine which channel has a short. Remove the associated input connector to ensure that no voltage will be present on the output. Remove the shorted load (and possibly attached cables) and have it checked by a qualified technician. If the shorted condition remains after the load is removed, the unit should be sent into a qualified service center.
- Ready LED is off. Channel has been set to Sleep mode via the Aux port or Power Save mode.

Troubleshooting

Fault	●	
Thermal	●	
Clip	●	
-10	●	
-20	●	
Signal	●	
Ready	☀	
	○	
	○	

Power ☀
Data ○

Bridge

CONDITION: No input signal. Signal indicator is not flashing even though audio is applied, and the channel is ready..

POSSIBLE REASON:
Input signal level is very low.

	☀	
	●	
Power	☀	
Data	●	
Bridge	☀	

Power ☀
Data ●

Bridge

CONDITION: Bridge LED is lit.

POSSIBLE REASON:

- Amplifier is in bridge-mono mode.

Specifications

Table 9 Dual-Mode - All Channels Driven

CTS2	Channels	2 Ohms	4 Ohms	8 Ohms	16 Ohms	70 Ohms	100 Vrms
CTS2-300	2	150 W	300 W	300 W	150 W	300 W	300 W
CTS2-600	2	300 W	600 W	600 W	300 W	600 W	600 W
CTS2-1250	2	1250 W	1250 W	1250 W	625 W	1250 W	1250 W
CTS2-300N	2	150 W	300 W	300 W	150 W	300 W	300 W
CTS2-600N	2	300 W	600 W	600 W	300 W	600 W	600 W
CTS2-1250N	2	1250 W	1250 W	1250 W	625 W	1250 W	1250 W
CTS2-2400N	2	2100 W	2400 W	1900 W	950 W	2100 W	2300 W

Table 10 Bridge Mono Mode - All Channels Driven

CTS2	4 Ohms	8 Ohms	16 Ohms	140 Ohms	200 Ohms
CTS2-300	300 W	600 W	600 W	600 W	600 W
CTS2-600	600 W	1200 W	1200 W	1200 W	1200 W
CTS2-1250	2500 W	2500 W	2500 W	2500 W	2500 W
CTS2-300N	300 W	600 W	600 W	600 W	600 W
CTS2-600N	600 W	1200 W	1200 W	1200 W	1200 W
CTS2-1250N	2500 W	2500 W	2500 W	2500 W	2500 W
CTS2-2400N	4200 W	4800 W	3800 W	4200 W	4600 W

Table 11 Input Sensitivity

CTS2 Model	8 Ohms	70 V	100 V
CTS2-300	1.0 V	1.4 V	2.0 V
CTS2-600	1.4 V	1.4 V	2.0 V
CTS2-1250	2.0 V	1.4 V	2.0 V
CTS2-300N	1.0 Vrms	1.4 Vrms	2.0 Vrms
CTS2-600N	1.4 Vrms	1.4 Vrms	2.0 Vrms
CTS2-1250N	2.0 Vrms	1.4 Vrms	2.0 Vrms
CTS2-2400N	2.5 Vrms	1.4 Vrms	2.0 Vrms

Table 12 Dimensions

CTS2 Model	Width	Height	Depth
CTS2-300	19 in. (48.3 cm)	3.5 in. (8.9 cm)	14.25 in. (36.2 cm)
CTS2-600	19 in. (48.3 cm)	3.5 in. (8.9 cm)	14.25 in. (36.2 cm)
CTS2-1250	19 in. (48.3 cm)	3.5 in. (8.9 cm)	14.25 in. (36.2 cm)
CTS2-300N	19 in. (48.3 cm)	3.5 in. (8.9 cm)	14.25 in. (36.2 cm)
CTS2-600N	19 in. (48.3 cm)	3.5 in. (8.9 cm)	14.25 in. (36.2 cm)
CTS2-1250N	19 in. (48.3 cm)	3.5 in. (8.9 cm)	14.25 in. (36.2 cm)
CTS2-2400N	19 in. (48.3 cm)	3.5 in. (8.9 cm)	19 in. (48.3 cm)

Specifications

Table 13 Performance Specifications for Analog

	CTS2-300	CTS2-600	CTS2-1250
Voltage Gain (at maximum level setting) 4/8 Ohm, 70 V and 100 V Operation	34 dB		
Frequency Response (8 Ohms, 20 Hz - 20 kHz)	±0.25 dB		
Signal to Noise Ratio (ref. rated power, (8 Ohms, 20 Hz - 20 kHz))	>108 dB		
Total Harmonic Distortion (at full rated power, from 20 Hz - 20 kHz)	0.35%		
Intermodulation Distortion (60 Hz and 7 kHz at 4:1, from - 30 dB to full rated Power)	≤0.35%		
Damping Factor (20 Hz to 100 Hz)	>1000		
Crosstalk (below rated power, 20 Hz to 1 kHz)	>80 dB		
Common Mode Rejection (20 Hz to 1 kHz, typical)	>70 dB		
DC Output Offset (with inputs shorted)	±10 mV		
Input Impedance (Nominally balanced, nominally unbalanced)	10 kOhms, 5 kOhms		
Maximum Input Level Before Compression	+20 dBU		
Maximum Input Level Before Clipping	+26 dBU		
Required AC Mains (±10%)	100 V - 240 V ~ 50/60 Hz		
Cooling	Continuously variable speed forced air, front-to-back airflow		
Load Impedance Stereo/Dual Mode	2 - 16 Ohms; 70 Vrms and 100 Vrms		
Load Impedance Bridge Mono	4 - 16 Ohms; 140 Vrms and 200 Vrms		
Maximum Fan Noise (re dB SPL @ 1M)	45	45	47
Weight	18.8 lbs (8.53 kg)	18.8 lbs (8.53 kg)	20.1 lbs (9.12 kg)
IEC Power Connector	15A IEC	15A IEC	15A IEC

Table 14 Performance Specifications for Network

	CTS2-300N	CTS2-600N	CTS2-1250N	CTS2-2400N
Voltage Gain (at maximum level setting) 4/8 Ω, 70 Vrms and 100 Vrms Operation	34 dB			
Frequency Response (8 Ω, 20 Hz - 20 kHz)	±0.25 dB			
BLU link Signal-to-Noise Ratio (ref. rated power, 8 Ω, 20 Hz - 20 kHz)	>108 dB			
Total Harmonic Distortion (at full rated power, from 20 Hz - 20 kHz)	0.35%			
Analog Input Signal to Noise Ratio (ref. rated power, 8 Ω, 20 Hz - 20 kHz)	>104 dB			
Intermodulation Distortion (60 Hz and 7 kHz at 4:1, from - 30dB to full rated power)	≤0.35%			
Damping Factor (20 Hz to 100 Hz)	>1000	>1000	>1500	>5000
Crosstalk (below rated power, 20 Hz to 1 kHz)	>80 dB			
Common Mode Rejection (20 Hz to 1 kHz, typical)	>80 dB			
DC Output Offset (with inputs shorted)	±10 mV			
Input Impedance (Nominally balanced, nominally unbalanced)	10 kΩ, 5 kΩ			
Maximum Input Level (Low Gain Mode)	+20 dBU			
Required AC Mains (±10%)	100Vrms - 240Vrms~ 50/60Hz			
Cooling	Continuously variable speed forced air, front-to-back airflow			
Power Supply Connector	15A IEC Connector; CTS2-2400N uses a 20 A IEC connector.			
Load Impedance Stereo/Dual Mode	2Ω - 16Ω; 70Vrms and 100Vrms			
Load Impedance Bridge Mono	4Ω - 16Ω; 140Vrms and 200Vrms			
Maximum Fan Noise (re dB SPL @ 1M)	45	45	47	–
Weight	18.8 lbs (8.53 kg)	18.8 lbs (8.53 kg)	20.1 lbs (9.12 kg)	24 lbs (10.9 kg)

AC Power Draw and Thermal Dissipation

AC Power Draw and Thermal Dissipation:

Pink noise 12 dB crest factor, bandwidth limited 22 Hz to 22 kHz.

Typical line impedance used.

Data based on all channels driven.

Table 15 CTS2 300 - Bridge

CTS2 300 - Bridge									
		120 V~ 60 Hz				230 V~ 50 Hz			
Condition	Load	Line Current (amps)	Power Dissipated as Heat			Line Current (amps)	Power Dissipated as Heat		
			watts	BTU	kcal/hr		watts	BTU	kcal/hr
At Idle Awake	N/A	0.6	70	239	60	0.4	70	240	60
1/8 Power Pink Noise Typical of program material just at clip	4 ohms	1.0	80	273	69	0.6	83	283	71
	8 ohms	1.4	86	294	74	0.8	88	300	76
	16 ohms	1.4	80	274	69	0.8	84	287	72
	140V (32.67 ohms)	1.3	78	265	67	0.8	80	273	69
	200V (66.67 ohms)	1.3	78	267	67	0.8	80	274	69
1/3 Power Pink Noise Typical of program material at extreme clip	4 ohms	1.8	107	364	92	1.0	102	348	88
	8 ohms	2.8	126	430	108	1.5	117	400	101
	16 ohms	2.7	108	367	93	1.4	101	345	87
	70V (32.67 ohms)	2.6	101	345	87	1.4	95	323	81
	100V (66.67 ohms)	2.6	99	338	85	1.4	94	321	81

Table 16 CTS2-300 - Dual

CTS2-300 - Dual									
		120 V~ 60 Hz				230 V~ 50 Hz			
Condition	Load	Line Current (amps)	Power Dissipated as Heat			Line Current (amps)	Power Dissipated as Heat		
			watts	BTU	kcal/hr		watts	BTU	kcal/hr
At Idle Awake	N/A	0.6	70	238	60	0.4	70	238	60
1/8 Power Pink Noise Typical of program material just at clip	2 ohms	1.0	77	262	66	0.6	79	269	68
	4 ohms	1.4	84	287	72	0.8	84	288	73
	8 ohms	1.4	79	271	68	0.8	81	277	70
	70V (16.33 ohms)	1.3	79	268	68	0.8	80	273	69
	100V (33.33 ohms)	1.4	81	275	69	0.8	81	277	70
1/3 Power Pink Noise Typical of program material at extreme clip	2 ohms	1.8	99	338	85	1.0	96	329	83
	4 ohms	2.9	118	403	102	1.5	111	380	96
	8 ohms	2.6	102	347	87	1.4	96	327	83
	70V (16.33 ohms)	2.8	104	356	90	1.3	93	317	80
	100V (33.33 ohms)	2.6	105	358	90	1.4	98	336	85

Table 17 CTS2-300N - Bridge

CTS2-300N - Bridge									
		120 VAC / 60 Hz				230 VAC / 50 Hz			
Condition	Load	"Line current (amps)"	Power Dissipated as Heat			"Line current (amps)"	Power Dissipated as Heat		
			watts	BTU	kcal/hr		watts	BTU	kcal/hr
At Idle Awake	N/A	0.6	67	229	58	0.4	68	231	58
1/8 Power Pink Noise Typical of program material just at clip	4Ω	1.1	86	293	74	0.6	83	284	72
	8Ω	1.4	88	300	76	0.8	86	293	74
	16Ω	1.4	83	282	71	0.7	78	267	67
	140V (32.67Ω)	1.3	78	265	67	0.7	74	252	64
	200V (66.67Ω)	1.3	76	260	66	0.7	72	246	62
1/3 Power Pink Noise Typical of program material at extreme clip	4Ω	1.9	108	370	93	1.0	105	357	90
	8Ω	2.7	113	387	98	1.4	106	363	92
	16Ω	2.7	99	339	85	1.3	89	305	77
	140V (32.67Ω)	2.4	86	295	74	1.3	82	280	70
	200V (66.67Ω)	2.5	87	295	74	1.3	80	273	69

AC Power Draw and Thermal Dissipation

Table 18 CTS2-300N - Dual

CTS2-300N - Dual									
		120 VAC / 60 Hz				230 VAC / 50 Hz			
Condition	Load	"Line current (amps)"	Power Dissipated as Heat			"Line current (amps)"	Power Dissipated as Heat		
			watts	BTU	kcal/hr		watts	BTU	kcal/hr
At Idle Awake	N/A	0.6	70	240	60	0.4	68	231	58
1/8 Power Pink Noise Typical of program material just at clip	2Ω	1.1	85	291	73	0.6	83	284	72
	4Ω	1.4	89	304	77	0.8	85	289	73
	8Ω	1.4	83	282	71	0.7	79	269	68
	70V (16.33Ω)	1.3	78	265	67	0.7	75	256	65
	100V (33.33Ω)	1.3	77	263	66	0.7	73	248	63
1/3 Power Pink Noise Typical of program material at extreme clip	2Ω	1.9	109	373	94	1.0	104	356	90
	4Ω	2.7	113	387	98	1.4	105	359	90
	8Ω	2.5	99	339	85	1.3	93	316	80
	70V (16.33Ω)	2.5	89	304	77	1.3	82	279	70
	100V (33.33Ω)	2.5	82	280	70	1.3	81	276	69

Table 19 CTS2-600 - Bridge

CTS2-600 - Bridge									
		120 V~ 60 Hz				230 V~ 50 Hz			
Condition	Load	Line Current (amps)	Power Dissipated as Heat			Line Current (amps)	Power Dissipated as Heat		
			watts	BTU	kcal/hr		watts	BTU	kcal/hr
At Idle Awake	N/A	0.6	70	239	60	0.4	73	249	63
1/8 Power Pink Noise Typical of program material just at clip	2 ohms	1.5	93	318	80	0.8	97	330	83
	4 ohms	2.2	109	372	94	1.2	104	355	89
	8 ohms	2.1	101	345	87	1.1	94	320	81
	70V (16.33 ohms)	2.1	98	334	84	1.1	92	313	79
	100V (33.33 ohms)	2.1	92	316	80	1.1	90	308	78
1/3 Power Pink Noise Typical of program material at extreme clip	2 ohms	2.9	143	487	123	1.5	138	472	119
	4 ohms	4.8	174	592	149	2.6	171	585	147
	8 ohms	4.5	143	487	123	2.4	138	470	119
	70V (16.33 ohms)	4.5	143	488	123	2.4	135	462	116
	100V (33.33 ohms)	4.5	130	442	112	2.3	125	425	107

Table 20 CTS2-600 - Dual

CTS2-600 - Dual									
		120 V~ 60 Hz				230 V~ 50 Hz			
Condition	Load	Line Current (amps)	Power Dissipated as Heat			Line Current (amps)	Power Dissipated as Heat		
			watts	BTU	kcal/hr		watts	BTU	kcal/hr
At Idle Awake	N/A	0.6	72	246	62	0.4	70	240	60
1/8 Power Pink Noise Typical of program material just at clip	2 ohms	1.5	93	318	80	0.8	91	310	78
	4 ohms	2.2	106	362	91	1.2	99	339	85
	8 ohms	2.1	95	324	82	1.1	90	307	77
	70V (16.33 ohms)	2.1	94	320	81	1.1	89	304	77
	100V (33.33 ohms)	2.1	93	318	80	1.1	87	297	75
1/3 Power Pink Noise Typical of program material at extreme clip	2 ohms	2.9	133	454	114	1.5	126	430	108
	4 ohms	4.7	156	533	134	2.4	147	502	126
	8 ohms	4.5	131	448	113	2.4	125	427	108
	70V (16.33 ohms)	4.5	132	450	113	2.4	123	421	106
	100V (33.33 ohms)	4.5	127	435	110	2.4	121	413	104

Table 21 CTS2-600N - Bridge

CTS2-600N - Bridge									
		120 VAC / 60 Hz				230 VAC / 50 Hz			
Condition	Load	"Line current (amps)"	Power Dissipated as Heat			"Line current (amps)"	Power Dissipated as Heat		
			watts	BTU	kcal/hr		watts	BTU	kcal/hr
At Idle Awake	N/A	0.6	71	241	61	0.4	66	226	57
1/8 Power Pink Noise Typical of program material just at clip	4Ω	1.4	90	308	78	0.8	91	311	78
	8Ω	2.2	101	344	87	1.2	101	344	87
	16Ω	2.1	94	321	81	1.1	92	314	79
	140Vrms (16Ω)	2.1	93	318	80	1.1	91	312	79
	200Vrms (33.33Ω)	2.0	86	295	74	1.1	84	287	72
1/3 Power Pink Noise Typical of program material at extreme clip	4Ω	2.8	128	438	110	1.6	133	453	114
	8Ω	4.8	157	536	135	2.5	148	505	127
	16Ω	4.6	130	444	112	2.3	118	403	102
	140V (16Ω)	4.6	125	427	108	2.3	117	399	101
	200V (33.33Ω)	4.4	106	363	91	2.3	105	358	90

AC Power Draw and Thermal Dissipation

Table 22 CTS2-600N - Dual

CTS2-600N - Dual									
		120 VAC / 60 Hz				230 VAC / 50 Hz			
Condition	Load	"Line current (amps)"	Power Dissipated as Heat			"Line current (amps)"	Power Dissipated as Heat		
			watts	BTU	kcal/hr		watts	BTU	kcal/hr
At Idle Awake	N/A	0.6	70	240	60	0.4	71	241	61
1/8 Power Pink Noise Typical of program material just at clip	2Ω	1.6	102	348	88	0.9	93	319	80
	4Ω	2.3	107	364	92	1.2	104	355	89
	8Ω	2.2	98	333	84	1.2	96	328	83
	70V (8Ω)	2.2	96	329	83	1.2	94	322	81
	100V (16.67Ω)	2.0	87	297	75	1.1	87	298	75
1/3 Power Pink Noise Typical of program material at extreme clip	2Ω	3.0	142	486	122	1.6	134	456	115
	4Ω	4.8	161	549	139	2.5	153	521	131
	8Ω	4.5	131	446	112	2.4	129	441	111
	70V (8Ω)	4.5	130	442	111	2.3	122	417	105
	100V (16.67Ω)	4.5	122	417	105	2.4	109	370	93

Table 23 CTS2-1250 - Bridge

CTS2-1250 - Bridge									
		120 V~ 60 Hz				230 V~ 50 Hz			
Condition	Load	Line Current (amps)	Power Dissipated as Heat			Line Current (amps)	Power Dissipated as Heat		
			watts	BTU	kcal/hr		watts	BTU	kcal/hr
At Idle Awake	N/A	0.8	96	329	83	0.5	91	311	78
1/8 Power Pink Noise Typical of program material just at clip	4 ohms	4.1	175	598	151	2.1	141	483	122
	8 ohms	4.2	142	485	122	2.2	127	434	109
	16 ohms	4.1	155	529	133	2.0	105	360	91
	140V (8 ohms)	3.9	143	486	123	2.1	141	481	121
	200V (16 ohms)	3.6	111	378	95	2.1	132	451	114
1/3 Power Pink Noise Typical of program material at extreme clip	4 ohms	9.6	276	943	238	5.0	233	796	201
	8 ohms	9.8	218	743	187	4.8	211	719	181
	16 ohms	9.5	204	696	176	4.9	209	715	180
	140V (8 ohms)	9.1	224	763	192	4.6	200	682	172
	200V (16 ohms)	8.7	160	546	138	4.7	208	711	179

Table 24 CTS2-1250 - Dual

CTS2-1250 - Dual									
		120 V~ 60 Hz				230 V~ 50 Hz			
Condition	Load	Line Current (amps)	Power Dissipated as Heat			Line Current (amps)	Power Dissipated as Heat		
			watts	BTU	kcal/hr		watts	BTU	kcal/hr
At Idle Awake	N/A	0.8	97	330	83	0.5	91	311	78
1/8 Power Pink Noise Typical of program material just at clip	2 ohms	6.2	198	675	170	3.0	182	621	157
	4 ohms	5.1	143	489	123	2.5	138	469	118
	8 ohms	4.2	106	361	91	2.3	154	526	133
	70V (4 ohms)	4.1	132	450	113	2.1	126	430	108
	100V (8 ohms)	3.8	122	418	105	2.1	143	487	123
1/3 Power Pink Noise Typical of program material at extreme clip	2 ohms	11.4	275	938	237	6.4	314	1072	270
	4 ohms	10.4	220	750	189	5.2	235	802	202
	8 ohms	9.4	221	754	190	4.6	179	611	154
	70V (4 ohms)	9.0	260	886	223	4.6	197	672	169
	100V (8 ohms)	8.7	196	669	169	4.5	176	602	152

Table 25 CTS2-1250N - Bridge

CTS2-250N - Bridge									
		120 VAC / 60 Hz				230 VAC / 50 Hz			
Condition	Load	"Line current (amps)"	Power Dissipated as Heat			"Line current (amps)"	Power Dissipated as Heat		
			watts	BTU	kcal/hr		watts	BTU	kcal/hr
At Idle Awake	N/A	0.8	101	345	87	0.5	100	340	86
1/8 Power Pink Noise Typical of program material just at clip	4Ω	4.1	151	514	130	2.2	150	511	129
	8Ω	3.9	127	435	110	2.0	116	395	100
	16Ω	3.8	115	393	99	1.9	106	361	91
	140V (8Ω)	4.2	162	552	139	2.1	126	431	109
	200V (16Ω)	3.9	142	485	122	2.0	118	401	101
1/3 Power Pink Noise Typical of program material at extreme clip	4Ω	9.9	279	951	240	4.9	259	883	223
	8Ω	9.2	238	812	205	4.8	206	703	177
	16Ω	9.2	233	797	201	4.7	193	660	166
	140V (8Ω)	8.7	224	765	193	4.6	188	641	162
	200V (16Ω)	9.4	233	797	201	4.5	183	626	158

AC Power Draw and Thermal Dissipation

Table 26 CTS2-1250N - Dual

CTS2-1250N - Dual									
		120 VAC / 60 Hz				230 VAC / 50 Hz			
Condition	Load	"Line current (amps)"	Power Dissipated as Heat			"Line current (amps)"	Power Dissipated as Heat		
			watts	BTU	kcal/hr		watts	BTU	kcal/hr
At Idle Awake	N/A	0.8	101	345	87	0.5	99	338	85
1/8 Power Pink Noise Typical of program material just at clip	2Ω	5.0	171	584	147	2.7	156	532	134
	4Ω	4.6	155	530	134	2.4	142	486	123
	8Ω	4.2	136	465	117	2.0	108	369	93
	70V (4Ω)	4.6	131	447	113	2.3	108	369	93
	100V (8Ω)	4.4	120	410	103	2.1	111	380	96
1/3 Power Pink Noise Typical of program material at extreme clip	2Ω	10.1	261	890	224	5.3	255	871	220
	4Ω	10.0	229	780	197	4.8	210	717	181
	8Ω	9.1	176	602	152	4.7	203	694	175
	70V (4Ω)	9.8	210	715	180	4.9	176	602	152
	100V (8Ω)	9.1	174	593	150	4.6	165	562	142

Table 27 CTS2- 2400N - Bridge

CTS2- 2400N - Bridge									
		120 VAC / 60 Hz				230 VAC / 50 Hz			
Condition	Load	"Line current (amps)"	Power Dissipated as Heat			"Line current (amps)"	Power Dissipated as Heat		
			watts	BTU	kcal/hr		watts	BTU	kcal/hr
At Idle Awake	N/A	1.8	179	612	154	1.6	201	685	173
1/8 Power Pink Noise Typical of program material just at clip	4Ω	10.7	523	1785	450	6.4	545	1859	469
	8Ω	7.3	353	1204	304	4.3	367	1252	316
	16Ω	4.5	239	817	206	2.8	260	888	224
	140V (32.67Ω)	8.3	401	1367	345	4.9	433	1477	372
	200V (66.67Ω)	8.3	362	1237	312	5.0	384	1310	330
1/3 Power Pink Noise Typical of program material at extreme clip	4Ω	23.6	881	3007	758	12.2	979	3341	842
	8Ω	16.9	611	2085	526	9.3	568	1939	489
	16Ω	9.2	286	975	246	5.0	331	1130	285
	140V (32.67Ω)	18.2	688	2348	592	10.0	657	2243	565
	200V (66.67Ω)	18.8	573	1954	493	10.5	584	1994	503

Table 28 CTS2-2400N - Dual

CTS2-2400N - Dual									
		120 VAC / 60 Hz				230 VAC / 50 Hz			
Condition	Load	"Line current (amps)"	Power Dissipated as Heat			"Line current (amps)"	Power Dissipated as Heat		
			watts	BTU	kcal/hr		watts	BTU	kcal/hr
At Idle Awake	N/A	1.8	179	612	154	1.6	201	685	173
1/8 Power Pink Noise Typical of program material just at clip	2Ω	10.7	523	1785	450	6.4	545	1859	469
	4Ω	7.3	353	1204	304	4.3	367	1252	316
	8Ω	4.5	239	817	206	2.8	260	888	224
	70V (16.33Ω)	8.3	401	1367	345	4.9	433	1477	372
	100V (33.33Ω)	8.3	362	1237	312	5.0	384	1310	330
1/3 Power Pink Noise Typical of program material at extreme clip	2Ω	23.6	881	3007	758	12.2	979	3341	842
	4Ω	16.9	611	2085	526	9.3	568	1939	489
	8Ω	9.2	286	975	246	5.0	331	1130	285
	70V (16.33Ω)	18.2	688	2348	592	10.0	657	2243	565
	100V (33.33Ω)	18.8	573	1954	493	10.5	584	1994	503

Getting Technical Support and Service

If you are experiencing any difficulties, contact Federal Signal Customer Support at: 800-344-4634 or 708-534-3400 or Technical Support at: 800-524-3021 or 708-534-3400 extension 7329 or through e-mail at: techsupport@fedsig.com. For instruction manuals and information on related products, visit: <http://www.fedsig.com/>

The Federal Signal factory provides technical assistance with any problems that cannot be handled locally.

Any units returned to Federal Signal for service, inspection, or repair must be accompanied by a Return Material Authorization (RMA). Obtain a RMA from a local Distributor or Manufacturer's Representative.

Provide a brief explanation of the service requested, or the nature of the malfunction.

Address all communications and shipments to the following:

Federal Signal Corporation
Service Department
2645 Federal Signal Drive
University Park, IL 60484-3167

Product Registration

Online registration is available at www.fedsig.com/product-registration



FEDERAL SIGNAL
Safety and Security Systems

2645 Federal Signal Drive
University Park, Illinois 60484-3617

www.fedsig.com

Customer Support	800-344-4634 • +1 708 534-3400
Technical Support	800-524-3021 • +1 708 534-3400



FEDERAL SIGNAL
Safety and Security Systems

2645 Federal Signal Drive
University Park, Illinois 60484-3617

www.fedsig.com

Customer Support

800-344-4634 • +1 708 534-3400

Technical Support

800-524-3021 • +1 708 534-3400