



PRODUCT CATALOG



MAYHEW

CHISELS

SCRAPERS

PUNCHES

SPECIALTY

PRY BARS

PNEUMATIC



MAYHEW™
Since 1856
The Pros Know

MAYHEW™

Since 1856

The Pros Know

Divided into two sections, this catalog lists the full breadth of MayheWPro (black-tabbed pages) and MayheWSelect (red-tabbed pages) products. Within each section, our high-quality tools are categorized by the following:



Pro Line

- Dominator
- Hard Cap
- 150
- Chisels
- Punches
- Pry Bars
- Scrapers
- Specialty
- Pneumatic
- Sets and Kits





Select Line

- Chisels
- Punches
- Pry Bars
- Scrapers
- Hand Guarded
- Picks, Awls, Hooks, Other
- Specialty
- Pneumatic
- Inspection
- Sets and Kits

For further information about any of our tools listed, please contact your sales representative or call us directly: 1.800.872.0037

Table of Contents

Pro Line	
	Dominator 2
	Pry Bars 8
	Scrapers 12
	Chisels 13
	Punches 14
	Steel Sets/Kits 18
	Specialty & Extractors 26
	Retail Displays 28
	Brass Sets/Kits 30
	150 35
	Hard Cap 36
	Hollow Punch Sets 37
	Automotive/Specialty 43
	Pneumatic 44

Select Line	
	Chisels 48
	Punches 51
	Pry Bars 53
	Handguarded 55
	Specialty 56
	Inspection 58
	Sets/Kits 60



The Dominator®

Go Ahead and Whack It!

Dominator tools mean business. With a hardened and tempered steel shaft extending through the handle and strikeable capped end, Dominator delivers the prying power and force you need to take on the toughest jobs.

Some Jobs are Tough; These Tools are Tougher

Dominator is the workhorse of the MayhewPro™ series. Uniquely designed for unparalleled strength and durability, this exclusive collection of professional-grade capped end pry bars and specialty tools stands up to punishment just as easily as it dishes it out.



- Capped end is in direct contact with the shaft and allows the user to strike the tool without damaging the handle
- Patented two-composite handle is ergonomically designed, providing superior comfort and grip

- Hardened, tempered-steel shaft runs from the cutting edge through the handle, delivering maximum durability and prying power





Pry Bars

- Used for lifting and prying
- Available in both curved and straight blade styles
- Ergonomically designed handle with a capped end that is forged through the handle for unparalleled strength and durability
- Heat treated along the entire length of the steel
- Black oxide finish for additional rust protection
- Made in the USA

Item	Description	UPC Code	OAL	Body Size	Body Type	Blade Width	Blade Style	Weight (Lbs)	Pkg. Type
40128	36-S Dominator Straight Screwdriver Pry Bar	0 45256 40128 7	36	5/8	Square	N/A	Straight	4.00	Bulk
40129	42-S Dominator Straight Screwdriver Pry Bar	0 45256 40129 4	42	5/8	Square	N/A	Straight	4.61	Bulk
40138	36-C Dominator 36" Curved Screwdriver Pry Bar	0 45256 40138 6	36	5/8	Square	N/A	Curved	3.95	Bulk
40139	42-C Dominator 42" Curved Screwdriver Pry Bar	0 45256 40139 3	42	5/8	Square	N/A	Curved	4.60	Bulk
40160	48-C Dominator 48" Curved Screwdriver Pry Bar	0 45256 40160 7	48	3/4	Square	N/A	Curved	7.95	Bulk
40162	58-C Dominator 58" Curved Screwdriver Pry Bar	0 45256 40162 1	58	3/4	Square	N/A	Curved	9.27	Bulk
40164	44-C Dominator 44" Curved Screwdriver Pry Bar	0 45256 40164 5	44	7/8	Square	N/A	Curved	9.80	Bulk
40166	45-C Dominator 45" Curved Screwdriver Pry Bar	0 45256 40166 9	45	1	Square	N/A	Curved	13.20	Bulk
40170	Dominator 30" Modified Die Bar	0 45256 40170 6	30	1/2	Square	N/A	N/A	2.39	Bulk
40172	Dominator 30" Modified Rolling Head Pry Bar	0 45256 40172 0	30	1/2	Square	N/A	N/A	3.26	Bulk
60137	5-C Dominator	0 45256 60137 3	10	3/8	Square	N/A	Curved	0.66	Clamshell
60140	7-C Dominator	0 45256 60140 3	12	3/8	Square	N/A	Curved	0.74	Clamshell
60141	7-S Dominator	0 45256 60141 0	12	3/8	Square	N/A	Straight	0.74	Clamshell
60143	12-S Dominator	0 45256 60143 4	17	3/8	Square	N/A	Straight	0.93	Clamshell
60144	12-C Dominator	0 45256 60144 1	17	3/8	Square	N/A	Curved	0.93	Clamshell
60145	18-S Dominator	0 45256 60145 8	25	1/2	Square	N/A	Straight	2.03	Clamshell
60146	18-C Dominator	0 45256 60146 5	25	1/2	Square	N/A	Curved	2.00	Clamshell
60147	24-S Dominator	0 45256 60147 2	31	1/2	Square	N/A	Straight	2.45	Clamshell
60148	24-C Dominator	0 45256 60148 9	31	1/2	Square	N/A	Curved	2.45	Clamshell
80029	Dominator Bar Vault	0 45256 80029 5	14	N/A	N/A	N/A	N/A	12.40	Bulk

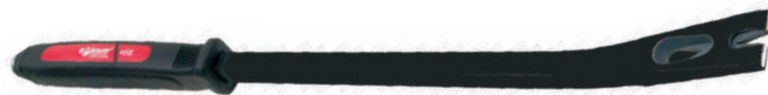

Ripping Chisel

- Used to rip apart building materials and pull apart studs
- Has handy nail slots to help remove stubborn nails when separating wood
- Black oxide finish for additional rust protection
- Made in the USA

Item	Description	UPC Code	OAL	Body Size	Body Type	Blade Width	Blade Style	Weight (Lbs)	Pkg. Type
60305	30" Dominator Ripping Chisel	0 45256 60305 6	30	3/4	Square	N/A	N/A	4.85	Clamshell

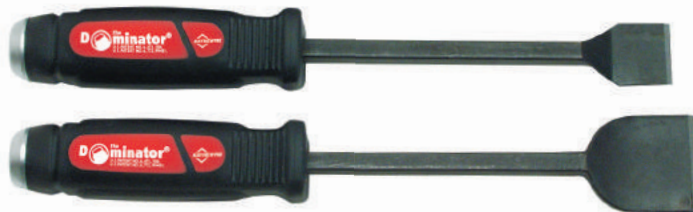

Scrapers – Straight

- Used for a multitude of applications, such as removing gaskets, rust, paint, carbon buildup, and floor tile
- Blades are ground for a sharp edge and can be resharpened after heavy use to return the cutting edge to its original sharpness
- Capped end in direct contact with the tempered steel shaft
- Patented, two-composite ergonomically designed handle provides a comfortable and secure grip
- Black oxide finish for additional rust protection
- Made in the US

Item	Description	UPC Code	OAL	Body Size	Body Type	Blade Width	Blade Style	Weight (Lbs)	Pkg. Type
42004	1/2" Dominator HD Scraper	0 45256 42004 2	12	3/8	Square	1/2	N/A	0.56	Bulk
42005	3/4" Dominator HD Scraper	0 45256 42005 9	12	3/8	Square	3/4	N/A	0.58	Bulk
42006	1" Dominator HD Scraper	0 45256 42006 6	12	3/8	Square	1	N/A	3.89	Bulk
42007	1-1/2" Dominator HD Scraper	0 45256 42007 3	12	3/8	Square	1-1/2	N/A	1.00	Bulk
62006	1" Dominator HD All Purpose Scraper	0 45256 62006 0	10.5	3/8	Square	1	N/A	0.66	Clamshell
42018	2" Dominator HD Long Scraper	0 4525642018 9	14.5	1/2	Square	2	N/A	1.03	Bulk
42019	3" Dominator HD Long Scraper	0 4525642019 6	17	5/8	Square	3	N/A	1.62	Bulk



Carbon Scrapers – Angled

- U.S. Patent No. D594720
- Used for a multitude of applications, such as removing gaskets, rust, paint, carbon buildup, and floor tile
- Blades are ground for a sharp edge and can be resharpened after heavy use to return the cutting edge to sharpness
- Blade is offset for hand clearance and better scraping force in hard-to-reach places
- Capped end in direct contact with the tempered steel shaft
- Patented, two-composite ergonomically designed handle provides a comfortable and secure grip
- Black oxide finish for additional rust protection
- Made in the USA with U.S. and global components

Item	Description	UPC Code	OAL	Body Size	Body Type	Blade Width	Blade Style	Weight (Lbs)	Pkg. Type
42014	1/2" Dominator Angled Scraper	0 45256 42014 1	12	3/8	Square	1/2	N/A	0.65	Bulk
42015	3/4" Dominator Angled Scraper	0 45256 42015 8	12	3/8	Square	3/4	N/A	0.67	Bulk
42016	1" Dominator Angled Scraper	0 45256 42016 5	12	3/8	Square	1	N/A	0.68	Bulk
42017	1-1/2" Dominator Angled Scraper	0 45256 42017 2	12	3/8	Square	1-1/2	N/A	0.69	Bulk



Hooks & Picks

- Used for a wide variety of applications, such as automotive and electrical work in confined spaces, scribing lines, o-ring and cotter pin removal, and to break radiator connections
- Made of larger shank steel for heavy-duty applications
- Available in multiple shapes and angles for the perfect tool for the application
- Black oxide finish for additional rust protection
- Made in the US

Item	Description	UPC Code	OAL	Body Size	Body Type	Blade Width	Blade Style	Weight (Lbs)	Pkg. Type
42000	Dominator HD Scratch Awl	0 45256 42000 4	10	1/4	Round	N/A	N/A	0.35	Bulk
42001	Dominator HD 90 Degree Hook	0 45256 42001 1	10	1/4	Round	N/A	N/A	0.35	Bulk
42003	Dominator HD Complex Hook	0 45256 42003 5	10	1/4	Round	N/A	N/A	0.35	Bulk
42008	Dominator HD C-Hook	0 45256 42008 0	10	1/4	Round	N/A	N/A	0.36	Bulk
42009	Dominator HD 15 Degree Hook	0 45256 42009 7	10	1/4	Round	N/A	N/A	0.36	Bulk
42010	Dominator HD 45 Degree Hook	0 45256 42010 3	10	1/4	Round	N/A	N/A	0.36	Bulk
42011	Dominator HD 45 Degree Long Hook	0 45256 42011 0	16	1/4	Round	N/A	N/A	0.44	Bulk
42012	Dominator HD 60 Degree Long Hook	0 45256 42012 7	16	1/4	Round	N/A	N/A	0.44	Bulk
42013	Dominator HD 90 Degree Long Hook	0 45256 42013 4	16	1/4	Round	N/A	N/A	0.44	Bulk
42022	Dominator Cotter Pin Puller	0 45256 42022 6	10	1/4	Round	N/A	N/A	0.37	Bulk
42023	Dominator 45 Degree Long Hook	0 45256 42023 3	10	1/4	Round	N/A	N/A	0.37	Bulk
42024	Dominator 90 Degree Long Hook	0 45256 42024 0	10	1/4	Round	N/A	N/A	0.37	Bulk
62002	Dominator HD Scratch Awl & Pick	0 45256 62002 2	10	1/4	Round	N/A	N/A	0.42	Clamshell
42002MAY	Dominator HD Curved Hook	0 45256 42002 8	10	1/4	Round	N/A	Curved	0.35	Bulk



Weld Wakker™

- Used to break apart spot welds or bonded panels
- Strikeable handle end cap and side edge of tool
- Patented, two-composite soft-grip handle with metal end cap for striking
- Unique two-sided cutting bevels
- Black oxide finish for additional rust protection
- Made in the US

Item	Description	UPC Code	OAL	Body Size	Body Type	Blade Width	Blade Style	Weight (Lbs)	Pkg. Type
42020	3/8" X 11.75" Dominator Weld Wakker	0 45256 42020 2	12-1/4	3/8	Square	1	N/A	0.66	Bulk
42021	1/2" X 14.5" Dominator Weld Wakker	0 45256 42021 9	15-1/4	1/2	Square	1-1/4	N/A	1.19	Bulk



Mayhew Steel Products, Inc.
199 Industrial Blvd.
Turners Falls, MA 01376

U.S. Toll-Free Customer Service: 800-872-0037
Visit us online at www.Mayhew.com
Always wear safety goggles when using hand tools.

Version 2.2016
For the latest version, visit us
online at www.Mayhew.com

The Pros Know

Dominator

Pry Bars

Scrapers

Chisels

Punches

Steel Sets/
Kits

Specialty &
Extractors

Retail
Displays

Brass Sets/
Kits

150

Hard Cap

Hollow Punch
Sets

Automotive/
Specialty

Pneumatic

5

Sets and Kits

Dominator
 Pry Bars
 Scrapers
 Chisels
 Punches
 Steel Sets/
 Kits
 Specialty &
 Extractors
 Retail
 Displays
 Brass Sets/
 Kits
 150
 Hard Cap
 Hollow Punch
 Sets
 Automotive/
 Specialty
 Pneumatic

Item	Description	UPC Code	OAL	Body Size	Body Type	Blade Width	Blade Style	Weight (Lbs)	Pkg. Type
61353	2 Pc Dominator Screwdriver Pry Bar Set	0 45256 61353 6	N/A	N/A	Square	N/A	N/A	4.31	Tray
61354	3 Pc Dominator Straight Screwdriver Pry Bar Set 60141 – 7-S Dominator 60143 – 12-S Dominator 60145 – 18-S Dominator	0 45256 61354 3	N/A	N/A	Square	N/A	Straight	4.02	Tray
61355	3 Pc Dominator Curved Screwdriver Pry Bar Set 60140 – 7-C Dominator 60144 – 12-C Dominator 60146 – 18-C Dominator	0 45256 61355 0	N/A	N/A	Square	N/A	Curved	4.03	Tray
61356	3 Pc Dominator HD Pry Bar Set 40138 – 36-C Dominator 36" Curved Screwdriver Pry Bar 60145 – 18-S Dominator 60148 – 24-C Dominator	0 45256 61356 7	N/A	N/A	Square	N/A	N/A	9.10	Tray
61361	2 Pc Dominator Specialty Pry Bar Set 40170 – Dominator 30" Modified Die Bar 40172 – Dominator 30" Modified Rolling Head Pry Bar	0 45256 61361 1	N/A	N/A	Square	N/A	N/A	5.65	Tray
61366	5 Pc Dominator Curved Pry Bar Set 60137 – 5-C Dominator 60140 – 7-C Dominator 60144 – 12-C Dominator 60146 – 18-C Dominator 60148 – 24-C Dominator	0 45256 61366 6	N/A	N/A	Square	N/A	Curved	7.30	Tray
80027	Dominator 8 Pc Large Pry Bar Display 40138 – 36-C Dominator 36" Curved Screwdriver Pry Bar 40139 – 42-C Dominator 42" Curved Screwdriver Pry Bar 40160 – 48-C Dominator 48" Curved Screwdriver Pry Bar 40162 – 58-C Dominator 58" Curved Screwdriver Pry Bar	0 45256 80027 1	N/A	N/A	Square	N/A	N/A	3.96	Rack
60001	4 Pc Dominator HD Carbon Scraper Set 42004 – 1/2" Dominator HD Carbon Scraper 42005 – 3/4" Dominator HD Carbon Scraper 42006 – 1" Dominator HD Carbon Scraper 42007 – 1-1/2" Dominator HD Carbon Scraper	0 45256 60001 7	N/A	N/A	Square	N/A	N/A	2.50	Clamshell
60026	2 Pc Dominator HD Long Carbon Scraper Set 42018 – 2" Dominator HD Long Carbon Scraper 42019 – 3" Dominator HD Long Carbon Scraper	0 4525660026 0	N/A	N/A	Square	N/A	N/A	2.80	Clamshell
60004	4 Pc Dominator Angled Scraper Set 42014 – 1/2" Dominator HD Carbon Scraper 42015 – 3/4" Dominator HD Carbon Scraper 42016 – 1" Dominator HD Carbon Scraper 42017 – 1-1/2" Dominator HD Carbon Scraper	0 45256 60004 8	N/A	N/A	Square	N/A	N/A	2.88	Clamshell
60025	4 Pc Dominator Utility Set 42004 – 1/2" Dominator HD Carbon Scraper 42007 – 1-1/2" Dominator HD Carbon Scraper 42000 – Dominator HD Scratch Awl 42002MAY – Dominator HD Curved Hook	0 45256 60025 3	N/A	N/A	Square	N/A	N/A	2.08	Clamshell
60000	4 Pc Dominator HD Hook & Pick Set 42000 – Dominator HD Scratch Awl 42001 – Dominator HD 90 Degree Hook 42002MAY – Dominator HD Curved Hook 42003 – Dominator HD Complex Hook	0 45256 60000 0	N/A	N/A	Round	N/A	N/A	1.62	Clamshell
60002	6 Pc Dominator Professional Hook & Pick Set 42008 – Dominator HD C-Hook 42009 – Dominator HD 15 Degree Hook 42010 – Dominator HD 45 Degree Hook 42011 – Dominator HD 45 Degree Long Hook 42012 – Dominator HD 60 Degree Long Hook 42013 – Dominator HD 90 Degree Long Hook	0 45256 60002 4	N/A	N/A	Round	N/A	N/A	2.81	Clamshell
60008	4 Pc Dominator Radiator Hose Pick Set 42008 – Dominator HD C-Hook 42022 – Dominator Cotter Pin Puller 42023 – Dominator 45 Degree Long Hook 42024 – Dominator 90 Degree Long Hook	0 45256 60008 6	N/A	N/A	Round	N/A	N/A	1.69	Clamshell
60005	2 Pc Dominator Weld Wakker Set 42020 – 3/8" x 11.75" Dominator Weld Wakker 42021 – 1/2" x 14.5" Dominator Weld Wakker	0 45256 60005 5	N/A	N/A	Square	N/A	N/A	1.96	Clamshell



60000 – 4 Pc Dominator HD Hook & Pick Set



60008 – 4 Pc Dominator Radiator Hose Pick Set

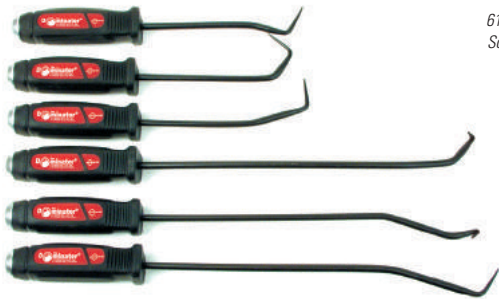

60002 – 6 Pc Dominator Professional Hook & Pick Set



60001 – 4 Pc Dominator HD Carbon Scraper Set



60004 – 4 Pc Dominator Angled Scraper Set



61353 – 2 Pc Dominator Screwdriver Pry Bar Set



61354 – 3 Pc Dominator Straight Screwdriver Pry Bar Set



61361 – 2 Pc Dominator Specialty Pry Bar Set

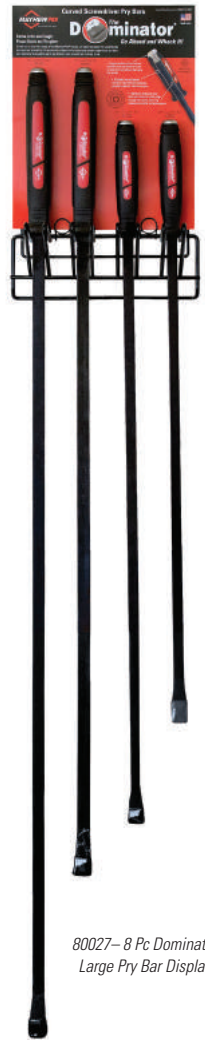

80027 – 8 Pc Dominator Large Pry Bar Display



61366 – 5 Pc Dominator Curved Pry Bar Set



60005 – 2 Pc Dominator Weld Wakker Set



60025 – 4 Pc Dominator Utility Set

Dominator

Pry Bars

Scrapers

Chisels

Punches

Steel Sets/
Kits

Specialty &
Extractors

Retail
Displays

Brass Sets/
Kits

150

Hard Cap

Hollow Punch
Sets

Automotive/
Specialty

Pneumatic

7



Mayhew Steel Products, Inc.
199 Industrial Blvd.
Turners Falls, MA 01376

U.S. Toll-Free Customer Service: 800-872-0037
Visit us online at www.Mayhew.com
Always wear safety goggles when using hand tools.

Version 2.2016
For the latest version, visit us
online at www.Mayhew.com

The Pros Know

Leverage Your Time Right... Now

This isn't about casual tinkering or an occasional repair. Professionals depend on their tools to work properly each and every time they pick them up—anything less than that amounts to lost time and revenue. The MayhewPro™ series is for the men and women who understand and depend on effectiveness, reliability, and durability for their livelihood. Backed by a lifetime warranty and more than 150 years of manufacturing experience, MayhewPro professional-grade tools are designed for unmatched, unwavering performance, ensuring you always have what you need to get the job done.



MAYHEW PRO™
Since 1856
Know What The Pros Know



Professional Grade Plated Bars

- Zinc Plated
- Meets or Exceeds ASME B107.410 specs

Item	Description	UPC Code	OAL	Body Size	Body Type	Blade Width	Weight (Lbs)	Pkg. Type
49000	1/2" x 15" Plated Jimmy Bar	0 45256 49000 7	15	1/2	Round	0.60	0.75	Bulk
49001	5/8" x 19" Plated Jimmy Bar	0 45256 49001 4	19	5/8	Round	0.75	1.45	Bulk
49003	3/4" x 25" Plated Jimmy Bar	0 45256 49003 8	25	3/4	Round	0.83	2.75	Bulk
49004	7/8" x 30" Plated Jimmy Bar	0 45256 49004 5	30	7/8	Round	1.00	4.65	Bulk
49112	18-C Plated Curved Pry Bar	0 45256 49112 7	18	1/2	Square	0.78	1.90	Bulk
49150	1/2" x 12" Plated Rolling Head Bar	0 45256 49150 9	12	1/2	Round	0.63	0.70	Bulk
49152	5/8" x 16" Rolling Head Bar	0 45256 49152 3	16	5/8	Round	0.75	1.28	Bulk
49154	3/4" x 25" Rolling Head Bar	0 45256 49154 7	25	3/4	Round	0.88	2.52	Bulk

- If you are looking for individual UPC labeling, add UL to the end of the item number (12345UL)
- If you are looking for individual Hang Tags, add HT to the end of the item number (12345HT)

Mayhew's plated rolling head and alignment pry bars feature two work ends that are preferred during vehicle assembly, disassembly and adjustment operations. Ideal for prying, positioning, lifting and aligning applications that need greater leverage. When the job is done these specialty plated pry bars are easy to clean and ready for the next heavy duty project. While perfect for the automotive mechanic, Mayhew's plated bars are also ideally suited for agriculture, mining, industrial MRO, construction, oil and gas, rigging operations and more. USA made, professional grade, lifetime warranty. Available in open stock and in three piece assorted sets.



Professional Grade Plated Bar Sets

Item	Description	UPC Code	OAL	Body Size	Body Type	Weight (Lbs)	Pkg. Type
69150	3 Pc Rolling Head Pry Bar Set 49150 – 1/2" x 12" Plated Rolling Head Bar 49152 – 5/8" x 16" Rolling Head Bar 49154 – 3/4" x 21" Rolling Head Bar	0 45256 69150 3	N/A	N/A	Round	5.05	Tray
69151	3 Pc Jimmy Bar Set 49000 – 1/2" x 15" Plated Jimmy Bar 49001 – 5/8" x 19" Plated Jimmy Bar 49003 – 3/4" x 25" Plated Jimmy Bar	0 45256 69151 0	N/A	N/A	Round	5.35	Tray
69152	3 Pc Pry Bar Set 49150 – 1/2" x 12" Plated Rolling Head Bar 49000 – 1/2" x 15" Plated Jimmy Bar 49112 – 18-C Plated Curved Pry Bar	0 45256 69152 7	N/A	N/A	Round	3.85	Tray



Mayhew Steel Products, Inc.
199 Industrial Blvd.
Turners Falls, MA 01376

U.S. Toll-Free Customer Service: 800-872-0037
Visit us online at www.Mayhew.com
Always wear safety goggles when using hand tools.

Version 2.2016
For the latest version, visit us
online at www.Mayhew.com

The Pros Know

Dominator
 Pry Bars
 Scrapers
 Chisels
 Punches
 Steel Sets/
 Kits
 Specialty &
 Extractors
 Retail
 Displays
 Brass Sets/
 Kits
 150
 Hard Cap
 Hollow Punch
 Sets
 Automotive/
 Specialty
 Pneumatic



Die Separating Bar

- Used to separate and remove die blocks and plates; pointed end to separate and curved end to help remove them
- Made in the USA

Item	Description	UPC Code	OAL	Body Size	Body Type	Blade Width	Blade Style	Weight (Lbs)	Pkg. Type
41285	30" Die Bar (Shot-Blast Finish)	0 45256 41285 6	30	5/8	Hex	0	N/A	2.95	Bulk
41280	18" Die Bar (Black Oxide Finish)	0 45256 41280 1	18	5/8	Hex	0	N/A	1.92	Bulk



Ladyfoot Pry Bar

- Rocking head used for prying in small areas; other end used to align
- Solid forged head for superior strength
- Variable lengths available for use in hard-to-reach or confined locations
- Black oxide finish for additional rust protection
- Made in the USA

Item	Description	UPC Code	OAL	Body Size	Body Type	Blade Width	Blade Style	Weight (Lbs)	Pkg. Type
40150	1/2" X 12" Ladyfoot Pry Bar	0 45256 40150 8	12	7/16	Round	0	N/A	0.46	Bulk
40152	5/8" X 16" Ladyfoot Pry Bar	0 45256 40152 2	16	5/8	Round	0	N/A	1.05	Bulk
40154	3/4" X 21" Ladyfoot Pry Bar	0 45256 40154 6	21	1-1/16	Round	0	N/A	1.99	Bulk



Line-Up Pry Bar

- Long, tapered end for aligning and adjusting metal or wood
- Angled chisel end for extra leverage when prying
- Available in a variety of lengths for work in hard-to-reach spots and more leverage
- Available in black oxide finish for additional rust protection
- Made in the USA

Item	Description	UPC Code	OAL	Body Size	Body Type	Blade Width	Blade Style	Weight (Lbs)	Pkg. Type
40000	14" Line-Up Pry Bar	0 45256 40000 6	14	1/2	Hex	5/8	N/A	0.72	Bulk
40001	16" Line-Up Pry Bar	0 45256 40001 3	16	5/8	Hex	3/4	N/A	1.21	Bulk
40002	20" Line-Up Pry Bar	0 45256 40002 0	20	3/4	Hex	7/8	N/A	2.23	Bulk
40003	24" Line-Up Pry Bar	0 45256 40003 7	24	3/4	Hex	7/8	N/A	2.76	Bulk
40022	38" Line-Up Pry Bar	0 45256 40022 8	38	3/4	Hex	3/8	N/A	4.81	Bulk
40023	42" Line-Up Pry Bar	0 45256 40023 5	42	7/8	Hex	7/16	N/A	7.34	Bulk
40024	60" Line-Up Pry Bar	0 45256 40024 2	60	1	Hex	3/8	N/A	14.23	Bulk
75004	30" Line-Up Pry Bar	0 45256 75004 0	30	7/8	Hex	1.0	N/A	4.10	Bulk



Rolling Head Pry Bar

- Long, tapered end for aligning and adjusting metal or wood
- 90 degree angled chisel end for extra leverage when prying
- Rolling head provides extra leverage and helps dislodge heavy items
- Available in variable lengths for applications in hard-to-reach locations
- Black oxide finish for additional rust protection
- Made in the USA

Item	Description	UPC Code	OAL	Body Size	Body Type	Blade Width	Blade Style	Weight (Lbs)	Pkg. Type
40100	9" Rolling Head Pry Bar	0 45256 40100 3	9	3/8	Hex	0	N/A	0.92	Bulk
40101	16" Rolling Head Pry Bar	0 45256 40101 0	16	1/2	Hex	0	N/A	0.92	Bulk
40102	18" Rolling Head Pry Bar	0 45256 40102 7	18	5/8	Hex	0	N/A	1.55	Bulk
40104	22" Rolling Head Pry Bar	0 45256 40104 1	22	3/4	Hex	0	N/A	2.75	Bulk

Dominator
 Pry Bars
 Scrapers
 Chisels
 Punches
 Steel Sets/
 Kits
 Specialty &
 Extractors
 Retail
 Displays
 Brass Sets/
 Kits
 150
 Hard Cap
 Hollow Punch
 Sets
 Automotive/
 Specialty
 Pneumatic
 10



76295 – 4 Pc Utility Pry Bar Set

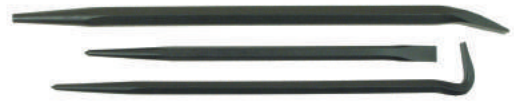

61306 – 3 Pc Line-Up Pry Bar Set

Pry Bar Sets

Item	Description	UPC Code	OAL	Body Size	Body Type	Blade Width	Blade Style	Weight (Lbs)	Pkg. Type
60150	3 Pc Ladyfoot Pry Bar Set 40150 – 1/2 X 12" Ladyfoot Pry Bar 40152 – 5/8 X 16" Ladyfoot Pry Bar 40154 – 3/4 X 21" Ladyfoot Pry Bar	0 45256 60150 2	N/A	N/A	Round	N/A	N/A	3.75	Tray
61306	3 Pc Line-Up Pry Bar Set 40000 – Reg 14" Line-Up Pry Bar 40002 – Reg 20" Line-Up Pry Bar 40101 – Reg 16" Rolling Head Pry Bar	0 45256 61306 2	N/A	N/A	Hex	N/A	N/A	4.25	Tray
61350	3 Pc Screwdriver Pry Bar Set 40110 – 7-C Reg 12" OAL Curved Screwdriver Pry Bar 40111 – 12-C Reg 17" OAL Curved Screwdriver Pry Bar 40112 – 18-C Reg 25" OAL Curved Screwdriver Pry Bar	0 45256 61350 5	N/A	N/A	Square	N/A	Curved	3.65	Tray
61352	2 Pc Screwdriver Pry Bar Set 40109 – 24-C Reg 31" OAL Curved Screwdriver Pry Bar 40112 – 18-C Reg 25" OAL Curved Screwdriver Pry Bar	0 45256 61352 9	N/A	N/A	Square	N/A	Curved	4.65	Tray
76295	4 Pc Utility Pry Bar Set 40001 – Reg 16" Line-Up Pry Bar 40152 – 5/8 X 16" Ladyfoot Pry Bar 60144 – 12-C Dominator 98602 – Mini Utility Bar	0 45256 76295 1	20-1/4	N/A	N/A	N/A	N/A	4.03	Tray
80026	#16 Singles Display, Pry Bars 60000 – 4 Pc Dominator HD Hook & Pick Set 60001 – 4 Pc Dominator HD Carbon Scraper 60137 – 5-C Dominator 60140 – 7-C Dominator 60144 – 12-C Dominator 60146 – 18-C Dominator 60148 – 24-C Dominator 60150 – 3 Pc Ladyfoot Pry Bar Set 61353 – 2 Pc Dominator Screwdriver Pry Bar Set 61355 – 3 Pc Dominator Curved Screwdriver Pry Bar Set 76284 – 4 Pc Ec Pry Bar Set	0 45256 80026 4	N/A	N/A	Square	N/A	N/A	97.06	Wire Rack



Deck Wrecker

- Mayhew's specialty demolition tool, the Deck Wrecker, is used to rip up boards of any decking material used in the construction of decks and other similar structures
- The double prying head fits over a double or single joist for maximum leverage
- Available in a powder-coated finish
- Made in the USA

Item	Description	UPC Code	OAL	Body Size	Body Type	Blade Width	Blade Style	Weight (Lbs)	Pkg. Type
41104	Deck Wrecker	0 45256 41104 0	45-1/2	0	Round	0	N/A	8.70	Bulk
41105	Deck Wrecker w/Indexing Head	0 45256 41105 0	33-1/2	1"	Round	0	N/A	8.70	Bulk

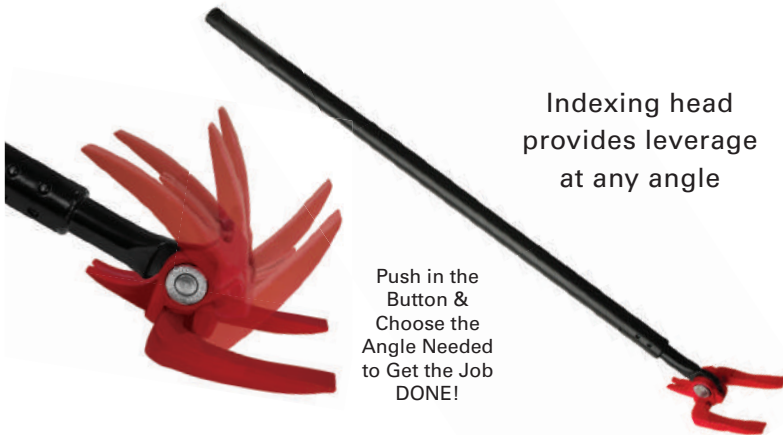

Indexing head provides leverage at any angle

Push in the Button & Choose the Angle Needed to Get the Job DONE!

- Easy to adjust indexing feature works with the touch of a button
- Adjusting the head angle provides the most leverage and comfortable working position
- Designed for removing decking and general deconstruction
- Made from forged alloy steel
- Reverse the indexing head to remove nails with the nail puller.



Mayhew Steel Products, Inc.
199 Industrial Blvd.
Turners Falls, MA 01376

U.S. Toll-Free Customer Service: 800-872-0037
Visit us online at www.Mayhew.com
Always wear safety goggles when using hand tools.

Version 2.2016
For the latest version, visit us online at www.Mayhew.com

The Pros Know

Dominator

Pry Bars

Scrapers

Chisels

Punches

Steel Sets/
Kits

Specialty &
Extractors

Retail
Displays

Brass Sets/
Kits

150

Hard Cap

Hollow Punch
Sets

Automotive/
Specialty

Pneumatic

11



Screwdriver-Style Pry Bars

- Used for prying and lifting
- Available in both a curved and straight blade style
- Variable lengths available for work in hard-to-reach locations
- Durable acetate handle provides a more comfortable and secure grip
- Black oxide finish for additional rust protection
- Made in the USA

Item	Description	UPC Code	OAL	Body Size	Body Type	Blade Width	Blade Style	Weight (Lbs)	Pkg. Type
35724	Screwdriver 5/16" X 28"	0 45256 35724 9	28	1/4	Square	5/16	N/A	2.19	Bulk
40106	17" Straight Screwdriver Pry Bar	0 45256 40106 5	17	3/8	Square	0	Straight	5.38	Bulk
40108	25" Straight Screwdriver Pry Bar	0 45256 40108 9	25	1/2	Square	0	Straight	1.50	Bulk
40109	31" OAL Curved Screwdriver Pry Bar	0 45256 40109 6	31	1/2	Square	0	Curved	2.00	Bulk
40110	12" OAL Curved Screwdriver Pry Bar	0 45256 40110 2	12	3/8	Square	0	Curved	0.33	Bulk
40111	17" OAL Curved Screwdriver Pry Bar	0 45256 40111 9	17	3/8	Square	0	Curved	0.53	Bulk
40112	25" OAL Curved Screwdriver Pry Bar	0 45256 40112 6	25	1/2	Square	0	Curved	1.50	Bulk
40113	24S Reg 31" Straight Screwdriver Pry Bar	0 45256 40113 3	31	1/2	Square	0	Straight	2.00	Bulk



Scrapers

- Used for a multitude of applications, such as removing gaskets, rust, paint, carbon buildup, and floor tile
- Blades are ground for a sharp edge and can be resharpened after heavy use to return the cutting edge to sharpness
- Available in straight and curved blades
- Black oxide finish for additional rust protection
- Made in the USA

Item	Description	UPC Code	OAL	Body Size	Body Type	Blade Width	Blade Style	Weight (Lbs)	Pkg. Type
37039	Carbon Scraper	0 45256 37039 2	9-3/4	1/4	Square	1	N/A	1.08	Bulk
37040	Carbon Scraper	0 45256 37040 8	13	3/8	Square	1-1/2	N/A	2.10	Bulk
37241	Offset Scraper	0 45256 37241 9	6-1/4	1/4	Square	5/8	N/A	1.03	Bulk
37243	5/8" Scraper	0 45256 37243 3	5-1/4	1/4	Square	5/8	N/A	0.74	Bulk
37245	Stubby Scraper	0 45256 37245 7	7	1/4	Square	1	N/A	0.71	Bulk

Scraper Set

Item	Description	UPC Code	OAL	Body Size	Body Type	Blade Width	Blade Style	Weight (Lbs)	Pkg. Type
37365	4 Pc Scraper Set 37039 – Carbon Scraper 37241 – Offset Scraper 37243 – 5/8" Scraper 37245 – Stubby Scraper	0 45256 37365 2	N/A	N/A	N/A	N/A	N/A	1.05	Clamshell



Cold Chisels

- Used to cut and shape metals softer than the cutting edge of the chisel
- Cutting-edge angle designed to provide greater strength
- Not intended to be used on masonry materials
- Available in a variety of lengths and sizes to fit any application
- Available in black oxide finish for additional rust protection
- Made in the USA

Item	Description	UPC Code	OAL	Body Size	Body Type	Blade Width	Blade Style	Weight (Lbs)	Pkg. Type
10200	COLD CHISEL 1/4-6MM X 5	045256102009	5	0.25	hex	1/4-6mm	N/A	0.0772	Bulk
10237	COLD CHISEL 9/32-7mm X 5	045256102375	5	0.25	hex	9/32-7mm	N/A	0.0772	Bulk
10201	COLD CHISEL 5/16-8mm X 5	045256102016	5	0.25	hex	5/16-8mm	N/A	0.0772	Bulk
10202MAY	COLD CHISEL 3/8-10mm X 5-1/2	045256102023	5-1/2	0.312	hex	3/8-10mm	N/A	0.1204	Bulk
10204	COLD CHISEL 7/16-11mm X 6	045256102047	6	0.375	hex	7/16-11mm	N/A	0.208	Bulk
10205	COLD CHISEL 1/2-13mm X 6	045256102054	6	0.437	hex	1/2-13mm	N/A	0.26	Bulk
10209	COLD CHISEL 5/8-16mm X 6-1/2	045256102092	6-1/2	0.5	hex	5/8-16mm	N/A	0.4004	Bulk
10212	COLD CHISEL 3/4-19mm X 7	045256102122	7	0.625	hex	3/4-19mm	N/A	0.6737	Bulk
10216	COLD CHISEL 7/8-22mm X 7-1/2	045256102160	7-1/2	0.75	hex	7/8-22mm	N/A	1.0394	Bulk
10220	COLD CHISEL 1-25mm X 8	045256102207	8	0.875	hex	1-25mm	N/A	1.5085	Bulk
Long Chisels									
10206	COLD CHISEL 1/2-13mm X 9	045256102061	9	0.437	hex	1/2-13mm	N/A	0.39	Bulk
10207	COLD CHISEL 1/2-13mm X 12	045256102078	12	0.437	hex	1/2-13mm	N/A	0.5636	Bulk
10210	COLD CHISEL 5/8-16mm X 12	045256102108	12	0.5	hex	5/8-16mm	N/A	0.7376	Bulk
10213	COLD CHISEL 3/4-19mm X 12	045256102139	12	0.625	hex	3/4-19mm	N/A	1.1528	Bulk
10217	COLD CHISEL 7/8-22mm X 12	045256102177	12	0.75	hex	7/8-22mm	N/A	1.66	Bulk
10221	COLD CHISEL 1-25mm X 12	045256102214	12	0.75	hex	1-25mm	N/A	1.6605	Bulk
Extra Long chisels									
10215	COLD CHISEL 3/4-19mm X 18	045256102153	18	0.625	hex	3/4-19mm	N/A	1.7278	Bulk
10219	COLD CHISEL 7/8-22mm X 18	045256102191	18	0.75	hex	7/8-22mm	N/A	2.4887	Bulk
10222	COLD CHISEL 1-25mm X 18	045256102221	18	0.75	hex	1-25mm	N/A	2.4887	Bulk



Cape Chisels

- Also known as a slot chisel
- Used to cut flat grooves for keyways or slots
- Narrows to a flat cutting end for precision
- Available in varying cuts and lengths, for varying sizes of grooves
- Black oxide finish for additional rust prevention
- Made in the USA

Item	Description	UPC Code	OAL	Body Size	Body Type	Blade Width	Blade Style	Weight (Lbs)	Pkg. Type
10400	1/8" Reg Cape Chisel	0 45256 10400 3	5-1/2	5/16	Hex	1/8	N/A	0.10	Bulk
10401	3/16" Reg Cape Chisel	0 45256 10401 0	5-5/8	3/8	Hex	3/16	N/A	0.15	Bulk
10402MAY	1/4" Reg Cape Chisel	0 45256 10402 7	5-5/8	3/8	Hex	1/4	N/A	0.12	Bulk
10403	5/16" Reg Cape Chisel	0 45256 10403 4	6-1/4	1/2	Hex	5/16	N/A	0.30	Bulk
10404	3/8" Reg Cape Chisel	0 45256 10404 1	7	5/8	Hex	3/8	N/A	0.50	Bulk
10405	1/2" Reg Cape Chisel	0 45256 10405 8	8	3/4	Hex	1/2	N/A	0.85	Bulk



Half Round Nose Chisels

- Also known as gouge chisels
- Used for cutting round grooves in metal
- Many specialized uses such as cutting semicircular grooves for oilways in bearings
- Available in varying cuts for the perfect groove
- Black oxide finish for additional rust protection
- Made in the USA

Item	Description	UPC Code	OAL	Body Size	Body Type	Blade Width	Blade Style	Weight (Lbs)	Pkg. Type
10500	1/8" Half Round Nose Chisel	0 45256 10500 0	5-1/2	5/16	Hex	1/8	N/A	0.10	Bulk
10501	3/16" Half Round Nose Chisel	0 45256 10501 7	5-1/2	3/8	Hex	3/16	N/A	0.15	Bulk
10502MAY	1/4" Half Round Nose Chisel	0 45256 10502 4	5-3/4	3/8	Hex	1/4	N/A	0.32	Bulk
10503	5/16" Half Round Nose Chisel	0 45256 10503 1	6-1/4	1/2	Hex	5/16	N/A	0.32	Bulk
10504	3/8" Half Round Nose Chisel	0 45256 10504 8	7	5/8	Hex	3/8	N/A	0.53	Bulk
10505	1/2" Half Round Nose Chisel	0 45256 10505 5	8	3/4	Hex	1/2	N/A	0.86	Bulk



Mayhew Steel Products, Inc.
199 Industrial Blvd.
Turners Falls, MA 01376

U.S. Toll-Free Customer Service: 800-872-0037
Visit us online at www.Mayhew.com
Always wear safety goggles when using hand tools.

Version 2.2016
For the latest version, visit us
online at www.Mayhew.com

The Pros Know

Dominator

Pry Bars

Scrapers

Chisels

Punches

Steel Sets/
Kits

Specialty &
Extractors

Retail
Displays

Brass Sets/
Kits

150

Hard Cap

Hollow Punch
Sets

Automotive/
Specialty

Pneumatic

13



Diamond Point Chisels

- Used to make a v-shaped groove in metal, provides a sharp pointed bottom to the grooves
- Available in varying cuts and lengths, for varying sizes of grooves
- Black oxide finish for additional rust protection
- Made in the USA

Item	Description	UPC Code	OAL	Body Size	Body Type	Blade Width	Blade Style	Weight (Lbs)	Pkg. Type
10600	1/8" Reg Diamond Point Chisel	0 45256 10600 3	5	5/16	Hex	1/8	N/A	0.10	Bulk
10601	3/16" Reg Diamond Point Chisel	0 45256 10601 0	5-1/2	3/8	Hex	3/16	N/A	0.12	Bulk
10602MAY	1/4" Reg Diamond Point Chisel	0 45256 10602 7	5-3/4	3/8	Hex	1/4	N/A	0.17	Bulk
10603	5/16" Reg Diamond Point Chisel	0 45256 10603 8	6	1/2	Hex	5/16	N/A	0.31	Bulk
10604	3/8" Reg Diamond Point Chisel	0 45256 10604 5	7	5/8	Hex	3/8	N/A	0.55	Bulk
10605MAY	1/2" Reg Diamond Point Chisel	0 45256 10605 2	7	3/4	Hex	1/2	N/A	0.78	Bulk



Bearing Race Punches

- Used to remove bearing races in automotive and industrial settings
- Larger tips are designed for larger bearing sizes
- Specially heat-treated steel makes these tools ideal for stubborn bearing races
- Black oxide finish for additional rust protection
- Made in the USA

Item	Description	UPC Code	OAL	Body Size	Body Type	Blade Width	Blade Style	Weight (Lbs)	Pkg. Type
24548	7/16" Bearing Race Punch	0 45256 24548 5	6	3/8	Hex	7/16	N/A	0.20	Bulk
24549	1/2" Bearing Race Punch	0 45256 24549 2	10	7/16	Hex	1/2	N/A	0.50	Bulk
24550	5/8" Bearing Race Punch	0 45256 24550 8	20	9/16	Hex	5/8	N/A	1.51	Bulk
24551	9/16" Bearing Race Punch	0 45256 24551 5	14	1/2	Hex	9/16	N/A	0.83	Bulk



Center Punches

- Used for piercing, or marking for starting drills, in metal and other materials
- Point sizes vary for larger or smaller holes
- If you want to scribe lines in metal, consider a prick punch
- Available in black oxide finish for additional rust protection
- Made in the USA

Item	Description	UPC Code	OAL	Body Size	Body Type	Point Size	Blade Style	Weight (Lbs)	Pkg. Type
24005	CENTER PUNCH 1/16-1.5mm x 4	045256240053	4	0.25	hex	1/16-1.5mm	N/A	0.05	Bulk
24006	CENTER PUNCH 5/64-2mm x 4	045256240060	4	0.25	hex	5/64-2mm	N/A	0.05	Bulk
24000	CENTER PUNCH 3/32-2.5mm x 4	045256240008	4	0.25	hex	3/32-2.5mm	N/A	0.04	Bulk
24007	CENTER PUNCH 1/8-3mm x 4-1/4	045256240077	4-1/4	0.312	hex	1/8-3mm	N/A	0.09	Bulk
24001	CENTER PUNCH 5/32-4mm x 4-1/2	045256240015	4-1/2	0.312	hex	5/32-4mm	N/A	0.09	Bulk
24002	CENTER PUNCH 3/16-5mm x 5	045256240022	5	0.375	hex	3/16-5mm	N/A	0.15	Bulk
24008	CENTER PUNCH 1/4-6mm x 5-1/2	045256240084	5-1/2	0.437	hex	1/4-6mm	N/A	0.23	Bulk
24003	CENTER PUNCH 5/16-8mm x 6	045256240039	6	0.5	hex	5/16-8mm	N/A	0.34	Bulk
24004	CENTER PUNCH 3/8-10mm x 6-1/4	045256240046	6-1/4	0.625	hex	3/8-10mm	N/A	0.5	Bulk



Prick Punches

- Used to scribe lines in metal before cutting or riveting
- Variable point sizes for different width marks
- Sharper angle specifically designed to scribe lines in metal
- Available in black oxide finish for additional rust protection
- Made in the USA

Item	Description	UPC Code	OAL	Body Size	Body Type	Point Size	Blade Style	Weight (Lbs)	Pkg. Type
23000	PRICK PUNCH 3/32-2.5mm x 4	045256230009	4	0.25	hex	3/32-2.5mm	N/A	0.04	Bulk
23001	PRICK PUNCH 3/16-5mm x 4-1/2	045256230016	4-1/2	0.312	hex	3/16-5mm	N/A	0.09	Bulk
23002	PRICK PUNCH 5/32-4mm x 5	045256230023	5	0.375	hex	5/32-4mm	N/A	0.15	Bulk
23003	PRICK PUNCH 1/8-3mm x 6	045256230030	6	0.5	hex	1/8-3mm	N/A	0.28	Bulk

Dominator
 Pry Bars
 Scrapers
 Chisels
 Punches
 Steel Sets/
 Kits
 Specialty &
 Extractors
 Retail
 Displays
 Brass Sets/
 Kits
 150
 Hard Cap
 Hallow Punch
 Sets
 Automotive/
 Specialty
 Pneumatic
 14



Line-Up Punches or Drift Punches

- Used to align holes through which rivets, pins, or bolts will be inserted
- Not for use when driving pins, rivets, or bolts
- Variable point size, shank size, and taper length for the perfect alignment
- Available in black oxide finish for additional rust protection
- Made in the USA

Item	Description	UPC Code	OAL	Body Size	Body Type	Point Size	Taper Length	Weight (Lbs)	Pkg. Type
Regular Line-Up or Drift Punch									
22021	LINE-UP PUNCH 3/32 X 8	045256220215	8	0.312	hex	3/32	3-1/2	0.13	Bulk
22010	LINE-UP PUNCH 1/8-3mm X 8	045256220109	8	0.312	hex	1/8 - 3mm	3-1/2	0.15	Bulk
22011	LINE-UP PUNCH 5/32-4mm X 9	045256220116	9	0.375	hex	5/32 - 4mm	4-1/2	0.23	Bulk
22000	LINE-UP PUNCH 5/32 X 8	045256220000	8	0.5	hex	5/32 - 4mm	4-1/2	0.35	Bulk
22012	LINE-UP PUNCH 3/16 X 10	045256220123	10	0.5	hex	3/16	5	0.44	Bulk
22025	LINE-UP PUNCH 7/32 X 10	045256220253	10	0.5	hex	7/32	5	0.45	Bulk
22003	LINE-UP PUNCH 1/4 X 12	045256220031	12	0.625	hex	1/4	6-3/4	0.82	Bulk
22005	LINE-UP PUNCH 1/4 X 15	045256220055	15	0.75	hex	1/4	7-1/4	1.867	Bulk
22009	LINE-UP PUNCH 1/4 X 18	045256220093	18	0.625	hex	1/4	7-1/4	1.41	Bulk
22013	LINE-UP PUNCH 5/16-8mm X 12	045256220130	12	0.625	hex	5/16 - 8mm	7	0.85	Bulk
22017	LINE-UP PUNCH 3/8 X 15	045256220178	15	0.75	hex	3/8	7-1/4	1.9708	Bulk
22024	LINE-UP PUNCH 1/2 X 18	045256220246	18	0.875	hex	1/2	7-1/2	2.87	Bulk
Extra Long aligning punches									
22006	LINE-UP PUNCH 3/16 X 12	045256220062	12	0.75	hex	3/16	6	0.33	Bulk
22007	LINE-UP PUNCH 1/4 X 14	045256220079	14	0.5	hex	1/4	7	0.64	Bulk
22008	LINE-UP PUNCH 5/16 X 16	045256220086	16	0.625	hex	5/16	7-1/4	1.16	Bulk



Pilot® or Roll Pin Punches

- Original Mayhew patented design with a rounded end that fits snugly within a roll pin
- Also known as a roll pin punch
- Used to drive in and remove roll pins or other hollow tension pins
- Variable point sizes available for variable radius sizes for all pin configurations
- Available in fractional or metric sizes
- Made in the USA

Item	Description	UPC Code	OAL	Body Size	Body Type	Point Size	Pin Length	Weight (Lbs)	Pkg. Type
25000	PILOT PUNCH 1/16 x 2-3/4	045256250007	2-3/4	1/4	Round	1/16	1	0.0108	Bulk
25001	PILOT PUNCH 5/64 X 3-1/4	045256250014	3-1/4	1/4	Round	5/64	1.5	0.0116	Bulk
25002	PILOT PUNCH 3/32 X 3-1/2	045256250021	3-1/2	1/4	Round	3/32	1.5	0.0125	Bulk
25003	PILOT PUNCH 1/8 X 4	045256250038	4	1/4	Round	1/8	2	0.0138	Bulk
25004	PILOT PUNCH 5/32 X 4-1/2	045256250045	4-1/2	1/4	Round	5/32	2.5	0.0244	Bulk
25005	PILOT PUNCH 3/16 X 4-1/2	045256250052	4-1/2	3/8	Round	3/16	2.5	0.0261	Bulk
25006	PILOT PUNCH 7/32 X 5	045256250069	5	3/8	Round	7/32	3	0.0386	Bulk
25007	PILOT PUNCH 1/4 X 5-1/2	045256250076	5-1/2	7/16	Round	1/4	3.5	0.0417	Bulk
25008	PILOT PUNCH 5/16 X 6	045256250083	6	7/16	Round	5/16	4	0.061	Bulk
25009	PILOT PUNCH 3/8 X 6	045256250090	6	1/2	Round	3/8	4	0.0868	Bulk
25010	PILOT PUNCH 7/16 X 6	045256250106	6	5/8	Round	7/16	4	0.1395	Bulk
25011	PILOT PUNCH 1/2 X 6	045256250113	6	5/8	Round	1/2	4	0.1605	Bulk
Metric Pilot Punches									
25014	PUNCH PILOT 1.5mm X 2-3/4	045256250144	2-3/4	1/4	Round	1.5mm	1.5	0.0108	Bulk
25015	PILOT PUNCH 2mm X 3-1/4	045256250151	3-1/4	1/4	Round	2mm	1.5	0.0116	Bulk
25016	PILOT PUNCH 2.5mm X 3-1/2	045256250168	3-1/2	1/4	Round	2.5mm	1.5	0.013	Bulk
25017	PILOT PUNCH 3mm X 4	045256250175	4	1/4	Round	3mm	2	0.0135	Bulk
25018	PUNCH PILOT 3.5mm X 4	045256250182	4	1/4	Round	3.5mm	2	0.0227	Bulk
25019	PILOT PUNCH 4mm X 4-1/2	045256250199	4-1/2	3/8	Round	4mm	2.5	0.0244	Bulk
25021	PILOT PUNCH 5mm X 4-1/2	045256250212	4-1/2	3/8	Round	5mm	2.625	0.0269	Bulk
25023	PILOT PUNCH 6mm X 5-1/2	045256250236	5-1/2	7/16	Round	6mm	3.5	0.0403	Bulk
25029	PILOT PUNCH 8mm X 6	045256250298	6	1/2	Round	8mm	4	0.061	Bulk
25026	PUNCH PILOT 10mm X 6	045256250267	6	5/8	Round	10mm	4	0.0927	Bulk
25028	PUNCH PILOT 12mm X 6	045256250281	6	5/8	Round	12mm	4	0.1511	Bulk



Mayhew Steel Products, Inc.
199 Industrial Blvd.
Turners Falls, MA 01376

U.S. Toll-Free Customer Service: 800-872-0037
Visit us online at www.Mayhew.com
Always wear safety goggles when using hand tools.

Version 2.2016
For the latest version, visit us
online at www.Mayhew.com

The Pros Know

Dominator

Pry Bars

Scrapers

Chisels

Punches

Steel Sets/
Kits

Specialty &
Extractors

Retail
Displays

Brass Sets/
Kits

150

Hard Cap

Hollow Punch
Sets

Automotive/
Specialty

Pneumatic

15



- Used to drive out and remove already loosened pins and keys after initial movement by a solid punch
- Variable point sizes and lengths for different applications
- Not for use on seized pins and keys; loosen with a solid punch first
- Available in fractional and metric sizes
- Available in black oxide finish for additional rust protection
- Made in the USA

Pin Punches

Item	Description	UPC Code	OAL	Body Size	Body Type	Point Size	Pin Length	Weight (Lbs)	Pkg. Type
REGULAR PIN LENGTH									
21000	PIN PUNCH 1/16X 4"	045256210001	4	0.25	hex	1/16	3/4	0.0509	Bulk
21010	PIN PUNCH 5/64X 4-1/4"	045256210100	4-1/4	0.25	hex	5/64	13/16	0.052	Bulk
21001	PIN PUNCH 3/32X 4-1/2"	045256210018	4-1/2	0.25	hex	3/32	7/8	0.0531	Bulk
21002	PIN PUNCH 1/8X 4-3/4"	045256210025	4-3/4	0.312	hex	1/8	1	0.0618	Bulk
21003	PIN PUNCH 5/32X 5"	045256210032	5	0.312	hex	5/32	1	0.1052	Bulk
21004	PIN PUNCH 3/16X 5-1/4"	045256210049	5-1/4	0.312	hex	3/16	1-1/4	0.1171	Bulk
21011	PIN PUNCH 7/32X 5-1/2"	045256210117	5-1/2	0.375	hex	7/32	1-1/4	0.1231	Bulk
21005	PIN PUNCH 1/4X 5-3/4"	045256210056	5-3/4	0.375	hex	1/4	1-1/4	0.1864	Bulk
21019	PIN PUNCH 5/16X 6"	045256210193	6	0.437	hex	5/16	1-1/4	0.208	Bulk
21014	PIN PUNCH 3/8 X 7-1/8"	045256210148	7-1/8	0.5	hex	3/8	2	0.3549	Bulk
21016	PIN PUNCH 7/16 X 8"	045256210162	8	0.625	hex	7/16	2-1/2	0.3623	Bulk
21017	PIN PUNCH 1/2 X 8"	045256210179	8	0.625	hex	1/2	2-1/2	0.5778	Bulk
Extra Long Pin length									
21500	PIN PUNCH 1/8 X 8"	045256215006	8	0.312	hex	1/8	3	0.12	Bulk
21506	PIN PUNCH 5/32 X 8"	045256215068	8	0.312	hex	5/32	3	0.12	Bulk
21501	PIN PUNCH 3/16 X 8"	045256215013	8	0.375	hex	3/16	3-1/2	0.16	Bulk
21505	PIN PUNCH P 7/32 x 8	045256215051	8	0.375	hex	7/32	3-1/2	0.16	Bulk
21502	PIN PUNCH 1/4 X 8"	045256215020	8	0.375	hex	1/4	3-1/2	0.19	Bulk
21503	PIN PUNCH 5/16 X 8"	045256215037	8	0.437	hex	5/16	3-1/2	0.28	Bulk
21504	PIN PUNCH 3/8 X 8"	045256215044	8	0.5	hex	3/8	3-1/2	0.38	Bulk
METRIC PIN PUNCHES									
Metric regular pin length									
21240	PIN PUNCH 1.5mm X 4"	045256212401	4	0.25	hex	1.5mm	3/4	0.0509	Bulk
21241	PIN PUNCH 2mm X 4-1/4"	045256212418	4-1/4	0.25	hex	2mm	3/4	0.052	Bulk
21242	PIN PUNCH 2.5mm X 4-1/2"	045256212425	4-1/2	0.25	hex	2.5mm	1	0.0531	Bulk
21243	PINPUNCH 3mm X 4-5/8"	045256212432	4-5/8	0.312	hex	3mm	1	0.0618	Bulk
21244	PIN PUNCH 4mm	045256212449	5	0.312	hex	4mm	1	0.1052	Bulk
21245	PIN PUNCH 5mm X 5-3/8	045256212456	5-3/8	0.312	hex	5mm	1-1/4	0.1171	Bulk
21246	PIN PUNCH 6mm X 5-5/8	045256212463	5-5/8	0.375	hex	6mm	1-1/4	0.1864	Bulk
21247	PIN PUNCH 8mm X 6	045256212470	6	0.437	hex	8mm	1-1/4	0.208	Bulk
21248	PIN PUNCH 10mm x 7 1/8	45256212487	7-1/8	0.5	hex	10mm	2	0.3549	Bulk
Metric extra long pin length									
21249	PIN PUNCH 12mm x8	045256212494	8	0.625	hex	12mm	3-1/2	0.3623	Bulk
21508	PIN PUNCH 3mm x8	045256215082	8	0.312	hex	3mm	3	0.1	Bulk
21510	PIN PUNCH 4mm x8	045256215105	8	0.312	hex	4mm	3	0.13	Bulk
21512	PIN PUNCH 5mm X 8	045256215129	8	0.375	hex	5mm	3-1/2	0.17	Bulk
21514	PIN PUNCH 6mm X 8	045256215143	8	0.375	hex	6mm	3-1/2	0.19	Bulk
21516	PIN PUNCH 7mm X 8	045256215167	8	0.375	hex	7mm	3-1/2	0.2	Bulk
21518	PIN PUNCH 8mm X 8	045256215181	8	0.437	hex	8mm	3-1/2	0.27	Bulk
21519	PIN PUNCH 9mm X 8	045256215198	8	0.5	hex	9mm	3-1/2	0.36	Bulk
21520	PIN PUNCH 10mm x8	045256215204	8	0.5	hex	10mm	3-1/2	0.39	Bulk

Dominator
 Pry Bars
 Scrapers
 Chisels
Punches
 Steel Sets/
 Kits
 Specialty &
 Extractors
 Retail
 Displays
 Brass Sets/
 Kits
 150
 Hard Cap
 Hallow Punch
 Sets
 Automotive/
 Specialty
 Pneumatic
 16



Solid or Starter Punches

- For loosening frozen or tight pins and keys, or knocking out rivets
- Variable point sizes for different sized pins and keys
- Once loosened, follow up with a pin punch to drive the pin or key out
- Available in black oxide finish for additional rust protection
- Made in the USA

Item	Description	UPC Code	OAL	Body Size	Body Type	Point Size	Taper Length	Weight (Lbs)	Pkg. Type
20004	SOLID PUNCH 1/16-1.5mm X 5	045256200040	5	0.375	hex	1/16-1.5mm	1-1/2	0.15	Bulk
20000	SOLID PUNCH 3/32-2.5mm X 5	045256200002	5	0.375	hex	3/32-2.5mm	1-1/2	0.15	Bulk
20020	SOLID PUNCH 3mm X 5	045256200200	5	0.375	hex	3mm	1-1/2	0.15	Bulk
20001	SOLID PUNCH 1/8 X 5	045256200019	5	0.375	hex	1/8	1-1/2	0.15	Bulk
20005	SOLID PUNCH 5/32-4mm X 5	045256200057	5	0.375	hex	5/32-4mm	1-1/2	0.15	Bulk
20002	SOLID PUNCH 3/16 X 5	045256200026	5	0.375	hex	3/16	1-1/2	0.15	Bulk
20026	SOLID PUNCH 6mm X 5	045256200262	5	0.375	hex	6mm	1-1/2	0.15	Bulk
20003	SOLID PUNCH 1/4 X 5	045256200033	5	0.375	hex	1/4	1-1/2	0.15	Bulk
20105	SOLID PUNCH 5/16-8mm X 6	045256201054	6	0.5	hex	5/16-8mm	2	0.33	Bulk
20301	SOLID PUNCH 3/8 X 6-1/2	045256203010	6-1/2	0.5	hex	3/8	2-1/4	0.54	Bulk



Rivet Set

- Used for mushrooming and setting rivet heads
- Made in the USA

Item	Description	UPC Code	OAL	Body Size	Body Type	Blade Width	Blade Style	Weight (Lbs)	Pkg. Type
20900	Reg Rivet Set	0 45256 20900 5	5	5/8	Hex	3/8	N/A	0.42	Bulk



Rivet Buster

- Used for cutting the heads off rivets for easy removal
- Made in the USA

Item	Description	UPC Code	OAL	Body Size	Body Type	Blade Width	Blade Style	Weight (Lbs)	Pkg. Type
11300	Reg Rivet Buster	0 45256 11300 5	5	3/4	Hex	3/4	N/A	0.51	Bulk

Steel Punch and Chisel Sets

Item	Description	UPC Code	Item Length	Item Height	Item Width	Item Weight	COO
60560	6 pc Cold Chisel Set	045256605609	8.00	0.75	2.50	1.56	US
61510	10 PC COLD CHISEL	045256615103	9.25	3.25	2.225	4.16	US
61512	5 PC LONG COLD CHISEL	045256615127	14.00	3.00	3.00	3.75	US
61518	3 PC XL COLD CHISEL	045256615189	24.00	2.00	2.00	2.85	US
62078	12 PC PIN PUNCH (INCH)	045256620787	9	3.75	2.5	3	US
60007	7 PC CENTER PUNCH	045256600079	6.75	2	2	1.11	US
62212	12 PC CENTER & PRICK	045256622125	9.25	3.5	1.75	2.15	US
61810	4 PC ALIGNING PUNCH KIT	045256618104	21	2.5	2.25	7.775	US
66251	6 PC PIN PUNCH (MM)	045256662510	9	2.75	1.5	1.29	US
62078	12 PC PIN PUNCH (INCH)	045256620787	9	3.75	2.5	3	US
66257	9 PC PUNCH & CHISEL (MM)	45256662572	7	2.75	1.25	0.88	US
62081	6 PC LONG PIN PUNCH (MM)	045256620817	9	2.5	1.5	1.445	US
61406	6 PC PUNCH & CHISEL (INCH)	045256614069	9	2.75	1.5	1.125	US
61409	9 PC PUNCH & CHISEL (INCH)	045256614090	7.25	3	1.25	0.89	US
66256	6 PC PUNCH AND CHISEL SET (MM)	045256622569	9	2.75	1.5	1.19	US
66258	12 PC PUNCH & CHISEL (MM)	045256622583	7.25	4.38	2.63	2.41	US
62207	7 PC CENTER & PRICK	045256622071	9.00	4.50	2.50	3.50	US
66252	9 PC PIN PUNCH (MM)	045256662527	7.00	3.50	1.50	1.95	US
66253	11 PC PIN PUNCH (MM)	045256662534	9.00	4.00	2.00	2.56	US
61411	11 PC PUNCH & CHISEL (INCH)	045256614113	6	4.5	1	1.21	US
66287	20 PC PUNCH & CHISEL (MM)	045256662879	11.00	6.50	4.50	4.25	US
61005	6 PC PUNCH AND CHISEL SET (INCH)	45256610054	8.50	1.00	3.00	1.25	US
61406	6 PC PUNCH AND CHISEL SET (INCH)	045256614069	9.00	1.50	2.78	1.13	US
61409	9 PC PUNCH AND CHISEL (INCH)	045256614090	7.25	1.25	3.00	0.89	US
61412	12 PUNCH AND CHISEL (INCH)	045256614120	9.00	2.00	3.50	2.81	US
61044	14 PC PUNCH AND CHISEL SET (INCH)	45256610443	8.50	2.25	3.25	2.85	US
61019	19 PC PUNCH AND CHISEL SET (INCH)	45256610191	8.00	2.50	5.00	3.82	US
61050	24 PC PUNCH AND CHISEL (INCH)	45256610504	8.50	2.00	4.00	4.56	US
62256	6 PC PUNCH AND CHISEL (MM)	045256622569	9.00	1.50	2.75	1.19	US
66287	20 PC PUNCH AND CHISEL (MM)	045256662879	11.00	6.50	4.50	4.25	US
62250	6 PC ROLL PIN OR PILOT PUNCH (INCH)	45256622507	7.50	0.75	2.00	0.60	US
62253	6 PC ROLL PIN OR PILOT PUNCH (INCH)	045256622538	7.50	1.00	4.50	0.60	US
62255	6 PC ROLL PIN OR PILOT PUNCH (INCH)	045256622552	11.00	1.00	4.00	0.65	US
62252	9 PC ROLL PIN OR PILOT PUNCH (INCH)	45256622521	7.50	1.00	2.25	0.66	US
62254	12 PC ROLL PIN OR PILOT PUNCH (INCH)	45256622545	7.50	1.00	4.50	1.61	US
62258	12 PC ROLL PIN OR PILOT PUNCH (INCH)	45256622583	7.50	2.63	4.38	2.41	US
66265	6 PC ROLL PIN OR PILOT PUNCH (MM)	045256662657	7.50	1.00	2.50	0.50	US
66264	5 PC ROLL PIN OR PILOT PUNCH (MM)	045256662640	11.00	1.00	4.00	0.50	US
66261	6 PC ROLL PIN OR PILOT PUNCH (MM)	045256662619	9.25	1.00	3.00	0.64	US
66262	9 PC ROLL PIN OR PILOT PUNCH (MM)	045256662626	7.50	0.75	3.50	0.55	US
66263	11 PC ROLL PIN OR PILOT PUNCH (MM)	045256662633	7.50	1.00	3.50	0.90	US
62076	6 PC PIN PUNCH (INCH)	045256620763	7.50	0.50	2.00	1.05	US
62074	6 PC PIN PUNCH (INCH)	045256620749	11.00	0.75	4.00	1.85	US
62065	5 PC LONG PIN PUNCH (INCH)	045256620657	9.50	1.00	2.25	1.23	US
61811	6 PC ALIGNING PUNCH	045256618111	13.50	0.75	4.00	3.32	US
62235	4 PC ALIGNING PUNCH KIT	045256622354	13.00	1.25	1.75	1.78	US
61505	5 PC COLD CHISEL	045256615059	9.50	2.00	2.00	1.89	US
61506	5 PC COLD CHISEL	045256615066	10.50	1.50	4.50	2.28	US
62214	5 PC CENTER PUNCH'	045256622149	7.25	1.50	2.50	1.15	US
62215	4 PC CENTER PUNCH	045256622156	11.00	0.50	4.00	0.75	US
61340	6 PC SOLID OR STARTING PUNCH	045256613406	7.25	1.50	2.00	1.16	US
62077	10 PC PUNCH MIX	045256620770	9.00	1.00	4.00	1.76	US
61341	16 PC PUNCH MIX	045256613413	7.50	1.75	3.25	3.10	US

Dominator
 Pry Bars
 Scrapers
 Chisels
 Punches
**Steel Sets/
 Kits**
 Specialty &
 Extractors
 Retail
 Displays
 Brass Sets/
 Kits
 150
 Hard Cap
 Hollow Punch
 Sets
 Automotive/
 Specialty
 Pneumatic
 18

The following category matrices provide a detailed breakdown by SKU for the sets listed previously.

Chisels



60560
6 PC COLD CHISEL



61506
5 PC COLD CHISEL

SET NO.		60560	61505	61506	61510	61512	61518
SET DESCRIPTION		6 PC COLD CHISEL	5 PC COLD CHISEL	5 PC COLD CHISEL	10 PC COLD CHISEL	5 PC LONG COLD CHISEL	3 PC XL COLD CHISEL
ITEM NO.	ITEM DESCRIPTION	SET CONTENTS					
10200	CHISEL COLD 1/4-6mm X 5 ON 1/4 HX	•	•		•		
10237	CHISEL COLD 9/32-7mm X 5 ON 1/4 HX			•	•		
10201	CHISEL COLD 5/16-8mm X 5 ON 1/4 HX	•	•		•		
10202MAY	CHISEL COLD 3/8-10mm X 5-1/2 ON 5/16 HX	•		•	•		
10204	CHISEL COLD 7/16-11mm X 6 ON 3/8 HX		•		•		
10205	CHISEL COLD 1/2-13mm X 6 ON 7/16 HX	•		•	•		
10209	CHISEL COLD 5/8-16mm X 6-1/2 ON 1/2 HX	•	•		•		
10212	CHISEL COLD 3/4-19mm X 7 ON 5/8 HX	•		•	•		
10216	CHISEL COLD 7/8-22mm X 7-1/2 ON 3/4 HX		•		•		
10220	CHISEL COLD 1-25mm X 8 ON 7/8 HX			•	•		
10207	CHISEL COLD 1/2-13mm X 12 ON 7/16 HX					•	
10210	CHISEL COLD 5/8-16mm X 12 ON 1/2 HX					•	
10213	CHISEL COLD 3/4-19mm X 12 ON 5/8 HX					•	
10217	CHISEL COLD 7/8-22mm X 12 ON 3/4 HX					•	
10221	CHISEL COLD 1-25mm X 12 ON 3/4 HX					•	
10215	CHISEL COLD 3/4-19mm X 18 ON 5/8 HX						•
10219	CHISEL COLD 7/8-22mm X 18 ON 3/4 HX						•
10222	CHISEL COLD 1-25mm X 18 ON 3/4 HX						•
Package Type: B = Blister C = Clamshell T = Tray							
R = Rack KB=Kit Bag P=Pouch X = Bulk Box W = Wooden Box		KB	KB	P	KB	X	X
Build-A-Set: 1 = Set in Full Storage Unit							
1a = Set in Storage Unit with room for expansion			1a	1b	1	2	3
1b = Set in Pouch to fill Storage Unit							

Build your full range assortment, one set at a time, or go complete with one kit.

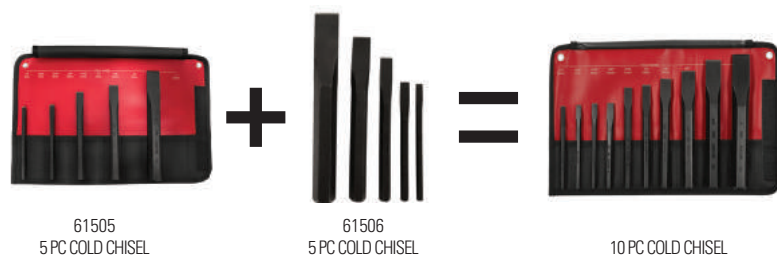

1A

1B

1

Build-A-Set: 1 = Set in Full Storage Unit

1a = Set in Storage Unit with room for expansion

1b = Set in Pouch to fill Storage Unit



Mayhew Steel Products, Inc.
199 Industrial Blvd.
Turners Falls, MA 01376

U.S. Toll-Free Customer Service: 800-872-0037
Visit us online at www.Mayhew.com
Always wear safety goggles when using hand tools.

Version 2.2016
For the latest version, visit us
online at www.Mayhew.com

The Pros Know

Dominator

Pry Bars

Scrapers

Chisels

Punches

Steel Sets/
Kits

Specialty &
Extractors

Retail
Displays

Brass Sets/
Kits

150

Hard Cap

Hollow Punch
Sets

Automotive/
Specialty

Pneumatic

19

Center-Solid Punch

Dominator
 Pry Bars
 Scrapers
 Chisels
 Punches
**Steel Sets/
Kits**
 Specialty &
 Extractors
 Retail
 Displays
 Brass Sets/
 Kits
 150
 Hard Cap
 Hollow Punch
 Sets
 Automotive/
 Specialty
 Pneumatic
 20



62212
12 PC CENTER & PRICK



62207
7 PC CENTER & PRICK



61340
6 PC SOLID PUNCH



SET NO.		62207	60007	62214	62212	62215	61340
SET DESCRIPTION		7 PC CENTER & PRICK	7 PC CENTER PUNCH	5 PC CENTER PUNCH	12 PC CENTER & PRICK	4 PC CENTER PUNCH	6 PC SOLID PUNCH
ITEM NO.	ITEM DESCRIPTION	SET CONTENTS					
23000	PUNCH PRICK 3/32-2.5mm x 4 ON 1/4 HX	•			•		
23003	PUNCH PRICK 1/8-3mm x 6 ON 1/2 HX						
23002	PUNCH PRICK 5/32-4mm x 5 ON 3/8 HX	•			•		
23001	PUNCH PRICK 3/16-5mm x 4-1/2 ON 5/16 HX	•			•		
24005	PUNCH CENTER 1/16-1.5mm x 4 ON 1/4 HX	•	•		•		
24006	PUNCH CENTER 5/64-2mm x 4 ON 1/4 HX	•	•		•	•	
24000	PUNCH CENTER 3/32-2.5mm x 4 ON 1/4 HX		•	•	•		
24007	PUNCH CENTER 1/8-3mm x 4-1/4 ON 5/16 HX	•	•		•	•	
24001	PUNCH CENTER 5/32-4mm x 4-1/2 ON 5/16 HX		•	•	•		
24002	PUNCH CENTER 3/16-5mm x 5 ON 3/8 HX		•	•	•	•	
24008	PUNCH CENTER 1/4-6mm x 5-1/2 ON 7/16 HX	•	•		•		
24003	PUNCH CENTER 5/16-8mm x 6 ON 1/2 HX			•	•	•	
24004	PUNCH CENTER 3/8-10mm x 6-1/4 ON 5/8 HX			•	•		
20000	PUNCH SOLID 3/32-2.5mm X 5 ON 3/8 HX						•
20001	PUNCH SOLID 1/8 X 5 ON 3/8 HX						•
20005	PUNCH SOLID 5/32-4mm X 5 ON 3/8 HX						•
20002	PUNCH SOLID 3/16 X 5 ON 3/8 HX						•
20003	PUNCH SOLID 1/4 X 5 ON 3/8 HX						•
20105	PUNCH SOLID 5/16-8mm X 6 ON 1/2 HX						•
Package Type: B = Blister C = Clamshell T = Tray R = Rack KB=Kit Bag P=Pouch X = Bulk Box W = Wooden Box		KB	KB	P	KB	P	P
Build-A-Set: 1 = Set in Full Storage Unit							
1a = Set in Storage Unit with room for expansion		1a		1b	1		2
1b = Set in Pouch to fill Storage Unit							

Build your full range assortment, one set at a time, or go complete with one kit.

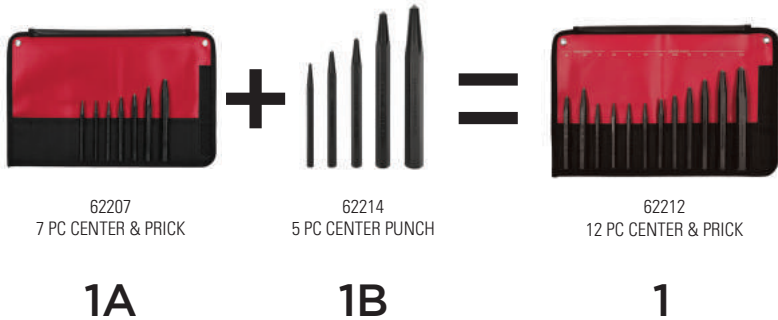



61341
16 PC PUNCH MIX



62077
10 PC PUNCH MIX



61810
4 PC ALIGNING PUNCH



61811
6 PC ALIGNING PUNCH

Punch Mix

SET NO.		62077	61341
SET DESCRIPTION		10 PC PUNCH MIX	16 PC PUNCH MIX
ITEM NO.	ITEM DESCRIPTION	SET CONTENTS	
24001	PUNCH CENTER 5/32-4mm x 4-1/2 ON 5/16 HX	•	
20000	PUNCH SOLID 3/32-2.5mm X 5 ON 3/8 HX		•
20001	PUNCH SOLID 1/8 X 5 ON 3/8 HX	•	•
20005	PUNCH SOLID 5/32-4mm X 5 ON 3/8 HX		•
20002	PUNCH SOLID 3/16 X 5 ON 3/8 HX		•
20003	PUNCH SOLID 1/4 X 5 ON 3/8 HX		•
20105	PUNCH SOLID 5/16-8mm X 6 ON 1/2 HX		•
20301	PUNCH SOLID 3/8 X 6-1/2 ON 1/2 HX		•
21000	PUNCH PIN 1/16 X 3/4 X 4 ON 1/4 HX		•
21001	PUNCH PIN 3/32 X 7/8 X 4-1/2 ON 5/16 HX	•	•
21002	PUNCH PIN 1/8 X 1 X 4-3/4 ON 5/16 HX	•	•
21003	PUNCH PIN 5/32 X 1 X 5 ON 5/16 HX	•	•
21004	PUNCH PIN 3/16 X 1-1/4 X 5-1/4 ON 3/8 HX	•	•
21011	PUNCH PIN 7/32 X 1-1/4 X 5-1/2 ON 3/8 HX	•	•
21005	PUNCH PIN 1/4 X 1-1/4 X 5-3/4 ON 3/8 HX	•	•
21019	PUNCH PIN 5/16 X 1-1/4 X 6 ON 7/16 HX		•
21014	PUNCH PIN 3/8 X 1-1/4 X 6-1/4 ON 1/2 HX		•
21503	PUNCH PIN 5/16 X 3-1/2 X 8 ON 7/16 HX	•	
21504	PUNCH PIN 3/8 X 3-1/2 X 8 ON 1/2 HX	•	
Package Type: B = Blister C = Clamshell T = Tray R = Rack KB=Kit Bag P=Pouch X = Bulk Box W = Wooden Box		KB	KB
Build-A-Set: 1 = Set in Full Storage Unit			
1a = Set in Storage Unit with room for expansion			
1b = Set in Pouch to fill Storage Unit			

Aligning Punches

SET NO.		61810	61811	62235
SET DESCRIPTION		4 PC ALIGNING PUNCH	6 PC ALIGNING PUNCH	4 PC LINE-UP PUNCH
ITEM NO.	ITEM DESCRIPTION	SET CONTENTS		
22021	PUNCH ALIGNING 3/32-2.5mm X 8 ON 5/16 HX			
22010	PUNCH ALIGNING 1/8-3mm X 8 ON 5/16 HX		•	•
22011	PUNCH ALIGNING 5/32-4mm X 9 ON 3/8 HX		•	•
22006	PUNCH ALIGNING 3/16 X 12 ON 3/8 HX			
22012	PUNCH ALIGNING 3/16 X 10 ON 1/2 HX		•	•
22025	PUNCH ALIGNING 7/32 X 10 ON 1/2 HX		•	
22003	PUNCH ALIGNING 1/4 X 12 ON 5/8 HX		•	•
22005	PUNCH ALIGNING 1/4 X 15 ON 3/4 HX	•		
22013	PUNCH ALIGNING 5/16-8mm X 12 ON 5/8 HX		•	
22008	PUNCH ALIGNING 5/16 X 16 ON 5/8 HX	•		
22017	PUNCH ALIGNING 3/8 X 15 ON 3/4 HX	•		
22024	PUNCH ALIGNING 1/2 X 18 ON .875 HX	•		
Package Type: B = Blister C = Clamshell T = Tray R = Rack KB=Kit Bag P=Pouch X = Bulk Box W = Wooden Box		KB	KB	KB
Build-A-Set: 1 = Set in Full Storage Unit				
1a = Set in Storage Unit with room for expansion		1	2	
1b = Set in Pouch to fill Storage Unit				

Pin Punches

- Dominator
- Pry Bars
- Scrapers
- Chisels
- Punches
- Steel Sets/
Kits
- Specialty &
Extractors
- Retail
Displays
- Brass Sets/
Kits
- 150
- Hard Cap
- Hollow Punch
Sets
- Automotive/
Specialty
- Pneumatic



62078
12 PC PIN PUNCH (INCH)



62065
5 PC LONG PIN PUNCH (INCH)



62081
6 PC LONG PIN PUNCH (MM)

SET NO.	62076	62074	62078	62065	66254	66255	66252	66253	62081
SET DESCRIPTION	6 PC PIN PUNCH (INCH)	6 PC PIN PUNCH (INCH)	12 PC PIN PUNCH (INCH)	5 PC LONG PIN PUNCH (INCH)	6 PC PIN PUNCH (MM)	5 PC PIN PUNCH (MM)	9 PC PIN PUNCH (MM)	11 PC PIN PUNCH (MM)	6 PC LONG PIN PUNCH (MM)
ITEM NO.	SET CONTENTS								
21000		•	•						
21010		•	•						
21001		•	•						
21002	•		•						
21003	•		•						
21004	•		•						
21011	•		•						
21005	•		•						
21019	•		•						
21014		•	•						
21016		•	•						
21017		•	•						
21500				•					
21501				•					
21502				•					
21503				•					
21504				•					
21240						•	•	•	
21241						•	•	•	
21242						•	•	•	
21243					•		•	•	
21244					•		•	•	
21245					•		•	•	
21246					•		•	•	
21247					•		•	•	
21248					•		•	•	
21249						•		•	
21227						•		•	
21508									•
21510									•
21512									•
21514									•
21518									•
21520									•
Package Type: B = Blister C = Clamshell T = Tray R = Rack KB=Kit Bag P=Pouch X= Bulk Box W= Wooden Box	KB	P	KB	KB	KB	P	KB	KB	KB
Build-A-Set: 1 = Set in Full Storage Unit 1a = Set in Storage Unit with room for expansion 1b = Set in Pouch to fill Storage Unit	1a	1b	1	2	3a	3b		3	4

Build your full range assortment, one set at a time, or go complete with one kit.

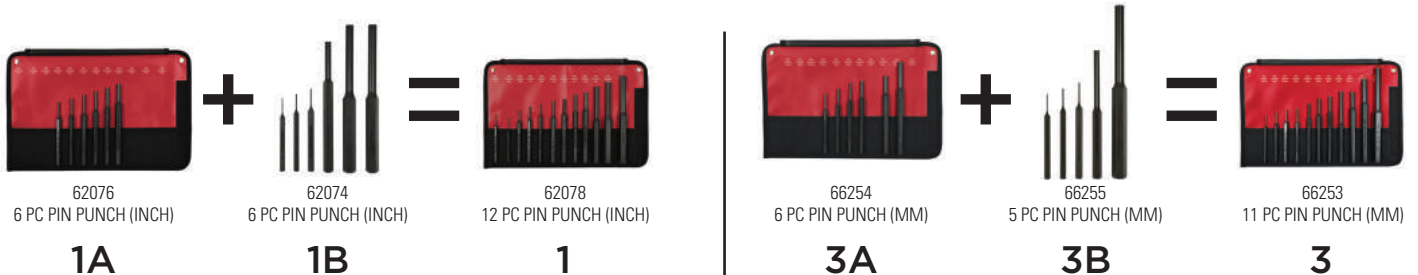

Punch & Chisel Mix



61005
6 PC PUNCH & CHISEL (INCH)



61050
24 PC PUNCH & CHISEL (INCH)



61044
14 PC PUNCH & CHISEL (INCH)



61019
19 PC PUNCH & CHISEL (INCH)

SET NO.		61005	61406	61409	61412	61044	61019	62287	61050	62256	62257	66258	66287	61080	
	SET DESCRIPTION	6 PC PUNCH & CHISEL (INCH)	6 PC PUNCH & CHISEL (INCH)	9 PC PUNCH & CHISEL (INCH)	12 PC PUNCH & CHISEL (INCH)	14 PC PUNCH & CHISEL (INCH)	19 PC PUNCH & CHISEL (INCH)	20 PC PUNCH & CHISEL (INCH)	24 PC PUNCH & CHISEL (INCH)	6 PC PUNCH & CHISEL (MM)	9 PC PUNCH & CHISEL (MM)	12 PC PUNCH & CHISEL (MM)	20 PC PUNCH & CHISEL (MM)	24 PC MECHANICS BENCH SET	
ITEM NO.	ITEM DESCRIPTION	SET CONTENTS													
10200	CHISEL COLD 1/4-6mm X 5 ON 1/4 HX		•				•	•	•	•				•	•
10237	CHISEL COLD 9/32-7mm X 5 ON 1/4 HX				•						•				
10201	CHISEL COLD 5/16-8mm X 5 ON 1/4 HX				•				•				•		•
10202MAY	CHISEL COLD 3/8-10mm X 5-1/4 ON 5/16 HX				•		•	•	•		•			•	•
10204	CHISEL COLD 7/16-11mm X 6 ON 3/8 HX		•							•					
10205	CHISEL COLD 1/2-13mm X 6 ON 7/16 HX	•			•	•	•	•	•				•	•	•
10209	CHISEL COLD 5/8-16mm X 6-1/2 ON 1/2 HX	•	•		•	•	•	•	•				•	•	•
10212	CHISEL COLD 3/4-19mm X 7 ON 5/8 HX				•	•	•	•	•				•	•	•
23000	PUNCH PRICK 3/32-2.5mm x 4 ON 1/4 HX				•						•				
23003	PUNCH PRICK 1/8-3mm x 6 ON 1/2 HX														•
23002	PUNCH PRICK 5/32-4mm x 5 ON 3/8 HX					•							•		•
23001	PUNCH PRICK 3/16-5mm x 4-1/2 ON 5/16 HX								•	•				•	
24007	PUNCH CENTER 1/8-3mm x 4-1/4 ON 5/16 HX				•						•				
24001	PUNCH CENTER 5/32-4mm x 4-1/2 ON 5/16 HX							•							
24002	PUNCH CENTER 3/16-5mm x 5 ON 3/8 HX	•	•			•	•	•	•	•				•	•
24003	PUNCH CENTER 5/16-8mm x 6 ON 1/2 HX				•				•	•			•	•	•
20000	PUNCH SOLID 3/32-2.5mm X 5 ON 3/8 HX						•	•	•	•				•	•
20020	PUNCH SOLID 3mm X 5 ON 3/8 HX										•			•	
20001	PUNCH SOLID 1/8 X 5 ON 3/8 HX				•		•	•	•	•				•	•
20005	PUNCH SOLID 5/32-4mm X 5 ON 3/8 HX		•						•	•				•	
20002	PUNCH SOLID 3/16 X 5 ON 3/8 HX	•				•	•	•	•	•				•	•
20026	PUNCH SOLID 6mm X 5 ON 3/8 HX												•	•	
20003	PUNCH SOLID 1/4 X 5 ON 3/8 HX					•		•	•	•				•	•
20105	PUNCH SOLID 5/16-8mm X 6 ON 1/2 HX								•	•					
22021	PUNCH ALIGNING 3/32-2.5MM X 8 ON 5/16 HX								•	•					
22010	PUNCH ALIGNING 1/8-3mm X 8 ON 5/16 HX												•	•	
21000	PUNCH PIN 1/16 X 3/4 X 4 ON 1/4 HX				•										
21010	PUNCH PIN 5/64 X 3/4 X 4-1/4 ON 1/4 HX				•										
21001	PUNCH PIN 3/32 X 7/8 X 4-1/2 ON 5/16 HX				•		•	•	•	•					•
21002	PUNCH PIN 1/8 X 1 X 4-3/4 ON 5/16 HX	•	•	•			•	•	•	•					•
21003	PUNCH PIN 5/32 X 1 X 5 ON 5/16 HX				•		•	•	•	•					•
21004	PUNCH PIN 3/16 X 1-1/4 X 5-1/4 ON 3/8 HX	•			•	•	•	•	•	•					•
21011	PUNCH PIN 7/32 X 1-1/4 X 5-1/2 ON 3/8 HX				•										•
21005	PUNCH PIN 1/4 X 1-1/4 X 5-3/4 ON 3/8 HX				•	•	•	•	•	•					•
21019	PUNCH PIN 5/16 X 1-1/4 X 6 ON 7/16 HX				•		•	•	•	•					•
21014	PUNCH PIN 3/8 X 1-1/4 X 6-1/4 ON 1/2 HX					•									•
21240	PUNCH PIN 1.5mm X 3/4 X 4 ON 1/4 HX										•				
21241	PUNCH PIN 2mm X 3/4 X 4-1/4 ON 1/4 HX										•				
21242	PUNCH PIN 2.5mm X 7/8 X 4-1/2 ON 5/16 HX										•			•	
21243	PUNCH PIN 3mm X 1 X 4-3/4 ON 5/16 HX										•			•	
21244	PUNCH PIN 4mm X 1 X 5 ON 5/16 HX										•			•	
21245	PUNCH PIN 5mm X 1-1/4 X 5-1/4 ON 3/8 HX										•			•	
21246	PUNCH PIN 6mm X 1-1/4 X 5-1/2 ON 3/8 HX										•			•	
21247	PUNCH PIN 8mm X 1-1/4 X 6 ON 7/16 HX										•			•	
21248	PUNCH PIN 10mm X 1-1/4 X 6-1/4 ON 1/2 HX										•			•	
21249	PUNCH PIN 12mm X 1-1/4 X 6-1/2 ON 5/8 HX										•			•	
50301	PUNCH-CHISEL HOLDER IN HANDLE							•						•	
10402MAY	CHISEL CAPE 1/4 X 5-5/8 ON 3/8 HX								•						•
10502MAY	CHISEL CAPE R-NOSE 1/4 X 5-5/8 ON 3/8 HX								•						•
10602MAY	CHISEL DIA PT 1/4 X 5-3/4 ON 3/8 HX								•						•
10404	CAPE CHISEL 3/8 X 7 ON 5/8 HEX														•
11300	RIVET BUSTER														•
	Package Type: B = Blister C = Clamshell T = Tray R = Rack KB=Kit Bag P=Pouch X=Bulk Box W=Wooden Box	KB	KB	KB	KB	KB	KB	KB	KB	KB	KB	KB	KB	KB	W
	Build-A-Set: 1 = Set in Full Storage Unit														
	1a = Set in Storage Unit with room for expansion		1a	1b	1c					2a	2b	2c			
	1b = Set in Pouch to fill Storage Unit														

Dominator
 Pry Bars
 Scrapers
 Chisels
 Punches
 Steel Sets/
 Kits
 Specialty &
 Extractors
 Retail
 Displays
 Brass Sets/
 Kits
 150
 Hard Cap
 Hollow Punch
 Sets
 Automotive/
 Specialty
 Pneumatic



Mayhew Steel Products, Inc.
199 Industrial Blvd.
Turners Falls, MA 01376

U.S. Toll-Free Customer Service: 800-872-0037
Visit us online at www.Mayhew.com
Always wear safety goggles when using hand tools.

Version 2.2016
For the latest version, visit us
online at www.Mayhew.com

The Pros Know

Pilot Punches

SET NO.		62250	62253	62255	62252	62254	62258	66265	66264	66261	66262	66263
SET DESCRIPTION		6 PC PILOT PUNCH (INCH)	6 PC PILOT PUNCH (INCH)	6 PC PILOT PUNCH (INCH)	9 PC PILOT PUNCH (INCH)	12 PC PILOT PUNCH (INCH)	12 PC PILOT PUNCH (INCH)	6 PC PILOT PUNCH (MM)	5 PC PILOT PUNCH (MM)	6 PC PILOT PUNCH (MM)	9 PC PILOT PUNCH (MM)	11 PC PILOT PUNCH (MM)
ITEM NO.	ITEM DESCRIPTION	SET CONTENTS										
25000	PUNCH PILOT 1/16 X 2-3/4 ON 1/4 RD-KNURL			•	•	•	•					
25001	PUNCH PILOT 5/64 X 3-1/4 ON 1/4 RD-KNURL			•	•	•	•					
25002	PUNCH PILOT 3/32 X 3-1/2 ON 1/4 RD-KNURL			•	•	•	•					
25003	PUNCH PILOT 1/8 X 4 ON 1/4 RD-KNURL	•	•		•	•	•					
25004	PUNCH PILOT 5/32 X 4-1/2 ON 1/4 RD-KNURL	•	•		•	•	•					
25005	PUNCH PILOT 3/16 X 4-1/2 ON 3/8 RD-KNURL	•	•		•	•	•					
25006	PUNCH PILOT 7/32 X 5 ON 3/8 RD-KNURL	•	•		•	•	•					
25007	PUNCH PILOT 1/4 X 5-1/2 ON 7/16 RD-KNURL	•	•		•	•	•					
25008	PUNCH PILOT 5/16 X 6 ON 7/16 RD-KNURL	•	•		•	•	•					
25009	PUNCH PILOT 3/8 X 6 ON 1/2 RD-KNURL			•		•	•					
25010	PUNCH PILOT 7/16 X 6 ON 5/8 RD-KNURL			•		•	•					
25011	PUNCH PILOT 1/2 X 6 ON 5/8 RD-KNURL			•		•	•					
25014	PUNCH PILOT 1.5mm X 2-3/4 ON 1/4 RD-KNURL								•		•	•
25015	PUNCH PILOT 2mm X 3-1/4 ON 1/4 RD-KNURL								•		•	•
25016	PUNCH PILOT 2.5mm X 3-1/2 ON 1/4 RD-KNURL								•		•	•
25017	PUNCH PILOT 3mm X 4 ON 1/4 RD-KNURL							•		•	•	•
25018	PUNCH PILOT 3.5mm X 4 ON 1/4 RD-KNURL							•		•	•	•
25019	PUNCH PILOT 4mm X 4-1/2 ON 1/4 RD-KNURL							•		•	•	•
25021	PUNCH PILOT 5mm X 4-1/2 ON 3/8 RD-KNURL							•		•	•	•
25023	PUNCH PILOT 6mm X 5-1/2 ON 7/16 RD-KNURL							•		•	•	•
25029	PUNCH PILOT 8mm X 6 ON 7/16 RD-KNURL							•		•	•	•
25026	PUNCH PILOT 10mm X 6 ON 1/2 RD-KNURL								•			•
25028	PUNCH PILOT 12mm X 6 ON 5/8 RD-KNURL								•			•
Package Type: B = Blister C = Clamshell T = Tray R = Rack KB=Kit Bag P=Pouch X = Bulk Box W = Wooden Box		KB	KB	P	KB	KB	W	KB	P	KB	KB	KB
Build-A-Set: 1 = Set in Full Storage Unit 1a = Set in Storage Unit with room for expansion 1b = Set in Pouch to fill Storage Unit			1a	1b		1		2a	2b			2

Build your full range assortment, one set at a time, or go complete with one kit.

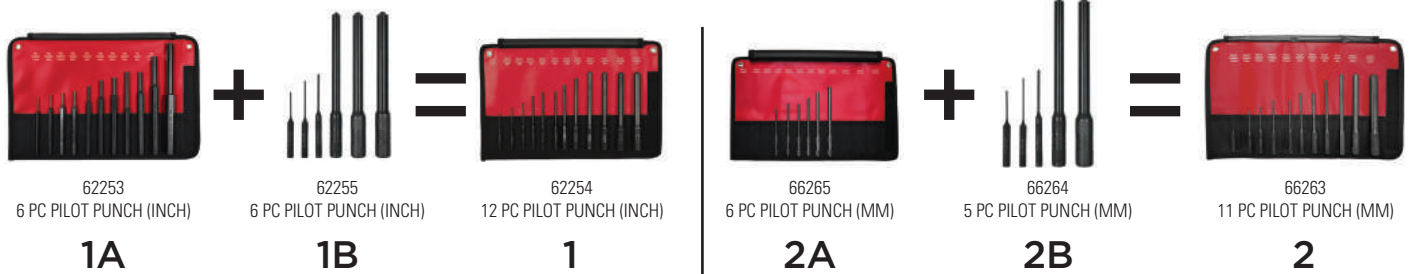



62250
6 PC PILOT PUNCH (INCH)



62254
12 PC PILOT PUNCH (INCH)



62252
9 PC PILOT PUNCH (INCH)



66263
11 PC PILOT PUNCH (MM)



66261
6 PC PILOT PUNCH (MM)



66262
9 PC PILOT PUNCH (MM)



Mayhew Steel Products, Inc.
199 Industrial Blvd.
Turners Falls, MA 01376

U.S. Toll-Free Customer Service: 800-872-0037
Visit us online at www.Mayhew.com
Always wear safety goggles when using hand tools.

Version 2.2016
For the latest version, visit us
online at www.Mayhew.com

The Pros Know



37019 – Seal Puller

Specialty Tools

Item	Description	UPC Code	OAL	Body Size	Body Type	Blade Width	Blade Style	Weight (Lbs)	Pkg. Type
01300	5/8" X 7-3/4" Short Nose Caulk Iron	081243013002	7-3/4	1/2	Hex	5/8	N/A	0.41	Bulk
01360	5/8" X 7-3/4" Short Nose Caulk Iron	081243013606	7-3/4	1/2	Hex	5/8	N/A	0.4	Bulk
01370	5/8" X 7-3/4" Short Nose Caulk Iron	081243013705	7-3/4	1/2	Hex	5/8	N/A	0.41	Bulk
02400	5/8" X 12" Packing Tool	081243024008	12	1/2	Hex	5/8	N/A	0.62	Bulk
02800	1-1/2" X 8" Broad Curved Nose Caulk Iron	081243028006	8-1/8	5/8	Hex	1-1/2	N/A	0.4	Bulk
37002	12 oz Welders Chip Hammer	045256370026	6	1/2	Hex	1/4	N/A	2.81	Bulk
37003	16 oz Welders Chip Hammer	045256370033	7-1/2	3/4	Hex	7/8	N/A	2.57	Bulk
37019	Seal Puller	045256370194	14	1/2	Hex	1/4	N/A	1.19	Bulk
50301	PUNCH-CHISEL HOLDER	045256503011	N/A	HANDLE	N/A	N/A	N/A	0.61	Bulk



Screw Extractors

- Used for removing broken or seized screws
- A wide range of sizes available for any screw size
- Hardened steel edges for easy removal of damaged screws
- Fluted cutting edges for cutting into screw shaft
- Made in the USA

Item	Description	UPC Code	OAL	Body Size	Body Type	Blade Width	Blade Style	Weight (Lbs)	Pkg. Type
36961	Screw Extractor D 1/8" S 1/4"-5/16	0 45256 36961 7	2-7/16	3/16	Square	1/8	N/A	0.02	Bulk
36962	Screw Extractor D 3/16" S 3/8"	0 45256 36962 4	2-5/8	3/16	Square	3/8	N/A	0.02	Bulk
36963	Screw Extractor D 15/64" S 7/16"	0 45256 36963 1	2-7/8	1/4	Square	15/64	N/A	0.04	Bulk
36964	Screw Extractor D 5/16" S 1/2-9/16	0 45256 36964 8	3	5/16	Square	5/16	N/A	0.07	Bulk
36965	Screw Extractor D 3/8" S 5/8"	0 45256 36965 5	3-1/4	3/8	Square	11/32	N/A	0.11	Bulk
36966	Screw Extractor D 15/32" S 3/4"	0 45256 36966 2	3-7/8	1/2	Square	7/16	N/A	0.21	Bulk
36967	Screw Extractor D 9/16" D 7/8"	0 45256 36967 9	4-1/2	1/2	Square	1/2	N/A	0.27	Bulk
36968	Screw Extractor 21/32" S 1-1/8"	0 45256 36968 6	4-7/8	5/8	Square	21/32	N/A	0.44	Bulk
36969	Screw Extractor D 13/16" S 1-3/8"	0 45256 36969 3	5-3/8	3/4	Square	23/32	N/A	0.70	Bulk



- 10 piece set includes sizes 6.00mm (1/4") - 38.00mm (1-1/2")
- Manufactured from hardened steel with fluted edges makes for easy removal of broken or damaged screws, bolts, studs, and pipes
- An open space for the proper drill size has been molded into the case for the storage of the corresponding drills.
- Made in USA

10 PC Screw Extractor Set

Item	Description	UPC Code	OAL	Body Size	Body Type	Blade Width	Blade Style	Weight (Lbs)	Pkg. Type
37345	10 PC Bolt Extractor Set in Case (SAE)	0 4525637345 5	XX	N/A	N/A	N/A	N/A	0.XX	Box
37348	10 PC Bolt Extractor Set in Case (Metric)	0 4525637348 5	XX	N/A	N/A	N/A	N/A	0.XX	Box

Dominator
Pry Bars
Scrapers
Chisels
Punches
Steel Sets/
Kits
Specialty &
Extractors
Retail
Displays
Brass Sets/
Kits
150
Hard Cap
Hollow Punch
Sets
Automotive/
Specialty
Pneumatic
26

27 PC Screw Extractor Set



80002 – 36 Pc Pilot Punch Display

Item	Description	UPC Code	OAL	Body Size	Body Type	Blade Width	Blade Style	Weight (Lbs)	Pkg. Type
80246	27 Pc Screw Extractor Set (3 ea) 36961 – D - 1/8" / S#10 - 5/16" (3) 36962 – D - 3/16" / S - 3/8" (3) 36963 – D - 15/64" / S - 7/16" (3) 36964 – D - 5/16" / S - 1/2-9/16" (3) 36965 – D - 3/8" / S - 5/8" (3) 36966 – D - 15/32" / S - 3/4" (3) 36967 – D - 9/16" / S - 7/8" (3) 36968 – D - 21/32" / S - 1-1/8" (3) 36969 – D - 13/16" / S - 1-3/8" (3)	0 45256 80002 8	N/A	N/A	N/A	N/A	N/A	3.2	Bulk



37331 – 4 Pc Screw Extractor Set



37332 – 5 Pc Screw Extractor Set

Extractor Sets

Item	Description	UPC Code	OAL	Body Size	Body Type	Blade Width	Blade Style	Weight (Lbs)	Pkg. Type
37331	4 Pc Screw Extractor Set 36966 – Screw Extractor D15/32" S3/4" 36967 – Screw Extractor D9/16" D7/8" 36968 – Screw Extractor 21/32" S1-1/8" 36969 – Screw Extractor D13/16" S1-3/8"	0 45256 37331 7	N/A	N/A	N/A	N/A	N/A	1.69	Pouch
37332	5 Pc Screw Extractor Set 36961 – Screw Extractor D1/8" S1/4"-5/16" 36962 – Screw Extractor D3/16" S3/8" 36963 – Screw Extractor D15/64" S7/16" 36964 – Screw Extractor D5/16" S1/2-9/16" 36965 – Screw Extractor D3/8" S5/8"	0 45256 37332 4	N/A	N/A	N/A	N/A	N/A	0.28	Pouch
65085	5 Pc Spiral Screw Extractor Kit	0 45256 65085 2	N/A	N/A	N/A	N/A	N/A	0.24	Pouch

Deck Wrecker Set

Item	Description	UPC Code	OAL	Body Size	Body Type	Blade Width	Blade Style	Weight (Lbs)	Pkg. Type
80030	3 Pc Deck Wrecker Display 41104 – Deck Wrecker	0 45256 80030 1	45-1/2	N/A	N/A	N/A	N/A	8.76	N/A

Screwdriver Set

Item	Description	UPC Code	OAL	Body Size	Body Type	Blade Width	Blade Style	Weight (Lbs)	Pkg. Type
37343	3 Pc Screwdriver Set 35218 – Screwdriver Phil #2 Pt 35724 – Screwdriver 5/16" x 28" 36019 – Screwdriver	0 45256 37343 0	N/A	N/A	N/A	N/A	N/A	3.18	Bulk



Mayhew Steel Products, Inc.
199 Industrial Blvd.
Turners Falls, MA 01376

U.S. Toll-Free Customer Service: 800-872-0037
Visit us online at www.Mayhew.com
Always wear safety goggles when using hand tools.

Version 2.2016
For the latest version, visit us
online at www.Mayhew.com

The Pros Know

Dominator

Pry Bars

Scrapers

Chisels

Punches

Steel Sets/
Kits

Specialty &
Extractors

Retail
Displays

Brass Sets/
Kits

150

Hard Cap

Hollow Punch
Sets

Automotive/
Specialty

Pneumatic

27

Retail Displays

Dominator
 Pry Bars
 Scrapers
 Chisels
 Punches
 Steel Sets/
 Kits
 Specialty &
 Extractors
**Retail
 Displays**
 Brass Sets/
 Kits
 150
 Hard Cap
 Hallow Punch
 Sets
 Automotive/
 Specialty
 Pneumatic
 28



80002 – 36PC PILOT PUNCH DISPLAY



80242 – 102 PC PUNCH AND CHISEL DISPLAY



80244 – 18 PC MASONARY DISPLAY



80246 – 27 PC SCREW EXTRACTOR DISPLAY



80247 – 57 PC PUNCH & CHISEL DISPLAY



80018 - 80019 – 24" DISPLAY, PUNCH&CHISEL 33/2-33/3



80235 – 90 PC PRO PUNCH & CHISEL DISPLAY

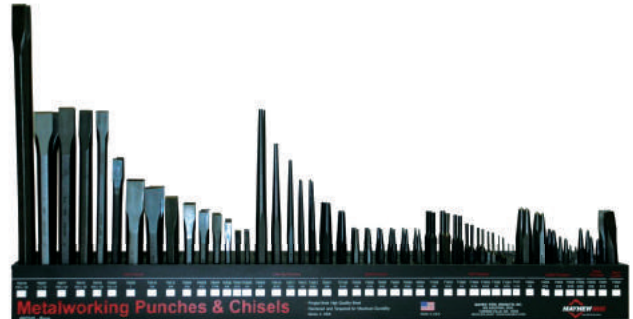

80240 – 132 PC, Punch & Chisel Display



80027 – Dominator 8 PC Large Pry Bar DISPLAY



80026 – STARTER PRY BAR DISPLAY



80260 – LARGE CLAMP DISPLAY

Dominator
 Pry Bars
 Scrapers
 Chisels
 Punches
 Steel Sets/
 Kits
 Specialty &
 Extractors
 Retail
 Displays
 Brass Sets/
 Kits
 150
 Hard Cap
 Hollow Punch
 Sets
 Automotive/
 Specialty
 Pneumatic
 29



Mayhew Steel Products, Inc.
 199 Industrial Blvd.
 Turners Falls, MA 01376

U.S. Toll-Free Customer Service: 800-872-0037
 Visit us online at www.Mayhew.com
 Always wear safety goggles when using hand tools.

Version 2.2016
 For the latest version, visit us
 online at www.Mayhew.com

The Pros Know

Non marring, non sparking USA brass punches and scrapers now offered in an improved smooth polished finish with a double knurled feature for more effective use. Whether the job requires a limited or the widest range of brass tools, Mayhew is the only professional solution to provide the requisite number of tools, within spec and with packaging that withstands typical harsh workplace environments.



Designed to remove gaskets and softer material where there is a concern of damaging the surface or causing sparks.

Brass Scraper

ITEM	DESCRIPTION	UPC	WEIGHT	LENGTH	WIDTH	BODY SIZE	CUT WIDTH	COO
10655	BRASS SCRAPER 3/8-10mm X 5-1/2	045256106557	0.22	5.5	N/A	.375	3/8"	US
10657	BRASS SCRAPER 1/2-13mm X 6	045256106571	.43	6	N/A	.500	1/2"	US
10658	BRASS SCRAPER 5/8-16mm X 6-1/2	045256106588	.79	6.5	N/A	.625	5/8"	US



Designed for loosening frozen or tight pins or knocking out rivets.

Brass Solid Punch

ITEM	DESCRIPTION	UPC	WEIGHT	LENGTH	BODY SIZE	TAPER LENGTH	TIP WIDTH	COO
25080	PUNCH SOLID 1/4 X 6	045256250809	0.43	6	.500	2	1/4" & 6mm	US



Used for driving out and removing already loosened pins after initial movement by a solid punch.

Brass Pin Punch

ITEM	DESCRIPTION	UPC	WEIGHT	LENGTH	BODY SIZE	TIP LENGTH	TIP WIDTH	COO
25700	PUNCH PIN 1/16 X 4	045256257006	0.07	4	.250	1/2	1/16"	US
25701	PUNCH PIN 5/64 X 4	045256257013	0.07	4	.250	5/8	5/64"	US
25702	PUNCH PIN 3/32 X 4	045256257020	0.07	4	.250	7/8	3/32"	US
25723	PUNCH PIN 1/8 X 4	045256257235	0.07	4	.250	1	1/8"	US
25704	PUNCH PIN 5/32 X 4	045256257044	0.17	4	.375	1-1/8	5/32"	US
25705	PUNCH PIN 3/16 X 4	045256257051	0.17	4	.375	1-1/4	3/16"	US
25706	PUNCH PIN 7/32 X 4	045256257068	0.17	4	.375	1-1/4	7/32"	US
25707	PUNCH PIN 1/4 X 4	045256257075	0.17	4	.375	1-1/4	1/4"	US
25708	PUNCH PIN 5/16 X 4	045256257082	0.30	4	.500	1-1/4	5/16"	US
25091	PUNCH PIN 3/8 X 6	045256250915	0.44	6	.500	1-3/4	3/8"	US
25709	PUNCH PIN 7/16 X 6	045256257099	0.73	6	.625	2	7/16"	US
25710	PUNCH PIN 1/2 X 6	045256257105	0.73	6	.625	2	1/2"	US
25711	PUNCH PIN 1.5MM X 4	045256257112	0.07	4	.250	1/2	1.5mm	US
25712	PUNCH PIN 2MM X 4	045256257129	0.07	4	.250	5/8	2mm	US
25713	PUNCH PIN 2.5MM X 4	045256257136	0.07	4	.250	7/8	2.5mm	US
25714	PUNCH PIN 3MM X 4	045256257143	0.07	4	.250	1	3mm	US
25715	PUNCH PIN 4MM X 4	045256257150	0.17	4	.375	1-1/8	4mm	US
25716	PUNCH PIN 5MM X 4	045256257167	0.17	4	.375	1-1/4	5mm	US
25717	PUNCH PIN 6MM X 4	045256257174	0.17	4	.375	1-1/4	6mm	US
25718	PUNCH PIN 8MM X 5	045256257181	0.30	5	.500	1-1/4	8mm	US
25719	PUNCH PIN 10MM X 6	045256257198	0.44	6	.500	1-3/4	10mm	US
25720	PUNCH PIN 12MM X 6	045256257204	0.73	6	.625	2	12mm	US

Dominator
Pry Bars
Scrapers
Chisels
Punches
Steel Sets/
Kits
Specialty &
Extractors
Retail
Displays
Brass Sets/
Kits
150
Hard Cap
Hollow Punch
Sets
Automotive/
Specialty
Pneumatic
30

Non marring, non sparking USA brass punches and scrapers now offered in an improved smooth polished finish with a double knurled feature for more effective use. Whether the job requires a limited or the widest range of brass tools, Mayhew is the only professional solution to provide the requisite number of tools, within spec and with packaging that withstands typical harsh workplace environments.



Used to transfer the force of a hammer blow to a specific location to remove or loosen a part or pin.

Brass Drift Punch

ITEM	DESCRIPTION	UPC	WEIGHT	LENGTH	WIDTH	BODY SIZE	TIP WIDTH	COO
25074	PUNCH DRIFT 1/4-6mm X 4	045256250748	0.07	4	N/A	.250	1/4" & 6mm	US
25077	PUNCH DRIFT 3/8-10mm X 6	045256250779	0.24	6	N/A	.375	3/8" & 10mm	US
25076	PUNCH DRIFT 1/2-13mm X 7	045256250762	0.50	7	N/A	.500	1/2" & 13mm	US
25073	PUNCH DRIFT 5/8-16mm X 8	045256250731	0.97	8	N/A	.625	5/8" & 16mm	US
25075	PUNCH DRIFT 3/4-19mm X 8	045256250755	1.40	8	N/A	.750	3/4" & 19mm	US
25078	PUNCH DRIFT 3/4-19mm X 12	045256250786	2.10	12	N/A	.750	3/4" & 19mm	US



Designed for aligning holes or parts in which rivets, pins, or bolts are inserted. By inserting the tapered end into semi-aligned holes, the punch can then be driven through the holes for perfect alignment.

Brass Line Up Punch

ITEM	DESCRIPTION	UPC	WEIGHT	LENGTH	BODY SIZE	TAPER LENGTH	TIP WIDTH	COO
25081	PUNCH LINE UP 11/32-9mm X 10	045256250816	1.75	10	.750	5.25	11/32" & 9mm	US
25095	PUNCH LINE UP 3/8-10mm X 10	045256250953	1.75	10	.750	5.25	3/8" & 10mm	US
25096	PUNCH LINE UP 7/16-11mm X 14	045256250809	2.45	14	.750	7.875	7/16" & 11mm	US



Originally invented by Mayhew. Also known as a rollpin punch. Designed for the small ball in the center of the pin tip to support the outer edge of the roll pin. Regular pin punches should not be used on roll or spring pins.

Brass Pilot Punch

ITEM	DESCRIPTION	UPC	WEIGHT	LENGTH	BODY SIZE	TIP LENGTH	TIP WIDTH	COO
25064	PUNCH PILOT 1/16 X 4	045256250649	0.07	4	.250	1/4	1/16"	US
25065	PUNCH PILOT 5/64 X 4	045256250656	0.07	4	.250	5/16	5/64"	US
25066	PUNCH PILOT 3/32 X 4	045256250663	0.07	4	.250	3/8	3/32"	US
25067	PUNCH PILOT 1/8 X 4	045256250670	0.07	4	.250	1/2	1/8"	US
25055	PUNCH PILOT 5/32 X 4	045256250557	0.17	4	.375	3/4	5/32"	US
25056	PUNCH PILOT 3/16 X 4	045256250564	0.17	4	.375	3/4	3/16"	US
25057	PUNCH PILOT 7/32 X 4	045256250571	0.17	4	.375	7/8	7/32"	US
25058	PUNCH PILOT 1/4 X 4	045256250588	0.17	4	.375	1	1/4"	US
25068	PUNCH PILOT 5/16 X 4	045256250687	0.30	4	.500	1-1/8	5/16"	US
25061	PUNCH PILOT 3/8 X 6	045256250618	0.44	6	.500	1-3/4	3/8"	US
25062	PUNCH PILOT 7/16 X 6	045256250625	0.73	6	.625	1-7/8	7/16"	US
25063	PUNCH PILOT 1/2 X 6	045256250632	0.73	6	.625	2	1/2"	US
25151	PUNCH PILOT 1.5MM X 4	045256251516	0.07	4	.250	1/4	1.5mm	US
25152	PUNCH PILOT 2MM X 4	045256251523	0.07	4	.250	5/16	2mm	US
25153	PUNCH PILOT 2.5MM X 4	045256251530	0.07	4	.250	3/8	2.5mm	US
25154	PUNCH PILOT 3MM X 4	045256251547	0.07	4	.250	1/2	3mm	US
25155	PUNCH PILOT 3.5MM X 4	045256251554	0.17	4	.375	5/8	3.5mm	US
25156	PUNCH PILOT 4MM X 4	045256251561	0.17	4	.375	3/4	4mm	US
25157	PUNCH PILOT 5MM X 4	045256251578	0.17	4	.375	7/8	5mm	US
25158	PUNCH PILOT 6MM X 4	045256251585	0.17	4	.375	1	6mm	US
25159	PUNCH PILOT 8MM X 4	045256251592	0.26	4	.500	1-1/8	8mm	US
25161	PUNCH PILOT 10MM X 6	045256251615	0.38	6	.500	1-3/4	10mm	US
25162	PUNCH PILOT 12MM X 6	045256251622	0.73	6	.625	2	12mm	US



Mayhew Steel Products, Inc.
199 Industrial Blvd.
Turners Falls, MA 01376

U.S. Toll-Free Customer Service: 800-872-0037
Visit us online at www.Mayhew.com
Always wear safety goggles when using hand tools.

Version 2.2016
For the latest version, visit us
online at www.Mayhew.com

The Pros Know

Dominator

Pry Bars

Scrapers

Chisels

Punches

Steel Sets/
Kits

Specialty &
Extractors

Retail
Displays

Brass Sets/
Kits

150

Hard Cap

Hollow Punch
Sets

Automotive/
Specialty

Pneumatic

31

Brass Sets

ITEM	DESCRIPTION	UPC	WEIGHT	LENGTH	WIDTH	HEIGHT	TIP WIDTH	COO
61360	3 PC BRASS DRIFT PUNCH SET	045256613604	1.75	10.5	3.75	1	N/A	US
67002	3 PC BRASS DRIFT PUNCH SET	045256670027	1.475	10.5	3.75	1	N/A	US
67003	5 PC BRASS DRIFT PUNCH SET	045256670034	2.685	9	2.5	1.75	N/A	US
61365	3 PC BRASS EXTRA LONG PUNCH SET	045256613659	4.35	15	2.5	1.5	N/A	US
61363	4 PC X-LONG BRASS PUNCH SET	045256613635	6.75	16	2	2	N/A	US
67004	3 PC BRASS PIN PUNCH (INCH) SET	045256670041	0.99	10.5	3.75	1	N/A	US
67007	6 PC BRASS PIN PUNCH (INCH) SET	045256670072	1.025	9	2.5	1.25	N/A	US
67009	4 PC BRASS PIN PUNCH (INCH) SET	045256670096	0.77	10.5	3.75	1	N/A	US
67008	12 PC BRASS PIN PUNCH (INCH) SET	045256670089	2.165	9	3	2	N/A	US
61387	10 PC BRASS PIN PUNCH (METRIC) SET	045256613871	1.735	9.25	3.25	1.75	N/A	US
62277	4 PC BRASS PUNCH (INCH) SET	045256622774	1.04	10	2.75	1	N/A	US
62278	4 PC BRASS PUNCH (INCH) SET	045256622781	1.04	10	2.75	1	N/A	US
61367	9 PC BRASS PILOT PUNCH (INCH) SET	045256613673	1.15	7	3	1.5	N/A	US
61388	9 PC BRASS PILOT PUNCH (METRIC) SET	045256613888	0.96	7	3	1.5	N/A	US
67001	3 PC BRASS SCRAPER SET	045256670010	1.13	9	1.75	1.5	N/A	US
67012	12 PC BRASS PUNCH & SCRAPER (INCH) SET	045256670126	2.375	9	3.5	2	N/A	US
61397	12 PC BRASS PUNCH & SCRAPER (METRIC) SET	045256613970	2.745	9	3.5	1.75	N/A	US
67015	15 PC BRASS PUNCH & SCRAPER SET	045256670157	9	21.5	8.5	1.5	N/A	US
67019	19 PC BRASS PUNCH & SCRAPER KIT	045256670195	5.55	8	5	2.5	N/A	US
61386	6 PC BRASS PIN PUNCH KIT (METRIC)	045256613864	1.2	9	2.5	1.25	N/A	US
61389	17 PC PUNCH & SCRAPER (METRIC)	045256613895	4.05	10	4	2	N/A	US



61365
3 PC BRASS EXTRA LONG
PUNCH SET



67004
3 PC BRASS PIN
PUNCH (INCH) SET



67003
5 PC BRASS DRIFT PUNCH SET



67002
3 PC BRASS DRIFT
PUNCH SET

The following category matrices provide a detailed breakdown by SKU for the sets listed previously.

Brass Drift & PC Line Up Punch Kits

SET NO.		67003	61363	67002	61360
SET DESCRIPTION		5 PC DRIFT PUNCH	4 PC EXTRA LONG PUNCH	3 PC DRIFT PUNCH	3 PC DRIFT PUNCH
ITEM NO.	ITEM DESCRIPTION	SET CONTENTS			
25074	DRIFT PUNCH 1/4"-6mm X 4 ON 1/4 RD	•			
25077	DRIFT PUNCH 3/8"-10mm X 6 ON 3/8 RD	•		•	•
25076	DRIFT PUNCH 1/2"-13mm X 7 ON 1/2 RD	•		•	•
25073	DRIFT PUNCH 5/8"-16mm X 8 ON 5/8 RD	•		•	
25075	DRIFT PUNCH 3/4"-19mm X 8 ON 3/4 RD	•			•
25078	DRIFT PUNCH 3/4"-19mm X 12 ON 3/4 RD		•		
25081	LINE-UP PUNCH 11/32"-9mm X 10 ON 3/4 RD		•		
25095	LINE-UP PUNCH 3/8"-10mm X 10 ON 3/4 RD		•		
25096	LINE-UP PUNCH 7/16"-11mm X 14 ON 3/4 RD		•		
Package Type: B = Blister C = Clamshell T = Tray		KB	KB	T	T
R = Rack KB=Kit Bag P=Pouch X = Bulk Box W = Wooden Box					

Brass Multi PC Punch Kits



67001
3 PC SCRAPER



67012
12 PC PUNCH & SCRAPER (INCH)



61397
12 PC PUNCH & SCRAPER (MM)

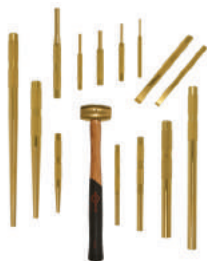

67015
15 PC PUNCH & SCRAPER

SET NO.		67001	62277	62278	67012	61397	67015	67019	61389
SET DESCRIPTION		3 PC SCRAPER	4 PC PUNCH (INCH)	4 PC PUNCH (INCH)	12 PC PUNCH & SCRAPER (INCH)	12 PC PUNCH & SCRAPER (MM)	15 PC PUNCH & SCRAPER	19 PC PUNCH & SCRAPER (INCH)	17 PC PUNCH & SCRAPER (MM)
ITEM NO.	ITEM DESCRIPTION	SET CONTENTS							
10655	SCRAPER 3/8"-10MM X 5-1/2 ON 3/8 RD	•			•	•	•	•	•
10657	SCRAPER 1/2"-13MM X 6 ON 1/2 RD	•			•	•	•	•	•
10658	SCRAPER 5/8"-16MM X 6-1/2 ON 5/8 RD	•							
25080	SOLID PUNCH 1/4" X 6 ON 1/2 RD		•				•		
25074	DRIFT PUNCH 1/4"-6mm X 4 ON 1/4 RD				•	•		•	•
25077	DRIFT PUNCH 3/8"-10mm X 6 ON 3/8 RD		•	•	•	•	•	•	•
25076	DRIFT PUNCH 1/2"-13mm X 7 ON 1/2 RD				•	•	•	•	•
25073	DRIFT PUNCH 5/8"-16mm X 8 ON 5/8 RD							•	•
25075	DRIFT PUNCH 3/4"-19mm X 8 ON 3/4 RD						•	•	•
25078	DRIFT PUNCH 3/4"-19mm X 12 ON 3/4 RD						•		
25081	LINE-UP PUNCH 11/32"-9mm X 10 ON 3/4 RD								
25095	LINE-UP PUNCH 3/8"-10mm X 10 ON 3/4 RD						•		
25096	LINE-UP PUNCH 7/16"-11mm X 14 ON 3/4 RD						•		
25700	PIN PUNCH 1/16" X 1/2 X 4 ON 1/4 RD							•	
25701	PIN PUNCH 5/64" X 5/8 X 4 ON 1/4 RD							•	
25702	PIN PUNCH 3/32" X 7/8 X 4 ON 1/4 RD							•	
25723	PIN PUNCH 1/8" X 1 X 4 ON 1/4 RD			•	•		•	•	
25704	PIN PUNCH 5/32" X 1-1/8 X 4 ON 3/8 RD				•			•	
25705	PIN PUNCH 3/16" X 1-1/4 X 4 ON 3/8 RD			•	•		•	•	
25706	PIN PUNCH 7/32" X 1-1/4 X 4 ON 3/8 RD				•			•	
25707	PIN PUNCH 1/4" X 1-1/4 X 4 ON 3/8 RD				•		•	•	
25090	PIN PUNCH 1/4" X 1-1/8 X 4 ON 1/2 RD		•						
25708	PIN PUNCH 5/16" X 1-1/2 X 4 ON 1/2 RD			•	•		•	•	
25091	PIN PUNCH 3/8" X 1-3/4 X 6 ON 1/2 RD		•		•		•	•	
25709	PIN PUNCH 7/16" X 2 X 6 ON 1/2 RD							•	
25710	PIN PUNCH 1/2" X 2 X 6 ON 5/8 RD							•	
25711	PIN PUNCH 1.5mm X 1/2 X 4 ON 1/4 RD								•
25712	PIN PUNCH 2mm X 5/8 X 4 ON 1/4 RD								•
25713	PIN PUNCH 2.5mm X 7/8 X 4 ON 1/4 RD								•
25714	PIN PUNCH 3mm X 1 X 4 ON 1/4 RD					•			•
25715	PIN PUNCH 4mm X 1-1/8 X 4 ON 3/8 RD					•			•
25716	PIN PUNCH 5mm X 1-1/4 X 4 ON 3/8 RD					•			•
25717	PIN PUNCH 6mm X 1-1/4 X 4 ON 3/8 RD					•			•
25718	PIN PUNCH 8mm X 1-1/2 X 4 ON 1/2 RD					•			•
25719	PIN PUNCH 10mm X 1-3/4 X 6 ON 1/2 RD					•			•
25720	PIN PUNCH 12mm X 2 X 6 ON 5/8 RD					•			•
25800	#1 BRASS HAMMER						•		
Package Type: B=Blister C=Clamshell T=Tray		KB	B	B	KB	KB	T	KB	KB
R=Rack KB=Kit Bag P=Pouch X=Bulk Box W=Wooden Box									

Dominator
 Pry Bars
 Scrapers
 Chisels
 Punches
 Steel Sets/
 Kits
 Specialty &
 Extractors
 Retail
 Displays
 Brass Sets/
 Kits
 150
 Hard Cap
 Hollow Punch
 Sets
 Automotive/
 Specialty
 Pneumatic



Mayhew Steel Products, Inc.
199 Industrial Blvd.
Turners Falls, MA 01376

U.S. Toll-Free Customer Service: 800-872-0037
Visit us online at www.Mayhew.com
Always wear safety goggles when using hand tools.

Version 2.2016
For the latest version, visit us
online at www.Mayhew.com

The Pros Know

Brass Pin Punch Kits



67004
3 PC PIN PUNCH SET



67009
4 PC PIN PUNCH SET



67007
6 PC BRASS PIN PUNCH SET



67008
12 PC BRASS PIN PUNCH SET



61387
10 PC BRASS PIN PUNCH SET



61367
9 PC PILOT PUNCH (INCH)



61388
9 PC PILOT PUNCH (METRIC)

SET NO.		67004	67007	67008	67009	61386	61387
SET DESCRIPTION		3 PC PIN PUNCH (INCH)	6 PC PIN PUNCH (INCH)	12 PC PIN PUNCH (INCH)	4 PC PIN PUNCH (INCH)	6 PC PIN PUNCH (METRIC)	10 PC PIN PUNCH (METRIC)
ITEM NO.	ITEM DESCRIPTION	SET CONTENTS					
25700	PIN PUNCH 1/16" X 1/2 X 4 ON 1/4 RD			•			
25701	PIN PUNCH 5/64" X 5/8 X 4 ON 1/4 RD			•			
25702	PIN PUNCH 3/32" X 7/8 X 4 ON 1/4 RD			•			
25723	PIN PUNCH 1/8" X 1 X 4 ON 1/4 RD		•	•	•		
25704	PIN PUNCH 5/32" X 1-1/8 X 4 ON 3/8 RD		•	•			
25705	PIN PUNCH 3/16" X 1-1/4 X 4 ON 3/8 RD		•	•	•		
25706	PIN PUNCH 7/32" X 1-1/4 X 4 ON 3/8 RD			•			
25707	PIN PUNCH 1/4" X 1-1/4 X 4 ON 3/8 RD	•	•	•			
25708	PIN PUNCH 5/16" X 1-1/2 X 4 ON 1/2 RD		•	•	•		
25091	PIN PUNCH 3/8" X 1-3/4 X 6 ON 1/2 RD	•	•	•			
25709	PIN PUNCH 7/16" X 2 X 6 ON 1/2 RD			•	•		
25710	PIN PUNCH 1/2" X 2 X 6 ON 5/8 RD	•		•			
25711	PIN PUNCH 1.5mm X 1/2 X 4 ON 1/4 RD						•
25712	PIN PUNCH 2mm X 5/8 X 4 ON 1/4 RD						•
25713	PIN PUNCH 2.5mm X 7/8 X 4 ON 1/4 RD						•
25714	PIN PUNCH 3mm X 1 X 4 ON 1/4 RD					•	•
25715	PIN PUNCH 4mm X 1-1/8 X 4 ON 3/8 RD					•	•
25716	PIN PUNCH 5mm X 1-1/4 X 4 ON 3/8 RD					•	•
25717	PIN PUNCH 6mm X 1-1/4 X 4 ON 3/8 RD					•	•
25718	PIN PUNCH 8mm X 1-1/2 X 4 ON 1/2 RD					•	•
25719	PIN PUNCH 10mm X 1-3/4 X 6 ON 1/2 RD					•	•
25720	PIN PUNCH 12mm X 2 X 6 ON 5/8 RD						•
Package Type: B=Blister C=Clamshell T=Tray		T	T	KB	KB	KB	KB
R=Rack KB=Kit Bag P=Pouch X=Bulk Box W=Wooden Box							

Brass Pilot Punch Kits

SET NO.		61367	61388
SET DESCRIPTION		9 PC PILOT PUNCH (INCH)	9 PC PILOT PUNCH (METRIC)
ITEM NO.	ITEM DESCRIPTION	SET CONTENTS	
25064	PILOT PUNCH 1/16" X 1/4 X 4 ON 1/4 RD	•	
25065	PILOT PUNCH 5/64" X 5/16 X 4 ON 1/4 RD	•	
25066	PILOT PUNCH 3/32" X 3/8 X 4 ON 1/4 RD	•	
25067	PILOT PUNCH 1/8" X 1/2 X 4 ON 1/4 RD	•	
25055	PILOT PUNCH 5/32" X 3/4 X 4 ON 3/8 RD	•	
25056	PILOT PUNCH 3/16" X 3/4 X 4 ON 3/8 RD	•	
25058	PILOT PUNCH 1/4" X 1 X 4 ON 3/8 RD	•	
25068	PILOT PUNCH 5/16" X 1-1/8 X 4 ON 1/2 RD	•	
25061	PILOT PUNCH 3/8" X 1-3/4 X 6 ON 1/2 RD	•	
25151	PILOT PUNCH 1.5mm X 1/4 X 4 ON 1/4 RD		•
25152	PILOT PUNCH 2mm X 5/16 X 4 ON 1/4 RD		•
25153	PILOT PUNCH 2.5mm X 3/8 X 4 ON 1/4 RD		•
25154	PILOT PUNCH 3mm X 1/2 X 4 ON 1/4 RD		•
25155	PILOT PUNCH 3.5mm X 5/8 X 4 ON 3/8 RD		•
25156	PILOT PUNCH 4mm X 3/4 X 4 ON 3/8 RD		•
25157	PILOT PUNCH 5mm X 7/8 X 4 ON 3/8 RD		•
25158	PILOT PUNCH 6mm X 1 X 4 ON 3/8 RD		•
25159	PILOT PUNCH 8mm X 1-1/4 X 4 ON 1/2 RD		•
25161	PILOT PUNCH 10mm X 1-3/4 X 6 ON 1/2 RD		•
Package Type: B=Blister C=Clamshell T=Tray			
R=Rack KB=Kit Bag P=Pouch X=Bulk Box W=Wooden Box		KB	KB

Dominator
Pry Bars
Scrapers
Chisels
Punches
Steel Sets/
Kits
Specialty &
Extractors
Retail
Displays
Brass Sets/
Kits
150
Hard Cap
Hollow Punch
Sets
Automotive/
Specialty
Pneumatic
34

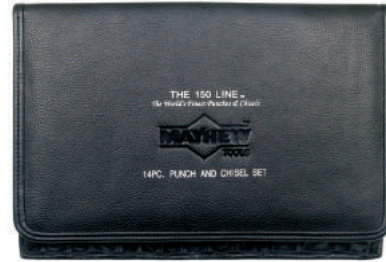

- High-grade S-2 steel for superior tensile strength, toughness, and long life
- Full shank heat treating and parabolic head to reduce mushrooming and chipping of struck end
- Professional black oxide finish for enhanced corrosion resistance
- Full, unconditional lifetime warranty

150 Line Chisels

Item	Description	UPC Code	OAL	Body Size	Body Type	Blade Width	Blade Style	Weight (Lbs)	Pkg. Type
15010	1/4" Cold Chisel, 150 Line	0 45256 15010 9	5	1/4	Hex	1/4	N/A	0.07	Bulk
15012	3/8" Cold Chisel, 150 Line	0 45256 15012 3	5-1/4	5/16	Hex	3/8	N/A	0.78	Bulk
15013	1/2" Cold Chisel, 150 Line	0 45256 15013 0	6	7/16	Hex	1/2	N/A	0.25	Bulk
15014	5/8" Cold Chisel, 150 Line	0 45256 15014 7	6-1/2	1/2	Hex	5/8	N/A	0.35	Bulk
15015	3/4" Cold Chisel, 150 Line	0 45256 15015 4	7	5/8	Hex	3/4	N/A	0.58	Bulk

150 Line Punches

Item	Description	UPC Code	OAL	Body Size	Body Type	Blade Width	Blade Style	Weight (Lbs)	Pkg. Type
15020	3/32" Center Punch, 150 Line	0 45256 15020 8	4	1/4	Hex	3/32	N/A	0.06	Bulk
15022	3/16" Pt Center Punch, 150 Line	0 45256 15022 2	5	3/8	Hex	3/16	N/A	0.15	Bulk
15040	1/8" Solid Punch, 150 Line	0 45256 15040 6	5	3/8	Hex	1/8	N/A	0.15	Bulk
15041	3/16" Solid Punch, 150 Line	0 45256 15041 3	5	3/8	Hex	3/16	N/A	0.15	Bulk
15060	1/16" Pin Punch, 150 Line	0 45256 15060 4	4	1/4	Hex	1/16	N/A	0.05	Bulk
15061	3/32" Pin Punch, 150 Line	0 45256 15061 1	4-1/2	5/16	Hex	3/32	N/A	0.08	Bulk
15062	1/8" Pin Punch, 150 Line	0 45256 15062 8	4-3/4	5/16	Hex	1/8	N/A	0.05	Bulk
15063	5/32" Pin Punch, 150 Line	0 45256 15063 5	5	5/16	Hex	5/32	N/A	0.10	Bulk
15064	3/16" Pin Punch, 150 Line	0 45256 15064 2	5-1/4	3/8	Hex	3/16	N/A	0.16	Bulk
15065	1/4" Pin Punch, 150 Line	0 45256 15065 9	5-3/4	3/8	Hex	1/4	N/A	0.17	Bulk
15081	1/8" Long Pin Punch, 150 Line	0 45256 15081 9	7-7/8	5/16	Hex	1/8	Extra Long	0.12	Bulk
15082	3/16" Long Pin Punch, 150 Line	0 45256 15082 6	7-7/8	3/8	Hex	3/16	Extra Long	0.16	Bulk
15083	1/4" Long Pin Punch, 150 Line	0 45256 15083 3	7-7/8	3/8	Hex	1/4	Extra Long	0.19	Bulk
15084	5/16" Long Pin Punch, 150 Line	0 45256 15084 0	7-7/8	7/16	Hex	5/16	Extra Long	0.28	Bulk

150 Line Set

Item	Description	UPC Code	OAL	Body Size	Body Type	Blade Width	Blade Style	Weight (Lbs)	Pkg. Type
15070	150 Line – 14 Pc Punch & Chisel Set	0 45256 15070 3	0	0	Hex	0	N/A	3.16	Leather



Mayhew Steel Products, Inc.
199 Industrial Blvd.
Turners Falls, MA 01376

U.S. Toll-Free Customer Service: 800-872-0037
Visit us online at www.Mayhew.com
Always wear safety goggles when using hand tools.

Version 2.2016
For the latest version, visit us
online at www.Mayhew.com

The Pros Know

Dominator

Pry Bars

Scrapers

Chisels

Punches

Steel Sets/
Kits

Specialty &
Extractors

Retail
Displays

Brass Sets/
Kits

150

Hard Cap

Hollow Punch
Sets

Automotive/
Specialty

Pneumatic

35



- Impact disc efficiently transfers blow
- Reinforced polymer by DuPont reduces noise by up to 80%
- Cap-and-cushion grip reduces the amount of shock by up to 90%
- Striking surface enlarged by 2 1/2 times
- Eliminates flying metal fragments
- Reduces glancing blows
- Reduces hammer kickback and trauma to wrist and elbow

Hard Cap Chisels

Item	Description	UPC Code	OAL	Body Size	Body Type	Blade Width	Blade Style	Weight (Lbs)	Pkg. Type
66104	1/2" X 7" Hard Cap Cold Chisel	0 81243 66104 3	7	3/8	Hex	1/2	N/A	0.33	Blister Pack
66106	3/4" X 8" Hard Cap Cold Chisel	0 81243 66106 7	8	5/8	Hex	3/4	N/A	0.83	Blister Pack
66107	7/8" X 8.5" Hard Cap Cold Chisel	0 81243 66107 4	8-1/2	5/8	Hex	7/8	N/A	1.01	Blister Pack
66122	3/4" X 11" Hard Cap Cold Chisel	0 81243 66122 7	11	5/8	Hex	3/4	N/A	1.12	Blister Pack
66124	1" X 11" Hard Cap Cold Chisel	0 81243 66124 1	11	3/4	Hex	1	N/A	1.58	Blister Pack



Hard Cap Punches

Item	Description	UPC Code	OAL	Body Size	Body Type	Blade Width	Blade Style	Weight (Lbs)	Pkg. Type
66401	1/8" X 7" Hard Cap Star Punch	0 81243 66401 3	7	3/8	Hex	1/8	N/A	0.29	Clamshell
66412	7/32" X 7" Hard Cap Center Punch	0 81243 66412 9	7	3/8	Hex	7/32	N/A	0.31	Clamshell
66414	1/4" X 7" Hard Cap Center Punch	0 81243 66414 3	7	7/16	Hex	1/4	N/A	0.38	Clamshell
66422	1/8" X 7" Hard Cap Pin Punch	0 81243 66422 8	7	5/8	Hex	1/8	N/A	0.27	Clamshell
66423	5/32" X 7" Hard Cap Pin Punch	0 81243 66423 5	7	3/8	Hex	5/32	N/A	0.27	Clamshell
66424	3/16" X 7" Hard Cap Pin Punch	0 81243 66424 2	7	3/8	Hex	3/16	N/A	0.28	Clamshell
66427	1/4" X 7" Hard Cap Pin Punch	0 81243 66427 3	7	7/16	Hex	1/4	N/A	0.35	Clamshell
66435	7/32" X 7" Hard Cap Prick Punch	0 81243 66435 8	7	3/8	Hex	7/32	N/A	0.29	Clamshell
66440	3/16" X 9" Hard Cap Aligning Punch	0 81243 66440 2	9	3/8	Hex	3/16	N/A	0.35	Clamshell
66441	1/4" X 10" Hard Cap Aligning Punch	0 81243 66441 9	10	7/16	Hex	1/4	N/A	0.51	Clamshell
66442	5/16" X 11" Hard Cap Aligning Punch	0 81243 66442 6	11	5/8	Hex	5/16	N/A	1.04	Clamshell

Hard Cap Sets

Item	Description	UPC Code	OAL	Body Size	Body Type	Blade Width	Blade Style	Weight (Lbs)	Pkg. Type
66900	4 Pc Hard Cap Cold Chisel Set	0 81243 66900 1	0	0	Hex	0	N/A	3.20	Pouch
66475	3 Pc Hard Cap Nail Set	0 81243 66475 4	0	0	Round	0	N/A	1.00	Carded
66901	4 Pc Hard Cap Pin Punch Set	0 81243 66901 8	0	0	Hex	0	N/A	1.09	Pouch
66902	4 Pc Hard Cap Punch Set	0 81243 66902 5	0	0	Hex	0	N/A	1.19	Pouch
66907	3 Pc Hard Cap Alignment Punch Set	0 81243 66907 0	0	0	Hex	0	N/A	1.87	Pouch



66900 – 4 Pc Hard Cap Cold Chisel Set



66475 – 3 Pc Hard Cap Nail Set



66901 – 4 Pc Hard Cap Pin Punch Set



66902 – 4 Pc Hard Cap Punch Set



66907 – 3 Pc Hard Cap Alignment Punch Set

Dominator
Pry Bars
Scrapers
Chisels
Punches
Steel Sets/
Kits
Specialty &
Extractors
Retail
Displays
Brass Sets/
Kits
150
Hard Cap
Hollow Punch
Sets
Automotive/
Specialty
Pneumatic
36

Hollow Punch Sets

Item	Description	UPC Code	OAL	Body Size	Body Type	Blade Width	Blade Style	Weight (Lbs)	Pkg. Type
66004	16 Pc Hollow Punch Set (Metric) 50500 – Handle for 16 Pc Hollow Punch Kit 50551 – 3mm Hollow Punch 50552 – 4mm Hollow Punch 50554 – 6mm Hollow Punch 50556 – 8mm Hollow Punch 50558 – 10mm Hollow Punch 50559 – 12mm Hollow Punch 50560 – 14mm Hollow Punch 50561 – 16mm Hollow Punch 50562 – 18mm Hollow Punch 50563 – 20mm Hollow Punch 50564 – 22mm Hollow Punch 50565 – 24mm Hollow Punch 50566 – 26mm Hollow Punch 50567 – 28mm Hollow Punch 50568 – 30mm Hollow Punch	0 45256 66004 2	N/A	N/A	N/A	N/A	N/A	2.47	Plastic Case
66006	31 Pc Hollow Punch Set (Metric) 50530 – Handle for 27 & 36 Pc Hollow Punch Kit 50540 – Mandril for 27 Pc Hollow Punch Kit 50550 – 2mm Hollow Punch 50551 – 3mm Hollow Punch 50552 – 4mm Hollow Punch 50553 – 5mm Hollow Punch 50554 – 6mm Hollow Punch 50555 – 7mm Hollow Punch 50556 – 8mm Hollow Punch 50557 – 9mm Hollow Punch 50558 – 10mm Hollow Punch 50559 – 12mm Hollow Punch 50560 – 14mm Hollow Punch 50561 – 16mm Hollow Punch 50562 – 18mm Hollow Punch 50563 – 20mm Hollow Punch 50564 – 22mm Hollow Punch 50565 – 24mm Hollow Punch 50566 – 26mm Hollow Punch 50567 – 28mm Hollow Punch 50568 – 30mm Hollow Punch 50569 – 32mm Hollow Punch 50570 – 34mm Hollow Punch 50571 – 36mm Hollow Punch 50572 – 38mm Hollow Punch 50573 – 40mm Hollow Punch 50574 – 42mm Hollow Punch 50575 – 44mm Hollow Punch 50576 – 46mm Hollow Punch 50577 – 48mm Hollow Punch 50578 – 50mm Hollow Punch	0 45256 66006 6	N/A	N/A	N/A	N/A	N/A	6.06	Plastic Case
 <p>66006 – 31 Pc Hollow Punch Set (Metric)</p>									
66010	11 Pc Hollow Punch Set (Metric) 50490 – Handle for 11 Pc Hollow Punch Kit 50551 – 3mm Hollow Punch 50552 – 4mm Hollow Punch 50554 – 6mm Hollow Punch 50556 – 8mm Hollow Punch 50558 – 10mm Hollow Punch 50559 – 12mm Hollow Punch 50560 – 14mm Hollow Punch 50561 – 16mm Hollow Punch 50562 – 18mm Hollow Punch 50563 – 20mm Hollow Punch	0 45256 66010 3	N/A	N/A	N/A	N/A	N/A	1.32	Plastic Case
50580	2 Pc Conversion Handle Set	0 45256 50580 0	N/A	N/A	N/A	N/A	N/A	1.40	Plastic Bag

Dominator
 Pry Bars
 Scrapers
 Chisels
 Punches
 Steel Sets/
 Kits
 Specialty &
 Extractors
 Retail
 Displays
 Brass Sets/
 Kits
 150
 Hard Cap
**Hollow Punch
 Sets**
 Automotive/
 Specialty
 Pneumatic



Mayhew Steel Products, Inc.
199 Industrial Blvd.
Turners Falls, MA 01376

U.S. Toll-Free Customer Service: 800-872-0037
Visit us online at www.Mayhew.com
Always wear safety goggles when using hand tools.

Version 2.2016
For the latest version, visit us
online at www.Mayhew.com

Hollow Punch Sets – Cont.

Dominator
 Pry Bars
 Scrapers
 Chisels
 Punches
 Steel Sets/
 Kits
 Specialty &
 Extractors
 Retail
 Displays
 Brass Sets/
 Kits
 150
 Hard Cap
 Hollow Punch
 Sets
 Automotive/
 Specialty
 Pneumatic
 38

Item	Description	UPC Code	OAL	Body Size	Body Type	Blade Width	Blade Style	Weight (Lbs)	Pkg. Type
66002	27 Pc Hollow Punch Set (SAE) 50501 – 1/8" Hollow Punch 50502 – 3/16" Hollow Punch 50503 – 1/4" Hollow Punch 50504 – 5/16" Hollow Punch 50505 – 3/8" Hollow Punch 50506 – 7/16" Hollow Punch 50507 – 1/2" Hollow Punch 50508 – 9/16" Hollow Punch 50509 – 5/8" Hollow Punch 50510 – 3/4" Hollow Punch 50511 – 7/8" Hollow Punch 50512 – 1" Hollow Punch 50513 – 1-1/16" Hollow Punch 50514 – 1-1/8" Hollow Punch 50515 – 1-3/16" Hollow Punch 50516 – 1-1/4" Hollow Punch 50517 – 1-5/16" Hollow Punch 50518 – 1-3/8" Hollow Punch 50519 – 1-7/16" Hollow Punch 50520 – 1-1/2" Hollow Punch 50521 – 1-5/8" Hollow Punch 50522 – 1-11/16" Hollow Punch 50523 – 1-3/4" Hollow Punch 50524 – 1-7/8" Hollow Punch 50525 – 2" Hollow Punch 50530 – Handle for 27 & 36 Pc Hollow Punch Kit 50540 – Mandril for 27 Pc Hollow Punch Kit	0 45256 66002 8	N/A	N/A	N/A	N/A	N/A	5.74	Plastic Case
66000	16 Pc Hollow Punch Set (SAE) 50500 – Handle 50501 – 1/8" Hollow Punch 50502 – 3/16" Hollow Punch 50503 – 1/4" Hollow Punch 50504 – 5/16" Hollow Punch 50505 – 3/8" Hollow Punch 50506 – 7/16" Hollow Punch 50507 – 1/2" Hollow Punch 50508 – 9/16" Hollow Punch 50509 – 5/8" Hollow Punch 50510 – 3/4" Hollow Punch 50511 – 7/8" Hollow Punch 50512 – 1" Hollow Punch 50513 – 1-1/16" Hollow Punch 50514 – 1-1/8" Hollow Punch 50515 – 1-3/16" Hollow Punch	0 45256 66000 4	N/A	N/A	N/A	N/A	N/A	2.42	Plastic Case
<p>66000 – 16 Pc Hollow Punch Set (SAE)</p>									
66008	11 Pc Hollow Punch Set (SAE) 50490 – Handle for 11 Pc Hollow Punch Kit 50501 – 1/8" Hollow Punch 50502 – 3/16" Hollow Punch 50503 – 1/4" Hollow Punch 50504 – 5/16" Hollow Punch 50505 – 3/8" Hollow Punch 50506 – 7/16" Hollow Punch 50507 – 1/2" Hollow Punch 50508 – 9/16" Hollow Punch 50509 – 5/8" Hollow Punch 50510 – 3/4" Hollow Punch	0 45256 66008 0	N/A	N/A	N/A	N/A	N/A	1.32	Plastic Case
66012	10 Pc Hollow Punch Set (SAE) 50500 – Handle 50501 – 1/8" Hollow Punch 50502 – 3/16" Hollow Punch 50503 – 1/4" Hollow Punch 50504 – 5/16" Hollow Punch 50505 – 3/8" Hollow Punch 50526 – 5/32" Hollow Punch 50527 – 7/32" Hollow Punch 50528 – 9/32" Hollow Punch 50529 – 11/32" Hollow Punch	0 45256 66012 7	N/A	N/A	N/A	N/A	N/A	0.62	Plastic Case

Hollow Punch Sets – Cont.

Item	Description	UPC Code	OAL	Body Size	Body Type	Blade Width	Blade Style	Weight (Lbs)	Pkg. Type
66016	36 Pc Hollow Punch Set (SAE) 50501 – 1/8" Hollow Punch 50502 – 3/16" Hollow Punch 50503 – 1/4" Hollow Punch 50504 – 5/16" Hollow Punch 50505 – 3/8" Hollow Punch 50506 – 7/16" Hollow Punch 50507 – 1/2" Hollow Punch 50508 – 9/16" Hollow Punch 50509 – 5/8" Hollow Punch 50510 – 3/4" Hollow Punch 50511 – 7/8" Hollow Punch 50512 – 1" Hollow Punch 50513 – 1-1/16" Hollow Punch 50514 – 1-1/8" Hollow Punch 50515 – 1-3/16" Hollow Punch 50516 – 1-1/4" Hollow Punch 50517 – 1-5/16" Hollow Punch 50518 – 1-3/8" Hollow Punch 50519 – 1-7/16" Hollow Punch 50520 – 1-1/2" Hollow Punch 50521 – 1-5/8" Hollow Punch 50522 – 1-11/16" Hollow Punch 50523 – 1-3/4" Hollow Punch 50524 – 1-7/8" Hollow Punch 50525 – 2" Hollow Punch 50526 – 5/32" Hollow Punch 50527 – 7/32" Hollow Punch 50528 – 9/32" Hollow Punch 50529 – 11/32" Hollow Punch 50530 – Handle for 27 & 36 Pc Hollow Punch Kit 50539 – Mandril for 36 Pc Hollow Punch Kit 50541 – 2-1/8" Hollow Punch 50542 – 2-3/16" Hollow Punch 50543 – 2-1/4" Hollow Punch 50544 – 2-5/16" Hollow Punch 50546 – 2-3/8" Hollow Punch	0 45256 66016 5	N/A	N/A	N/A	N/A	N/A	11.47	Plastic Case
66080	28 Pc Hollow Punch Set (SAE) 50501 – 1/8" Hollow Punch 50502 – 3/16" Hollow Punch 50503 – 1/4" Hollow Punch 50504 – 5/16" Hollow Punch 50505 – 3/8" Hollow Punch 50506 – 7/16" Hollow Punch 50507 – 1/2" Hollow Punch 50508 – 9/16" Hollow Punch 50509 – 5/8" Hollow Punch 50510 – 3/4" Hollow Punch 50511 – 7/8" Hollow Punch 50512 – 1" Hollow Punch 50513 – 1-1/16" Hollow Punch 50514 – 1-1/8" Hollow Punch 50515 – 1-3/16" Hollow Punch 50516 – 1-1/4" Hollow Punch 50517 – 1-5/16" Hollow Punch 50518 – 1-3/8" Hollow Punch 50519 – 1-7/16" Hollow Punch 50520 – 1-1/2" Hollow Punch 50521 – 1-5/8" Hollow Punch 50522 – 1-11/16" Hollow Punch 50523 – 1-3/4" Hollow Punch 50524 – 1-7/8" Hollow Punch 50525 – 2" Hollow Punch 50580 – 2 Pc Conversion Handle Set	0 45256 66080 6	N/A	N/A	N/A	N/A	N/A	5.8	Plastic Case



66080 – 28 Pc Hollow Punch Set (SAE)

Dominator
Pry Bars
Scrapers
Chisels
Punches
Steel Sets/ Kits
Specialty & Extractors
Retail Displays
Brass Sets/ Kits
150
Hard Cap
Hollow Punch Sets
Automotive/ Specialty
Pneumatic
39



Mayhew Steel Products, Inc.
199 Industrial Blvd.
Turners Falls, MA 01376

U.S. Toll-Free Customer Service: 800-872-0037
Visit us online at www.Mayhew.com
Always wear safety goggles when using hand tools.

Version 2.2016
For the latest version, visit us
online at www.Mayhew.com

The Pros Know



- Used to create precise gaskets and washers in softer materials, e.g., cloth, vinyl, leather, light sheet metal, and gasket material
- Wide array of sizes available for numerous ID and OD configurations
- Available in kits or sold individually; various mandrels and handles available to use with striking tools
- Dual cutting heads allow the user to punch concentric circles in one strike
- Made in France

Hollow Punches (Metric)

Item	Description	UPC Code	OAL	Body Size	Body Type	Blade Width	Blade Style	Weight (Lbs)	Pkg. Type
50550	2mm Hollow Punch	0 45256 50550 3	0	0	N/A	2mm	N/A	0.02	Plastic Bag
50551	3mm Hollow Punch	0 45256 50551 0	0	0	N/A	3mm	N/A	0.02	Plastic Bag
50552	4mm Hollow Punch	0 45256 50552 7	0	0	N/A	4mm	N/A	0.02	Plastic Bag
50553	5mm Hollow Punch	0 45256 50553 4	0	0	N/A	5mm	N/A	0.02	Plastic Bag
50554	6mm Hollow Punch	0 45256 50554 1	0	0	N/A	6mm	N/A	0.02	Plastic Bag
50555	7mm Hollow Punch	0 45256 50555 8	0	0	N/A	7mm	N/A	0.02	Plastic Bag
50556	8mm Hollow Punch	0 45256 50556 5	0	0	N/A	8mm	N/A	0.02	Plastic Bag
50557	9mm Hollow Punch	0 45256 50557 2	0	0	N/A	9mm	N/A	0.02	Plastic Bag
50558	10mm Hollow Punch	0 45256 50558 9	0	0	N/A	10mm	N/A	0.02	Plastic Bag
50559	12mm Hollow Punch	0 45256 50559 6	0	0	N/A	12mm	N/A	0.05	Plastic Bag
50560	14mm Hollow Punch	0 45256 50560 2	0	0	N/A	14mm	N/A	0.05	Plastic Bag
50561	16mm Hollow Punch	0 45256 50561 9	0	0	N/A	16mm	N/A	0.05	Plastic Bag
50562	18mm Hollow Punch	0 45256 50562 6	0	0	N/A	18mm	N/A	0.05	Plastic Bag
50563	20mm Hollow Punch	0 45256 50563 3	0	0	N/A	20mm	N/A	0.09	Plastic Bag
50564	22mm Hollow Punch	0 45256 50564 0	0	0	N/A	22mm	N/A	0.09	Plastic Bag
50565	24mm Hollow Punch	0 45256 50565 7	0	0	N/A	24mm	N/A	0.09	Plastic Bag
50566	26mm Hollow Punch	0 45256 50566 4	0	0	N/A	26mm	N/A	0.09	Plastic Bag
50567	28mm Hollow Punch	0 45256 50567 1	0	0	N/A	28mm	N/A	0.09	Plastic Bag
50568	30mm Hollow Punch	0 45256 50568 8	0	0	N/A	30mm	N/A	0.09	Plastic Bag
50569	32mm Hollow Punch	0 45256 50569 5	0	0	N/A	32mm	N/A	0.15	Plastic Bag
50570	34mm Hollow Punch	0 45256 50570 1	0	0	N/A	34mm	N/A	0.15	Plastic Bag
50571	36mm Hollow Punch	0 45256 50571 8	0	0	N/A	36mm	N/A	0.15	Plastic Bag
50572	38mm Hollow Punch	0 45256 50572 5	0	0	N/A	38mm	N/A	0.15	Plastic Bag
50573	40mm Hollow Punch	0 45256 50573 2	0	0	N/A	40mm	N/A	0.15	Plastic Bag
50574	42mm Hollow Punch	0 45256 50574 9	0	0	N/A	42mm	N/A	0.23	Plastic Bag
50575	44mm Hollow Punch	0 45256 50575 6	0	0	N/A	44mm	N/A	0.23	Plastic Bag
50576	46mm Hollow Punch	0 45256 50576 3	0	0	N/A	46mm	N/A	0.23	Plastic Bag
50577	48mm Hollow Punch	0 45256 50577 0	0	0	N/A	48mm	N/A	0.23	Plastic Bag
50578	50mm Hollow Punch	0 45256 50578 7	0	0	N/A	50mm	N/A	0.23	Plastic Bag
50579	51mm Hollow Punch	0 45256 50579 4	0	0	N/A	51mm	N/A	0.23	Plastic Bag



Hollow Punch Handles

Item	Description	UPC Code	OAL	Body Size	Body Type	Blade Width	Blade Style	Weight (Lbs)	Pkg. Type
50490	Handle for 11 Pc Hollow Punch Kit	0 45256 50490 2	4	1-1/2	N/A	0	N/A	0.76	Plastic Bag
50500	Handle for 16 Pc Hollow Punch Kit	0 45256 50500 8	5	1-1/2	N/A	0	N/A	1.04	Plastic Bag
50530	Handle for 27 & 36 Pc Hollow Punch Kit	0 45256 50530 5	0	0	N/A	0	N/A	1.14	Plastic Bag
50539	Mandril for 36 Pc Hollow Punch Kit	0 45256 50539 8	0	0	N/A	0	N/A	1.25	Plastic Bag
50540	Mandril for 27 Pc Hollow Punch Kit	0 45256 50540 4	0	0	N/A	0	N/A	0.78	Plastic Bag
50545	2 Pc Handle & Mandril for 27 Pc Kit	0 45256 50545 9	5	0	N/A	0	N/A	1.04	Plastic Bag
50580	2 Pc Pistol Grip Conversion Handle Set	0 45256 50580 0	N/A	N/A	N/A	N/A	N/A	1.40	Plastic Bag

Dominator
Pry Bars
Scrapers
Chisels
Punches
Steel Sets/
Kits
Specialty &
Extractors
Retail
Displays
Brass Sets/
Kits
150
Hard Cap
Hollow Punch
Sets
Automotive/
Specialty
Pneumatic
40



- Used to create precise gaskets and washers in softer materials; e.g. cloth, vinyl, leather, light sheet metal, and gasket material
- Wide array of sizes available for numerous ID and OD configurations
- Available in kits or sold individually; various mandrels and handles available to use with striking tools
- Dual cutting heads allow the user to punch concentric circles in one strike
- Made in France

Hollow Punches (Imperial)

Item	Description	UPC Code	OAL	Body Size	Body Type	Blade Width	Blade Style	Weight (Lbs)	Pkg. Type
50501	1/8" Hollow Punch	0 45256 50501 5	0	0	N/A	1/8	N/A	0.02	Plastic Bag
50502	3/16" Hollow Punch	0 45256 50502 2	0	0	N/A	3/16	N/A	0.02	Plastic Bag
50503	1/4" Hollow Punch	0 45256 50503 9	0	0	N/A	1/4	N/A	0.02	Plastic Bag
50504	5/16" Hollow Punch	0 45256 50504 6	0	0	N/A	5/16	N/A	0.02	Plastic Bag
50505	3/8" Hollow Punch	0 45256 50505 3	0	0	N/A	3/8	N/A	0.02	Plastic Bag
50506	7/16" Hollow Punch	0 45256 50506 0	0	0	N/A	7/16	N/A	0.05	Plastic Bag
50507	1/2" Hollow Punch	0 45256 50507 7	0	0	N/A	1/2	N/A	0.05	Plastic Bag
50508	9/16" Hollow Punch	0 45256 50508 4	0	0	N/A	9/16	N/A	0.05	Plastic Bag
50509	5/8" Hollow Punch	0 45256 50509 1	0	0	N/A	5/8	N/A	0.05	Plastic Bag
50510	3/4" Hollow Punch	0 45256 50510 7	0	0	N/A	3/4	N/A	0.05	Plastic Bag
50511	7/8" Hollow Punch	0 45256 50511 4	0	0	N/A	7/8	N/A	0.08	Plastic Bag
50512	1" Hollow Punch	0 45256 50512 1	0	0	N/A	1	N/A	0.08	Plastic Bag
50513	1-1/16" Hollow Punch	0 45256 50513 8	0	0	N/A	1-1/16	N/A	0.08	Plastic Bag
50514	1-1/8" Hollow Punch	0 45256 50514 5	0	0	N/A	1-1/8	N/A	0.08	Plastic Bag
50515	1-3/16" Hollow Punch	0 45256 50515 2	0	0	N/A	1-3/16	N/A	0.08	Plastic Bag
50516	1-1/4" Hollow Punch	0 45256 50516 9	0	0	N/A	1-1/4	N/A	0.16	Plastic Bag
50517	1-5/16" Hollow Punch	0 45256 50517 6	0	0	N/A	1-5/16	N/A	0.16	Plastic Bag
50518	1-3/8" Hollow Punch	0 45256 50518 3	0	0	N/A	1-3/8	N/A	0.16	Plastic Bag
50519	1-7/16" Hollow Punch	0 45256 50519 0	0	0	N/A	1-7/16	N/A	0.16	Plastic Bag
50520	1-1/2" Hollow Punch	0 45256 50520 6	0	0	N/A	1-1/2	N/A	0.16	Plastic Bag
50521	1-5/8" Hollow Punch	0 45256 50521 3	0	0	N/A	1-5/8	N/A	0.22	Plastic Bag
50522	1-11/16" Hollow Punch	0 45256 50522 0	0	0	N/A	1-11/16	N/A	0.22	Plastic Bag
50523	1-3/4" Hollow Punch	0 45256 50523 7	0	0	N/A	1-3/4	N/A	0.22	Plastic Bag
50524	1-7/8" Hollow Punch	0 45256 50524 4	0	0	N/A	1-7/8	N/A	0.22	Plastic Bag
50525	2" Hollow Punch	0 45256 50525 1	0	0	N/A	2	N/A	0.22	Plastic Bag
50526	5/32" Hollow Punch	0 45256 50526 8	0	0	N/A	5/32	N/A	0.02	Plastic Bag
50527	7/32" Hollow Punch	0 45256 50527 5	0	0	N/A	7/32	N/A	0.02	Plastic Bag
50528	9/32" Hollow Punch	0 45256 50528 2	0	0	N/A	9/32	N/A	0.02	Plastic Bag
50529	11/32" Hollow Punch	0 45256 50529 9	0	0	N/A	11/32	N/A	0.02	Plastic Bag
50541	2-1/8" Hollow Punch	0 45256 50541 1	0	0	N/A	2-1/8	N/A	0.32	Plastic Bag
50542	2-3/16" Hollow Punch	0 45256 50542 8	0	0	N/A	2-3/16	N/A	0.29	Plastic Bag
50543	2-1/4" Hollow Punch	0 45256 50543 5	0	0	N/A	2-1/4	N/A	0.29	Plastic Bag
50544	2 5/16" Hollow Punch	0 45256 50544 2	0	0	N/A	2-5/16	N/A	0.29	Plastic Bag
50546	2-3/8" Hollow Punch	0 45256 50546 6	0	0	N/A	2-3/8	N/A	0.29	Plastic Bag

Dominator
 Pry Bars
 Scrapers
 Chisels
 Punches
 Steel Sets/
 Kits
 Specialty &
 Extractors
 Retail
 Displays
 Brass Sets/
 Kits
 150
 Hard Cap
 Hollow Punch
 Sets
 Automotive/
 Specialty
 Pneumatic
 41



Mayhew Steel Products, Inc.
 199 Industrial Blvd.
 Turners Falls, MA 01376

U.S. Toll-Free Customer Service: 800-872-0037
 Visit us online at www.Mayhew.com
 Always wear safety goggles when using hand tools.

Version 2.2016
 For the latest version, visit us
 online at www.Mayhew.com

The Pros Know



31000 – 4 Pc Upholstery Clip Set

Automotive

Item	Description	UPC Code	OAL	Body Size	Body Type	Blade Width	Blade Style	Weight (Lbs)	Pkg. Type
31000	4 Pc Upholstery Clip Set 31001 – Upholstery Clip Remover 31002 – Upholstery Clip Remover 31008 – Mini Upholstery Clip Remover 31009 – Mini Upholstery Clip Remover	0 45256 31000 8	N/A	N/A	Square	N/A	N/A	1.12	Bulk



Upholstery Clip Remover

- Used to remove upholstery clips
- Acetate handle for a more secure grip
- Made in the USA

Item	Description	UPC Code	OAL	Body Size	Body Type	Blade Width	Blade Style	Weight (Lbs)	Pkg. Type
31001	Upholstery Clip Remover	0 45256 31001 5	9-9/16	5/16	Square	7/8	N/A	0.96	Bulk
31002	Upholstery Clip Remover	0 45256 31002 2	9-9/16	5/16	Square	1	N/A	0.96	Bulk
31008	Mini Upholstery Clip Remover	0 45256 31008 4	9-3/8	3/16	Round	1/24	N/A	0.65	Bulk
31009	Mini Upholstery Clip Remover	0 45256 31009 1	9-3/8	3/16	Round	1/24	N/A	0.65	Bulk

Hose Clamp Pliers

- Used to loosen and remove a wide variety of automotive hose clamps

Item	Description	UPC Code	OAL	Weight (Lbs)	Pkg. Type
28690	Rigiflex™ Hose Clamp Pliers	0 45256 28690 7	15-1/8	1.72	Box
28691	Rigiflex™ Replacement Kit	0 45256 28691 4	17-1/2	1.72	Plastic Bag
28680	Professional Hose Clamp Pliers	0 45256 28680 8	14-1/2	1.02	Bulk
28682	Replacement Cable	0 45256 28682 2	N/A	0.07	Plastic Bag
45680	Hose Clamp Pliers	0 45256 45680 5	N/A	0.25	Plastic Bag
28657	Hose Clamp Pliers, Easy Access	0 45256 28657 0	14-1/2	0.88	Clamshell
28658	Replacement Jaws for Easy-Access Hose Clamp Pliers	0 45256 28658 7	N/A	0.04	Plastic Bag
28665	Clic Hose Clamp Pliers	0 45256 28665 5	7	0.50	Clamshell
28655	Hose Clamp Pliers, 2 Pc Set 28650 – Cable Op/Ratcheting Hose Clamp Pliers 28657 – Hose Clamp Plier, Easy Access	0 45256 28655 1	N/A	0.04	Bulk



Made in France *Exclusive USA Distributor



- Patent Pending
- Used to remove and mount inner tie rods on vehicles
- Fits 35-45mm tie rods with no additional interchangeable adapters
- For use on round, hexagonal, and octagonal tie rods
- Extended shaft and narrow profile allows for use in hard-to-reach and confined spaces
- Made in France

Tie Rod Tools

Item	Description	UPC Code	OAL	Body Size	Body Type	Blade Width	Blade Style	Weight (Lbs)	Pkg. Type
29910	Universal Inner Tie Rod Tool	0 45256 29910 5	16-1/2	N/A	Round	N/A	N/A	4.4	Bulk
29915	35-45mm Speedy Roller Cage	0 45256 29915 0	2	N/A	Round	N/A	N/A	0.25	Box
29916	28-38mm Speedy Roller Cage	0 45256 29916 7	2	N/A	Round	N/A	N/A	0.19	Box

Dominator
Pry Bars
Scrapers
Chisels
Punches
Steel Sets/
Kits
Specialty &
Extractors
Retail
Displays
Brass Sets/
Kits
150
Hard Cap
Hollow Punch
Sets
Automotive/
Specialty
Pneumatic
42

Professional Hose Clamp Pliers with Flexible Cable

28690 - Rigiflex Pliers

Replaces 28630

Flexes and holds to
any desired position



Multi-stop
Jaw-Piece
Lock



Easy to
replace cable



28680 - Hose Clamp Pliers

Replaces 28650

- Unique Jaw design fits clamps up to 2" (51mm)
- Extra-heavy duty 5/64" (2mm) cable
- Bi-material grips with snap feature
- Easy to replace cable



45680 - Hose Clamp Pliers

Replaces 45650

If you want to replace this, please ask for repair kit with complete instructions: 28682



Mayhew Steel Products, Inc.
199 Industrial Blvd.
Turners Falls, MA 01376

U.S. Toll-Free Customer Service: 800-872-0037
Visit us online at www.Mayhew.com
Always wear safety goggles when using hand tools.

Version 2.2016
For the latest version, visit us
online at www.Mayhew.com







The Pros Know

Dominator
Pry Bars
Scrapers
Chisels
Punches
Steel Sets/ Kits
Specialty & Extractors
Retail Displays
Brass Sets/ Kits
150
Hard Cap
Hollow Punch Sets
Automotive/ Specialty
Pneumatic
43

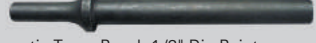

Pneumatic Punches, Chisels, & Hammers

- Used with a pneumatic tool
- Available in standard and heavy-duty shank sizes, in multiple sizes, and points
- Black oxide finish for additional rust protection
- Made in the USA

Item	Description	UPC Code	OAL	Body Size	Body Type	Blade Width	Blade Style	Weight (Lbs)	Pkg. Type
31970	 2" Pneumatic Chisel	0 45256 31970 4	8-1/2	0.401	Round	2	N/A	0.50	Bulk
81970	2" Pneumatic Chisel Carded	0 45256 81970 9	8-1/2	0.401	Round	2	N/A	0.50	Carded
31972	 6" Pneumatic Cold Chisel	0 45256 31972 8	6	0.401	Round	5/8	N/A	0.38	Bulk
31989	6" Pneumatic Cold Chisel .498	0 45256 31989 6	6	0.498	Round	3/16	N/A	0.57	Bulk
31973	8" Pneumatic Cold Chisel	0 45256 31973 5	8	0.401	Round	5/8	N/A	0.43	Bulk
81989	6" Pneumatic Cold Chisel, .498, Carded	0 45256 81989 1	6	0.498	Round	3/16	N/A	0.57	Carded
31974	10" Pneumatic Cold Chisel	0 45256 31974 2	10	0.401	Round	5/8	N/A	0.53	Bulk
31986	18" Pneumatic Cold Chisel	0 45256 31986 5	18	0.401	Round	5/8	N/A	0.95	Bulk
81972	6" Pneumatic Cold Chisel, Carded	0 45256 81972 3	6	0.401	Round	5/8	N/A	0.38	Carded
81973	8" Pneumatic Cold Chisel, Carded	0 45256 81973 0	8	0.401	Round	5/8	N/A	0.43	Carded
81974	10" Pneumatic Cold Chisel Carded	0 45256 81974 7	10	0.401	Round	5/8	N/A	0.53	Carded
81986	18" Pneumatic Cold Chisel, Carded	0 45256 81986 0	18	0.401	Round	5/8	N/A	0.95	Carded
31977	 6" Pneumatic Taper Punch Sharp Point	0 45256 31977 3	6-1/4	0.401	Round	0	N/A	0.31	Bulk
31978	18" Pneumatic Taper Punch Sharp Point	0 45256 31978 0	18	0.401	Round	0	N/A	0.94	Bulk
31979	 Pneumatic Taper Punch 3/8" Dia Point	0 45256 31979 7	6	0.401	Round	3/8	N/A	0.32	Bulk
31980	 Pneumatic Taper Punch 1/2" Dia Point	0 45256 31980 3	6	0.401	Round	1/2	N/A	0.32	Bulk
81977	6" Pneumatic Taper Punch Sharp Point, Carded	0 45256 81977 8	6-1/4	0.401	Round	0	N/A	0.31	Carded
31999	Pneumatic Taper Punch .498	0 45256 31999 5	7-1/2	0.498	Round	3/4	N/A	0.49	Bulk
32011	3/8"-18 Pneumatic Taper Punch	0 45256 32011 3	18	0.401	Round	3/8	N/A	0.96	Bulk
32012	1/8"-18 Pneumatic Taper Punch	0 45256 32012 0	18	0.401	Round	1/8	N/A	0.95	Bulk
31997	Pneumatic Taper Punch	0 45256 31997 1	6-1/2	0.401	Round	1/8	N/A	0.31	Bulk
81979	3/8 Dia Point Pneumatic Taper Punch, Carded	0 45256 81979 2	6	0.401	Round	3/8	N/A	0.32	Carded
81980	1/2 Dia Point Pneumatic Taper Punch, Carded	0 45256 81980 8	6	0.401	Round	1/2	N/A	0.32	Carded
81997	Pneumatic Taper Punch, Carded	0 45256 81997 6	6-1/2	0.401	Round	1/8	N/A	0.31	Carded
81999	Pneumatic Taper Punch .498, Carded	0 45256 81999 0	7-1/2	0.498	Round	3/4	N/A	0.49	Carded
82012	1/8 X 18 Pneumatic Taper Punch, Carded	0 45256 82012 5	18	0.401	Round	1/8	N/A	0.95	Carded
31981	 Pneumatic Hammer	0 45256 31981 0	3.5	0.401	Round	1	N/A	0.28	Bulk
31982	4" Pneumatic Hammer	0 45256 31982 7	4	0.401	Round	1	N/A	0.30	Bulk
31987	6" Pneumatic Hammer	0 45256 31987 2	6	0.401	Round	1	N/A	0.41	Bulk
31994	1-1/4" Pneumatic Hammer Dia .498	0 45256 31994 0	4	0.498	Round	1-1/4	N/A	0.48	Bulk
32005	1-1/4" X 4" Pneumatic Extra-Wide Hammer	0 45256 32005 2	4	0.401	Round	1-1/4	N/A	0.40	Bulk
81981	1 X 3.5" Pneumatic Hammer, Carded	0 45256 81981 5	4	0.401	Round	1	N/A	0.28	Carded
81982	4" Pneumatic Hammer, Carded	0 45256 81982 2	4	0.401	Round	1	N/A	0.30	Carded
81987	6" Pneumatic Hammer, Carded	0 45256 81987 7	6	0.401	Round	1	N/A	0.41	Carded
81994	1-1/4" Dia Pneumatic Hammer 498, Carded	0 45256 81994 5	4	0.498	Round	1-1/4	N/A	0.48	Carded
81975	Pneumatic Rivet/Bolt Cutter, Carded	0 45256 81975 4	6-1/4	0.401	Round	5/8	N/A	0.32	Carded

Pneumatic Retainer Chuck



Item	Description	UPC Code	OAL	Body Size	Body Type	Blade Width	Blade Style	Weight (Lbs)	Pkg. Type
32053	Pneumatic Retainer Chuck	0 45256 32053 3	2	N/A	N/A	N/A	N/A	0.15	Bulk



Pneumatic Scrapers











- Used with a pneumatic tool on applications such as gaskets, rust, paint, and surface retouching
- Available in a wide range of sizes and shapes for the perfect tool for the job
- Black oxide finish for additional rust protection
- Made in the USA

Item	Description	UPC Code	OAL	Body Size	Body Type	Blade Width	Blade Style	Weight (Lbs)	Pkg. Type
31976	Pneumatic Scraper	0 45256 31976 6	8	0.401	Round	1-1/8	N/A	0.42	Bulk
32010	Pneumatic Scraper 1 1/8" - 18"	0 45256 32010 6	18	0.401	Round	1-1/8	N/A	0.94	Bulk
81976	Pneumatic Scraper	0 45256 81976 1	8	0.401	Round	1-1/8	N/A	0.42	Carded
82010	Pneumatic Scraper 1-1/8" X 18"	0 45256 82010 1	18	0.401	Round	1-1/8	N/A	0.94	Carded



Automotive

- Used for body, chassis, and exhaust applications
- Available in standard .401 shank sizes and many different styles for any application
- Black oxide finish for additional rust protection
- Made in the USA

Item	Description	UPC Code	OAL	Body Size	Body Type	Blade Width	Blade Style	Weight (Lbs)	Pkg. Type
31955	 Pneumatic Body Ripper	0 45256 31955 1	6	0.401	Round	5/8	N/A	0.32	Bulk
31956	 Pneumatic Double-Cut Body Ripper	0 45256 31956 8	6	0.401	Round	7/8	N/A	0.31	Bulk
31957	 Pneumatic Panel Cutter	0 45256 31957 5	6	0.401	Round	3/4	N/A	0.31	Bulk
31958	 Pneumatic Slotted Panel Cutter	0 45256 31958 2	6	0.401	Round	3/4	N/A	0.3	Bulk
31959	 Pneumatic Sheet Metal Trimmer	0 45256 31959 9	6	0.401	Round	3/4	N/A	0.3	Bulk
31960	 Pneumatic Spot Weld Breaker	0 45256 31960 5	6	0.401	Round	3/4	N/A	0.31	Bulk
31961	 Pneumatic Radius Cutter	0 45256 31961 2	6-1/2	0.401	Round	21/32	N/A	0.31	Bulk
31965	 Pneumatic Muffler/Tailpipe Remover	0 45256 31965 0	8-1/4	0.401	Round	5/8	N/A	0.39	Bulk
31966	 Pneumatic Inside Muffler Cutter	0 45256 31966 7	8-1/4	0.401	Round	3/16	N/A	0.42	Bulk
31967	 Pneumatic Outside Muffler Cutter	0 45256 31967 4	8-1/4	0.401	Round	3/16	N/A	0.43	Bulk
31968	 Pneumatic Tailpipe Cutoff	0 45256 31968 1	7-1/2	0.401	Round	1-25/64	N/A	0.4	Bulk



Mayhew Steel Products, Inc.
199 Industrial Blvd.
Turners Falls, MA 01376

U.S. Toll-Free Customer Service: 800-872-0037
Visit us online at www.Mayhew.com
Always wear safety goggles when using hand tools.

Version 2.2016
For the latest version, visit us
online at www.Mayhew.com

The Pros Know

Dominator

Pry Bars

Scrapers

Chisels

Punches

Steel Sets/
Kits

Specialty &
Extractors

Retail
Displays

Brass Sets/
Kits

150

Hard Cap

Hollow Punch
Sets

Automotive/
Specialty





Pneumatic

45



Automotive

- Used for body, chassis, and exhaust applications
- Available in standard .401 shank sizes and many different styles for any application
- Black oxide finish for additional rust protection
- Made in the USA

Item	Description	UPC Code	OAL	Body Size	Body Type	Blade Width	Blade Style	Weight (Lbs)	Pkg. Type
31971	 Pneumatic Splitting Tool	0 45256 31971 1	8-1/4	0.401	Round	5/8	N/A	0.36	Bulk
31975	 Pneumatic Rivet/Bolt Cutter	0 45256 31975 9	6-1/4	0.401	Round	5/8	N/A	0.32	Bulk
31985	Pneumatic 18" Nut Splitting Tool	0 45256 31985 8	18	0.401	Round	3/4	N/A	0.94	Bulk
31988	Pneumatic Retainer Spring	0 45256 31988 9	2	0.401	N/A	0	N/A	0.12	Bulk
31991	 Pneumatic Control Arm Bushing Remover	0 45256 31991 9	6	0.401	Round	1-5/16	N/A	0.31	Bulk
31992	 Pneumatic Rivet/Bolt Cutter .498	0 45256 31992 6	7-1/2	0.498	Round	3/4	N/A	0.57	Bulk
31993	 Pneumatic Tie Rod Sleeve Breaker	0 45256 31993 3	4	0.401	Round	1	N/A	0.29	Bulk
31995	Pneumatic Tie Rod Separator	0 45256 31995 7	7-1/2	0.401	Round	1-9/16	N/A	0.67	Bulk
31996	 Pneumatic Ball Joint Separator	0 45256 31996 4	7-1/2	0.401	Round	1-13/16	N/A	0.72	Bulk
32006	 Pneumatic Valve Guide Remover/Installer	0 45256 32006 9	6	0.401	Round	5/16	N/A	0.28	Bulk
81955	Pneumatic Body Ripper, Carded	0 45256 81955 6	6	0.401	Round	11/16	N/A	0.32	Carded
81956	Pneumatic Double-Cut Body Ripper	0 45256 81956 3	6	0.401	Round	7/8	N/A	0.31	Carded
81957	Pneumatic Panel Cutter	0 45256 81957 0	6	0.401	Round	3/4	N/A	0.31	Carded
81958	Pneumatic Slotted Panel Cutter	0 45256 81958 7	6	0.401	Round	3/4	N/A	0.3	Carded
81959	Pneumatic Sheet Metal Cutter	0 45256 81959 4	6	0.401	Round	3/4	N/A	0.3	Carded
81960	Pneumatic Spot Weld Breaker	0 45256 81960 0	6	0.401	Round	3/4	N/A	0.31	Carded
81961	 Pneumatic Radius Cutter	0 45256 81961 7	6-1/2	0.401	Round	21/32	N/A	0.31	Carded
81968	Pneumatic Tailpipe Cutoff	0 45256 81968 6	7-1/2	0.401	Round	1-25/64	N/A	0.4	Carded
81992	Pneumatic Rivet/Bolt Cutter .498	0 45256 81992 1	7-1/2	0.498	Round	3/4	N/A	0.57	Carded
81993	Pneumatic Tie Rod Sleeve Breaker	0 45256 81993 8	4	0.401	Round	1	N/A	0.29	Carded
81996	Pneumatic Ball Joint Separator	0 45256 81996 9	7-1/2	0.401	Round	1-13/16	N/A	0.72	Carded
82006	Pneumatic Valve Guide Remover/Installer	0 45256 82006 4	6	0.401	Round	5/16	N/A	0.28	Carded



Shake 'n Break

- Attaches to air hammer to provide vibration while removing stubborn/frozen fasteners or torx bolts/nuts
- Other end of each Shake 'n Break has either a 1/2" or 3/8" square drive to be used with impact sockets
- Built-in hex (19mm-3/4") on shaft of tool to be used in conjunction with open-end wrench when loosening stubborn fastener
- Applications include bearing removal and GM caliper removal
- Made in the USA

Item	Description	UPC Code	OAL	Body Size	Body Type	Blade Width	Blade Style	Weight (Lbs)	Pkg. Type
37315	3/8" Shake 'n Break Torx Bolt Breaker	0 4525637315 7	5	0.401	Round	N/A	N/A	0.32	Bulk
37316	1/2" Shake 'n Break Torx Bolt Breaker	0 4525637316 4	5	0.401	Round	N/A	N/A	0.35	Bulk

Dominator
Pry Bars
Scrapers
Chisels
Punches
Steel Sets/
Kits
Specialty &
Extractors
Retail
Displays
Brass Sets/
Kits
150
Hard Cap
Hollow Punch
Sets
Automotive/
Specialty
Pneumatic
46



37323 – 3 Pc Long Pneumatic Tool Set



37322 – 9 Pc Pneumatic Tool Set



37394 – 18 Pc Pneumatic Display Block

Pneumatic Sets

Item	Description	UPC Code	OAL	Body Size	Body Type	Blade Width	Blade Style	Weight (Lbs)	Pkg. Type
37320	4 Pc Basic Pneumatic Set 31965 – Pneumatic Muffler/Tailpipe Remover 31971 – Pneumatic Splitting Tool 31972 – Pneumatic Cold Chisel 6" 31975 – Pneumatic Rivet/Bolt Cutter	0 45256 37320 1	N/A	N/A	N/A	N/A	N/A	1.48	Pouch
37322	9 Pc Pneumatic Tool Set 31955 – Pneumatic Body Ripper 31957 – Pneumatic Panel Cutter 31958 – Pneumatic Slotted Panel Cutter 31959 – Pneumatic Sheet Metal Trimmer 31965 – Pneumatic Muffler/Tailpipe Remover 31971 – Pneumatic Splitting Tool 31972 – Pneumatic Cold Chisel 6" 31975 – Pneumatic Rivet/Bolt Cutter 31997 – Pneumatic Taper Punch	0 45256 37322 5	N/A	N/A	N/A	N/A	N/A	3.08	Pouch
37323	3 Pc Long Pneumatic Tool Set 32010 – Pneumatic Scraper 1 1/8"-18" 32011 – Pneumatic Taper Punch 3/8"-18" 32012 – Pneumatic Taper Punch 1/8"-18"	0 45256 37323 2	N/A	N/A	N/A	N/A	N/A	3.16	Bulk
37394	18 Pc Pneumatic Display Block 31956 – Pneumatic Double-Cut Body Ripper 31958 – Pneumatic Slotted Panel Cutter 31959 – Pneumatic Sheet Metal Trimmer 31960 – Pneumatic Spot Weld Breaker 31965 – Pneumatic Muffler/Tailpipe Remover 31968 – Pneumatic Tailpipe Cutoff 31972 – Pneumatic Cold Chisel 6" 31973 – Pneumatic Cold Chisel 8" 31974 – Pneumatic Cold Chisel 10" 31975 – Pneumatic Rivet/Bolt Cutter 31976 – Pneumatic Scraper 31977 – Pneumatic 6in Taper Punch Sharp Point 31979 – Pneumatic Taper Punch 3/8" Dia Point 31980 – Pneumatic Taper Punch 1/2" Dia Point 31982 – Pneumatic 4" Hammer 31995 – Pneumatic Tie Rod Separator 31996 – Pneumatic Ball Joint Separator 31997 – Pneumatic Taper Punch	0 45256 37394 2	N/A	N/A	N/A	N/A	N/A	8.05	Plastic Case



Long Pneumatic Scrapers & Hammers

Item	Description	UPC Code	OAL	Body Size	Body Type	Blade Width	Blade Style	Weight (Lbs)	Pkg. Type
32001	12" Pneumatic Hammer	0 45256 32001 4	12	0.401	Round	N/A	N/A	0.76	Bulk
32002	18" Pneumatic Hammer	0 45256 32002 1	18	0.401	Round	N/A	N/A	1.08	Bulk
32003	24" Pneumatic Hammer	0 45256 32003 8	24	0.401	Round	N/A	N/A	1.40	Bulk
32016	2"x18" Pneumatic Scraper	0 45256 32016 8	18	0.401	Round	3/4	N/A	1.00	Bulk
32017	2"x18" Pneumatic Scraper	0 45256 32017 5	24	0.401	Round	2	N/A	1.82	Bulk



Mayhew Steel Products, Inc.
199 Industrial Blvd.
Turners Falls, MA 01376

U.S. Toll-Free Customer Service: 800-872-0037
Visit us online at www.Mayhew.com
Always wear safety goggles when using hand tools.

Version 2.2016
For the latest version, visit us
online at www.Mayhew.com

The Pros Know

Dominator
 Pry Bars
 Scrapers
 Chisels
 Punches
 Steel Sets/
 Kits
 Specialty &
 Extractors
 Retail
 Displays
 Brass Sets/
 Kits
 150
 Hard Cap
 Hollow Punch
 Sets
 Automotive/
 Specialty
 Pneumatic
 47

From the Seasoned Pros to the Regular Joes

Just because it's not what you do for a living doesn't mean you don't want professional quality tools. From the car enthusiasts who take repair as seriously as the professional to the home improvement folks with a new deck under way, the MayhewSelect series offers high-quality tools that allow you to perform mechanical and tradesman-specific work as well as the men and women who do it for a living. Backed by the same experience and insights that have made Mayhew the professionals' choice for more than 150 years, as well as a two-year quality warranty on every tool, MayhewSelect turns weekend projects into weekend passions.



MAYHEW SELECT™

Since 1856

Know What The Pros Know



Brick & Mason Chisels

- Used in a multitude of masonry applications, from brick to stone to concrete
- Allows for specific cuts, sizes, and scores. Different cutting-edge lengths provide the perfect sized tool for the perfect finished look
- Shot-blasted finish
- Made in the USA

Item	Description	UPC Code	OAL	Body Size	Body Type	Blade Width	Blade Style	Weight (Lbs)	Pkg. Type
12300	3" Mason Chisel	0 45256 12300 4	7-1/2	7/8	Hex	3	N/A	1.32	Bulk
12301	3-1/2" Mason Chisel	0 45256 12301 1	7-1/2	1	Hex	3-1/2	N/A	1.70	Bulk
12302	4" Mason Chisel	0 45256 12302 8	7-1/2	1	Hex	4	N/A	1.66	Bulk
30210	12" Mason Chisel	0 45256 30210 2	12	3/8	Square	1-1/8	N/A	0.66	Bulk
34502	1-1/8" X 12" Flat Utility Chisel	0 81243 34502 8	12	3/8	Hex	1-1/8	N/A	1.23	Carded
35002	3" X 7" Mason Chisel, Carded	0 81243 35002 2	7	7/8	Hex	3	N/A	1.32	Carded
35102	3-1/2" X 7-1/4" Mason Chisel	0 81243 35102 9	7-1/4	7/8	Hex	3-1/2	N/A	1.70	Carded
35202	4" X 7" Mason Chisel	0 81243 35202 6	7	7/8	Hex	4	N/A	1.66	Carded
30211	18" Mason Chisel	0 45256 30211 9	18	3/8	Square	1-1/8	N/A	1.51	Bulk
30200	1-3/4" Mason Chisel	0 45256 30200 3	7-1/2	1/2	Hex	1-3/4	N/A	0.66	Bulk
30202	2-1/4" Mason Chisel	0 45256 30202 7	7-1/2	5/8	Hex	2-1/4	N/A	0.70	Bulk
35602	1-3/4" X 7-1/2" Mason Chisel	0 81243 35602 4	7-1/2	3/4	Hex	1-3/4	N/A	0.66	Carded
35702	2-1/4" X 7-3/4" Mason Chisel	0 81243 35702 1	7-3/4	7/8	Hex	2-1/4	N/A	0.70	Carded
35802	2-3/4" X 7-1/2" Mason Chisel	0 81243 35802 8	7-1/2	7/8	Hex	2-3/4	N/A	1.33	Carded



Bull Point Chisel

- Used to break up and demolish concrete
- Used where an air chisel is impractical
- Shot-blasted finish
- Made in the USA

Item	Description	UPC Code	OAL	Body Size	Body Type	Blade Width	Blade Style	Weight (Lbs)	Pkg. Type
30100	3/4" X 12" Reg Bull Point	0 45256 30100 6	12	3/4	Hex	5/16	N/A	1.55	Bulk



Clapboard Chisel

- Used to remove siding for access to wall cavities and trimming wood; also used to pull tongue and groove materials together
- Extra-long handle allows better leverage when cutting and trimming wood
- Shot-blasted finish
- Made in the USA

Item	Description	UPC Code	OAL	Body Size	Body Type	Blade Width	Blade Style	Weight (Lbs)	Pkg. Type
12312	18" Clapboard Chisel 2" Cut	0 45256 12312 7	18	5/8	Hex	2	N/A	1.30	Bulk



Floor Chisel

- Used to cut and trim wood and to pull tongue and groove materials together
- Thin blade allows for access to tight spaces
- Shot-blasted finish
- Made in the USA

Item	Description	UPC Code	OAL	Body Size	Body Type	Blade Width	Blade Style	Weight (Lbs)	Pkg. Type
12310	2-1/2" Floor Chisel	0 45256 12310 3	10-1/2	5/8	Hex	2-1/2	N/A	0.92	Bulk
12311	3" Floor Chisel	0 45256 12311 0	11	3/4	Hex	3	N/A	1.38	Bulk
94202	3" X 12" Floor Chisel, Carded	0 81243 94202 9	12	3/4	Hex	3	N/A	1.38	Carded



Mayhew Steel Products, Inc.
199 Industrial Blvd.
Turners Falls, MA 01376

U.S. Toll-Free Customer Service: 800-872-0037
Visit us online at www.Mayhew.com
Always wear safety goggles when using hand tools.

Version 2.2016
For the latest version, visit us
online at www.Mayhew.com

The Pros Know

Chisels

Punches

Pry Bars

Handguarded

Specialty

Inspection

Sets and Kits



Cold Chisels

- Used to cut and shape metals softer than the cutting edge of the chisel
- Cutting edge angle designed to provide greater strength
- Not intended to be used on masonry materials
- Available in a variety of lengths and sizes to fit any application
- Shot-blasted finish
- Made in the USA

Item	Description	UPC Code	OAL	Body Size	Body Type	Blade Width	Blade Style	Weight (Lbs)	Pkg. Type
10102	1/4" X 4-1/2" Cold Chisel	0 81243 10102 0	4-1/2	1/4	Hex	1/4	N/A	0.07	Carded
10202	5/16" X 5" Cold Chisel	0 81243 10202 7	4-3/4	1/4	Hex	5/16	N/A	0.07	Carded
10302	3/8" X 5" Cold Chisel	0 81243 10302 4	5	5/16	Hex	3/8	N/A	0.12	Carded
10402	1/2" X 6" Cold Chisel	0 81243 10402 1	6	3/8	Hex	1/2	N/A	0.19	Carded
10502	5/8" X 6-1/2" Cold Chisel	0 81243 10502 8	6-1/2	7/16	Hex	5/8	N/A	0.30	Carded
10602	3/4" X 7" Cold Chisel	0 81243 10602 5	7	5/8	Hex	3/4	N/A	0.41	Carded
10702	7/8" X 7-1/2" Cold Chisel	0 81243 10702 2	7-1/2	5/8	Hex	7/8	N/A	0.67	Carded
10802	1" X 8" Cold Chisel	0 81243 10802 9	8	3/4	Hex	1	N/A	1.00	Carded
12002	1/2" X 12" Cold Chisel	0 81243 12002 1	12	7/16	Hex	1/2	N/A	0.55	Carded
12102	5/8" X 12" Cold Chisel	0 81243 12102 8	12	1/2	Hex	5/8	N/A	0.54	Carded
12202	3/4" X 12" Cold Chisel	0 81243 12202 5	12	5/8	Hex	3/4	N/A	0.69	Carded
12402	1" X 12" Cold Chisel	0 81243 12402 9	12	3/4	Hex	1	N/A	1.54	Carded
70200	1/4" Reg Ec Cold Chisel	0 45256 70200 1	5	1/4	Hex	1/4	N/A	0.07	Bulk
70201	5/16" Reg Ec Cold Chisel	0 45256 70201 8	5	1/4	Hex	5/16	N/A	0.07	Bulk
70202	3/8" Reg Ec Cold Chisel	0 45256 70202 5	5-1/2	5/16	Hex	3/8	N/A	0.13	Bulk
70204	7/16" Reg Ec Cold Chisel	0 45256 70204 9	6	3/8	Hex	7/16	N/A	0.20	Bulk
70205	1/2" Reg Ec Cold Chisel	0 45256 70205 6	6	7/16	Hex	1/2	N/A	0.25	Bulk
70207	1/2" X 12" Reg Ec Cold Chisel	0 45256 70207 0	12	7/16	Hex	1/2	Extra Long	0.53	Bulk
70209	5/8" Reg Ec Cold Chisel	0 45256 70209 4	6-1/2	1/2	Hex	5/8	N/A	0.37	Bulk
70210	5/8" X 12" Reg Ec Cold Chisel	0 45256 70210 0	12	1/2	Hex	5/8	Extra Long	0.69	Bulk
70212	3/4" Reg Ec Cold Chisel	0 45256 70212 4	7	5/8	Hex	3/4	N/A	0.60	Bulk
70213	3/4" X 12" Reg Ec Cold Chisel	0 45256 70213 1	12	5/8	Hex	3/4	Extra Long	1.09	Bulk
70216	7/8" Reg Ec Cold Chisel	0 45256 70216 2	7-1/2	3/4	Hex	7/8	N/A	0.90	Bulk
70217	7/8" X 12" Ec Cold Chisel	0 45256 70217 9	12	3/4	Hex	7/8	Extra Long	1.51	Bulk
70219	7/8" X 18" Ec Cold Chisel	0 45256 70219 3	18	3/4	Hex	7/8	Extra Long	2.40	Bulk
70220	1" Reg Ec Cold Chisel	0 45256 70220 9	8	7/8	Hex	1	N/A	1.25	Bulk
70221	1" X 12" Reg Ec Cold Chisel	0 45256 70221 6	12	3/4	Hex	1	Extra Long	1.53	Bulk



35102 – 3-1/2" X 7-1/4" Mason Chisel (p.11.0)



35602 – 1-3/4" X 7-1/2" Mason Chisel (p.11.0)



10402 – 1/2" X 6" Cold Chisel (above)



12402 – 1" X 12" Cold Chisel (above)



41602 – 3/8" Center Punch, 3/16" Pt (p.12.0)



43902 – 1/8" X 8" Line-Up Punch, Carded (p.12.1)

Chisels

Punches

Pry Bars

Handguarded

Specialty

Inspection

Sets and Kits



Center Punches

- Used for piercing, or marking for starting drills in metal and other materials
- Point sizes vary for larger or smaller holes
- If you want to scribe lines in metal, consider a prick punch
- Available in a shot-blasted finish
- Made in the USA

Item	Description	UPC Code	OAL	Body Size	Body Type	Blade Width	Blade Style	Weight (Lbs)	Pkg. Type
41202	5/16" Center Punch, 5/32" Pt	0 81243 41202 7	4-1/2	5/16	Hex	5/16	N/A	0.09	Carded
41602	3/8" Center Punch, 3/16" Pt	0 81243 41602 5	5	3/8	Hex	3/8	N/A	0.15	Carded
74000	1/4" Reg Ec Center Punch	0 45256 74000 3	4	1/4	Hex	3/32	N/A	0.04	Bulk
74001	5/16" Reg Ec Center Punch	0 45256 74001 0	4-1/2	5/16	Hex	5/32	N/A	0.09	Bulk
74002	3/8" Reg Ec Center Punch	0 45256 74002 7	5	3/8	Hex	3/8	N/A	0.15	Bulk
74003	1/2" Reg Ec Center Punch	0 45256 74003 4	6	1/2	Hex	5/16	N/A	0.34	Bulk
74004	5/8" Reg Ec Center Punch	0 45256 74004 1	6-1/4	5/8	Hex	3/8	N/A	0.50	Bulk
41702	1/2" Center Punch, 5/16 Pt	0 81243 41702 2	6	1/2	Hex	5/16	N/A	0.34	Carded



Solid Punches

- For loosening frozen or tight pins and keys, or knocking out rivets
- Variable point sizes for different sized pins and keys
- Once loosened, follow up with a pin punch to drive the pin or key out
- Available in a shot-blasted finish
- Made in the USA

Item	Description	UPC Code	OAL	Body Size	Body Type	Blade Width	Blade Style	Weight (Lbs)	Pkg. Type
70001	1/8" Reg Ec Solid Punch	0 45256 70001 4	5	3/8	Hex	1/8	N/A	0.15	Bulk
70002	3/16" Reg Ec Solid Punch	0 45256 70002 1	5	3/8	Hex	3/16	N/A	0.15	Bulk
20500	1/16" Reg Knurled Solid Punch	0 45256 20500 7	4	5/16	Round	1/16	N/A	0.07	Bulk
20501	3/32" Reg Knurled Solid Punch	0 45256 20501 4	4	5/16	Round	3/32	N/A	0.07	Bulk
20502	1/8" Reg Knurled Solid Punch	0 45256 20502 1	4	5/16	Round	1/8	N/A	0.08	Bulk
20503	5/32" Reg Knurled Solid Punch	0 45256 20503 8	4	5/16	Round	5/32	N/A	0.08	Bulk



Nail Set

- Used to drive finish nails into wood without damage, leaving a smooth finish
- Varying point sizes available for different sized nails
- Specialized application; not for use on any other metal besides nail heads
- Made in the USA

Item	Description	UPC Code	OAL	Body Size	Body Type	Blade Width	Blade Style	Weight (Lbs)	Pkg. Type
26000	1/32" Nail Set	0 45256 26000 6	4	1/4	Hex	1/32	N/A	0.07	Bulk
26001	2/32" Nail Set	0 45256 26001 3	4	1/4	Hex	1/16	N/A	0.07	Bulk
26002	3/32" Nail Set	0 45256 26002 0	4	1/4	Hex	3/32	N/A	0.08	Bulk



Prick Punch

- Used to scribe lines in metal before cutting or riveting
- Variable point sizes for different width marks
- Sharper angle specifically designed to scribe lines in metal
- Available in a shot-blasted finish
- Made in the USA

Item	Description	UPC Code	OAL	Body Size	Body Type	Blade Width	Blade Style	Weight (Lbs)	Pkg. Type
43502	7/32" X 5" Prick Punch	0 81243 43502 6	5	5/16	Hex	7/32	N/A	0.11	Carded
73002	3/8" Reg Ec Prick Punch	0 45256 73002 8	5	3/8	Hex	5/32	N/A	0.15	Bulk
23200	5/16" Reg Knurled Prick Punch	0 45256 23200 3	4	5/16	Round	1/8	N/A	0.08	Bulk



Mayhew Steel Products, Inc.
199 Industrial Blvd.
Turners Falls, MA 01376

U.S. Toll-Free Customer Service: 800-872-0037
Visit us online at www.Mayhew.com
Always wear safety goggles when using hand tools.

Version 2.2016
For the latest version, visit us
online at www.Mayhew.com

The Pros Know

Chisels

Punches

Pry Bars

Handguarded

Specialty

Inspection

Sets and Kits



Pin Punches

- Used to drive out and remove already loosened pins and keys after initial movement by a solid punch
- Variable point sizes and lengths for different applications
- Not for use on seized pins/keys; loosen with a solid punch first
- Available in fractional and metric sizes
- Available in a shot-blasted finish
- Made in the USA

Item	Description	UPC Code	OAL	Body Size	Body Type	Blade Width	Blade Style	Weight (Lbs)	Pkg. Type
42102	1/8" X 4-1/2" Pin Punch	0 81243 42102 9	4-1/2	1/4	Hex	1/8	N/A	0.09	Carded
42202	1/8" X 6" Long Pin Punch	0 81243 42202 6	6	5/16	Hex	1/8	N/A	0.14	Carded
42302	5/32" X 6" Pin Punch	0 81243 42302 3	6	5/16	Hex	5/32	N/A	0.10	Carded
42402	3/16" X 6" Long Pin Punch	0 81243 42402 0	6	5/16	Hex	3/16	N/A	0.16	Carded
42702	1/4" X 6" Long Pin Punch	0 81243 42702 1	6	7/16	Hex	1/4	N/A	0.17	Carded
71000	1/16" Reg Ec Pin Punch	0 45256 71000 6	4	1/4	Hex	1/16	N/A	0.05	Bulk
71001	3/32" Reg Ec Pin Punch	0 45256 71001 3	4-1/2	5/16	Hex	3/32	N/A	0.09	Bulk
71002	1/8" Reg Ec Pin Punch	0 45256 71002 0	4-3/4	5/16	Hex	1/8	N/A	0.09	Bulk
71003	5/32" Reg Ec Pin Punch	0 45256 71003 7	5	5/16	Hex	5/32	N/A	0.10	Bulk
71004	3/16" Reg Ec Pin Punch	0 45256 71004 4	5-1/4	3/8	Hex	3/16	N/A	0.16	Bulk
71005	1/4" Reg Ec Pin Punch	0 45256 71005 1	5-3/4	3/8	Hex	1/4	N/A	0.17	Bulk
71019	5/16" Reg Ec Pin Punch	0 45256 71019 8	6	7/16	Hex	5/16	N/A	0.24	Bulk
71500	1/8" Reg Ec Pin Punch	0 45256 71500 1	8	5/16	Hex	1/8	Extra Long	0.12	Bulk
71501	3/16" Reg Ec Pin Punch	0 45256 71501 8	8	3/8	Hex	3/16	Extra Long	0.16	Bulk
71502	1/4" Reg Ec Pin Punch	0 45256 71502 5	8	3/8	Hex	1/4	Extra Long	0.19	Bulk
71503	5/16" Reg Ec Pin Punch	0 45256 71503 2	8	7/16	Hex	5/16	Extra Long	0.28	Bulk
71504	3/8" Reg Ec Pin Punch	0 45256 71504 9	8	1/2	Hex	3/8	Extra Long	0.38	Bulk
42002	3/32" X 4-1/2" Pin Punch	0 81243 42002 2	4-1/2	1/4	Hex	3/32	Extra Long	0.09	Carded
21600	1/16" Min Knurled Pin Punch	0 45256 21600 3	2-3/4	3/16	Round	1/16	N/A	0.02	Bulk
21601	5/64" Min Knurled Pin Punch	0 45256 21601 0	2-3/4	3/16	Round	5/64	N/A	0.02	Bulk
21602	3/32" Min Knurled Pin Punch	0 45256 21602 7	2-3/4	3/16	Round	3/32	N/A	0.02	Bulk
21701	1/16" Reg Knurled Pin Punch	0 45256 21701 7	4	1/4	Round	1/16	N/A	0.04	Bulk
21702	3/32" Reg Knurled Pin Punch	0 45256 21702 4	4	1/4	Round	3/32	N/A	0.04	Bulk
21703	1/8" Reg Knurled Pin Punch	0 45256 21703 1	4	5/16	Round	1/8	N/A	0.06	Bulk
21704	5/32" Reg Knurled Pin Punch	0 45256 21704 8	4	5/16	Round	5/32	N/A	0.07	Bulk
21705	3/16" Reg Knurled Pin Punch	0 45256 21705 5	4	5/16	Round	3/16	N/A	0.07	Bulk
21706	7/32" Reg Knurled Pin Punch	0 45256 21706 2	4	3/8	Round	7/32	N/A	0.10	Bulk
21707	1/4" Reg Knurled Pin Punch	0 45256 21707 9	4	3/8	Round	1/4	N/A	0.10	Bulk
21708	5/16" Reg Knurled Pin Punch	0 45256 21708 6	4	1/2	Round	5/16	N/A	0.19	Bulk



Line-Up Punches

- Used to align holes through which rivets, pins, or bolts will be inserted
- Not for use when driving pins, rivets, or bolts
- Variable point size, shank size, and taper length for the perfect alignment
- Available in a shot-blasted finish
- Made in the USA

Item	Description	UPC Code	OAL	Body Size	Body Type	Blade Width	Blade Style	Weight (Lbs)	Pkg. Type
43902	1/8" X 8" Line-Up Punch, Carded	0 81243 43902 4	8	5/16	Hex	1/8	N/A	0.15	Carded
43952	5/32" X 9" Line-Up Punch, Carded	0 81243 43952 9	9	3/8	Hex	5/32	N/A	0.35	Carded
44002	3/16" X 9" Line-Up Punch, Carded	0 81243 44002 0	9	3/8	Hex	3/16	N/A	0.44	Carded
44102	1/4" X 12" Line-Up Punch, Carded	0 81243 44102 7	12	5/8	Hex	1/4	N/A	0.82	Carded
44202	5/16" X 12" Line-Up Punch, Carded	0 81243 44202 4	12	5/8	Hex	5/16	N/A	0.94	Carded
72003	1/4" Reg Ec Line-Up Punch	0 45256 72003 6	12	5/8	Hex	1/4	N/A	0.82	Bulk
72010	1/8" Reg Ec Line-Up Punch	0 45256 72010 4	8	5/16	Hex	1/8	N/A	0.15	Bulk
72011	5/32" Reg Ec Line-Up Punch	0 45256 72011 1	9	3/8	Hex	5/32	N/A	0.23	Bulk
72012	3/16" Reg Ec Line-Up Punch	0 45256 72012 8	10	1/2	Hex	3/16	N/A	0.44	Bulk

Chisels

Punches

Pry Bars

Handguarded

Specialty

Inspection

Sets and Kits



Line-Up Pry Bar

- Long, tapered end for aligning and adjusting metal or woods
- Angled chisel end for extra leverage when prying
- Available in a variety of lengths for work in hard-to-reach spots and more leverage
- Shot-blast finish
- Made in the USA

Item	Description	UPC Code	OAL	Body Size	Body Type	Blade Width	Blade Style	Weight (Lbs)	Pkg. Type
75000	14" Line-Up Pry Bar	0 45256 75000 2	14	1/2	Hex	5/8	N/A	0.72	Bulk
75001	16" Line-Up Pry Bar	0 45256 75001 9	16	5/8	Hex	3/4	N/A	1.21	Bulk
75002	20" Line-Up Pry Bar	0 45256 75002 6	20	3/4	Hex	7/8	N/A	2.23	Bulk



Rolling Head Pry Bar

- Long tapered end for aligning and adjusting metal or wood
- 90 degree angled chisel end for extra leverage when prying
- Rolling head provides extra leverage and helps dislodge heavy items
- Shot-blast finish
- Made in the USA

Item	Description	UPC Code	OAL	Body Size	Body Type	Blade Width	Blade Style	Weight (Lbs)	Pkg. Type
75101	16" Rolling Head Pry Bar	0 45256 75101 6	16	1/2	Hex	5/8	N/A	0.93	Bulk



Select Pry Bar

- Used for lifting and prying
- Available in curved blade styles
- Heat treated along the entire length of the steel
- Chrome vanadium shaft with corrosion-resistant finish
- Made in Taiwan

Item	Description	UPC Code	OAL	Body Size	Body Type	Blade Width	Blade Style	Weight (Lbs)	Pkg. Type
45006	8" MayhewSelect™ Pry Bar	0 45256 45006 3	8	N/A	Square	7/16	N/A	0.32	Bulk
45007	12" MayhewSelect™ Pry Bar	0 45256 45007 0	12	N/A	Square	5/8	N/A	0.65	Bulk
45008	18" MayhewSelect™ Pry Bar	0 45256 45008 7	18	N/A	Square	3/4	N/A	1.29	Bulk
45009	24" MayhewSelect™ Pry Bar	0 45256 45009 4	24	N/A	Square	3/4	N/A	0.44	Bulk



Straight Pinch Bar

- Used to align, adjust, move, and pry metal or woods
- Available in multiple sizes and lengths for the right amount of strength for the job
- Shot-blast finish
- Made in the USA

Item	Description	UPC Code	OAL	Body Size	Body Type	Blade Width	Blade Style	Weight (Lbs)	Pkg. Type
75125	14" Straight Pinch Bar	0 45256 75125 2	14	1/2	Hex	N/A	Straight	0.72	Bulk
75126	16" Straight Pinch Bar	0 45256 75126 9	16	5/8	Hex	N/A	Straight	1.21	Bulk
75127	20" Straight Pinch Bar	0 45256 75127 6	20	3/4	Hex	N/A	Straight	2.23	Bulk

Chisels

Punches

Pry Bars

Handguarded

Specialty

Inspection

Sets and Kits



Gooseneck Wrecking Bars

- Used in demolition for pulling, prying, and for removing nails from hard wood with minimal damage to the wood
- Available in a multitude of lengths and body sizes for the perfect tool to fit the job
- Powder-coated finish
- Made in the USA

Item	Description	UPC Code	OAL	Body Size	Body Type	Blade Width	Blade Style	Weight (Lbs)	Pkg. Type
41001	18" Gooseneck Wrecking Bar	0 45256 41001 2	18	5/8	Hex	N/A	N/A	1.9	Bulk
41002	24" Gooseneck Wrecking Bar	0 45256 41002 9	24	3/4	Hex	N/A	N/A	3.35	Bulk
41003	30" Gooseneck Wrecking Bar	0 45256 41003 6	30	3/4	Hex	N/A	N/A	3.9	Bulk
41004	36" Gooseneck Wrecking Bar	0 45256 41004 3	36	3/4	Hex	N/A	N/A	4.6	Bulk



Molding Bar

- Used for prying, lifting, and pulling baseboard and door molding
- One size fits all applications
- Powder-coated finish
- Made in the USA

Item	Description	UPC Code	OAL	Body Size	Body Type	Blade Width	Blade Style	Weight (Lbs)	Pkg. Type
41275	10" Molding Lifter Bar	0 45256 41275 7	10	1/2	Hex	N/A	N/A	0.65	Bulk



Nail Pullers

- Used to remove nails from the hardest of woods
- Specially designed head for removing the toughest nails
- Available in single, double ended, or combo (one end nail puller, one end pry bar)
- Made in the USA

Item	Description	UPC Code	OAL	Body Size	Body Type	Blade Width	Blade Style	Weight (Lbs)	Pkg. Type
41100	Single Nail Puller	0 45256 41100 2	10	5/8	Hex	N/A	N/A	1.05	Bulk
41101	Double Nail Puller	0 45256 41101 9	10	5/8	Hex	N/A	N/A	1.05	Bulk
41300	14" Double Utility Bar	0 45256 41300 6	14	1-3/8	Flat	N/A	N/A	1.53	Bulk
41102	15" Nail Puller/Combo	0 45256 41102 6	15	5/8	Hex	N/A	N/A	1.4	Bulk
98602	Mini Utility Bar	0 81243 98602 3	7-1/2	N/A	Flat	1	N/A	0.25	Carded



Ripping Chisel

- Used to rip apart building materials and for pulling apart studs
- Has handy nail slots to help remove stubborn nails when separating wood
- Available single or double ended
- Powder-coated finish
- Made in the USA

Item	Description	UPC Code	OAL	Body Size	Body Type	Blade Width	Blade Style	Weight (Lbs)	Pkg. Type
41200	18" Ripping Chisel Single	0 45256 41200 9	18	3/4	Square	N/A	N/A	2.35	Bulk
41201	18" Ripping Chisel Double	0 45256 41201 6	18	3/4	Square	N/A	N/A	2.355	Bulk



Tweaker™

- Used to tweak or adjust bent or warped lumber; adjust studs, joints, or rafters
- Demolition uses include pulling nails, wedging, stripping, and wrecking
- Only for use on lumber
- Powder-coated finish with a cushion-grip handle
- Made in Taiwan

Item	Description	UPC Code	OAL	Body Size	Body Type	Blade Width	Blade Style	Weight (Lbs)	Pkg. Type
41500	Tweaker	0 45256 41500 0	14-1/2	3/4	Hex	N/A	N/A	2.1	Clamshell

Chisels

Punches

Pry Bars

Handguarded

Specialty

Inspection

Sets and Kits



Handguarded Cold Chisels

- Used to cut and shape metals softer than the cutting edge of the chisel
- Cutting edge angle designed to provide greater strength
- Cold chisel is not intended to be used on masonry materials
- Available in a variety of lengths and sizes to fit any application
- Available in a shot-blasted finish
- Made in the USA

Item	Description	UPC Code	OAL	Body Size	Body Type	Blade Width	Blade Style	Weight (Lbs)	Pkg. Type
10605	3/4" X 7" Handguarded Cold Chisel	0 81243 10605 6	7	5/8	Hex	3/4	N/A	0.88	Plastic Bag
10805	1" X 8" Handguarded Cold Chisel	0 81243 10805 0	8	3/4	Hex	1	N/A	1.58	Plastic Bag
12205	3/4" X 12" Handguarded Chisel	0 81243 12205 6	12	5/8	Hex	3/4	N/A	1.38	Plastic Bag
12405	1" X 12" Handguarded Cold Chisel	0 81243 12405 0	12	3/4	Hex	1	N/A	1.82	Plastic Bag



Handguarded Mason Chisels

- Used in a multitude of masonry applications, from brick to stone to concrete
- Allows for specific cuts, sizes, and scores. Different cutting edge lengths provide the perfect sized tool for the perfect finished look
- Shot-blasted finish
- Made in the USA

Item	Description	UPC Code	OAL	Body Size	Body Type	Blade Width	Blade Style	Weight (Lbs)	Pkg. Type
35005	3" Handguarded Mason Chisel	0 81243 35005 3	7-3/4	7/8	Hex	3	N/A	1.93	Plastic Bag
35105	3-1/2" Handguarded Mason Chisel	0 81243 35105 0	7	7/8	Hex	3-1/2	N/A	1.93	Plastic Bag
35205	4" Handguarded Mason Chisel	0 81243 35205 7	7-1/2	1	Hex	4	N/A	1.97	Plastic Bag
35705	2-1/4" X 7-3/4" Handguarded Mason Chisel	0 81243 35705 2	7-3/4	5/8	Hex	2-1/4	N/A	1.24	Plastic Bag



Handguarded Bullpoint Chisel

- Used to break up and demolish concrete
- Used where an air chisel is impractical
- Shot-blasted finish
- Made in the USA

Item	Description	UPC Code	OAL	Body Size	Body Type	Blade Width	Blade Style	Weight (Lbs)	Pkg. Type
80205	3/4" X 12" Handguarded Bullpoint	0 81243 80205 7	12	3/4	Hex	3/4	N/A	2.04	Plastic Bag



Handguarded Floor Chisel

- Used to cut and trim wood and to pull tongue and groove materials together
- Thin blade allows for access to tight spaces
- Shot-blasted finish
- Made in the USA

Item	Description	UPC Code	OAL	Body Size	Body Type	Blade Width	Blade Style	Weight (Lbs)	Pkg. Type
94105	2-1/2" Handguarded Floor Chisel	0 81243 94105 3	10-1/2	5/8	Hex	2-1/2	N/A	1.57	Plastic Bag



Handguarded Electrician's Chisel

- Used for cutting out plaster, drywall, and other renovation work
- Shot-blasted finish
- Made in the USA

Item	Description	UPC Code	OAL	Body Size	Body Type	Blade Width	Blade Style	Weight (Lbs)	Pkg. Type
94505	2-3/4" X 9" Handguarded Electrician's Chisel	0 81243 94505 1	9	3/4	Hex	2-3/4	N/A	1.27	Plastic Bag



Mayhew Steel Products, Inc.
199 Industrial Blvd.
Turners Falls, MA 01376

U.S. Toll-Free Customer Service: 800-872-0037
Visit us online at www.Mayhew.com
Always wear safety goggles when using hand tools.

Version 2.2016
For the latest version, visit us
online at www.Mayhew.com

The Pros Know

Chisels

Punches

Pry Bars

Handguarded

Specialty

Inspection

Sets and Kits



45680 - Hose Clamp Pliers

Replaces 45650

- Used to loosen and remove a wide variety of automotive hose clamps
- Long, flexible cable allows for use in hard-to-reach areas
- Spring loaded
- Made in France

Hose Clamp Pliers

Item	Description	UPC Code	OAL	Body Size	Body Type	Blade Width	Blade Style	Weight (Lbs)	Pkg. Type
45680	MayhewSelect™ Hose Clamp Pliers	0 45256 45680 5	14-3/4	N/A	N/A	N/A	N/A	1.03	Clamshell



Belt/Molding Remover

Item	Description	UPC Code	OAL	Body Size	Body Type	Blade Width	Blade Style	Weight (Lbs)	Pkg. Type
45049	MayhewSelect™ Belt/Molding Removal	0 45256 45049 0	12-1/2	N/A	N/A	N/A	N/A	0.47	Bulk



Stud Extractor

- Used to remove seized or broken studs and bolts
- Designed to fit into small areas, where studs may be hard to reach
- Made out of high-grade, heat-treated alloy steel
- Chrome finish for additional rust protection and aesthetic appeal
- Use with a 3/8" impact wrench, on low
- Made in Taiwan to Mayhew's specifications

Item	Description	UPC Code	OAL	Body Size	Body Type	Blade Width	Blade Style	Weight (Lbs)	Pkg. Type
29895	Stud Extractor	0 45256 29895 5	7-5/8	N/A	N/A	N/A	N/A	0.86	Bulk

Flexible Bit/Socket Drivers



Item	Description	UPC Code	OAL	Body Size	Body Type	Blade Width	Blade Style	Weight (Lbs)	Pkg. Type
45016	1/4" MayhewSelect™ Flexible Bit Driver	0 45256 45016 2	9-1/2	N/A	Round	1/4	N/A	0.74	Bulk
45017	1/4" MayhewSelect™ Flexible Socket Driver	0 45256 45017 9	9-1/2	N/A	Round	1/4	N/A	0.74	Bulk



45053 - 9 PC Metric Twisted Hex Key



45052 - 9 PC SAE Twisted Hex Key

Twisted Hex Keys

- Superior Quality S2 Tool Steel
- Twisted prior the heat treat to increase torque capacity
- Longer shaft for added leverage
- Exceeds ANSI standards
- Color coated to resist corrosion, manganese-phosphate contact areas to resist wear
- Available in fractional or metric sizes

Item	Description	UPC Code	OAL	Body Size	Body Type	Blade Width	Blade Style	Weight (Lbs)	Pkg. Type
45052	MayhewSelect™ 9 Pc SAE Twisted Hex Key Set	0 45256 45052 0	10	N/A	N/A	N/A	N/A	0.79	Display Box
45053	MayhewSelect™ 9 Pc Metric Twisted Hex Key Set	0 45256 45053 7	10	N/A	N/A	N/A	N/A	0.82	Display Box

Chisels

Punches

Pry Bars

Handguarded

Specialty

Inspection

Sets and Kits



Screwdrivers – Phillips

- Used to fasten and unfasten screws in almost any setting with a Phillips bit
- Designed with an extended blade forged with a capped end
- Hex bolster for use with a wrench for increased torque
- Black oxide tips for a better grip on the screw
- Made in Taiwan

Item	Description	UPC Code	OAL	Body Size	Body Type	Blade Width	Blade Style	Weight (Lbs)	Pkg. Type
45000	#1" X 3" Phillips Sd	0 45256 45000 1	3	N/A	Hex	1	N/A	0.29	Bulk
45001	#2" X 4" Phillips Sd	0 45256 45001 8	4	N/A	Hex	2	N/A	0.32	Bulk
45002	#3" X 6" Phillips Sd	0 45256 45002 5	6	N/A	Hex	3	N/A	0.51	Bulk
45010	#2" X 7-3/4" Phillips Sd	0 45256 45010 0	7-3/4	N/A	Hex	2	N/A	0.40	Bulk
45011	#2" X 12" Phillips Sd	0 45256 45011 7	12	N/A	Hex	2	N/A	0.44	Bulk
45012	#2" X 17-3/4" Phillips Sd	0 45256 45012 4	17-3/4	N/A	Hex	2	N/A	0.51	Bulk
45018	#2" X 6" Phillips Sd	0 45256 45018 6	6	N/A	Hex	2	N/A	0.36	Bulk
45019	#2" X 1-1/2" Phillips Sd	0 45256 45019 3	1-1/2	N/A	Hex	2	N/A	0.12	Bulk



Screwdrivers – Slotted

- Used to fasten and unfasten screws in almost any setting with a slotted bit
- Designed with an extended blade forged with a capped end
- Hex bolster for use with a wrench for increased torque
- Black oxide tips for a better grip on the screw
- Made in Taiwan

Item	Description	UPC Code	OAL	Body Size	Body Type	Blade Width	Blade Style	Weight (Lbs)	Pkg. Type
45003	7/32" X 4" Slotted Sd	0 45256 45003 2	4	N/A	Hex	7/32	N/A	0.29	Bulk
45004	1/4" X 6" Slotted Sd	0 45256 45004 9	6	N/A	Hex	1/4	N/A	0.34	Bulk
45005	5/16" X 7" Slotted Sd	0 45256 45005 6	7	N/A	Hex	5/16	N/A	0.53	Bulk
45013	5/16" X 17-3/4" Slotted Sd	0 45256 45013 1	17-3/4	N/A	Hex	5/16	N/A	0.55	Bulk
45014	5/16" X 12" Slotted Sd	0 45256 45014 8	12	N/A	Hex	5/16	N/A	0.36	Bulk
45020	3/8" X 8" Slotted Sd	0 45256 45020 9	8	N/A	Hex	3/8	N/A	0.12	Bulk
45021	1/4" X 1-1/2" Slotted Sd	0 45256 45021 6	1-1/2	N/A	Hex	1/4	N/A	0.56	Bulk



Scratch Awl

- Used for a wide variety of applications, such as automotive and electrical work in confined spaces, scribing lines, o-ring and cotter pin removal, and to break radiator connections
- Made of larger shank steel for heavy-duty applications
- Made in the USA

Item	Description	UPC Code	OAL	Body Size	Body Type	Blade Width	Blade Style	Weight (Lbs)	Pkg. Type
46502	1/4" Scratch Awl, 5-1/2" Blade	0 81243 46502 3	10-1/2	1/4	Round	1/4	N/A	0.15	Blister Pack

Air Nozzles



17055 – ABGPV1 Pivot Air Blow Gun



17065 – ABGTTEL1 Telescoping Air Nozzle

Item	Description	UPC Code	OAL	Body Size	Body Type	Blade Width	Blade Style	Weight (Lbs)	Pkg. Type
17055	ABGPV1 Pivot Air Blow Gun	0 45256 17055 8	12-1/2	N/A	N/A	N/A	N/A	0.27	Carded
17065	ABGTTEL1 Telescoping Air Nozzle	0 45256 17065 7	13-1/2	N/A	N/A	N/A	N/A	0.29	Carded



Mayhew Steel Products, Inc.
199 Industrial Blvd.
Turners Falls, MA 01376

U.S. Toll-Free Customer Service: 800-872-0037
Visit us online at www.Mayhew.com
Always wear safety goggles when using hand tools.

Version 2.016
For the latest version, visit us
online at www.Mayhew.com

The Pros Know

Chisels

Punches

Pry Bars

Handguarded

Specialty

Inspection

Sets and Kits



17150 – SSMR01 Stainless Steel Mirror

- Used to view or magnify hard-to-see places
- Original patented design with a 180° swivel, designed to hold its position
- Available in a straight extendable or flexible shaft
- Specialty stethoscope tool also available for identifying sounds
- Made in the USA

Mirror & Magnifying

Item	Description	UPC Code	OAL	Body Size	Body Type	Blade Width	Blade Style	Weight (Lbs)	Pkg. Type
17020	TKFIER Magnifier W/Coupler	0 45256 17020 6	3-1/4	N/A	N/A	N/A	N/A	0.04	Bulk
17030	TKSSANT SS Antenna W/Coupler	0 45256 17030 5	7	N/A	N/A	N/A	N/A	0.15	Carded
17035	TKTORCH Flashlight W/SS Antenna	0 45256 17035 0	7-1/2	N/A	N/A	N/A	N/A	0.33	Bulk
17150	SSMR01 Stainless Steel Mirror	0 45256 17150 0	6-3/4	N/A	N/A	N/A	Curved	0.20	Carded
17300	TK02MIR Mirror W/Coupler	0 45256 17300 9	3	N/A	N/A	N/A	N/A	0.04	Bulk
17305	TF01 Telescoping Magnifier	0 45256 17305 4	7	N/A	N/A	N/A	N/A	0.14	Carded
17320	TK01MIR Mirror W/Coupler	0 45256 17320 7	4	N/A	N/A	N/A	N/A	0.05	Bulk
17330	TK03MIR Mirror W/Coupler	0 45256 17330 6	3	N/A	N/A	N/A	N/A	0.02	Bulk
17600	FF01 Flex Shaft W/Magnifier	0 45256 17600 0	22-1/4	N/A	N/A	N/A	N/A	0.25	Carded
17615	FMR01 Flex Shaft W/Mirror	0 45256 17615 4	22-1/4	N/A	N/A	N/A	N/A	0.25	Carded
17750	MR01 Inspection Telescoping Mirror	0 45256 17750 2	7-3/4	N/A	N/A	N/A	N/A	0.15	Carded
17755	MR02 Inspection Telescoping Mirror	0 45256 17755 7	7	N/A	N/A	N/A	N/A	0.10	Carded
17760	MR03 Inspection Telescoping Mirror	0 45256 17760 1	6-3/4	N/A	N/A	N/A	N/A	0.10	Carded
17765	MR04 Inspection Telescoping Mirror	0 45256 17765 6	8-3/4	N/A	N/A	N/A	N/A	0.25	Plastic Bag
17770	MGMR01 3X Magnified Glass Mirror	0 45256 17770 0	7	N/A	N/A	N/A	N/A	0.20	Carded
17805	PM01B-M Pen Magnet W/Mirror	0 45256 17805 9	6-1/4	N/A	N/A	N/A	N/A	0.50	Carded



- Used to pick up hard-to-reach items through magnetic or mechanical means
- Available in a straight extendable shaft, flexible shaft, or both

Pick-Up Tools

Item	Description	UPC Code	OAL	Body Size	Body Type	Blade Width	Blade Style	Weight (Lbs)	Pkg. Type
17025	TKFLEX Quick Change Flex	0 45256 17025 1	21-3/4	N/A	N/A	N/A	N/A	0.20	Bulk
17315	TK01MAG 14 lb Magnet W/Coupler	0 45256 17315 3	4-1/2	N/A	N/A	N/A	N/A	0.07	Bulk
17325	TK03MAG 3 lb Magnet W/Coupler	0 45256 17325 2	4	N/A	N/A	N/A	N/A	0.03	Bulk
17605	PFM01 Flex Shaft W/3 lb Magnet	0 45256 17605 5	22	N/A	N/A	N/A	N/A	0.20	Carded
17610	FM02 Flex Shaft W/14 lb Magnet	0 45256 17610 9	22	N/A	N/A	N/A	N/A	0.25	Carded
17800	PM01 Pen Magnet	0 45256 17800 4	5-3/4	N/A	N/A	N/A	N/A	0.50	Carded
17810	PMG01 14 lb Magnet W/SS Telescope	0 45256 17810 3	7-1/2	N/A	N/A	N/A	N/A	0.15	Carded
17830	PMG02 14 lb Swiv Head Mag W/SS	0 45256 17830 1	8	N/A	N/A	N/A	N/A	0.20	Carded
45046	Lighted Flex Claw Tool	0 45256 45046 9	14-1/2	N/A	N/A	N/A	N/A	0.47	Display Box
45048	Flexible Lighted Pick-Up Tool	0 45256 45048 3	10	N/A	N/A	N/A	N/A	0.43	Display Box
45056	Lighted Magnetic Claw Tool	0 45256 45056 8	14-1/5	N/A	N/A	N/A	N/A	0.54	Display Box
17845	PMG03 3 lb Magnet W/SS Telescope	0 45256 17845 5	7	N/A	N/A	N/A	N/A	0.10	Carded

Replacement Parts

Item	Description	UPC Code	OAL	Body Size	Body Type	Blade Width	Blade Style	Weight (Lbs)	Pkg. Type
17006	TK02 Bulb 0.75A Krypton	0 45256 17006 0	3-1/2	N/A	N/A	N/A	N/A	0.02	Bulk
17101	RPMIRO1 Replacement Mirror	0 45256 17101 2	N/A	N/A	N/A	N/A	N/A	0.04	Plastic Bag
17102	RPMIRO2 Replacement Mirror	0 45256 17102 9	N/A	N/A	N/A	N/A	N/A	0.03	Plastic Bag
17103	RPMIRO3 Replacement Mirror	0 45256 17103 6	N/A	N/A	N/A	N/A	N/A	0.01	Plastic Bag
17110	RPPIV1 Replacement Nozzle for 17055	0 45256 17110 4	N/A	N/A	N/A	N/A	N/A	0.08	Plastic Bag
17121	RPTL1 Replacement Nozzle for 17065	0 45256 17121 0	N/A	N/A	N/A	N/A	N/A	0.08	Plastic Bag

Chisels

Punches

Pry Bars

Handguarded

Specialty

Inspection

Sets and Kits

Inspection Kits

Item	Description	UPC Code	OAL	Body Size	Body Type	Blade Width	Blade Style	Weight (Lbs)	Pkg. Type
17705	TK3000 Magnet/Mirror Kit 17755 – MR02 Inspection Tel Mirror 17830 – PMG02 14 lb Swiv Head Mag W/SS	0 45256 17705 2	N/A	N/A	N/A	N/A	N/A	0.57	Bulk
17715	Tk5000 Torch Kit W/5 Cmpts 17020 – TKFIER Magnifier W/Coupler 17035 – TKTORCH Flashlight W/SS Antenna 17300v – TK02MIR Mirror W/Coupler 17315 – TK01MAG 14 lb Magnet W/Coupler 17325 – TK03MAG 3 lb Magnet W/Coupler 17330 – TK03MIR Mirror W/Coupler	0 45256 17715 1	N/A	N/A	N/A	N/A	N/A	0.98	Bulk
17720	TK6000 5 Pc Telemulti Kit 17020 – TKFIER Magnifier W/Coupler 17030 – TKSSANT SS Antenna W/Coupler 17300 – TK02MIR Mirror W/Coupler 17315 – TK01MAG 14 lb Magnet W/Coupler 17325 – TK03MAG 3 lb Magnet W/Coupler	0 45256 17720 5	N/A	N/A	N/A	N/A	N/A	0.57	Bulk
17730	TK8000 Teleflex W/6 Cmpts 17020 – TKFIER Magnifier W/Coupler 17025 – TKFLEX Quick Change Flex 17030 – TKSSANT SS Antenna W/Coupler 17300 – TK02MIR Mirror W/Coupler 17315 – TK01MAG 14 lb Magnet W/Coupler 17325 – TK03MAG 3 lb Magnet W/Coupler 17330 – TK03MIR Mirror W/Coupler	0 45256 17730 4	N/A	N/A	N/A	N/A	N/A	1.45	Bulk
17680	TK1000 Telmag Tool Kit 17755 – MR02 Inspection Tel Mirror 17810 – PMG01 14 lb Magnet W/SS Telescope	0 45256 17680 2	N/A	N/A	N/A	N/A	N/A	0.55	Bulk
17690	TK20/20SE Teluminatr Torch Kit 17020 – TKFIER Magnifier W/Coupler 17035 – TKTORCH Flashlight W/SS Antenna 17300 – TK02MIR Mirror W/Coupler 17315 – TK01MAG 14 lb Magnet W/Coupler 17320 – TK01MIR Mirror W/Coupler 17325 – TK03MAG 3 lb Magnet W/Coupler 17330 – TK03MIR Mirror W/Coupler	0 45256 17690 1	N/A	N/A	N/A	N/A	N/A	1.9	Bulk



17705 – Magnet/Mirror Kit



17715 – Torch Kit W/5 Cmpts



17720 – 5 Pc Telemulti Kit



17730 – Teleflex W/6 Cmpts



17680 – Telmag Tool Kit



17690 – Teluminatr Torch Kit



Mayhew Steel Products, Inc.
199 Industrial Blvd.
Turners Falls, MA 01376

U.S. Toll-Free Customer Service: 800-872-0037
Visit us online at www.Mayhew.com
Always wear safety goggles when using hand tools.

Version 2.2016
For the latest version, visit us
online at www.Mayhew.com

The Pros Know

Chisels

Punches

Pry Bars

Handguarded

Specialty

Inspection

Sets and Kits



89062 – 3 Pc Cold Chisel Set



90002 – 5 Pc Cold Chisel Set

Cold Chisel Sets

Item	Description	UPC Code	OAL	Body Size	Body Type	Blade Width	Blade Style	Weight (Lbs)	Pkg. Type
89062	3 Pc Cold Chisel Set 10302 – 3/8" X 5" Cold Chisel 10402 – 1/2" X 6" Cold Chisel 10502 – 5/8" X 6-1/2" Cold Chisel	0 81243 89062 7	N/A	N/A	Hex	N/A	N/A	0.64	Carded
90002	5 Pc Cold Chisel Set 70212 – 3/4" Reg Ec Cold Chisel	0 81243 90002 9	N/A	N/A	Hex	N/A	N/A	1.56	Carded

Punch & Chisel Sets

Item	Description	UPC Code	OAL	Body Size	Body Type	Blade Width	Blade Style	Weight (Lbs)	Pkg. Type
85002	4 Pc Handguard Set 12205 – 3/4" x 12" Handguarded Chisel 35005 – 3" Handguarded Brick Set 35705 – 2-1/4" X 7-3/4" Handguarded Mason Chisel 94105 – 2-1/2" Handguarded Floor Chisel	0 45256 85002 3	N/A	N/A	Hex	N/A	N/A	6.5	Bulk
61025	8 Pc Ec Punch & Chisel Kit 70002 – 3/16" Reg Ec Solid Punch 70202 – 3/8" Reg Ec Cold Chisel 70205 – 1/2" Reg Ec Cold Chisel 70209 – 5/8" Reg Ec Cold Chisel 71002 – 1/8" Reg Ec Pin Punch 71004 – 3/16" Reg Ec Pin Punch 71005 – 1/4" Reg Ec Pin Punch 74002 – 3/8" Reg Ec Center Punch	0 45256 61025 2	N/A	N/A	Hex	N/A	N/A	1.53	Pouch
76005	6 Pc Punch & Chisel Kit 70002 – 3/16" Reg Ec Solid Punch 70205 – 1/2" Reg Ec Cold Chisel 70209 – 5/8" Reg Ec Cold Chisel 71002 – 1/8" Reg Ec Pin Punch 71004 – 3/16" Reg Ec Pin Punch 74002 – 3/8" Reg Ec Center Punch	0 45256 76005 6	N/A	N/A	Hex	N/A	N/A	1.25	Pouch
90402	5 Pc Punch & Chisel Set, Carded 10402 – 1/2" X 6" Cold Chisel 40101B – 1/8" Reg Ec Solid Punch 42202 – 1/8" X 6" Long Pin Punch 70212 – 3/4" Reg Ec Cold Chisel 74001 – 5/16" Reg Ec Center Punch	0 81243 90402 7	N/A	N/A	Hex	N/A	N/A	1.25	Clamshell
61040	12 Pc Punch & Chisel Set 70001 – 1/8" Reg Ec Solid Punch 70200 – 1/4" Reg Ec Cold Chisel 70202 – 3/8" Reg Ec Cold Chisel 70209 – 5/8" Reg Ec Cold Chisel 71001 – 3/32" Reg Ec Pin Punch 71002 – 1/8" Reg Ec Pin Punch 71003 – 5/32" Reg Ec Pin Punch 71004 – 3/16" Reg Ec Pin Punch 71005 – 1/4" Reg Ec Pin Punch 72011 – 5/32" Reg Ec Line-Up Punch 73002 – 3/8" Reg Ec Prick Punch 74002 – 3/8" Reg Ec Center Punch	0 45256 61040 5	N/A	N/A	Hex	N/A	N/A	1.95	Clamshell

Chisels

Punches

Pry Bars

Handguarded

Specialty

Inspection

Sets and Kits

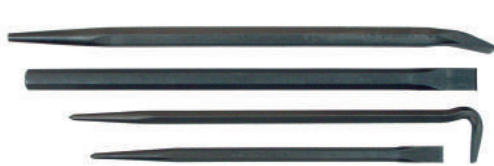

76284 – 4 Pc Ec Pry Bar Set



66302 – 4 Pc Pry Bar Set

Pry Bar Sets

Item	Description	UPC Code	OAL	Body Size	Body Type	Blade Width	Blade Style	Weight (Lbs)	Pkg. Type
76284	4 Pc Ec Pry Bar Set 70219 – 7/8" X 18" Ec Cold Chisel 75000 – Reg Ec 14" Line-Up Pry Bar 75002 – Reg Ec 20" Line-Up Pry Bar 75101 – Reg Ec 16" Rolling HD Pry Bar	0 45256 76284 5	N/A	N/A	Hex	N/A	N/A	6.5	Tray
66302	4 Pc Pry Bar Set 45006 – 8" MayhewSelect™ Pry Bar 45007 – 12" MayhewSelect™ Pry Bar 45008 – 18" MayhewSelect™ Pry Bar 45009 – 24" MayhewSelect™ Pry Bar	0 45256 66302 9	N/A	N/A	Hex	N/A	N/A	4.61	N/A



66300 – 6 Pc Capped End Screwdriver Set

Screwdriver Sets

Item	Description	UPC Code	OAL	Body Size	Body Type	Blade Width	Blade Style	Weight (Lbs)	Pkg. Type
66300	6 Pc Capped End Screwdriver Set 45000 – #1 X 3 MayhewSelect™ Phillips Sd 45001 – #2 X 4 MayhewSelect™ Phillips Sd 45002 – #3 X 6 MayhewSelect™ Phillips Sd 45003 – 7/32 X 4 MayhewSelect™ Slotted Sd 45004 – 1/4 X 6 MayhewSelect™ Slotted Sd 45005 – 5/16 X 7 MayhewSelect™ Slotted Sd	0 45256 66300 5	N/A	N/A	Hex	N/A	N/A	3.62	N/A
66306	10 Pc Screwdriver Set 45000 – #1 X 3 MayhewSelect™ Phillips Sd 45001 – #2 X 4 MayhewSelect™ Phillips Sd 45002 – #3 X 6 MayhewSelect™ Phillips Sd 45003 – 7/32 X 4 MayhewSelect™ Slotted Sd 45004 – 1/4 X 6 MayhewSelect™ Slotted Sd 45005 – 5/16 X 7 MayhewSelect™ Slotted Sd 45018 – #2 X 6 MayhewSelect™ Phillips Sd 45019 – #2 X 1-1/2 MayhewSelect™ Phillips Sd 45020 – 3/8 X 8 MayhewSelect™ Slotted Sd 45021 – 1/4 X 1-1/2 MayhewSelect™ Slotted Sd	0 45256 66306 7	N/A	N/A	Hex	N/A	N/A	3.96	N/A

Flexible Bit & Socket Driver Set

Item	Description	UPC Code	OAL	Body Size	Body Type	Blade Width	Blade Style	Weight (Lbs)	Pkg. Type
66305	2 Pc Flexible Bit & Socket Driver Set 45016 – 1/4" MayhewSelect™ Flexible Bit Driver 45017 – 1/4" Mayhew Select™ Flexible Socket Driver	0 45256 66305 0	N/A	N/A	Round	N/A	N/A	1.71	N/A



Mayhew Steel Products, Inc.
199 Industrial Blvd.
Turners Falls, MA 01376

U.S. Toll-Free Customer Service: 800-872-0037
Visit us online at www.Mayhew.com
Always wear safety goggles when using hand tools.

Version 2.2016
For the latest version, visit us
online at www.Mayhew.com

The Pros Know

Chisels

Punches

Pry Bars

Handguarded

Specialty

Inspection

Sets and Kits



89032 – 3 Pc. Short Pin Punch Set, Carded



47502 – 3 Pc Nail Set, 1-2-3/32, Carded

Punch Sets

Item	Description	UPC Code	OAL	Body Size	Body Type	Blade Width	Blade Style	Weight (Lbs)	Pkg. Type
89082	3 Pc Punch Set, Carded 24008 – 7/16" Center Punch 1/4" Pt 43502 – 7/32" X 5" Prick Punch 74001 – 5/16" Reg Ec Center Punch	0 81243 89082 5	N/A	N/A	Hex	N/A	N/A	0.48	Carded
62213	4 Pc Knurled Center Punch Kit 24200 – 1/4" Reg Knurled Center Punch 24300 – 5/16" Knurled Center Punch 24301 – 3/8" Knurled Center Punch 24302 – 1/2" Knurled Center Punch	0 45256 62213 2	N/A	N/A	N/A	N/A	N/A	0.44	Pouch
62010	10 Pc Knurled Punch Kit 20501 – 3/32" Reg Knurled Solid Punch 21600 – 1/16" Min Knurled Pin Punch 21601 – 5/64" Min Knurled Pin Punch 21602 – 3/32" Min Knurled Pin Punch 21702 – 3/32" Reg Knurled Pin Punch 21703 – 1/8" Reg Knurled Pin Punch 21704 – 5/32" Reg Knurled Pin Punch 23200 – 5/16" Reg Knurled Prick Punch 24200 – 1/4" Reg Knurled Center Punch 24300 – 5/16" Knurled Center Punch	0 45256 62010 7	N/A	N/A	Round	N/A	N/A	0.55	Pouch
76235	4 Pc Ec Line-Up Punch Kit 72003 – 1/4" Reg Ec Line-Up Punch 72010 – 1/8" Reg Ec Line-Up Punch 72011 – 5/32" Reg Ec Line-Up Punch 72012 – 3/16" Reg Ec Line-Up Punch	0 45256 76235 7	N/A	N/A	Hex	N/A	N/A	1.78	Pouch
47502	3 Pc Nail Set, 1-2-3/32, Carded 26000 – 1/32" Nail Set 26001 – 2/32" Nail Set 26002 – 3/32" Nail Set	0 81243 47502 2	N/A	3/8	Hex	N/A	N/A	0.288	Carded
76065	Ec 5 Pc Long Pin Punch Kit 71500 – 1/8" Reg Ec Pin Punch 71501 – 3/16" Reg Ec Pin Punch 71502 – 1/4" Reg Ec Pin Punch 71503 – 5/16" Reg Ec Pin Punch 71504 – 3/8" Reg Ec Pin Punch	0 45256 76065 0	N/A	N/A	Hex	N/A	Extra Long	1.23	Pouch
76075	Ec 6 Pc Punch Kit 71001 – 3/32" Reg Ec Pin Punch 71002 – 1/8" Reg Ec Pin Punch 71003 – 5/32" Reg Ec Pin Punch 71004 – 3/16" Reg Ec Pin Punch 71005 – 1/4" Reg Ec Pin Punch 71019 – 5/16" Reg Ec Pin Punch	0 45256 76075 9	N/A	N/A	Hex	N/A	N/A	0.88	Pouch
89032	3 Pc Short Pin Punch Set, Carded 42002 – 3/32" X 4-1/2" Pin Punch, Carded 42102 – 1/8" X 4-1/2" Pin Punch, Carded 71000 – 1/16" Reg Ec Pin Punch	0 81243 89032 0	N/A	N/A	Hex	N/A	N/A	0.18	Carded
89052	3 Pc Long Pin Punch Set, Carded 42202 – 1/8" X 6" Long Pin Punch 42402 – 3/16" X 6" Long Pin Punch 42702 – 1/4" X 6" Long Pin Punch	0 81243 89052 8	N/A	N/A	Hex	N/A	N/A	0.47	Carded
62060	8 Pc Knurled Pin Punch Kit 21701 – 1/16" Reg Knurled Pin Punch 21702 – 3/32" Reg Knurled Pin Punch 21703 – 1/8" Reg Knurled Pin Punch 21704 – 5/32" Reg Knurled Pin Punch 21705 – 3/16" Reg Knurled Pin Punch 21706 – 7/32" Reg Knurled Pin Punch 21707 – 1/4" Reg Knurled Pin Punch 21708 – 5/16" Reg Knurled Pin Punch	0 45256 62060 2	N/A	N/A	Round	N/A	N/A	0.75	Pouch

Hook & Pick Sets

Item	Description	UPC Code	OAL	Body Size	Body Type	Blade Width	Blade Style	Weight (Lbs)	Pkg. Type
60003	4 Pc Mini Hook & Pick Set	0 45256 60003 1	N/A	N/A	Round	N/A	N/A	0.32	N/A
60028	4 Pc O-Ring Removal Tool Set	0 45256 60028 4	N/A	N/A	Round	N/A	N/A	0.32	N/A



60003 – 4 Pc Mini Hook & Pick Set



60028 – 4 Pc O-Ring Removal Tool Set

Chisels

Punches

Pry Bars

Handguarded

Specialty

Inspection

Sets and Kits





18 PC Masonry Display

80244 – 18 Pc Brick & Masonry Display

Item	Description	UPC Code	OAL	Body Size	Body Type	Blade Width	Blade Style	Weight (Lbs)	Pkg. Type
80244	18 PC Masonry Display (2 ea) 12300 – 3" Brick Set (2) 12301 – 3.5" Brick Set (2) 12302 – 4" Brick Set (2) 12310 – 2.5" Floor Chisel (2) 12311 – 3" Floor Chisel (2) 30100 – 3/4" x 12" Bullpoint (2) 30200 – 1-3/4" Mason Chisel (2) 30202 – 2-1/4" Mason Chisel (2) 71300 – Rivet Buster (2)	0 45256 80244 2	N/A	N/A	Round	N/A	N/A	22.08	Base

80241 88 PC Punch & Chisel Display

Item	Description	UPC Code	OAL	Body Size	Body Type	Blade Width	Blade Style	Weight (Lbs)	Pkg. Type	
80241	88 Pc Punch & Chisel Display (SAE) (2 each) 70219 – 7/8" x 18" Cold Chisel 70221 – 1" x 12" Cold Chisel 70217 – 7/8" x 12" Cold Chisel 70213 – 3/4" x 12" Cold Chisel 70210 – 5/8" x 12" Cold Chisel 70206 – 1/2" x 9" Cold Chisel 70220 – 1" Cold Chisel 70216 – 7/8" Cold Chisel 70212 – 3/4" Cold Chisel 70209 – 5/8" Cold Chisel 70205 – 1/2" Cold Chisel 70204 – 7/16" Cold Chisel 70202 – 3/8" Cold Chisel 70201 – 5/16" Cold Chisel 70200 – 1/4" Cold Chisel 72003 – 1/4" Line-Up Punch 72012 – 3/16" Line-Up Punch 72011 – 5/32" Line-Up Punch 72010 – 1/8" Line-Up Punch 72021 – 3/32" x 8" Line-Up Punch 70301 – 3/8" x 6-1/2" Solid Punch 70105 – 5/16" x 6" Solid Punch 70003 – 1/4" Solid Punch 70002 – 3/16" Solid Punch 70005 – 5/32" x 5" Solid Punch 70001 – 1/8" Solid Punch 70000 – 3/32" x 5" Solid Punch 70004 – 1/16" x 5" Solid Punch 71105 – 3/8" x 6" Pin Punch 71019 – 5/16" Pin Punch 71005 – 1/4" Pin Punch 71004 – 3/16" Pin Punch 71003 – 5/32" Pin Punch 71002 – 1/8" Pin Punch 71001 – 3/32" Pin Punch 70000 – 1/16" Pin Punch 74004 – 5/8" Center Punch 74003 – 1/2" Center Punch 74002 – 3/8" Center Punch 74001 – 5/16" Center Punch 74000 – 1/4" Center Punch 73002 – 3/8" Prick Punch 73001 – 5/16" x 4-1/2" Prick Punch 73000 – Rivet Buster	0 45256 80241 1	N/A	N/A	N/A	N/A	N/A	N/A	41.1	Plastic Case

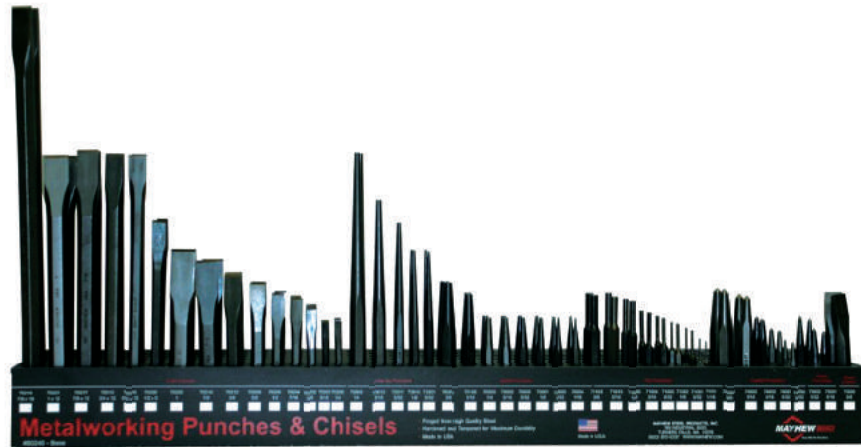

Chisels

Punches

Pry Bars

Handguarded

Specialty

Inspection

Sets and Kits

THE PROS KNOW



Quality. Dependability. Confidence. When the caliber of the tools is just as important as the skills of the professionals employed, businesses trust Mayhew to get the job done. Since 1856, our punches, chisels, and pry bars have been the go-to tools for OEMs and professional mechanics throughout the country. And while our company has grown to meet the needs of the professional market, as well as those of the do-it-yourself automotive enthusiast, our focus has never changed—leveraging our strength to build your business.

Since 1856





Since 1856



MayhewPro:

If this Mayhew hand tool ever fails to provide complete satisfaction, it will be replaced free of charge. Return product to original retailer for replacement.



MayhewSelect:

FOR TWO YEARS from the date of purchase, if this MayhewSelect hand tool ever fails to provide complete satisfaction, it will be replaced free of charge. Return product to original retailer with proof of purchase for replacement.

Exclusions

Warranties do not cover cables and cable assemblies, brass, hollow punches, lights, or batteries, which are expendable parts that can wear out from normal use within the warranty period.

MAYHEW STEEL PRODUCTS, INC.

199 Industrial Blvd.
Turners Falls, MA 01376 U.S.A.

U.S. Toll-Free: 1 800 872-0037
Phone: 1 (413) 863-4860
Fax: 1 (413) 863-8464

www.mayhew.com

ISO 9001:2008 certified

