

FEMALE PLUG M12 STRAIGHT TO MALE PLUG M12 STRAIGHT

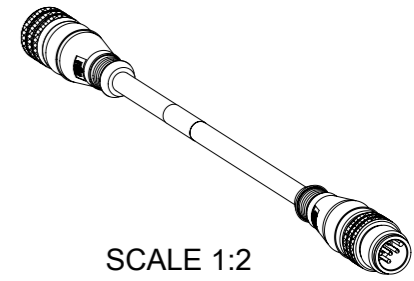
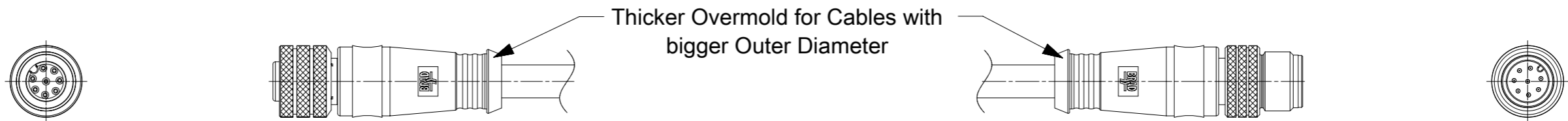
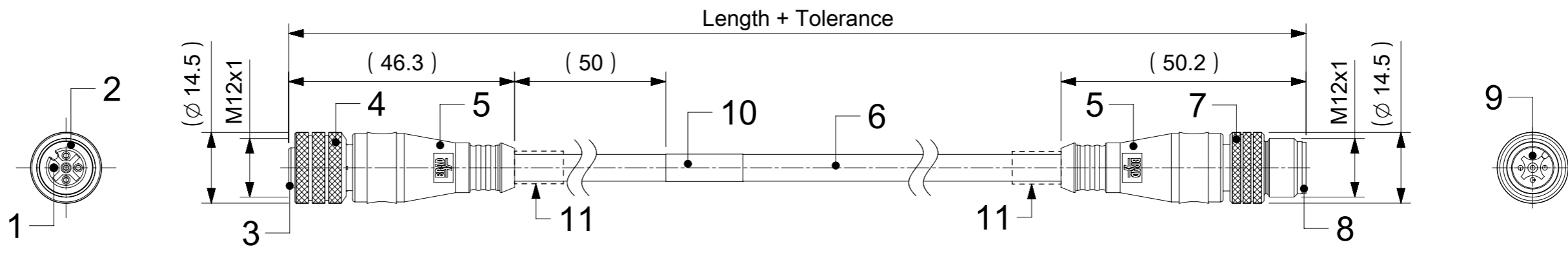

SCALE 1:2

NOTES:

RATED VOLTAGE: 3, 4 contacts 250V per IEC 60664
 5 contacts 60V per IEC 60664
 5 contacts 250V per UL 2238
 8 contacts 30V per IEC 60664
 RATED CURRENT: 3, 4, 5 contacts 4A
 8 contacts 2A

PROTECTION CLASS: IP 67
 TEMPERATURE: -25°C / +85°C
 CONTACTS POSITION FRONT VIEW:

	3 CONTACTS		4 CONTACTS		5 CONTACTS		8 CONTACTS	
FEMALE								
MALE								
CONNECTIONS	PIN	WIRE	PIN	WIRE	PIN	WIRE	PIN	WIRE
	1	BROWN	1	BROWN	1	BROWN	1	WHITE
	2	---	2	WHITE	2	WHITE	2	BROWN
	3	BLUE	3	BLUE	3	BLUE	3	GREEN
	4	BLACK	4	BLACK	4	BLACK	4	YELLOW
			5	---	5	GREY OR GREEN/YELLOW	5	GREY
							6	PINK
							7	BLUE
						8	RED	

CODING REQUIRED TO IEC 61076-2-101

FOR OPTIONS SEE - NUMERICAL CODE - ON SHEET 2

ITEM	QTY.	DESCRIPTION	MATERIAL	FINISH
11	SEE SHEET 2	ID CARRIER	PVC	TRANSPARENT
10	1	LABEL YELLOW	VINYL	---
	-	PRINTING FOR CABLES Ixx	---	---
9	3 / 4 / 5 / 8	CONTACT MALE	SEE PART LIST	SELECTIVE Au OVER Ni
8	1	INSERT MALE BLACK	TPU	---
7	1	COUPLING NUT MALE	---	---
6	-	CABLE	SEE SHEET 2	---
5	-	OVERMOLDING BLACK	TPU	---
4	1	COUPLING NUT FEMALE	---	---
3	1	INSERT FEMALE BLACK	PUR	---
2	1	ORING RED	FPM	---
1	3 / 4 / 5 / 8	CONTACT FEMALE	SEE PART LIST	SELECTIVE Au OVER Ni

THIS DRAWING CONTAINS INFORMATION THAT IS PROPRIETARY TO MOLEX ELECTRONIC TECHNOLOGIES, LLC AND SHOULD NOT BE USED WITHOUT WRITTEN PERMISSION

DIMENSION UNITS	SCALE	CURRENT REV DESC: REMOVED PNS	
mm	1:1		
GENERAL TOLERANCES (UNLESS SPECIFIED)			
ANGULAR TOL	± 1.0°		
4 PLACES	±	EC NO: 615671	
3 PLACES	±	DRWN: MDHARMANTI	2019/04/01
2 PLACES	± 0.05	CHK'D: RSILLER	2019/04/16
1 PLACE	± 0.3	APPR: RSILLER	2019/04/16
0 PLACES	± 0.5	INITIAL REVISION:	
DRAFT WHERE APPLICABLE MUST REMAIN WITHIN DIMENSIONS		DRWN: JMARSZALEK	2016/09/19
THIRD ANGLE PROJECTION		APPR: RSILLER	2016/12/08
DRAWING		SERIES	MATERIAL NUMBER
A3-SIZE		120066	SEE PART LIST
CUSTOMER		DOCUMENT NUMBER	
GENERAL MARKET		1200668165	
SHEET NUMBER		DOC TYPE	DOC PART
1 OF 5		PSD	000
		REVISION	
		A3	

ENGINEERING NO. - NUMERICAL CODE (Available parts see PART LIST table. Other parts available upon request).

OPTIONS

8 8 X 0 3 0 X X X X X X X X

88=Micro-Change
M12x1
Double ended

Contacts:
3=3 Contacts
4=4 Contacts
5=5 Contacts
8=8 Contacts

Heads style:
030=Plug Female Straight
to Plug Male Straight

Cable type: See Table

Units:
M=Meter

Length
Examples:
005=0.5 unit
010=1 unit
100=10 units

Coupling Nut:
Blank (Standard)=Knurled Brass Ni Plated
1=Hexagonal Stainless steel
5=Knurled Derlin
7=Knurled Brass Ni Plated, Teflon Coated
Blank=7 for cables I20, I26, K03, K05, P82, S26
8=Type 316 stainless steel
9=Knurled / Hexagonal Brass Ni Plated SW13

H= 2 pcs. of I/D Carrier PVC Transparent
(Cables Ixx & P82 always with 2 pcs. of I/D Carrier even if no H in Engineering No.)

Overmold color:
Blank (Standard)=Black TPU
Blank=Yellow PVC for cables
A09, S19, S20, S26
Blank=Yellow TPE-E for cables
K03, K05
A=Grey / G=Black / Y=Yellow

COUPLING NUT
FEMALE MALE

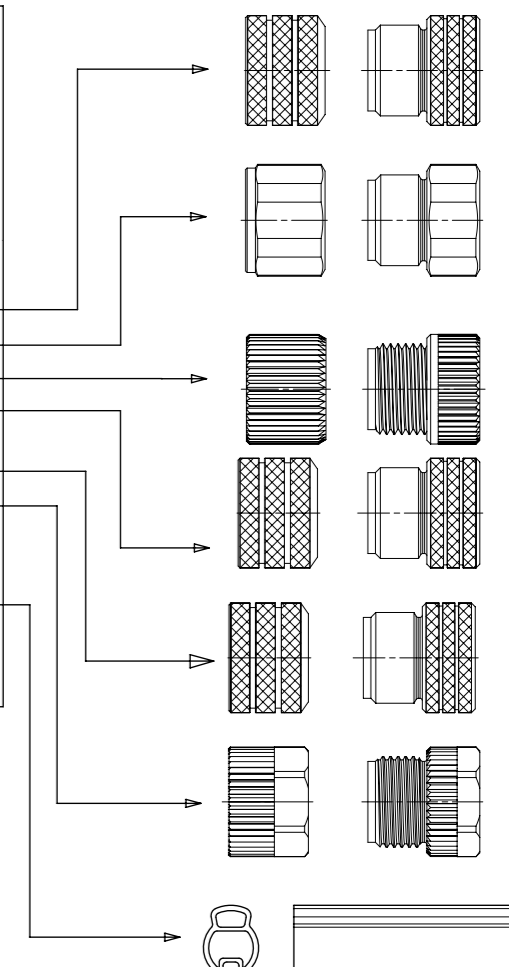

CABLE LENGTH TOLERANCES		
OVER [mm]	UP TO AND INCLUDING [mm]	TOLERANCES [mm]
0	305	+19
305	915	+45
915	1830	+56
1830	3660	+89
3660	7320	+165
7320	14640	+317
14640	30500	+610
30500	>	+2% OF FINISHED LENGTH

THIS DRAWING CONTAINS INFORMATION THAT IS PROPRIETARY TO MOLEX ELECTRONIC TECHNOLOGIES, LLC AND SHOULD NOT BE USED WITHOUT WRITTEN PERMISSION									
DIMENSION UNITS	SCALE	CURRENT REV DESC: REMOVED PNS							
mm	1:1								
GENERAL TOLERANCES (UNLESS SPECIFIED)									
ANGULAR TOL	± 1.0 °	CSE M12 XP AC FE STR MA STR XM DE							
4 PLACES	±	PRODUCT CUSTOMER DRAWING							
3 PLACES	±	DOCUMENT NUMBER							
2 PLACES	± 0.05	1200668165							
1 PLACE	± 0.3	DOC TYPE DOC PART REVISION							
0 PLACES	± 0.5	PSD 000 A3							
DRAFT WHERE APPLICABLE MUST REMAIN WITHIN DIMENSIONS		THIRD ANGLE PROJECTION	DRAWING	SERIES	MATERIAL NUMBER	CUSTOMER		SHEET NUMBER	
			A3-SIZE	120066	SEE PART LIST	GENERAL MARKET		2 OF 5	

CABLE INFORMATION (for more information see Cable Data Sheet).

CABLE TYPE	NO. OF WIRES	CROSS SECTION	CABLE JACKET	UL	CSA	STATIC: TEMP. / BENDING RADIUS	DYNAMIC: TEMP. / BENDING RADIUS	DRAG CHAIN	SHIELD
A09	4	22AWG	PVC YELLOW	UL 2661	I/II A/B 80°C/300V	-	-	-	-
B02	4	18AWG	PUR YELLOW	UL 20549	I/II A/B 80°C/300V	-	-	-	-
E52	3 / 4	0.34mm ²	PVC GREY	-	-	-30°C to +70°C	-5°C to +70°C	-	-
E57	5	0.34mm ²	PVC GREY	-	-	-	-5°C to +70°C	-	-
I02	3 / 4 / 8	0.25mm ²	PVC CEI GREY	-	-	-30°C to +70°C	-5°C to +70°C	-	-
I03	3 / 4 / 5	0.34mm ²	PVC CEI GREY	-	-	-30°C to +70°C	-5°C to +70°C	-	-
I20	3 / 4	0.34mm ²	PVC CEI GREY	-	-	-30°C to +70°C	-5°C to +70°C	-	YES
I26	5	0.34mm ²	PVC CEI GREY	-	-	-30°C to +70°C	-5°C to +70°C	-	YES
K03	4 / 5	18AWG	TPE YELLOW	UL ITC or PLC	I/II A/B 90°C/300V	max 105°C	-	-	-
K05	3 / 4 / 5	22AWG	TPE YELLOW	UL ITC or PLTC	I/II A/B 90°C/300V	max 105°C	-	-	-
P04	4	0.50mm ²	PUR BLACK	-	-	-40°C to +90°C, >7.5xO.D.	-15°C to +90°C, >12.5xO.D.	-	-
P19	8	0.25mm ²	PUR BLACK	-	-	-40°C to +90°C, >7.5xO.D.	-15°C to +90°C, >12.5xO.D.	2 000 000 cycles, >15xO.D.	YES
P20	3 / 4 / 5	0.34mm ²	PUR BLACK LS0H	-	-	-30°C to +80°C	-	-	YES
P82	3 / 4 / 5	0.34mm ²	PUR IRR ORANGE	-	-	-50°C to +105°C, >5xO.D.	-40°C to +105°C, >7.5xO.D.	-	-
S19	8	0.25mm ²	PVC YELLOW	UL 2661/1569	C22.2 II A 105°C/300V	-30°C to +105°C, >10xO.D.	-15°C to +105°C, >15xO.D.	-	YES
S20	3 / 4 / 5	0.34mm ²	PVC YELLOW	UL 2661/1731	C22.2 II A 105°C/300V	-30°C to +105°C	-	-	YES
S26	5	0.34mm ²	PVC YELLOW	UL 2661/1731	C22.2 II A 105°C/300V	-30°C to +105°C	-	-	YES

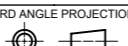
THIS DRAWING CONTAINS INFORMATION THAT IS PROPRIETARY TO MOLEX ELECTRONIC TECHNOLOGIES, LLC AND SHOULD NOT BE USED WITHOUT WRITTEN PERMISSION										
DIMENSION UNITS	SCALE	CURRENT REV DESC: REMOVED PNS								
mm	1:1									
GENERAL TOLERANCES (UNLESS SPECIFIED)		EC NO: 615671					CSE M12 XP AC FE STR MA STR XM DE			
ANGULAR TOL	± 1.0 °	DRWN: MDHARMANTI 2019/04/01								
4 PLACES	±	CHK'D: RSILLER 2019/04/16								
3 PLACES	±	APPR: RSILLER 2019/04/16					PRODUCT CUSTOMER DRAWING			
2 PLACES	± 0.05	INITIAL REVISION:					DOCUMENT NUMBER			
1 PLACE	± 0.3	DRWN: JMARSZALEK 2016/09/19					1200668165			
0 PLACES	± 0.5	APPR: RSILLER 2016/12/08					PSD 000 A3			
DRAFT WHERE APPLICABLE MUST REMAIN WITHIN DIMENSIONS		THIRD ANGLE PROJECTION	DRAWING	SERIES	MATERIAL NUMBER	CUSTOMER	SHEET NUMBER			
			A3-SIZE	120066	SEE PART LIST	GENERAL MARKET	3 OF 5			

PART LIST

No.	Part No.	Engineering No.	Cable Length
171	1200668644	884030P82M0107Y	1m
172	1200668645	884030P82M0207Y	2m
173	1200668696	883030I03M030A	3m
174	1200668697	883030I03M050A	5m
175	1200668698	883030I03M100A	10m
176	1200668699	883030I03M200A	20m
177	1200668735	884030P82M0707Y	7m
178	1200668736	885030I26M015Y	1.5m
179	1200668773	885030P82M0107	1m
180	1200668873	885030I26M050Y	5m
181	1200669113	884030A09M0308	3m
182	1200669118	884030P82M0307Y	3m
183	1200669149	883030I03M010Y	1m
184	1200669218	885030I03M100Y	10m
185	1200669227	884030K05M500	50m
186	1200669228	884030K05M600	60m
187	1200718014	884030P82M0607	6m
188	1200660166	883030A09M010	1m
189	1200660261	884030A09M005	0.5m
190	1200660262	884030A09M006	0.6m
191	1200660266	884030A09M010	1m
192	1200660269	884030A09M015	1.5m
193	1200660294	884030A09M080	8m
194	1200660299	884030A09M1008	10m

No.	Part No.	Engineering No.	Cable Length
195	1200660434	885030A09M050	5m
196	1200661037	885030K03M040	4m
197	1200661039	885030K03M060	6m
198	1200661041	885030K03M080	8m
199	1200661684	885030K03M300	30m
200	1200661686	885030K03M180	18m
201	1200661687	885030K03M230	23m
202	1200668081	885030E57M100A	10m
203	1200668293	883030D02M005	0.5m

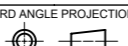
THIS DRAWING CONTAINS INFORMATION THAT IS PROPRIETARY TO MOLEX ELECTRONIC TECHNOLOGIES, LLC AND SHOULD NOT BE USED WITHOUT WRITTEN PERMISSION										
DIMENSION UNITS	SCALE	CURRENT REV DESC: REMOVED PNS								
mm	1:1									
GENERAL TOLERANCES (UNLESS SPECIFIED)		EC NO: 615671					CSE M12 XP AC FE STR MA STR XM DE			
ANGULAR TOL	± 1.0 °	DRWN: MDHARMANTI 2019/04/01								
4 PLACES	±	CHK'D: RSILLER 2019/04/16								
3 PLACES	±	APPR: RSILLER 2019/04/16					PRODUCT CUSTOMER DRAWING			
2 PLACES	± 0.05	INITIAL REVISION:					DOCUMENT NUMBER			
1 PLACE	± 0.3	DRWN: JMARSZALEK 2016/09/19					1200668165			
0 PLACES	± 0.5	APPR: RSILLER 2016/12/08					PSD 000 A3			
DRAFT WHERE APPLICABLE MUST REMAIN WITHIN DIMENSIONS	THIRD ANGLE PROJECTION	DRAWING	SERIES	MATERIAL NUMBER	CUSTOMER	SHEET NUMBER				
		A3-SIZE	120066	SEE PART LIST	GENERAL MARKET	5 OF 5				

DOCUMENT STATUS	P1	RELEASE DATE	2019/04/16	15:06:12
-----------------	----	--------------	------------	----------

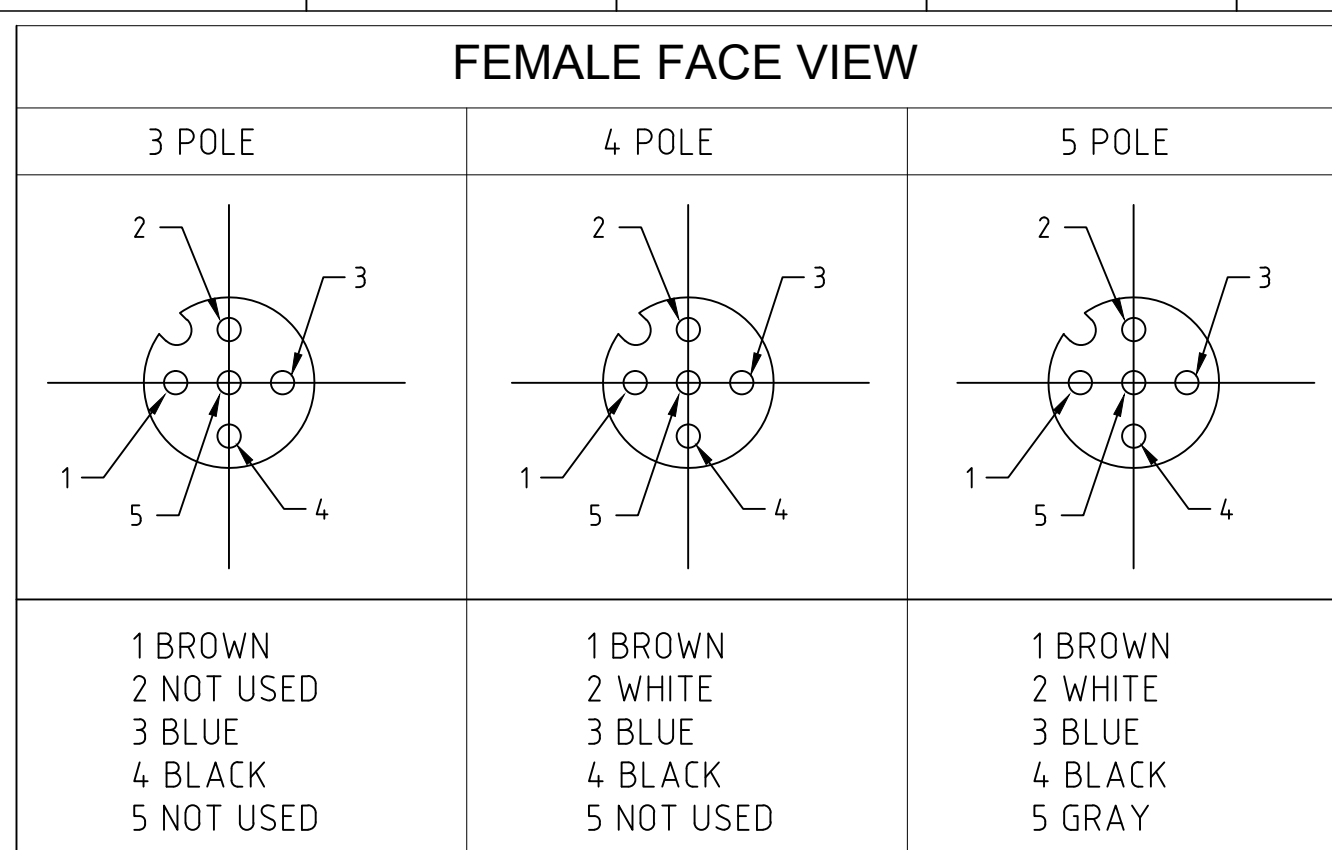

PART NO.	ENGINEERING NO.	FINISHED LENGTH	POLES	CABLE DIA.
1200660677	883030K05M020	2.0M [6'7"]	3	.20/5.1
1200660691	884030K05M040	4.0M [13'1"]	4	.21/5.3
1200662133	885030K05M100	10.0M [32'10"]	5	.23/5.8

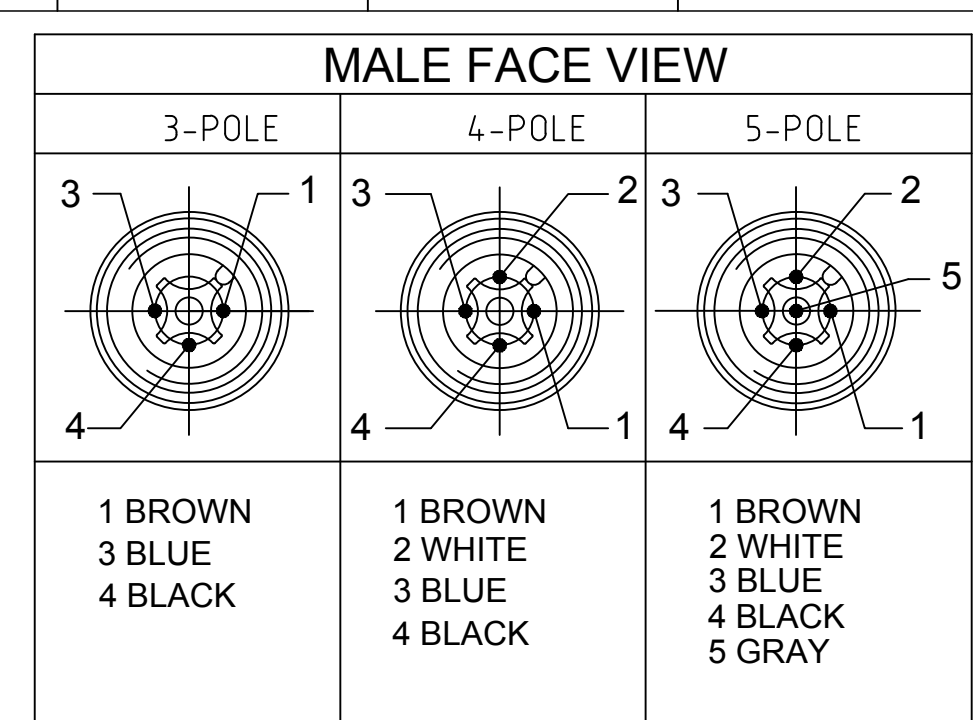

(B) PART NO. LEGEND
883030K05M020

POLES: 3,4 & 5

CABLE TYPE
 22AWG
 TPE YELLOW

FINISHED LENGTH
 M005 = 0.5 Meters
 M010 = .0 Meter
 M100 = 10 Meters

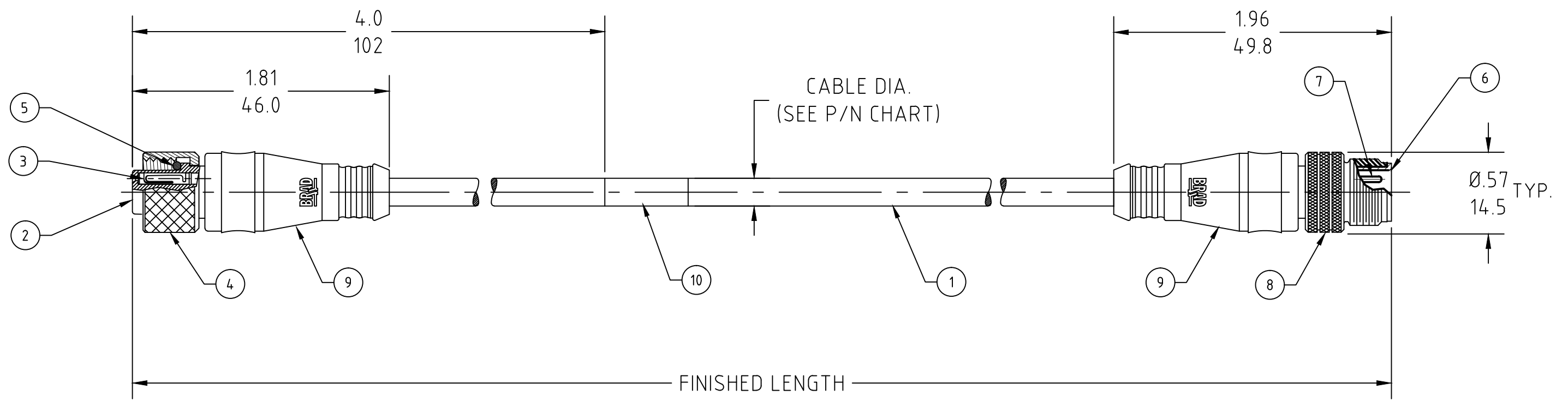

- (B) NOTES:**
1. MATERIAL: AS NOTED
 2. FINISH: AS NOTED
 3. ELECTRICAL:
 VOLTAGE: 250V
 CURRENT: 4A
 4. TEMP RATING: -25°TO +105°C
 5. PROTECTION: IP67 (WHEN MATED)
 6. COUPLING THREAD: M12 X 1
 7. UL RECOGNIZED FILE: E152210
 CSA CERTIFIED FILE: LR6837
 8. ALL DIMS ARE FOR REFERENCE
 UNLESS NOTED OTHERWISE

(B) CABLE FLEX CHARACTERISTICS

TORSIONAL FLEX TEST	10 MILLION CYCLES PER MIL-C-13777G
BEND FLEX TEST	10 MILLION CYCLES PER MIL-C-13777G
WELD SLAG RESISTANCE	WOODHEAD STANDARD S-300

(B) CABLE LENGTH TOLERANCES

>.3M [1FT]: +19mm-0 [+ .75in-0]
.3 - .9M [1 - 3FT]: +44.5mm-0 [+1.75in-0]
.9 - 1.8M [3 - 6FT]: +55.6mm-0 [+2.19in-0]
1.8 - 3.7M [6 - 12FT]: +88.9mm-0 [+3.50in-0]
3.7 - 7.3M [12 - 24FT]: +165.1mm-0 [+6.50in-0]
7.3-14.6M [24 - 48FT]: +317.5mm-0 [+12.50in-0]
14.6 - 30.5M [48-100FT]: +622.3mm-0 [+24.50in-0]
OVER 30M [100FT] +2% OF FINISHED LENGTH

ITEM	DESCRIPTION	MATERIAL	FINISH
10	WRAP LABEL	VINYL	BLACK/YELLOW
9	OVERMOLD	TPE	YELLOW
8	COUPLING NUT	BRASS	NICKEL PLATED
7	CONTACT PIN	COPPER ALLOY	GOLD PLATED
6	MALE INSERT	PUR	BLACK
5	O-RING	VITON	RED
4	COUPLING NUT	BRASS	NICKEL PLATED
3	CONTACT SOCKET	COPPER ALLOY	GOLD PLATED
2	FEMALE INSERT	PUR	BLACK
1	CABLE, 22AWG, 300V, 105°	TPE JACKET	YELLOW

RELEASED EC NO: ICG2019-0231 DRWN: RSTONE CHKD: M ZIELIN APPR: BWOODMAN2010/01/29	11/6/18 DESCRIPTION	QUALITY SYMBOL ▽=0 ▽=0	GENERAL TOLERANCES (UNLESS SPECIFIED) <table style="width: 100%;"> <thead> <tr> <th></th> <th>mm</th> <th>INCH</th> </tr> </thead> <tbody> <tr> <td>4 PLACES</td> <td>±---</td> <td>±---</td> </tr> <tr> <td>3 PLACES</td> <td>±---</td> <td>±---</td> </tr> <tr> <td>2 PLACES</td> <td>±---</td> <td>±---</td> </tr> <tr> <td>1 PLACE</td> <td>±---</td> <td>±---</td> </tr> </tbody> </table>		mm	INCH	4 PLACES	±---	±---	3 PLACES	±---	±---	2 PLACES	±---	±---	1 PLACE	±---	±---	DIMENSION STYLE IN/MM DRAWN BY: LSTEMMLE DATE: 2010/01/25 CHECKED BY: RE DATE: 2010/01/26 APPROVED BY: NSTAUDIG DATE: 2010/01/29	SCALE: --- DESIGN UNITS: INCH THIRD ANGLE PROJECTION
		mm	INCH																	
	4 PLACES	±---	±---																	
	3 PLACES	±---	±---																	
2 PLACES	±---	±---																		
1 PLACE	±---	±---																		
DRAFT WHERE APPLICABLE MUST REMAIN WITHIN DIMENSIONS			THIS DRAWING CONTAINS INFORMATION THAT IS PROPRIETARY TO MOLEX INCORPORATED AND SHOULD NOT BE USED WITHOUT WRITTEN PERMISSION	TITLE MICRO-CHANGE CORDSET 3/4/5 P. FE STR/ MA STR 22/3-5 YELLOW TPE CABLE																
			MOLEX INCORPORATED DOCUMENT NO.: SD-120066-011 SHEET NO.: 1 OF 1																	