

FEATURED MODEL

441023 1-3/4 Bowl, 9" & 7" bowl depths

ADDITIONAL MODELS

441261 1-3/4 Reverse Bowl, 7" & 9" bowl depths

FEATURES

- Required outside cabinet: 36"
- 18 gauge, 304 series stainless steel
- Premium 18/10 chrome/nickel content
- Refined Brush Finish (RBF)
- Rear drain placement
- Design allows for easy installation in standard 25" countertop
- Sound deadening insulation and pads

OPTIONAL ACCESSORIES

Stainless Steel Sink Grid Large: 515300

Stainless Steel Sink Grid Small: 515297

Undermount Sink Clips: 440851

CODE/STANDARDS COMPLIANCE

ASME 112.19.3-00

IAPMO/UPC listed



NOMINAL DIMENSIONS

Model 441023 shown

OVERALL	BOWL DEPTHS		DRAIN
	LEFT	RIGHT	
32-3/8" x 20-1/2"	9"	7"	3-1/2"

DXF cutout templates available on our website.

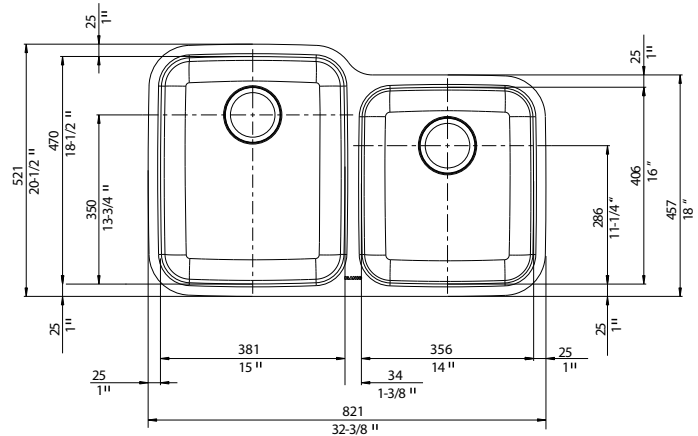

WARRANTY

Blanco America's Stainless Steel sinks feature a LIMITED LIFETIME WARRANTY to be free of all manufacturing defects under normal use. See our complete warranty for details.

While Blanco America endeavors to provide accurate information, all dimensions are nominal, cannot be guaranteed, and are subject to change or cancellation. Blanco America assumes no responsibility for use of superseded or voided specifications.

JOB INFORMATION

Job Name: _____

Contact: _____

Date Specified: _____

Specifier: _____

Contractor: _____

BLANCO AMERICA

800.451.5782

www.blancoamerica.com

© 2015 BLANCO AMERICA

4/15

SPEC-004