

# SELECTION/DIMENSIONS

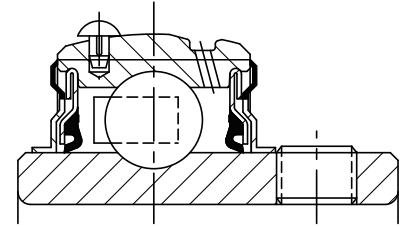

## Setscrew Ball Bearings SC NORMAL DUTY CYLINDRICAL UNITS

Lube Fitting Thread Size:  
1/4-28 tapered thread

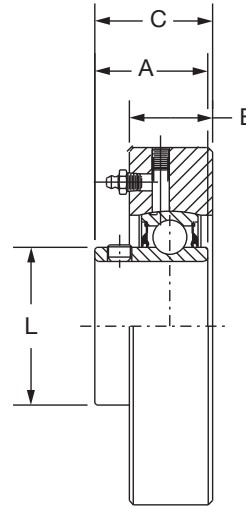
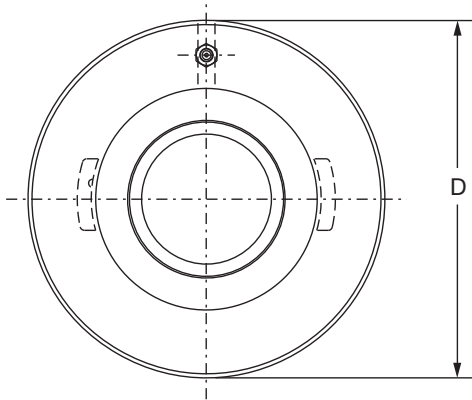

Series	Shaft Size	Part No.	Description
205	7/8	<b>124394</b>	CYL-SC-014
	15/16	<b>124148</b>	CYL-SC-015
	1	<b>124149</b>	CYL-SC-100
206	1-1/16	<b>124427</b>	CYL-SC-101
	1-1/8	<b>124428</b>	CYL-SC-102
	1-3/16	<b>124250</b>	CYL-SC-103
	1-1/4	<b>123177</b>	CYL-SC-104S
207	1-1/4	<b>124251</b>	CYL-SC-104
	1-5/16	<b>124429</b>	CYL-SC-105
	1-3/8	<b>124430</b>	CYL-SC-106
	1-7/16	<b>124253</b>	CYL-SC-107

Series	Shaft Size	Weight lbs.	A	B	C	D	L
205	7/8	1.4	1.34	0.84	1.19	3.125/3.123	1.32
	15/16	1.3					
	1	1.2					
206	1/16	2.2	1.52	0.94	1.38	3.500/3.498	1.57
	1/8	2.1					
	1-3/16	2.0					
	1-1/4	1.9					
207	1-1/4	2.8	1.71	1.06	1.54	3.875/3.873	1.84
	1-15/16	2.7					
	1-3/8	2.6					
	1-7/16	2.5					

FEATURES/BENEFITS PAGE B4-3	HOW TO ORDER/NOMENCLATURE PAGE B4-5	SELECTION PAGE B4-6	ACCESSORIES PAGE B4-98
--------------------------------	--	------------------------	---------------------------