



**GENERAL DESCRIPTION:**

Exposed, sensor-operated Selectronic® Toilet Flush Valve for floor-mounted or wall-hung 1-1/2" top spud flushometer bowls. CR-P2 lithium battery powered.

**PRODUCT FEATURES:**

- **Factory-Installed CR-P2 Lithium Battery**
- **Self-Cleaning Piston** with integral wiper spring significantly reduces clogging and maintenance
- **Selectronic® Proximity System** with universal sensor provides hygienic, "hands free" operation
- **State-of-the-Art Electronics** prevent ghost flushing
- **Dezincification Resistant** semi-red brass alloy
- **Fully Mechanical Manual Override Button** can flush the valve without power
- **Fail-Safe:** Valve automatically closes upon loss of power or water pressure and does not need to be reset
- **Adjustable Sanitary Flush** cleans the fixture & maintains the trap seal.
- **Stadium Feature:** Valve automatically switches to water savings mode during periods of heavy usage
- **Chemical Resistant EPDM Seals** for extended life
- **High Back Pressure Vacuum Breaker**
- **Adjustable Tailpiece**
- **Range can be adjusted manually or with optional remote control**
- **No external volume adjustment.**
- **Can be installed left or right handed**

**MODEL NUMBER:**

- ❑ **6065.161.002** Exposed, sensor-operated flush valve for 1-1/2" top spud flushometer bowls, 1.6 gpf.

Inlet includes 1" sweat solder kit and angle stop with back flow protection and vandal-resistant cap.

Outlet includes 1-1/2" high back pressure vacuum breaker with spud coupling and flange.

- ❑ **6065.565.002** Retrofit Valve Only, 1.6 gpf

**OPERATING PRESSURE:**

25 psi (flowing) - 80 psi (static)

**FLOW REQUIREMENT:**

25 gpm (94.6 L/min.)

**BATTERY LIFE:**

4 years

**OPTIONAL ACCESSORIES:**

- Cast wall flanges: 1" (6065.810) & 1-1/2" (6065.815)
- Solid ring pipe supports: 2-1/2" C-E (6065.821) & 6" C-E (6065.861)
- Split ring pipe supports: 2-1/2" C-E (6065.822) & 6" C-E (6065.862)

**TYPICAL WATER CLOSET INSTALLATION:  
AFWALL™ TOILET SHOWN**

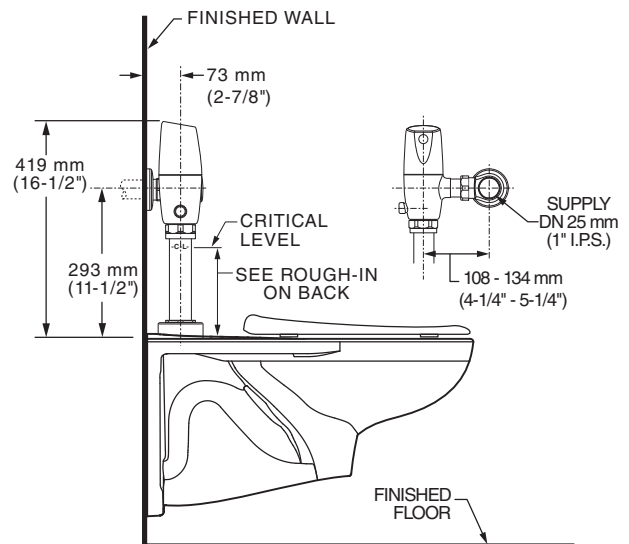

**RECOMMENDED SPECIFICATION:**

Electronic, sensor activated toilet flush valve shall feature self-cleaning piston valve with integral wiper spring in refill orifice to prevent clogging. Includes a factory-installed CR-P2 lithium battery and fully mechanical manual override that can flush the valve without power. Includes semi-red brass valve body and metal cover with chrome finish. Includes angle stop with back-flow protection & vandal-resistant cap. Sweat solder kit and high back pressure vacuum breaker also included. 1.6 gpf / 6.0 Lpf flush valve shall be American Standard Model # 6065.161.002.

**LISTINGS:**

- ASSE 1037
- ANSI/ASME A112.19.2
- ADA Compliant

**Roughing-in Dimensions**

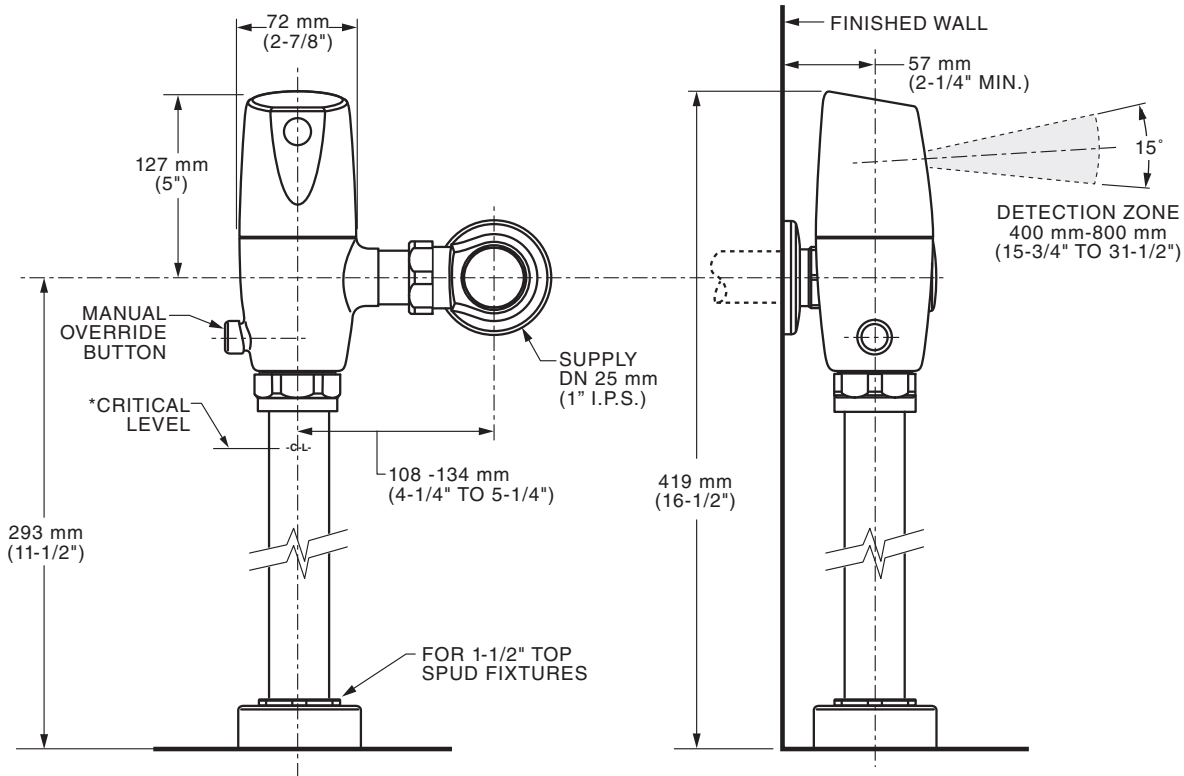

\*Note: The Critical Line (-C-L-) on Vacuum Breaker must typically be 6" (152 mm) above fixture. Consult Codes for details.

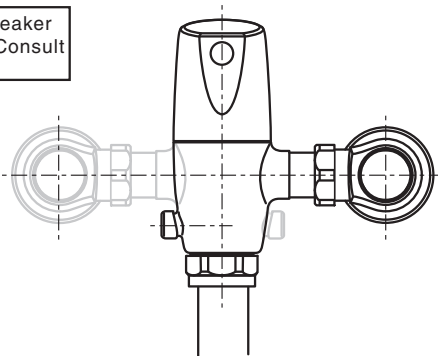

**Right or Left Hand Installation**