



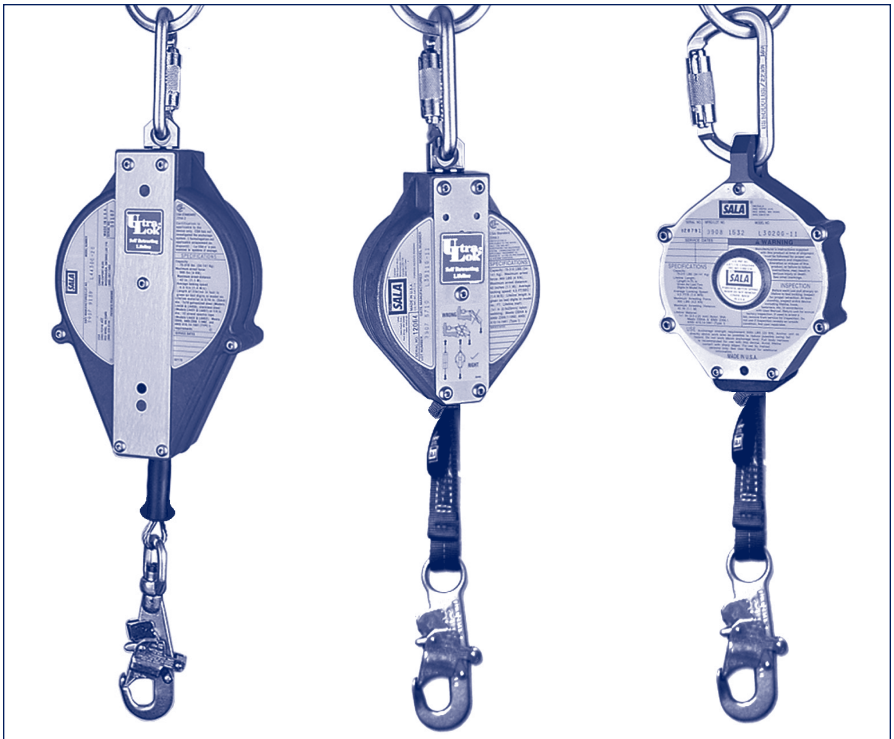
**Instructions for the following series products:**

- Ultra-Lok Wire Rope and Synthetic Rope SRLs
- Aerospace Style SRLs
- Ultra-Lok Web Style SRLs
- Leading Edge SRLs
- Aluminum Housing Model Web Style SRLs
- Aluminum Housing Model Wire Rope Style SRLs

(See back pages for specific model numbers.)

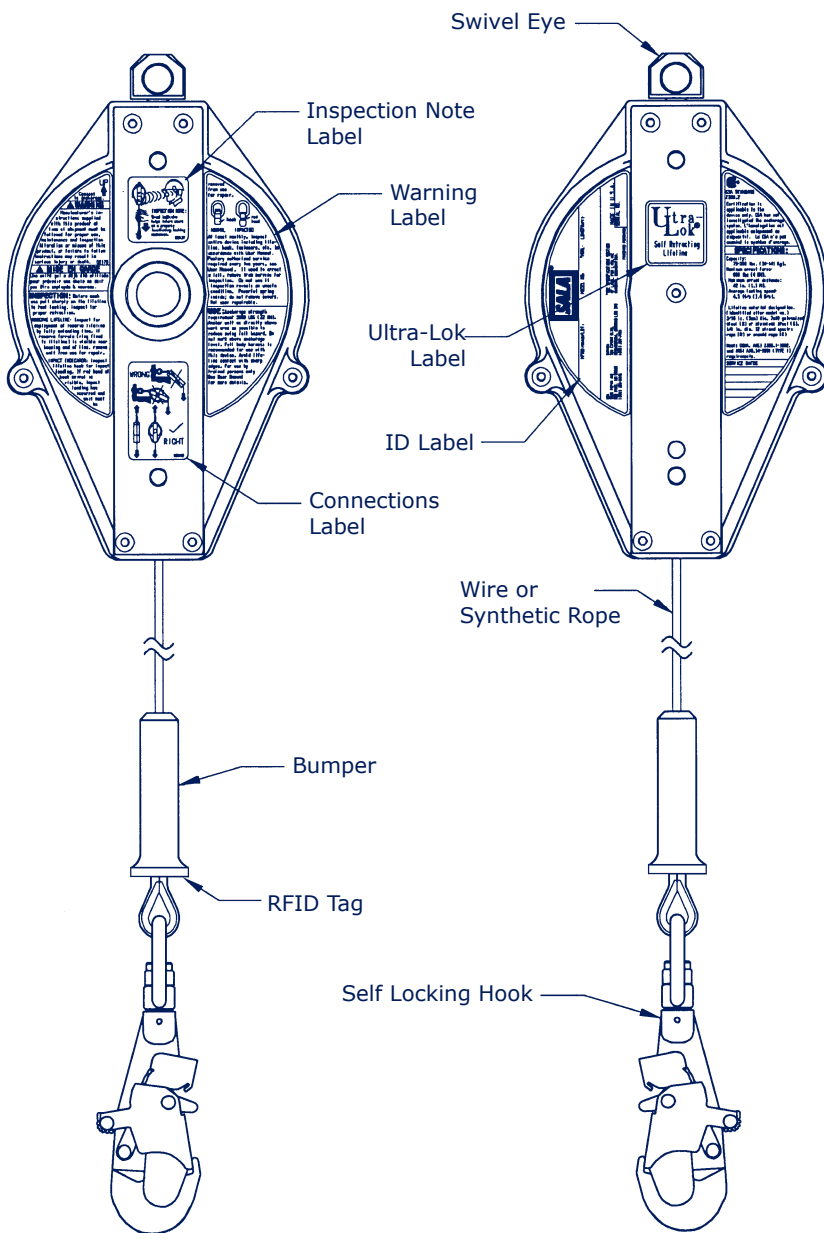
**USER INSTRUCTION MANUAL  
SELF RETRACTING LIFELINES**

*This manual is intended to meet the Manufacturer's Instructions as required by ANSI Z359.1 and the Canadian Standards Association, and should be used as part of an employee training program as required by OSHA.*

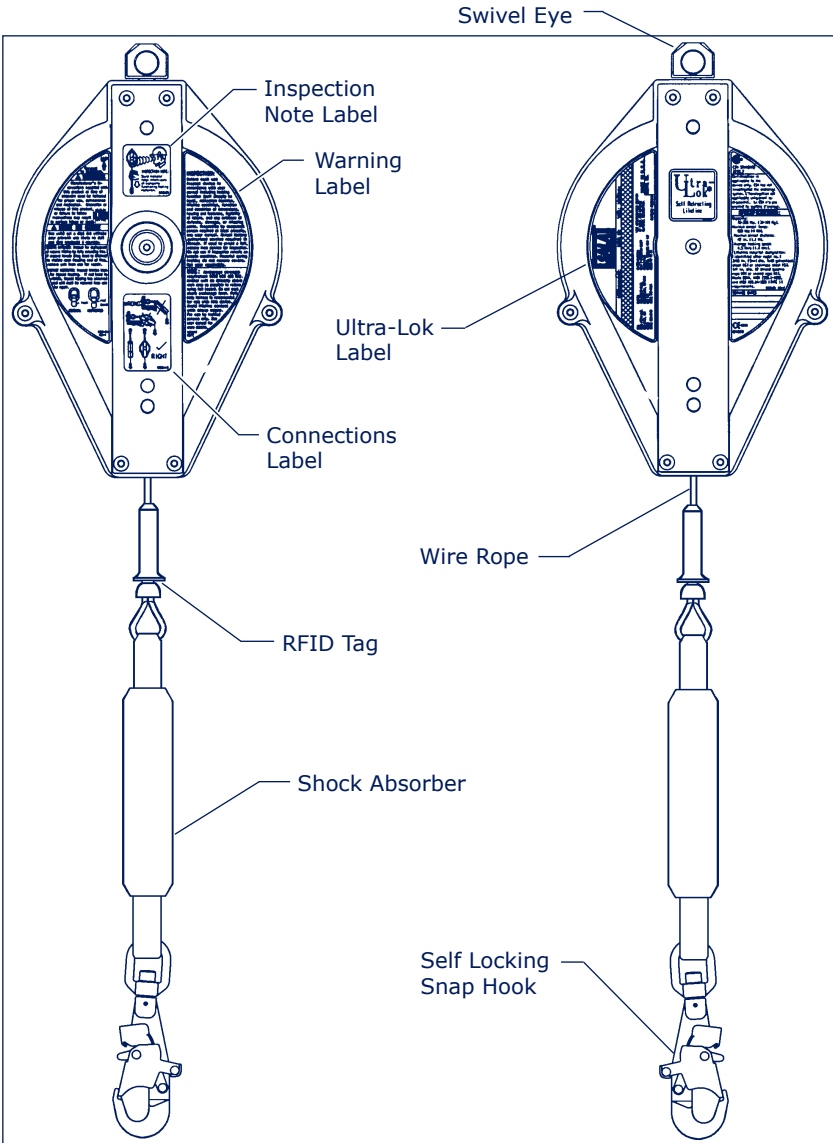




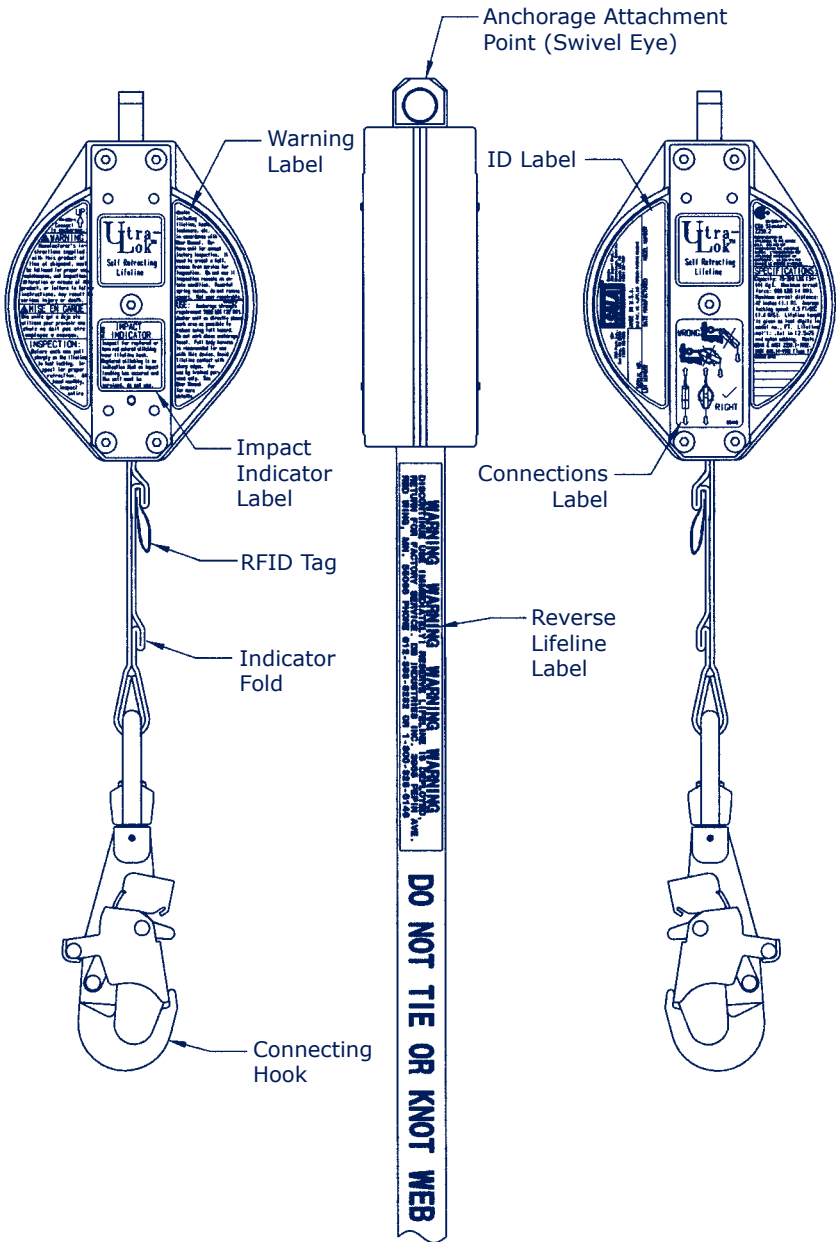
**Figure 1 - Ultra-Lok Models, Wire and Synthetic Rope Styles**



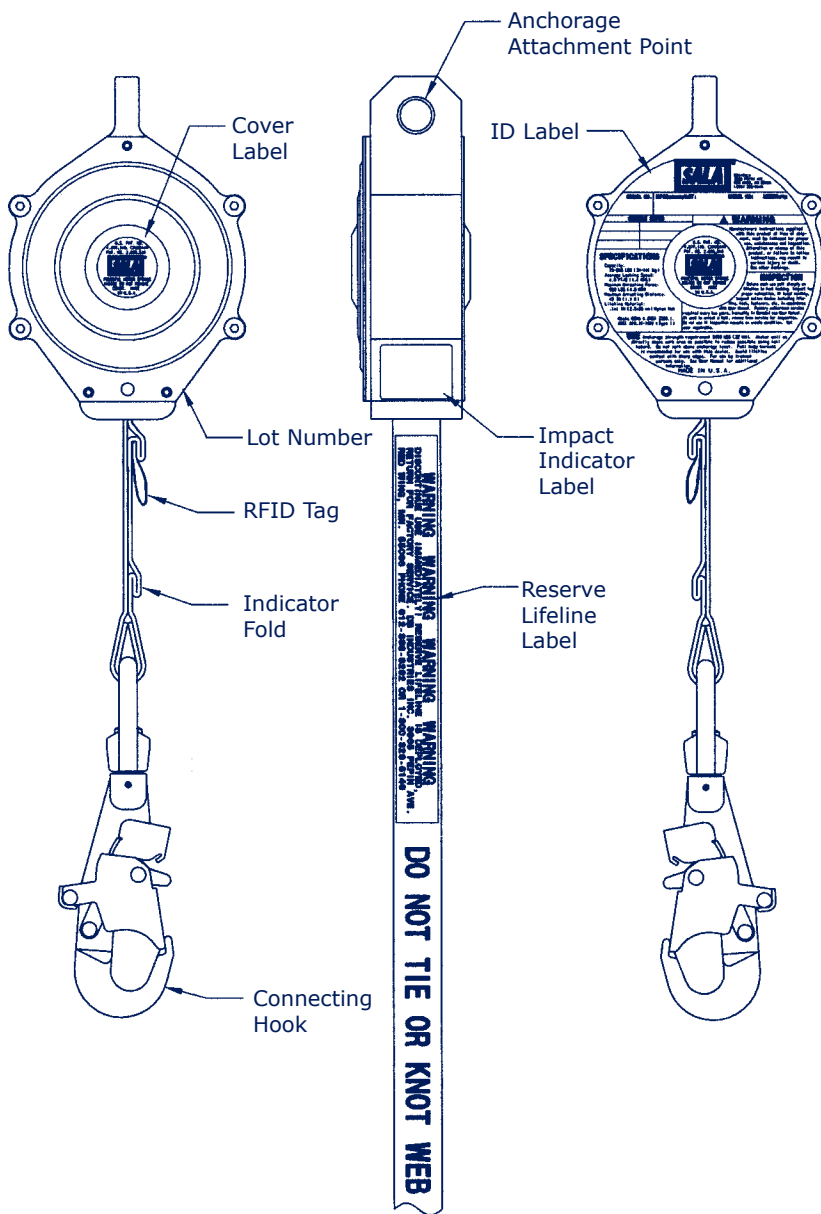
**Figure 2 - Leading Edge SRL**



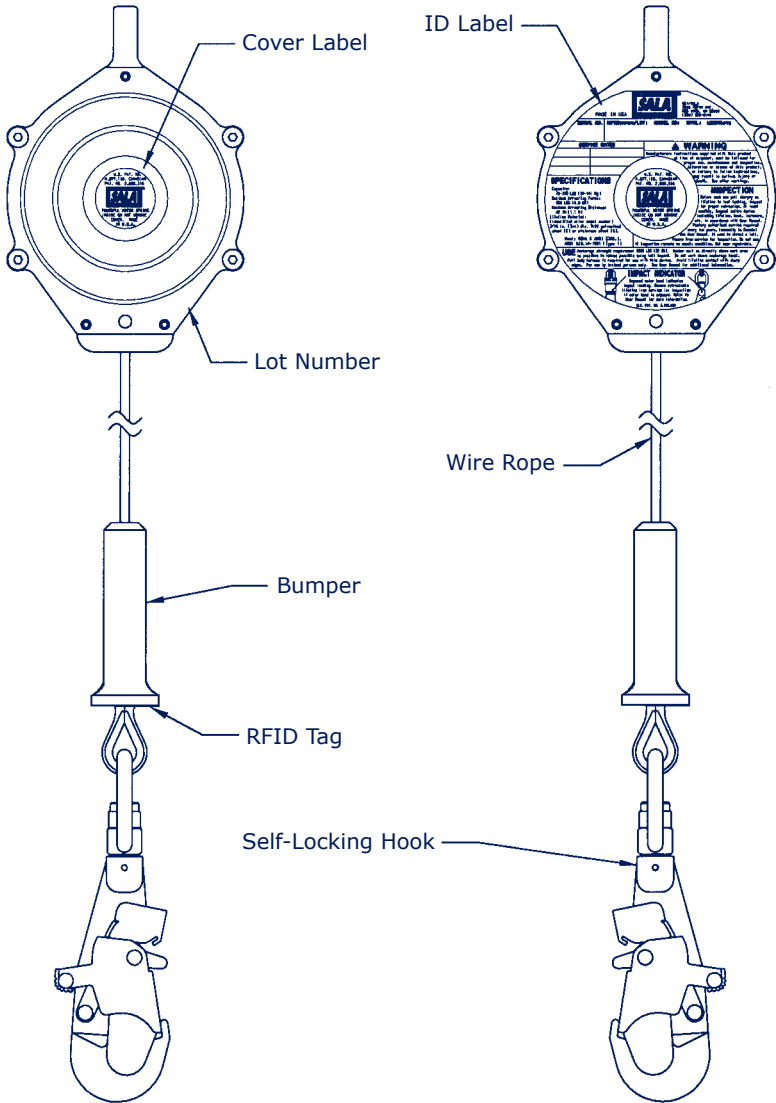
**Figure 3 - Ultra-Lok Models, Web Style**



**Figure 4 -Aluminum Housing Models, Web Style**



**Figure 5 -Aluminum Housing Models, Wire Rope Style**



**WARNING:** *This product is part of a personal fall arrest system. The user must read and follow the manufacturer's instructions for each component of the system. These instructions must be provided to the user of this equipment. The user must read and understand these instructions before using this equipment. Manufacturer's instructions must be followed for proper use and maintenance of this equipment. Alterations or misuse of this equipment, or failure to follow instructions, may result in serious injury or death.*

**IMPORTANT:** *If you have questions on the use, care, application, or suitability of this safety equipment, contact DBI-SALA.*

**IMPORTANT:** *Before using this equipment, record the product identification information from the ID label in the inspection and maintenance log in section 9.0 of this manual.*

## **DESCRIPTIONS**

**ULTRA-LOK® WIRE & SYNTHETIC ROPE STYLE SELF RETRACTING LIFELINES:** Includes swivel eye anchorage, self-locking swivel snap hook with impact indicator, and choice of galvanized wire rope lifeline or stainless steel wire rope lifeline in lengths of 20, 30, 50 and 85 feet, or synthetic rope lifeline in lengths of 20, 35 and 55 feet. See Figure 1.

**AEROSPACE SELF RETRACTING LIFELINES:** Includes swivel eye anchorage, stainless steel self-locking swivel snap hook with impact indicator, and 30-foot stainless steel wire rope lifeline. Contains no zinc or cadmium. See Figure 1.

**LEADING EDGE SELF RETRACTING LIFELINES:** Includes swivel eye anchorage, self-locking swivel snap hook with impact indicator, integral shock pack, and 30-foot or 55-foot galvanized wire rope lifeline. See Figure 2.

**ULTRA-LOK® WEB STYLE SELF RETRACTING LIFELINES:** Includes swivel eye anchorage, self-locking snap hook, and 1-inch wide nylon web lifeline in lengths of 11 and 20 feet. See Figure 3.

**ALUMINUM HOUSING WEB STYLE SELF RETRACTING LIFELINES:** Includes a lightweight, heavy duty, extruded aluminum housing, self-locking snap hook, and 1-inch wide nylon web lifeline in a length of 11 feet. See Figure 4.

**ALUMINUM HOUSING WIRE ROPE STYLE SELF RETRACTING LIFELINES:** Includes a lightweight, heavy duty, extruded aluminum housing, self-locking swivel snap hook with impact indicator, and choice of galvanized wire rope lifeline or stainless steel wire rope lifeline in a length of 11 feet. See Figure 5.



## 1.0 APPLICATIONS

**1.1 PURPOSE:** DBI-SALA self retracting lifelines (SRL) are components in personal fall arrest systems (PFAS). They are to be used in situations where worker mobility and fall protection is needed (inspection work, general construction, maintenance work, oil production, confined space work, etc.) DBI-SALA 3504500 and 3504600 Self Retracting Lifelines are designed for use in applications where falls may occur over an edge, such as roofing, leading edge construction, etc. These models are especially suited for use with fall arrest systems using DBI-SALA anchorage connectors intended for leading edge work, such as 2105500 Leading Edge Tripod Anchor, 2103675 Standing Seam Roof Anchor, 2105683 Swiveling Roof Anchor, etc.

**A. FALL ARREST:** The SRL is used as part of a complete fall arrest system. Such systems typically include a full body harness, anchorage connector (i.e. carabiner) and the SRL. This type of system is used where a fall hazard exists.

**1.2 LIMITATIONS:** The following application limitations must be considered before using this product:

**A. CORROSION:** Do not leave this equipment for long periods in environments where corrosion of metal parts could take place as a result of vapors from organic materials. Use caution when working around sewage or fertilizer because of their high concentration of ammonia, which is very corrosive. Use near seawater or other corrosive environments may require more frequent inspections or servicing to ensure corrosion damage is not affecting the performance of the product.

**B. CHEMICAL HAZARDS:** Solutions containing acid or caustic chemicals, particularly at elevated temperatures, may damage DBI-SALA SRLs. When working with such chemicals, frequent inspection of the entire SRL must be completed. Chemical damage to the lifeline is difficult to detect and it is recommended that the lifeline be replaced periodically to ensure safety. The lifeline must be replaced by an authorized service agent. Consult DBI-SALA if in doubt about using this equipment around chemical hazards.

**C. HEAT:** This equipment is not designed for use in high temperature environments. Provide protection for this equipment when using near welding, metal cutting, or similar activities. Hot sparks may burn or damage this equipment. Contact DBI-SALA for details on use of this equipment in high temperature environments.

**NOTE:** Synthetic rope lifelines are not flame proof and must not be exposed to extreme heat. Spectra rope SRLs must not be used in environments or contact surfaces exceeding 140° F (60°C). Vectran rope SRLs must not be used in environments or contact surfaces exceeding 248° F (120°C). Technora rope SRLs must not be used in environments or contact surfaces exceeding 392° F (200°C).

- D. ELECTRICAL HAZARDS:** For web and synthetic rope models, there is a possibility of moisture absorption by the lifeline. Moisture absorbed by the lifeline may provide a path for electrical current to flow, resulting in electrical shock. Use caution when the lifeline may contact high voltage power lines. For wire rope models, there is a possibility of electric current flowing through the lifeline. Use caution where the lifeline may contact high voltage power lines.
- E. CAPACITY:** The SRL is for use by persons with a combined weight (person, clothing, tools, etc.) of 75 lbs. minimum and 310 lbs. maximum. No more than one person can connect to an SRL.

**NOTE:** The 11 ft web Ultra-Lok - models 3103107 and 3103108 only - have a combined weight capacity of 420 lbs.

- F. LOCKING SPEED:** Situations which do not allow for an unobstructed fall path should be avoided. Working in confined or cramped spaces may not allow sufficient speed to cause the SRL to lock in a fall. Working on slowly shifting materials, such as sand or grain, may not allow sufficient speed to cause the SRL to lock. A similar situation may occur on low pitched roofs, where a worker may slide instead of fall. A clear path is required to ensure positive locking of the SRL.
- G. NORMAL OPERATION:** Normal operation will allow the full length of the lifeline to extend and retract with no hesitation when extending and no slack when retracting as the worker moves at normal speeds. If a fall occurs, a speed sensing brake system will activate, stopping the fall and absorbing much of the energy created. For falls that occur near the end of the lifeline travel, the reserve lifeline system will ensure a reduced impact fall arrest. If a fall has been arrested, the SRL must be taken out of service and inspected. See section 5.0. Sudden or quick movements should be avoided during the normal work operation, as this may cause the SRL to lock-up.
- H. TRAINING:** This equipment must be installed and used by persons trained in its correct application and use.
- 1.3** Refer to national standards, including ANSI Z359.1, and applicable local, state, and federal (OSHA) requirements governing this

equipment for more information on personal fall arrest systems and associated system components.

## 2.0 SYSTEM REQUIREMENTS

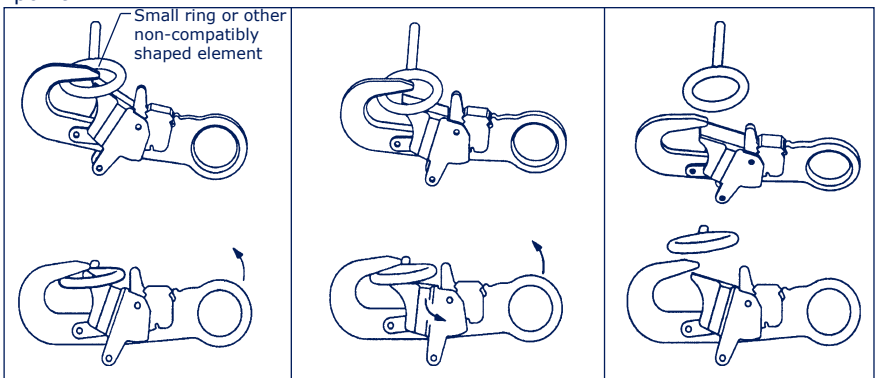
**2.1 COMPATIBILITY OF COMPONENTS:** DBI-SALA equipment is designed for use with DBI-SALA approved components and subsystems only. Substitutions or replacements made with non-approved components or subsystems may jeopardize compatibility of equipment and may effect the safety and reliability of the complete system.

**2.2 COMPATIBILITY OF CONNECTORS:** Connectors are considered to be compatible with connecting elements when they have been designed to work together in such a way that their sizes and shapes do not cause their gate mechanisms to inadvertently open regardless of how they become oriented. Contact DBI-SALA if you have any questions about compatibility.

Connectors (hooks, carabiners, and D-rings) must be capable of supporting at least 5,000 lbs. (22.2 kN). Connectors must be compatible with the anchorage or other system components. Do not use equipment that is not compatible. Non-compatible connectors may unintentionally disengage. See Figure 6. Connectors must be compatible in size, shape, and strength. Self locking snap hooks and carabiners are required by ANSI Z359.1 and OSHA.

**Figure 6 - Unintentional Disengagement (Roll-out)**

If the connecting element that a snap hook (shown) or carabiner attaches to is undersized or irregular in shape, a situation could occur where the connecting element applies a force to the gate of the snap hook or carabiner. This force may cause the gate (of either a self-locking or a non-locking snap hook) to open, allowing the snap hook or carabiner to disengage from the connecting point.



**2.3 MAKING CONNECTIONS:** Only use self-locking snap hooks and carabiners with this equipment. Only use connectors that are suitable to each application. Ensure all connections are compatible in size, shape, and strength. Do not use equipment that is not compatible. Ensure all connectors are fully closed and locked.

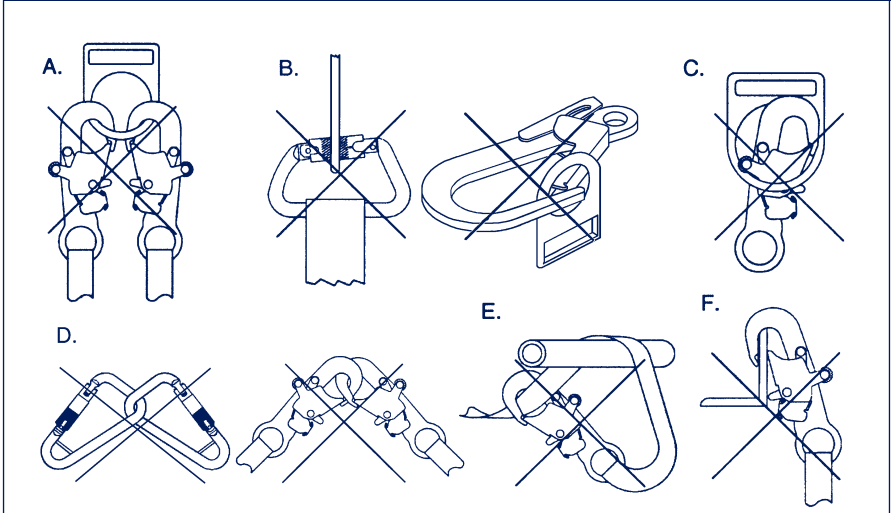
DBI-SALA connectors (snap hooks and carabiners) are designed to be used only as specified in each product's user's instructions. See Figure 7 for inappropriate connections. DBI-SALA snap hooks and carabiners should not be connected:

- A. To a D-ring to which another connector is attached.
- B. In a manner that would result in a load on the gate.

**NOTE:** Large throat opening snap hooks should not be connected to standard size D-rings or similar objects which will result in a load on the gate if the hook or D-ring twists or rotates. Large throat snap hooks are designed for use on fixed structural elements such as rebar or cross members that are not shaped in a way that can capture the gate of the hook.

- C. In a false engagement, where features that protrude from the snap hook or carabiner catch on the anchor and without visual confirmation seems to be fully engaged to the anchor point.
- D. To each other.
- E. Directly to webbing or rope lanyard or tie-back (unless the manufacturer's instructions for both the lanyard and connector specifically allow such a connection).

**Figure 7 - Inappropriate Connections**



- F. To any object which is shaped or dimensioned such that the snap hook or carabiner will not close and lock, or that roll-out could occur.

**2.4 ANCHORAGE STRUCTURE:** The anchorage to which the SRL is attached must be capable of sustaining static loads in the directions applied by the personal fall arrest system of at least 3,600 lbs. with certification of a qualified person, or 5,000 lbs. without certification. See ANSI Z359.1 for certification requirements. When more than one personal fall arrest system is attached to the same structure, the strength requirements stated above must be multiplied by the number of personal fall arrest systems attached to the structure.

- From OSHA 1910.66 and 1926.500: Anchorages used for attachment of a PFAS shall be independent of any anchorage being used to support or suspend platforms, and must support at least 5,000 lbs. (22.2 kN) per user attached, or be designed, installed, and used as part of a complete PFAS which maintains a safety factor of at least two, and is supervised by a qualified person.

**2.5** In applications where an SRL is used in conjunction with a horizontal system (i.e. horizontal I-beams, trolleys), the SRL and horizontal system components must be compatible. Horizontal systems must be designed and installed under the supervision of a qualified engineer.

**2.6** When using an SRL with a support structure (i.e. tripod, davit arm), ensure the support structure is compatible with the connection, operation, stability, and strength of the SRL.

### **3.0 OPERATION AND USE**

**WARNING:** Do not alter or intentionally misuse this equipment. Consult with DBI-SALA when using this equipment in combination with components or subsystems other than those described in this manual. Some subsystem and component combinations may interfere with the operation of this equipment. Use caution when using this equipment around moving machinery, electrical and chemical hazards, and sharp edges.

**WARNING:** Consult your doctor if there is reason to doubt your fitness to safely absorb the shock from a fall arrest. Age and fitness seriously affect a worker's ability to withstand falls. Pregnant women or minors must not use DBI-SALA self retracting lifelines.

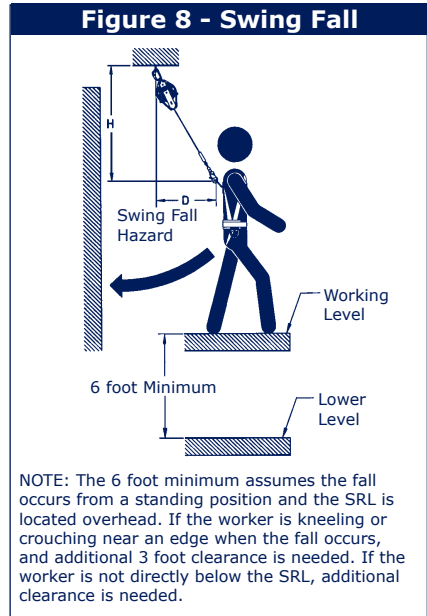
**3.1 BEFORE EACH USE** of this equipment, carefully inspect it according to steps listed in section 5.0.

**3.2 PLANNING:** Plan your fall protection system and how it will be used before starting your work. Consider all factors that will affect your safety before, during, and after a fall. The following list gives some important points to consider when planning your system:

**A. ANCHORAGE:** Select a rigid anchorage point capable of supporting at least 5,000 lbs. See Figure 8 and section 2.4. Select an anchorage location that will avoid free fall and swing fall hazards. To prevent an increased free fall distance do not work above the anchorage.

**B. FREE FALL:** Personal fall arrest systems must be rigged so the potential free fall is never greater than 6 feet. See Figure 8. Avoid working above the anchorage level to avoid an increased free fall distance. Avoid working where your line may cross or tangle with that of other workers or objects. Do not allow the lifeline to pass under arms or between legs. Never clamp, knot, or prevent the lifeline from retracting or being taut. Avoid slack line. Do not lengthen the SRL by connecting a lanyard or other components without consulting DBI-SALA.

**C. SWING FALLS:** Swing falls occur when the anchorage point is not directly above the point where a fall occurs. The force of striking an object in a swing fall may cause serious injury. In a swing fall, the total vertical fall distance will be greater than if the user had fallen directly below the anchorage point, thus increasing the total free fall distance and the area required to safely arrest the user. The SRL will activate regardless of its orientation relative to the user. The recommended work zone represents the typical acceptable work area for most applications. Review your specific application to determine what the appropriate work zone should be. See Chart 1. Minimize swing falls by working as directly below the anchorage point as possible. Never permit a swing fall if injury could occur. If a swing fall situation exists in your application contact DBI-SALA before proceeding. See Figure 8.



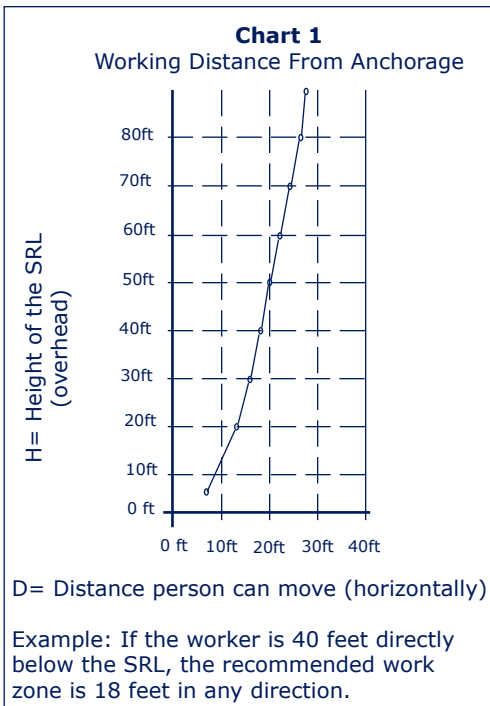
**D. FALL CLEARANCE:**

Ensure adequate clearance exists in your fall path to prevent striking an object. A minimum of 6 feet from the working level to the lower level or nearest obstruction is recommended. See Figure 8.

**E. SHARP EDGES:**

Avoid working where the lifeline will be in contact with or abrade against unprotected sharp edges. Provide protection for the lifeline when possible. An energy absorbing component can sometimes be added in-line to further

protect the worker. Compatibility and total fall distance must be considered if this is done. Contact DBI-SALA before using an in-line energy absorbing component or lanyard with an SRL.



**NOTE ON LEADING EDGE SRL:** Even though the leading edge SRL model provides additional protection from falls occurring over edges, protection against cutting must be provided when working near extremely sharp edges such as sheared, cold rolled, or flames cut steel. Edge protection is not required over edges such as hot rolled steel, steel decking, concrete, or wood.

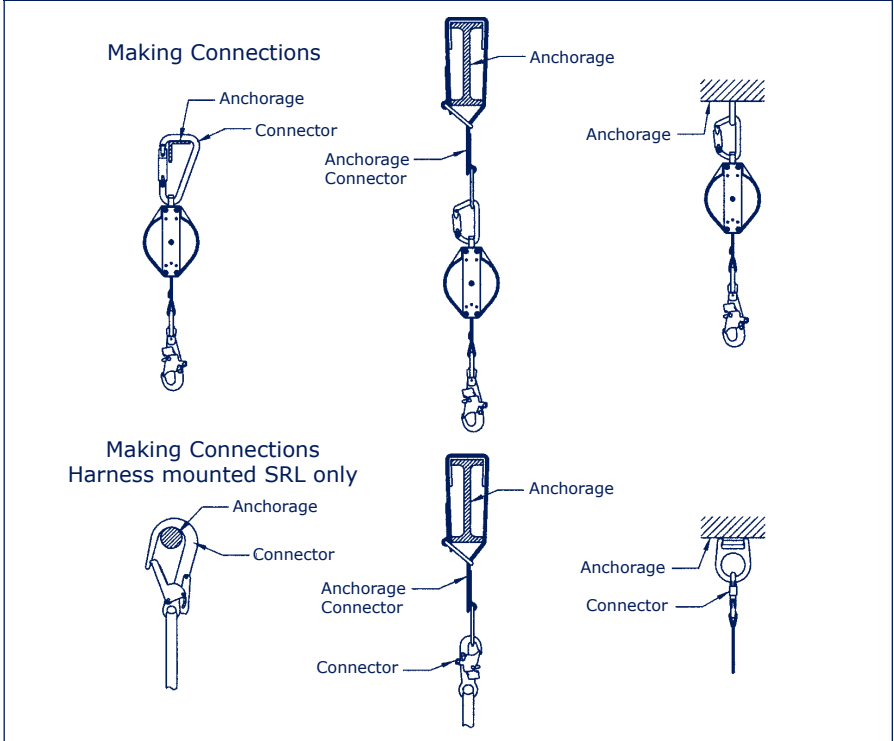
**F. RESCUE:** If a fall occurs, the employer must have a rescue plan and the ability to implement a rescue.

**G. AFTER A FALL:** Equipment which has been subjected to fall arrest forces must be removed from service for inspection. See section 5.0.

**WARNING:** Read and follow manufacturer's instructions for associated equipment (i.e. full body harness) used in your personal fall arrest system.

**IMPORTANT:** For custom versions of this product, see supplemental instructions, if included, for additional instructions.

**Figure 9 - Making Connections**



**3.3 BODY SUPPORT:** When using DBI-SALA SRLs, a full body harness must be worn. For general fall protection use, connect to the back D-ring. For situations such as ladder climbing, attach to the front of the harness. This is acceptable provided the potential free fall is very short, and footing can be easily regained.

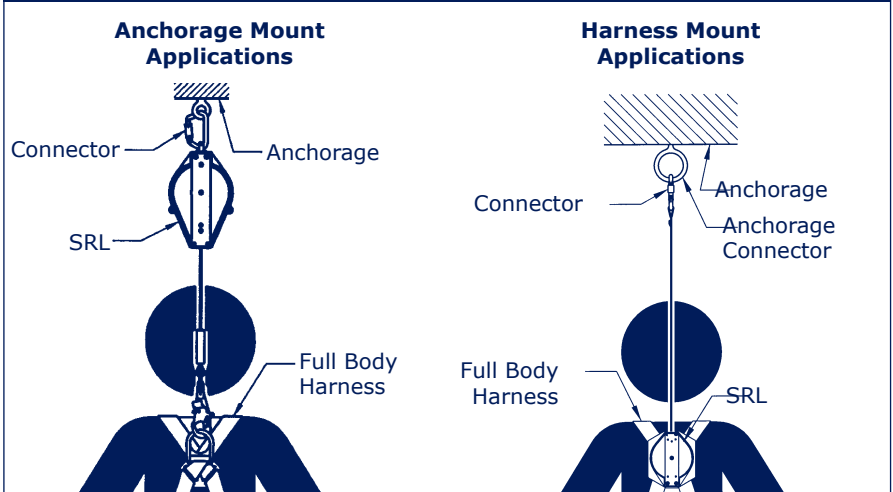
**IMPORTANT:** Do not use a body belt for free fall applications. See OSHA 1926.502 for guidelines.

**3.4 MAKING CONNECTIONS:** When using a hook or carabiner to make a connection, ensure roll-out cannot occur. See section 2.2. Do not use a hook or carabiner that will not completely close over the anchorage or anchorage connector. See Figure 9. Follow the manufacturer's instructions supplied with each system component.

**3.5 OPERATION:** Inspect the SRL as described in section 5.0. Connect the SRL to a suitable anchorage or anchorage connector as described above. Connect the self locking snap hook or self locking/ self closing carabiner on the end of the lifeline to the fall arrest or ladder climbing attachment on the full body harness. Ensure connections are compatible in size, shape, and strength. Ensure the snap hook is securely closed and locked. See Figure 10.



**Figure 10 - Operation**



**3.6 OPERATION OF SRL/FULL BODY HARNESS:** Note: This section only applies to Aluminum Housing, and Ultra-Lok Web Style SRLs used in harness mounted applications. See the full body harness instruction manual for more information. The attached SRL will be located in the center of the user's back when the full body harness has been donned and properly adjusted. Connect the self locking snap hook or carabiner at the end of the lifeline to a suitable anchorage or anchorage connector. See Figure 10.

**3.7 USE:** When attached to the SRL, the worker is free to move about within recommended working areas at normal speeds. The lifeline should extend smoothly and retract without hesitation. If slack line condition is created in normal use the unit should be returned to DBI-SALA for service. Should a fall occur, the SRL will lock and arrest the fall. Upon rescue, remove the SRL from use. Inspect as described in section 5.0. When working with the SRL, allow the lifeline to recoil back into the device under control. A short tag line may be required to extend or retract the lifeline during connection and disconnection. Allowing the lifeline to be fully extended for long periods of time may cause premature weakening of the retraction spring.

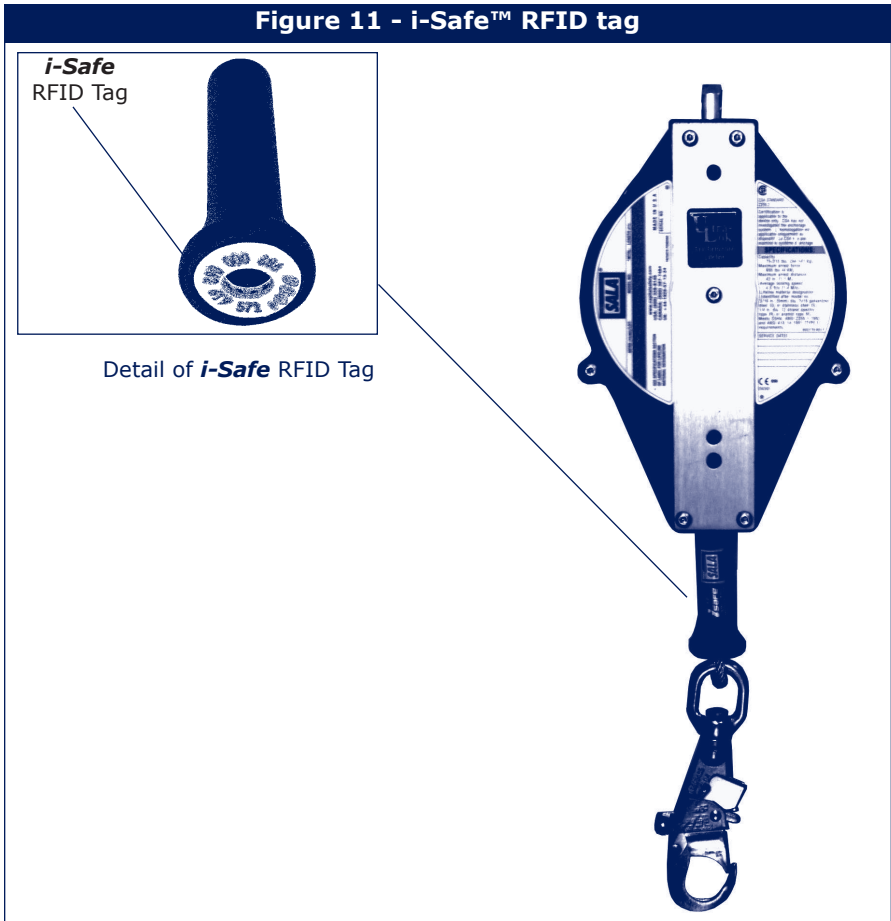
## **4.0 TRAINING**

**4.1** It is the responsibility of the user and the purchaser of this equipment to assure that they are familiar with these instructions, trained in the correct care and use of, and are aware of the operating characteristics, application limits, and the consequences of improper use of this equipment.

**IMPORTANT:** Training must be conducted without exposing the trainee to a fall hazard. Training should be repeated on a periodic basis.

## 5.0 INSPECTION

5.1 The i-Safe™ RFID tag on this SRL can be used in conjunction with the i-Safe handheld reading device and the web based portal to simplify inspection and inventory control and provide records for your fall protection equipment (see Fig. 11).



## 5.2 FREQUENCY

- **Before Each Use:** OSHA 1910.66, OSHA 1926.502 and ANSI Z359.1 requires an inspection of equipment before each use. See sections 5.3, 5.4, and 5.5.
- **Annually:** ANSI Z359.1 requires a formal inspection of the SRL be completed by a competent person other than the user at least annually. More frequent inspections by a competent person may be required based on the nature and severity of workplace conditions affecting the equipment and the modes of use and exposure time of the equipment. See sections 5.3, 5.4, and

5.5 for inspection guidelines. Record the results of each formal inspection in the Inspection and Maintenance log in section 9.0, or use the i-Safe™ inspection web portal to maintain your inspection records. If you are a first-time user, contact a Customer Service representative in the US at 800-328-6146 or in Canada at 800-387-7484 or if you have already registered, go to: [www.capitalsafety.com/isafe.html](http://www.capitalsafety.com/isafe.html). Follow instructions provided with your i-Safe handheld reader or on the web portal to transfer your data to your web log.

NOTE: In Canada, CSA requires SRLs to be serviced within two years of the manufactured date, and annually thereafter.

- **After a Fall Arrest:** Inspect the impact indicator according to section 5.3, and the entire SRL according to sections 5.4 and 5.5.

**WARNING:** *If the self retracting lifeline has been subjected to fall arrest or impact forces, it must be removed from service and inspected according to sections 5.3 and 5.4.*

**IMPORTANT:** *Extreme working conditions (harsh environment, prolonged use, etc.) may require increasing the frequency of inspections.*

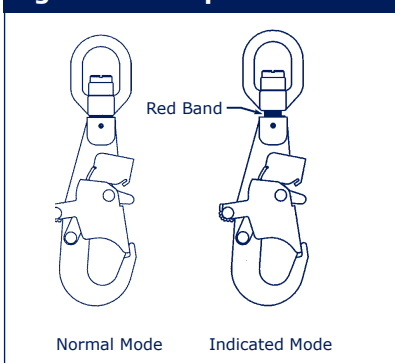
**5.3 IMPACT INDICATOR:** Inspection of impact indicator is dependent on the type of SRL being inspected. The following section details inspection for different SRL types.

**A. CABLE AND ROPE STYLE BLOCKS:** To inspect the impact indicator, look for an exposed red color band as shown in Figure 12. If the hook is found to be in “indicated mode”, an impact load has occurred. SRLs which have been subjected to impact loading must be removed from service for inspection. Do not attempt to reset the impact indicator. Return it to an authorized service center for resetting.

**B. WEB STYLE BLOCKS:** These SRLs incorporate an impact indicator in the web lifeline. The web near the hook end of the lifeline is folded onto itself and stitched with red thread, forming a small loop as shown in Figure 13. The stitched loop will pull out at approximately 450 lbs. If the red stitching is intact, the SRL has not been impacted. If the red stitching has been broken and the loop torn apart,

the SRL has been impact loaded and should be removed from service and returned to an authorized service center

**Figure 12 - Impact Indicator**



for repair. The 3504500 and 3504600 leading edge style Self Retracting Lifelines incorporate an integral energy absorbing component. Inspect the energy absorber to determine if it has been activated. There should be no evidence of elongation. See

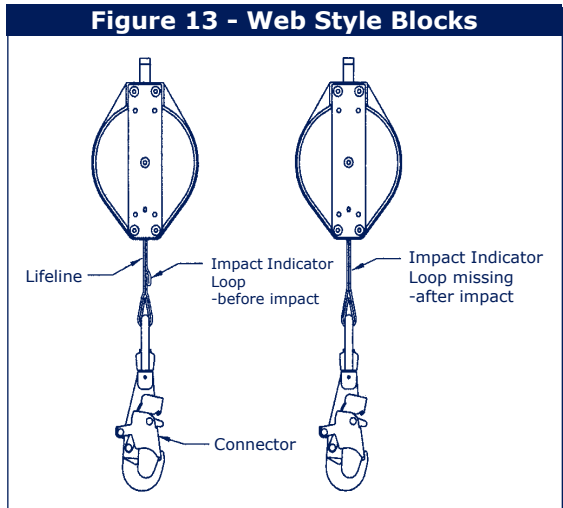
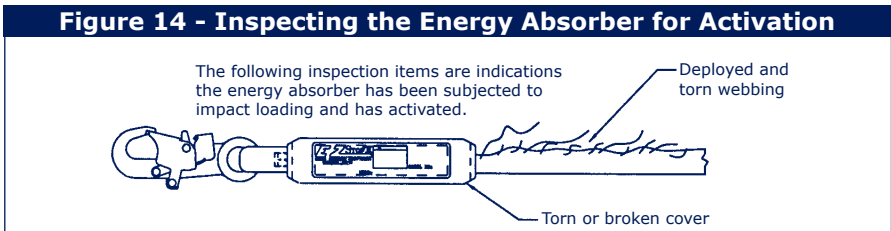


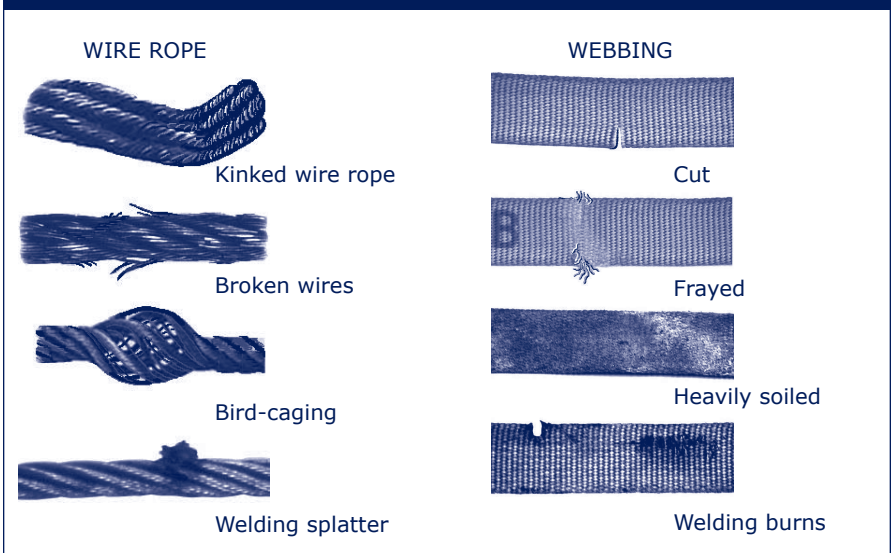
Figure 14. Ensure energy absorber cover is secure and not torn or damaged. If inspection reveals an unsafe condition, remove unit from service immediately and destroy, or contact an authorized service center for repair.



#### 5.4 INSPECTION STEPS:

- Step 1.** Inspect for loose screws and bent or damaged parts.
- Step 2.** Inspect housing for distortion, cracks or other damage. Ensure the swivel eye is not damaged or distorted in any way. Ensure the swivel eye turns freely.
- Step 3.** The lifeline must fully extend and retract without hesitation or creating a slack line condition.
- Step 4.** Ensure the device locks up when lifeline is jerked sharply. Lock-up must be positive, with no slipping.
- Step 5.** The labels must be present and fully legible. See section 8.0
- Step 6.** Look for signs of corrosion on the entire unit.
- Step 7.** Inspect lifeline. On wire rope models, inspect lifeline for cuts, kinks, broken wires, bird-caging, corrosion, welding

**Figure 15 - Lifeline Damage**

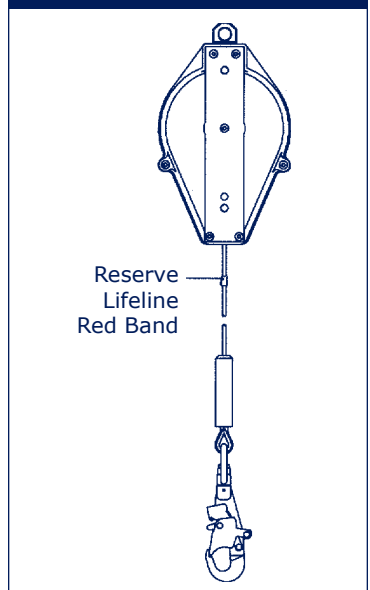


splatter, chemical contact areas, or severely abraded areas (see Figure 15). Slide up cable bumper and inspect ferrules for cracks or damage and inspect wire rope for corrosion and broken wires. On web or synthetic rope models, inspect lifeline for concentrated wear, frayed strands, broken yarn, burns, cuts, and abrasions (see Figure 15). The lifeline must be free of knots throughout its length. Inspect for excessive soiling, paint build-up, and rust staining. Inspect for chemical or heat damage indicated by brown, discolored, or brittle areas. Inspect for ultraviolet damage indicated by discoloration and the presence of splinters and slivers on the lifeline surface.

**Step 8.** Inspect connecting hooks or carabiners for signs of damage, corrosion, and working condition.

**Step 9.** Inspect the reserve lifeline payout. If a fall has been arrested with most of the lifeline out, the reserve lifeline may have been deployed. Pull the lifeline out of the SRL until it stops. If a red band is visible, on web rope type

**Figure 16 - Red Band**



blocks, as shown in Figure 16, or if the reserve lifeline label is visible, on web type blocks, as shown in Figures 3 and 4, the reserve lifeline is spent and the unit must be serviced by an authorized service center before reuse. If the reserve lifeline has not been deployed, continue with inspection.

**Step 10.** Inspect each system component or subsystem per associated manufacturer's instructions.

**Step 11.** Record inspection results in the inspection and maintenance log in section 9.0.

**5.5** If inspection or operation reveals a defective condition, remove the SRL from service and contact an authorized service center for repair.

**NOTE:** Only DBI-SALA, or parties authorized in writing, may make repairs to this equipment.

## **6.0 MAINTENANCE, SERVICING, STORAGE**

**6.1** Periodically clean the exterior of the SRL with water and mild soap solution. Position the SRL so excess water can drain out. Clean labels as required.

**6.2** Clean the lifeline with water and mild soap solution. Rinse and thoroughly air dry. Do not force dry with heat. An excessive buildup of dirt, paint, etc., may prevent the lifeline from fully retracting, causing a potential free fall hazard. Replace the lifeline if there is excessive buildup.

**WARNING:** If the lifeline contacts acids, remove unit from service and wash with water and mild soap solution. Inspect unit before returning to service.

**6.3** Lifeline replacement and additional maintenance and servicing procedures must be completed by an authorized service center. Authorization and a return number must be issued by DBI-SALA. Do not lubricate any parts. Do not disassemble the SRL. See section 5.2 for inspection frequency.

**6.4** Clean and store body support and associated system components according to manufacturer's instructions.

**6.5** Store the SRL in a cool, dry, clean environment, out of direct sunlight. Avoid areas where chemical vapors may exist. Inspect the SRL after extended storage.

## 7.0 SPECIFICATIONS See Figure 17.

In addition to the working range, there is a 2-foot emergency reserve.

Maximum Arresting Force: 900 lbs. When tested in accordance with ANSI Z359.1

Model 3504500 has a larger diameter (7/32 inch) galvanized wire rope and includes an in-line shock absorber.

Maximum Arresting Distance (all models): 42 Inches

Capacity (all models): 75 - 310 lbs.

Meets ANSI Z359.1, CSA Z259.2 and OSHA requirements.

U.S. Patent Number 4,977,647 (hook), Canadian Patent Number 2,027,784

Other patents pending. Foreign patents pending.

**Table 1 - Ultra-Lok Wire and Synthetic Rope SRLs**

Model Number	Working Range	Lifeline Type	Hook Model	Size (L x W x H)	Weight
3504438	20 feet	Spectra Synthetic Rope	9502324	11.56 x 5.98 x 3.34	8 lbs.
3504433	20 feet	Galvanized Wire Rope	9502324	11.56 x 5.98 x 3.34	9 lbs.
3504434	20 feet	Stainless Steel Wire Rope	9502324	11.56 x 5.98 x 3.34	9 lbs.
3504430	30 feet	Galvanized Wire Rope	9502324	11.56 x 5.98 x 3.34	11 lbs.
3504431	30 feet	Stainless Steel Wire Rope	9502324	11.56 x 5.98 x 3.34	11 lbs.
3504453	35 feet	Spectra Synthetic Rope	9502324	11.56 x 5.98 x 3.34	12 lbs.
3504480	50 feet	Vectian Synthetic Rope	9502324	11.56 x 5.98 x 3.34	14 lbs.
3504450	50 feet	Galvanized Wire Rope	9502324	11.56 x 5.98 x 3.34	15 lbs.
3504451	50 feet	Stainless Steel Wire Rope	9502324	11.56 x 5.98 x 3.34	15 lbs.
3504488	50 feet	Spectra Synthetic Rope	9502324	11.56 x 5.98 x 3.34	31 lbs.
3504485	85 feet	Galvanized Wire Rope	9502324	11.56 x 5.98 x 3.34	33 lbs.
3504486	85 feet	Stainless Steel Wire Rope	2102325	11.56 x 5.98 x 3.34	33 lbs.
3504487	85 feet	Stainless Steel Wire Rope	9502324	11.56 x 5.98 x 3.34	33 lbs.
3504500	30 feet	Galvanized Wire Rope	9500100	11.56 x 5.98 x 3.34	16 lbs.
3504600	55 feet	Galvanized Wire Rope	9500100	11.56 x 5.98 x 3.34	33 lbs

See Table 5 for more information.

Models 3103543, 3103544, and 3103547 are attached to full body harness.

In addition to the working range, there is a 21-inch emergency reserve.

Maximum Arresting Force: 900 lbs. When tested in accordance with ANSI Z359.1

Maximum Arresting Distance (all models): 42 Inches

Capacity (all models): 75 - 310 lbs.

Meets ANSI Z359.1, CSA Z259.2, and OSHA requirements.

U.S. Patent Number 4,877,110 and 4,977,647 (hook)

Canadian Patent Number 2,00,516 and 2,027,784 (hook)

Other patents pending. Foreign patents pending.

**Table 2 Ultra-Lok Web SRLs**

<b>Model Number</b>	<b>Working Range</b>	<b>Lifeline Type</b>	<b>Hook Model</b>	<b>Size (L x W x H)</b>	<b>Weight</b>
3103107	11 feet	1 in. Nylon Web	9503175	7.63 x 5.25 x 2.00	4.2 lbs.
3103108	11 feet	1 in. Nylon Web	9500100	7.63 x 5.25 x 2.00	4.2 lbs.
3103113	11 feet	1 in. Nylon Web	2004339	7.63 x 5.25 x 2.00	3.9 lbs.
3103543	11 feet	1 in. Nylon Web	2004339	7.63 x 5.25 x 2.00	6.6 lbs.
3103544	11 feet	1 in. Nylon Web	9503175	7.63 x 5.25 x 2.00	6.9 lbs.
3103547	11 feet	1 in. Nylon Web	9500100	7.63 x 5.25 x 2.00	6.9 lbs.
3103203	20 feet	1 in. Nylon Web	9503175	8.88 x 6.38 x 2.00	5.8 lbs.
3103208	20 feet	1 in. Nylon Web	9500100	8.88 x 6.38 x 2.00	5.8 lbs.
3103213	20 feet	1 in. Nylon Web	2004339	8.88 x 6.38 x 2.00	5.5 lbs.

See Table 5 for more information.



Models 3103334, 3103333, and 3103336 are attached to full body harness.

In addition to the working range, there is a 2-foot emergency reserve.

Maximum Arresting Force: 900 lbs. When tested in accordance with ANSI Z359.1

Maximum Arresting Distance (all models): 42 Inches

Capacity (all models): 75 - 310 lbs.

Meets ANSI Z359.1, CSA Z259.2, and OSHA requirements.

U.S. Patent Number 4,877,110 and 4,977,647 (hook)

Canadian Patent Number 2,000,516 and 2,027,784 (hook)

Other patents pending. Foreign patents pending.

### **Table 3 Aluminum Housing SRLs**

<b>Model Number</b>	<b>Working Range</b>	<b>Lifeline Type</b>	<b>Hook Model</b>	<b>Size (L x W x H)</b>	<b>Weight</b>
3103020	10 ft. 9 in.	1 in. Nylon Web	9503175	7.13 x 5.00 x 2.25	4.3 lbs.
3103031	10 ft. 9 in.	1 in. Nylon Web	9500100	7.13 x 5.00 x 2.25	4.0 lbs.
3103041	10 ft. 9 in.	1 in. Nylon Web	2004339	7.13 x 5.00 x 2.25	4.0 lbs.
3103333	10 ft. 9 in.	1 in. Nylon Web	2004339	7.13 x 5.00 x 2.25	6.7 lbs.
3103336	10 ft. 9 in.	1 in. Nylon Web	9500100	7.13 x 5.00 x 2.25	7.0 lbs.
3103334	10 ft. 9 in.	1 in. Nylon Web	9503175	7.13 x 5.00 x 2.25	7.0 lbs.

See Table 5 for more information.

In addition to the working range, there is a 3-foot emergency reserve.

Maximum Arresting Force: 900 lbs. When tested in accordance with ANSI Z359.1

Maximum Arresting Distance (all models): 42 Inches

Capacity (all models): 75 - 310 lbs.

Meets ANSI Z359.1, CSA Z259.2, and OSHA requirements.

U.S. Patent number 4,877,110 and 4,977,647 (hook)

Canadian Patent Number 2,000,516 and 2,027,784 (hook)

Other patents pending. Foreign patents pending

### **Table 4 - Aluminum Housing Wire Rope SRLs**

<b>Model Number</b>	<b>Working Range</b>	<b>Lifeline Type</b>	<b>Hook Model</b>	<b>Size (L x W x H)</b>	<b>Weight</b>
3506000	11 feet	Galvanized Wire Rope	9502324	7.13 x 5.0 x 2.25	5.4 lbs
3506001	11 feet	Stainless Wire Rope	2102325	7.13 x 5.0 x 2.25	5.4 lbs
3506002	11 feet	Stainless Wire Rope	9502324	7.13 x 5.0 x 2.25	5.4 lbs

See Table 5 for more information.

**Table 5 Hook Information**

<b>Hook Model</b>	<b>Material</b>	<b>Description</b>
9503175	Alloy Steel	Self Locking Snap Hook
9500100	Alloy Steel.	Self Locking Swivel Snap Hook
2004339	Aluminum.	Aluminum Auto-Locking Carabiner with Eye
9502324	Alloy Steel	Self Locking Swivel Snap Hook with Indicator
2102325	Stainless Steel	Self Locking Swivel Snap Hook with Indicator

**7.1 MATERIALS:**

**Ultra-Lok Wire Rope Style Blocks**

**Housing:** Reinforced urethane

**Drum:** Aluminum

**Side Plates:** Aluminum

**Fasteners and Locking Pawls:** Stainless steel

**Main Shaft:** Stainless steel

**Motor Spring:** Stainless steel

**Finish:** Anodized aluminum components

**Lifeline (3504430, 3504433, 3504450, 3504485):** 3/16-inch diameter galvanized wire rope, 4,200 lb. minimum tensile strength.

**Lifeline (3504431, 3504434, 3504451, 3504486, 3504487):** 3/16-inch diameter stainless steel wire rope, 3,600 lb. minimum tensile strength.

**Ultra-Lok Aerospace Wire Rope Style Blocks**

**Housing:** Reinforced urethane

**Drum:** Aluminum

**Side Plates:** Aluminum

**Fasteners and Locking Pawls:** Stainless steel

**Main Shaft:** Stainless steel

**Motor Spring:** Stainless steel

**Finish:** Anodized aluminum components

**Lifeline (3504500):** 3/16-inch diameter stainless steel wire rope, 3,600 lb. minimum tensile strength.

**Ultra-Lok Wire Rope Leading Edge Style Blocks**

**Housing:** 3504500: Reinforced urethane 3504600: Aluminum

**Drum:** Aluminum

**Side Plates:** Aluminum

**Fasteners and Locking Pawls:** Stainless steel

**Main Shaft:** Stainless steel

**Finish:** Anodized aluminum components

**Lifeline:** 7/32-inch diameter galvanized wire rope, 5600 lb. minimum tensile strength

**Energy Absorber:** Nylon/Polyester web

### **Ultra-Lok Rope Style Blocks with Urethane Housing**

All components are identical to those listed above, except lifeline.

**Lifeline:** 1/4-inch diameter Spectra synthetic rope, 5,600 lb. minimum tensile strength or 1/4-inch diameter Vectran Synthetic rope, 6375 lb. minimum strength.

### **85 Ft. Ultra-Lok Wire Rope Style Blocks**

All components are identical to those listed above, except housing, side plates and finish.

**Housing:** Aluminum

**Drum:** Aluminum

**Side Plates:** Incorporated into housing

**Fasteners and Locking Pawls:** Stainless steel

**Main Shaft:** Stainless steel

**Motor Spring:** Stainless steel

**Finish:** Painted

**Lifeline (3504485):** 3/16-inch diameter galvanized wire rope, 4,200 lb. minimum tensile strength.

**Lifeline (3504486, 3504487):** 3/16-inch diameter stainless steel wire rope, 3,600 lb. minimum tensile strength.

### **Ultra-Lok 50 ft. Rope Style Blocks with Aluminum Housing**

All components are identical to those listed above, except lifeline.

**Lifeline:** 1/4-inch diameter Spectra synthetic rope, 5,600 lb. minimum tensile strength.

### **Ultra-Lok Web Style Blocks**

**Housing:** Glass reinforced urethane

**Drum:** Nylon

**Side Plates:** Aluminum

**Fasteners and Locking Pawls:** Stainless steel

**Main Shaft:** Stainless steel

**Motor Spring:** Stainless steel

**Finish:** Custom mold color/anodized

**Lifeline:** 1 inch wide, .090-inch thick nylon webbing, 5,000 lbs. minimum tensile strength.

### **Aluminum Housing Web Style Blocks**

**Housing:** Aluminum

**Drum:** Aluminum

**Side Plates:** Stainless Steel

**Fasteners and Locking Pawls:** Stainless steel

**Main Shaft:** Aluminum

**Motor Spring:** Stainless steel

**Finish:** Anodized

**Lifeline:** 1 inch wide, .090-inch thick nylon webbing, 5,000 lbs. minimum tensile strength.

## **Aluminum Housing Wire Rope Style Blocks**

All components are identical to those listed above, except lifeline.

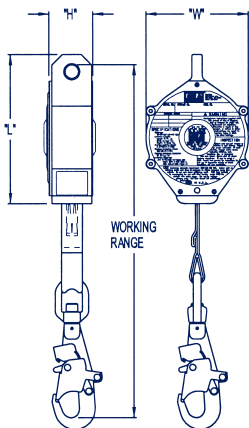
**Lifeline (3506000):** 3/16-inch diameter galvanized wire rope, 4,200 lb. minimum tensile strength.

**Lifeline (3506001):** 3/16-inch diameter stainless steel wire rope, 3,600 lb. minimum tensile strength.

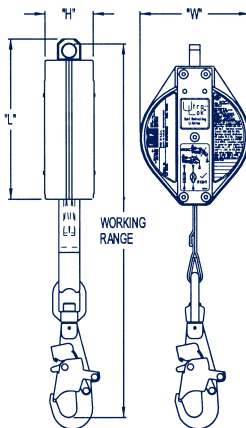
**Lifeline (3506002):** 3/16-inch diameter stainless steel wire rope, 3,600 lb. minimum tensile strength.

**Figure 17 - Specifications**

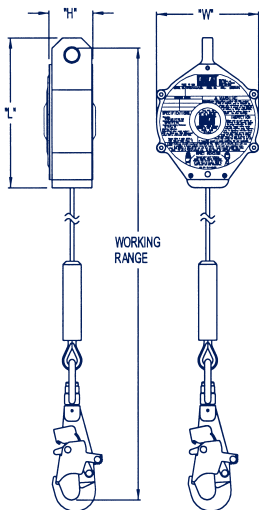
Aluminum Housing Model  
Web Style



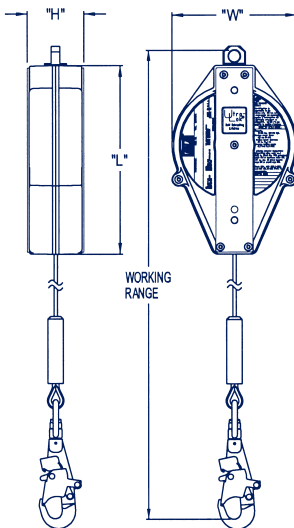
Ultra-Lok Model  
Web Style



Aluminum Housing Model Wire  
Rope Style

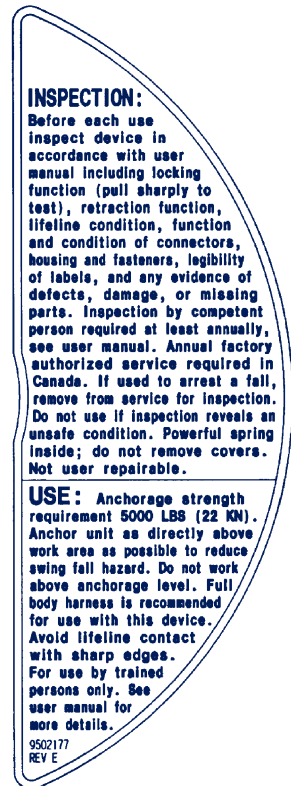
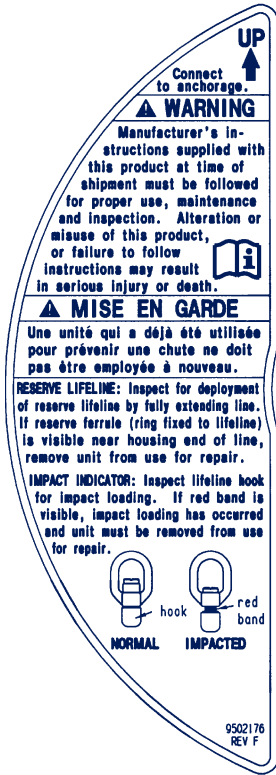


Ultra-Lok Model Wire Rope Style,  
Aerospace Style, Leading Edge Style,  
and Rope Style

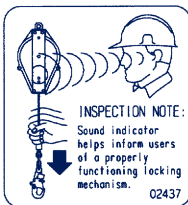


## 8.0 LABELING

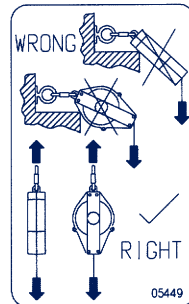
8.1 The following labels must be present and fully legible:



Ultra-Lok Wire Rope Style and  
Aerospace Style  
Warning Label




Ultra-Lok Wire Rope Style  
and Aerospace Style  
Inspection Note Label



Ultra-Lok Wire Rope Style  
and Aerospace Style  
Connections Label

<b>DBI SALA</b>	
MFRD. I/P/N/P/LOT:	MODEL NO:
	*MTRL: LENGTH/FT:
USA 3965 PEPIN AVE. RED WING, MN 55066 (800) 328-6146	CANADA 260 EXPORT BLVD. MISSISSAUGA, ONTARIO L5S 1Y9 (800) 387-7484
*SEE SPECIFICATIONS SECTION OF LABEL FOR LIFELINE MATERIAL DESIGNATION.	
MADE IN U.S.A.	
SERIAL NO.	
PATENTS PENDING	




CSA STANDARD Z259.2
Certification is applicable to the device only. CSA has not investigated the anchorage system. L'homologation est applicable uniquement au dispositif. La CSA n'a pas examiné le système d'ancrage.
<b>SPECIFICATIONS:</b>
Capacity: 75-310 lbs. (34-141 Kg).
Maximum arrest force: 900 lbs (4 KN).
Maximum arrest distance: 42 in. (1.1 M).
Average locking speed: 4.5 ft/s (1.4 M/s).
Lifeline material designation: (identified after model no.) 3/16 in. (5mm) dia. 7x19 galvanized steel (G) or stainless steel (S). 1/4 in. dia. 12 strand spectra rope (R) or aramid rope (K).
Meets OSHA, ANSI Z359.1-1992, and ANSI A10.14-1991 (TYPE I) requirements.
SERVICE DATES







Ultra-Lok Wire Rope Style and  
Aerospace Style ID Label



Aluminum Housing Web Style ID and Cover Labels

 <p>DBI/SALA 3965 PEPIN AVE. RED WING, MN 55066 (800) 328-6146</p>		SERIAL NO.    MFRD(YR/MO)/LOT:    MODEL NO:    LENGTH(FT):	
		SERVICE DATES	
<b>SPECIFICATIONS</b> Capacity: 75-310 LBS (34-141 Kg) Average Locking Speed: 4.5 FT/S (1.4 M/S) Maximum Arresting Force: 900 LBS (4.0 KN) Maximum Arresting Distance: 42 IN (1.1 M) Lifeline Material: .1x1 IN (2.5x25 mm) Nylon Web  Meets OSHA & ANSI Z359.1. ANSI A10.14-1991 (Type 1)		<b>WARNING</b> Manufacturers instructions supplied with this product at time of shipment, must be followed for proper use, maintenance and inspection. Alteration or misuse of this product, or failure to follow instructions, may result in serious injury or death. See other markings.	
<b>USE</b> Anchorage strength requirement 5000 LBS (22 KN). Anchor unit as directly above work area as possible to reduce possible swing fall hazard. Do not work above anchorage level. Full body harness is recommended for use with this device. Avoid lifeline contact with sharp edges. For use by trained persons only. See User Manual for additional information. MADE IN U.S.A.		<b>INSPECTION</b> Before each use pull sharply on lifeline to test locking. Inspect for proper retraction. At least monthly, inspect entire device including lifeline, hook, fasteners, etc. in accordance with User Manual. Factory authorized service required every two years. (Annually in Canada) see User Manual. Do not use if inspection reveals an unsafe condition. Not user repairable.	
U.S. PAT. NO. 4,877,110, CANADIAN PAT. NO. 2,000,516  POWERFUL MOTOR SPRINGS INSIDE DO NOT REMOVE COVER. MADE IN U.S.A.			

USA 3965 PEPIN AVE. RED WING, MN 55066 (800) 328-6146		 <p>CANADA 260 EXPORT BLVD. MISSISSAUGA, ONTARIO, CANADA, L5S 1Y9 (800) 387-7484</p>		SERIAL NO.    MFRD(YR/MO)/LOT:    MODEL NO:    LENGTH(FT):	
				SERVICE DATES	
<b>SPECIFICATIONS</b> Capacity: 75-310 LBS (34-141 Kg) Max Arrest Distance: 42 IN (1.1 M) Max Arresting Force: 900 LBS (4 KN) Lifeline Material: .1 x 1 IN Nylon web (2.5 x 25mm)		<b>WARNING/MISE EN GARDE</b> Manufacturers instructions supplied with this product must be followed for proper use. Failure to follow instructions may result in serious injury or death. Any unit which has seen fall arresting service should not be used after such service. Une unité qui a déjà été utilisée pour prévenir une chute doit pas être employée à nouveau.		<b>INSPECTION</b> Before each use pull sharply on lifeline to test locking. Inspect for proper retraction. Inspect entire device at least monthly in accordance with User Manual. Factory authorized service required every two years. (Annually in Canada) see User Manual. Do not use if inspection reveals an unsafe condition. Not user repairable.	
<b>USE</b> Anchorage strength requirement 5400 LBS (24 KN). Anchor unit directly above work area to reduce swing fall hazard. Do not work above anchorage level. Full body harness is recommended. Avoid lifeline contact with sharp edges.		U.S. PAT. NO. 4,877,110, CANADIAN PAT. NO. 2,000,516  POWERFUL MOTOR SPRINGS INSIDE DO NOT REMOVE COVER. MADE IN U.S.A.		CERTIFICATION IS APPLICABLE TO THE DEVICE ONLY. CSA HAS NOT INVESTIGATED THE ANCHORAGE SYSTEM. L' HOMOLOGATION EST APPLICABLE UNIQUEMENT AU DISPOSITIF. LA CSA N'A PAS EXAMINÉ LE SYSTÈME D' ANCRAGE <b>CRA STANDARD 2269.2</b>	
UP  CONNECT INSPECTION					



Ultra-Lok Web Style  
Warning Labels

**UP**  
↑  
Connect to anchorage.

**WARNING**  
Manufacturer's instructions supplied with this product at time of shipment, must be followed for proper use, maintenance, and inspection. Alteration or misuse of this product, or failure to follow instructions, may result in serious injury or death.

**MISE EN GARDE**  
Une unité qui a déjà été utilisée pour prévenir une chute ne doit pas être employée à nouveau.

**INSPECTION:**  
Before each use pull sharply on the lifeline to test locking. Inspect for proper retraction. At least monthly, inspect entire

device including lifeline, hook, fasteners, etc. in accordance with User Manual. Factory authorized service required every two years, (annually in Canada) see User Manual. If used to arrest a fall, remove from service for inspection. Do not use if inspection reveals an unsafe condition. Powerful spring inside, do not remove covers. Not user repairable.

**USE:** Anchorage strength requirement 6000 LBS (22 KN). Anchor unit as directly above work area as possible to reduce swing fall hazard. Do not work above anchorage level. Full body harness is recommended for use with this device. Avoid lifeline contact with sharp edges. For use by trained persons only. See User Manual for more details.

Ultra-Lok Web Style  
ID Labels

**OB**  
**SALA**

Canada: 260 Export Blvd.,  
St. Catharines, Ontario, L2R 7W9  
Canada L2R 7W9  
(800) 367-7444

MADE IN U.S.A.  
U.S. PAT. NO. 4,877,110 FOREIGN PATENTS PENDING

MODEL NO. \_\_\_\_\_  
LENGTH (FT): \_\_\_\_\_

SERIAL NO. \_\_\_\_\_  
MFRD./YR./MO./LOT: \_\_\_\_\_

URL: [www.ob.com](http://www.ob.com)  
Tel: 800-367-7444  
(800) 367-7444

**CSA**®

**CSA Standard Z259.2**

CERTIFICATION IS APPLICABLE TO THE DEVICE ONLY. CSA HAS NOT INVESTIGATED THE ANCHORAGE SYSTEM. L'HOLOGRAPHIE EST APPLICABLE ENVOUSSEMENT AU DISPOSITIF. LA CSA N'A PAS EXAMINÉ LE SYSTÈME D'ANCORAGE.

**SPECIFICATIONS:**  
Capacity: 75-310 LBS (34-141 Kg). Maximum arrest force: 900 LBS (4 KN). Maximum arrest distance: 42 inches (1.1 M). Average locking speed: 4.5 FT/SEC (1.4 M/S). Lifeline length is given as last digits in model no., FT. Lifeline mat'l: .1x1 in (2.5x25 mm) nylon webbing. Meets OSHA & ANSI Z359.1-1992. ANSI A10.14-1991 (Type I)

SERVICE DATED

\_\_\_\_\_

\_\_\_\_\_

\_\_\_\_\_

\_\_\_\_\_

# 9.0 INSPECTION AND MAINTENANCE LOG

**SERIAL NUMBER:** \_\_\_\_\_

**MODEL NUMBER:** \_\_\_\_\_

**DATE PURCHASED:** \_\_\_\_\_

INSPECTION DATE	INSPECTION ITEMS NOTED	CORRECTIVE ACTION	MAINTENANCE PERFORMED
Approved By: _____			
Approved By: _____			
Approved By: _____			
Approved By: _____			
Approved By: _____			
Approved By: _____			
Approved By: _____			
Approved By: _____			
Approved By: _____			
Approved By: _____			
Approved By: _____			
Approved By: _____			
Approved By: _____			



## 9.0 INSPECTION AND MAINTENANCE LOG

**SERIAL NUMBER:** \_\_\_\_\_

**MODEL NUMBER:** \_\_\_\_\_

**DATE PURCHASED:** \_\_\_\_\_

INSPECTION DATE	INSPECTION ITEMS NOTED	CORRECTIVE ACTION	MAINTENANCE PERFORMED
Approved By: _____			
Approved By: _____			
Approved By: _____			
Approved By: _____			
Approved By: _____			
Approved By: _____			
Approved By: _____			
Approved By: _____			
Approved By: _____			
Approved By: _____			
Approved By: _____			
Approved By: _____			
Approved By: _____			
Approved By: _____			



This instruction applies to the following models:

1100299	3103104	3103201	3103235	3103520	3504452C
1100550	3103105	3103202	3103236	3103521	3504453
1101069	3103106	3103203	3103237	3103522	3504453C
1199997	3103107	3103204	3103238	3103523	3504454
3103020	3103107C	3103205	3103300	3103524	3504455
3103020C	3103108	3103206	3103301	3103543	3504457
3103021	3103108C	3103207	3103330	3103544	3504458
3103022	3103109	3103207C	3103331	3103547	3504459C
3103023	3103110	3103208	3103332	3103549	3504460C
3103024	3103111	3103208C	3103333	3103862	3504480
3103025	3103113	3103209	3103334	3504400	3504480C
3103026	3103114	3103209C	3103335	3504430	3504485
3103027	3103116	3103210	3103336	3504430C	3504485C
3103028	3103117	3103211	3103337	3504431	3504486
3103029	3103118	3103212	3103350	3504431C	3504486C
3103030	3103119	3103212C	3103351	3504432	3504487
3103031	3103120	3103213	3103360	3504432C	3504488
3103031C	3103120C	3103214	3103361	3504433	3504500
3103032	3103121	3103215	3103375	3504433C	3504500C
3103032C	3103121C	3103217	3103377	3504434	3504501
3103033	3103122	3103218	3103385	3504434C	3504502
3103033C	3103123	3103219	3103386	3504436	3504600
3103034	3103124	3103220	3103387	3504437	3506000
3103036	3103125	3103221	3103388	3504437C	3506000C
3103037	3103126	3103222	3103389	3504438	3506001
3103040	3103127	3103223	3103390	3504439	3506001C
3103041	3103128	3103225	3103395	3504440	3506002
3103042	3103129	3103226	3103420	3504441C	3506002C
3103043	3103130	3103227	3103450	3504442C	3507001
3103045	3103131	3103228	3103451	3504443	3507001C
3103047	3103133	3103229	3103452	3504450	3507002
3103048	3103134	3103230	3103453	3504450C	3507002C
3103049	3103135	3103231	3103465	3504451	
3103050	3103136	3103233	3103471	3504451C	
3103103	3103136C	3103234	3103515	3504452	

Additional model numbers may appear on the next printing.



## WARRANTY

Equipment offered by DBI-SALA is warranted against factory defects in workmanship and materials for a period of two years from date of installation or use by the owner, provided that this period shall not exceed two years from date of shipment. Upon notice in writing, DBI-SALA will promptly repair or replace all defective items. DBI-SALA reserves the right to elect to have any defective item returned to its plant for inspection before making a repair or replacement. This warranty does not cover equipment damages resulting from abuse, damage in transit, or other damage beyond the control of DBI-SALA. This warranty applies only to the original purchaser and is the only one applicable to our products, and is in lieu of all other warranties, expressed or implied.



A Capital Safety Brand

### USA

3833 SALA Way  
Red Wing, MN 55066-5005  
Toll Free: 800-328-6146  
Phone: (651) 388-8282  
Fax: (651) 388-5065  
E-mail: [info@capitalsafety.com](mailto:info@capitalsafety.com)

### Canada

260 Export Boulevard  
Mississauga, Ontario L5S 1Y9  
Toll Free: 800-387-7484  
Phone: (905) 795-9333  
Fax: (905) 795-8777  
E-mail: [info@dbisala.com](mailto:info@dbisala.com)

### United Kingdom

Unit 7 Christleton Court  
Manor Park  
Runcorn, Cheshire WA71ST  
Tel. 01928 57 13 24  
Fax 01928 57 13 25  
E-mail: [info@salagroupco.uk](mailto:info@salagroupco.uk)

### Germany

Flustr. 63, D-47533  
Kleve, Germany  
Tel: +(49) 2821 7533 0  
Fax: +(49) 2821 7533 20  
E-mail: [info@csgne.de](mailto:info@csgne.de)

### Sweden

P.O. Box 134, Fridhemsgatan 4  
S-733 22 Sala, Sweden  
Tel: +(46) 224 37585  
Fax: +(46) 224 15253  
E-mail: [info@csgne.se](mailto:info@csgne.se)

This manual is available for download at [www.capitalsafety.com](http://www.capitalsafety.com)



Certificate No. FM 39709