



**JOHN L.
SCHULTZ** LTD.
LTÉE.

CATALOGUE 2015

Valves ~ Faucets ~ Specialties ~ Fittings & Nipples



aqua-dynamic™

CATALOGUE SECTIONS

Click to go to section



Pages 1-1 to 1-16



Pages 2-1 to 2-10



Pages 3-1 to 3-30

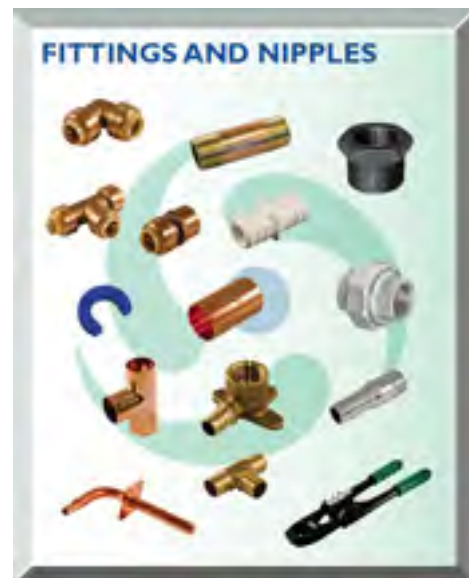

Pages 4-1 to 4-28

 *Part Number Numerical Listing*

 *Terms and Conditions*

VALVES



VALVES	PAGE
BACKFLOW PREVENTERS	1-13
BALL VALVES - BRASS	1-1 to 1-3
FULL PORT, STANDARD PORT, COMPRESSION & PEX	
BALL VALVES - GAS	1-4
ONE PIECE, TWO PIECE & FULL PORT	
BALL VALVES - PVC & TRUE UNION	1-5
BARREL & DRUM FAUCETS	1-14
BOILER DRAINS	1-7 to 1-9
ANGLE, STRAIGHT, COMPRESSION, CPVC CONNECTION & LOCKNUT	
CHECK VALVES	1-13, 1-14
SWING CHECK BRASS, IN LINE BRONZE & IN LINE PVC	
FLOAT VALVES - BRONZE	1-14
FOOT VALVES - BRONZE	1-13
GARDEN HOSE VALVES	1-10
GATE VALVES	1-6
HOSE BIBBS	1-9
OIL TANK VALVE - BRASS	1-14
RADIATOR VALVES - BRASS	1-14
SILLCOCKS	1-10
STOP VALVES	1-6, 1-7
WITH DRAIN, COMPRESSION & CPVC CONNECTION	
SUPPLY STOPS	1-15, 1-16
ANGLE, STRAIGHT & QUARTER TURN	
TOILET TANK ANTI-SWEAT VALVES	1-14
VACUUM BREAKERS	1-10
WALL HYDRANTS - NON-FREEZE	1-11, 1-12
HEAVY DUTY, ANTI-SIPHON & QUARTER TURN	
WASHING MACHINE VALVES - BRONZE	1-9

Valves

BALL VALVES - FULL PORT - LEAD FREE

- Forged brass body
- PTFE seats
- CSA, cUPC certified
- Meets NSF/ANSI 372 lead free standard
- -29° to 149°C temperature range, 600 PSI

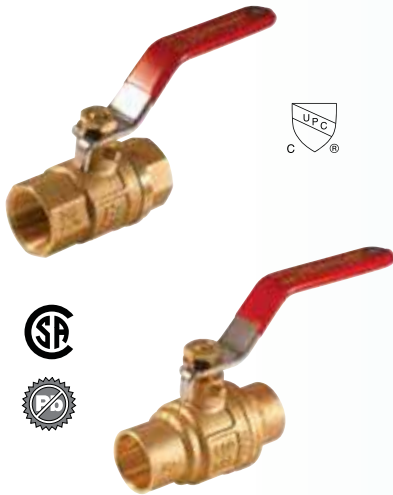

PART NO.	TYPE	SIZE	INNER	MASTER
1197-000	Threaded	1/8"	20	200
1197-001	Threaded	1/4"	20	200
1197-002	Threaded	3/8"	10	150
1197-003	Threaded	1/2"	10	100
1197-004	Threaded	3/4"	10	80
1197-005	Threaded	1"	5	50
1197-006	Threaded	1 1/4"	5	30
1197-007	Threaded	1 1/2"	4	20
1197-008	Threaded	2"	4	16
1197-503	Solder	1/2"	10	100
1197-504	Solder	3/4"	10	80
1197-505	Solder	1"	6	48

BALL VALVES - FULL PORT - PUSH-FIT - LEAD FREE

NEW

- Forged brass body
- Easy installation - no solder, flux or glues required
- Joins copper, CPVC and PEX tubing in any combination
- cUPC certified
- Meets NSF/ANSI 372 lead free standard
- -18° to 82°C temperature range, 200 PSI

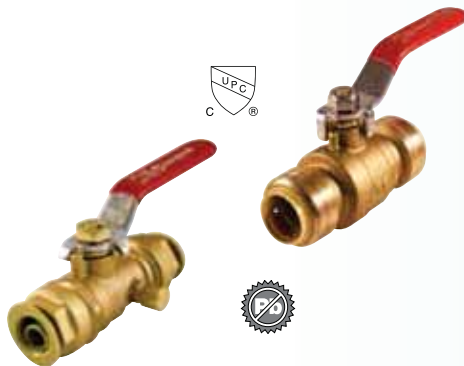

PART NO.	TYPE	SIZE	INNER	MASTER
1107-923	Push-Fit	1/2"	5	50
1107-924	Push-Fit	3/4"	5	50
1107-925	Push-Fit	1"	5	50
1107-933	Push-Fit with drain	1/2"	6	36
1107-934	Push-Fit with drain	3/4"	6	36

BALL VALVES - FULL PORT - COMPRESSION - LEAD FREE

- Forged brass body
- PTFE seats
- Compression ends allow solderless connection to copper tubing
- CSA, cUPC certified
- Meets NSF/ANSI 372 lead free standard
- -29° to 149°C temperature range, 600 PSI



PART NO.	TYPE	SIZE	INNER	MASTER
1197-023	Compression	1/2"	6	36
1197-024	Compression	3/4"	6	36
1197-025	Compression	1"	6	24
1197-033	Compression with drain	1/2"	6	36
1197-034	Compression with drain	3/4"	6	36
1197-035	Compression with drain	1"	6	24

Valves

BALL VALVES - FULL PORT - WITH DRAIN - LEAD FREE

- Forged brass body
- PTFE seats
- This valve can be used to regulate flow or as a shutoff
- Drain cap allows draining of the non-pressure side of the valve when closed
- CSA, cUPC certified
- Meets NSF/ANSI 372 lead free standard
- -18° to 82°C temperature range, 600 PSI

PART NO.	TYPE	SIZE	INNER	MASTER
1197-553	Solder	1/2"	10	100
1197-554	Solder	3/4"	10	60
1197-555	Solder	1"	6	36
1197-753	Threaded	1/2"	10	100
1197-754	Threaded	3/4"	10	60
1197-755	Threaded	1"	6	36

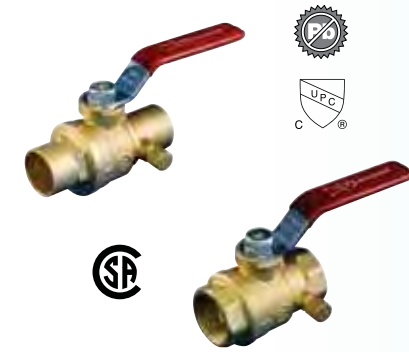

BALL VALVES - STANDARD PORT - LEAD FREE

- Forged brass body
- PTFE seats
- cUPC certified
- Meets NSF/ANSI 372 lead free standard
- -18° to 82°C temperature range, 600 PSI

PART NO.	TYPE	SIZE	INNER	MASTER
1197-903	Threaded	1/2"	10	100
1197-904	Threaded	3/4"	10	100
1197-905	Threaded	1"	10	50
1197-906	Threaded	1 1/4"	10	50
1197-907	Threaded	1 1/2"	4	20
1197-803	Solder	1/2"	10	100
1197-804	Solder	3/4"	10	100

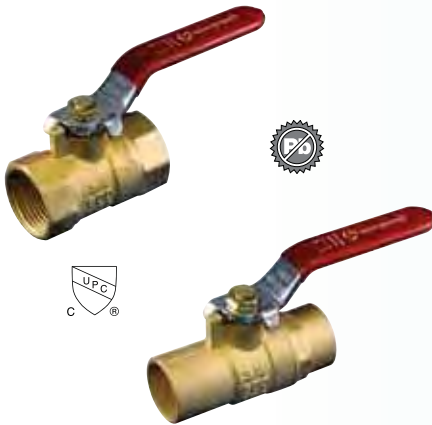

BALL VALVES - FULL PORT - PEX - LEAD FREE

- Forged brass body
- For use in F1807 PEX or F1960 PEX systems
- This valve can be used to regulate flow or as a shutoff.
- cUPC certified
- Meets NSF/ANSI 372 lead free standard
- 80°C maximum temperature, 200 PSI

PART NO.	TYPE	SIZE	INNER	MASTER
1197-343	PEX, Lever Handle	1/2"	10	120
1197-344	PEX, Lever Handle	3/4"	10	80
1197-345	PEX, Lever Handle	1"	6	48
NEW 1197-373	F1960 PEX, Lever Handle	1/2"	10	120
NEW 1197-374	F1960 PEX, Lever Handle	3/4"	10	80
NEW 1197-393	PEX, Butterfly Handle	1/2"	10	120
NEW 1197-394	PEX, Butterfly Handle	3/4"	10	80
NEW 1197-395	PEX, Butterfly Handle	1"	6	48



Valves

BALL VALVES - FULL PORT - WITH DRAIN - PEX - LEAD FREE



- Forged brass body
- For use in F1807 PEX systems
- This valve can be used to regulate flow or as a shutoff.
- cUPC certified
- Meets NSF/ANSI 372 lead free standard
- 80°C maximum temperature, 200 PSI

PART NO.	TYPE	SIZE	INNER	MASTER
1991-623	PEX, Lever Handle	1/2"	10	120
1991-624	PEX, Lever Handle	3/4"	10	100
NEW 1197-743	PEX, Butterfly Handle	1/2"	10	120
NEW 1197-744	PEX, Butterfly Handle	3/4"	10	80
NEW 1197-745	PEX, Butterfly Handle	1"	6	48

BALL VALVES - FULL PORT - SOLDER x PEX LEAD FREE



NEW

- Forged brass body
- PTFE seats
- This valve can be used to regulate flow or as a shutoff
- cUPC certified
- Meets NSF/ANSI 372 lead free standard
- 80°C maximum temperature, 200 PSI

PART NO.	TYPE	SIZE	INNER	MASTER
1197-543	Solder x PEX	1/2"	10	100
1197-544	Solder x PEX	3/4"	10	100

BALL VALVES - FULL PORT - WITH DRAIN SOLDER x PEX - LEAD FREE



NEW

- Forged brass body
- PTFE seats
- This valve can be used to regulate flow or as a shutoff
- cUPC certified
- Meets NSF/ANSI 372 lead free standard
- 80°C maximum temperature, 200 PSI

PART NO.	TYPE	SIZE	INNER	MASTER
1197-443	Solder x PEX	1/2"	10	100
1197-444	Solder x PEX	3/4"	10	80

BALL VALVES - FULL PORT COMPRESSION x PEX - LEAD FREE



NEW

- Forged brass body
- PTFE seats
- This valve can be used to regulate flow or as a shutoff
- cUPC certified
- Meets NSF/ANSI 372 lead free standard
- 80°C maximum temperature, 200 PSI

PART NO.	TYPE	SIZE	INNER	MASTER
1197-643	Compression x PEX	1/2"	10	100
1197-644	Compression x PEX	3/4"	6	48

Valves

GAS BALL VALVES - FULL PORT

- Two-piece forged brass body, blowout proof stem
- Threaded valves Gas approvals: CSA/CUS - ANSI Z21.15/CGA 9.1, ASME B16.44, CGA CR 91-002, CAN/CGA 3.16, ASME B16.33 & ASME B16.38. UL, FM certified
- Solder valves are FM certified
- -20° to 90°C temperature range, 600 PSI



FM Approved

UL LISTED



FM Approved



UL LISTED

FM Approved



PART NO.	TYPE	SIZE	INNER	MASTER
1107-821	Threaded	1/4"	15	120
1107-822	Threaded	3/8"	15	120
1107-823	Threaded	1/2"	15	120
1107-824	Threaded	3/4"	10	60
1107-825	Threaded	1"	8	48
1107-826	Threaded	1 1/4"	4	24
1107-827	Threaded	1 1/2"	2	24
1107-828	Threaded	2"	2	12
1107-829	Threaded	2 1/2"	2	6
1107-830	Threaded	3"	2	4
1107-831	Threaded	4"	1	2
1107-843	Solder	1/2"	15	120
1107-844	Solder	3/4"	10	60
1107-944	Solder - "T" handle	3/4"	10	60
1107-845	Solder	1"	8	48
1107-945	Solder - "T" handle	1"	8	48
1107-846	Solder	1 1/4"	4	24
1107-847	Solder	1 1/2"	2	24
1107-848	Solder	2"	2	12
1107-849	Solder	2 1/2"	2	6
1107-850	Solder	3"	2	4
1107-851	Solder	4"	1	2

GAS BALL VALVES - ONE-PIECE BODY

- One-piece forged brass body
- UL and FM certified
- ASME B16.44 for use in above ground piping systems up to 5 PSI
- ANSI / ASME B16.33 for use with natural, manufactured, mixed and liquified petroleum gases or propane gas and LP gas-air mixtures
- 1/2 PSIG and 5 G
- CGA CR91-002 Certified for use on piping
- ANSI Z21.15/CSA 9.1 certified for appliances, appliance connectors and hose end valves
- Max. Temp. Rating: 38°C
- Max. Pressure Rating: 100 PSI

PART NO.	TYPE	SIZE	INNER	MASTER
1110-523	Lever Handle	1/2"	10	100
1110-524	Lever Handle	3/4"	10	100

GAS BALL VALVES - TWO-PIECE BODY

- Forged brass body
- Double O-ring packing
- PTFE seats
- CSA/CUS gas approval: ANSI Z21.15 & CGA 9.1, CGA 91-002 & ASME B16.44
- -20° to 80°C temperature range, 600 PSI

PART NO.	TYPE	SIZE	INNER	MASTER
1110-923	Female x Female	1/2"	10	100
1110-924	Female x Female	3/4"	10	100
1114-522	Flare x Female	3/8" x 1/2"	10	100
1114-523	Flare x Female	1/2" x 1/2"	10	100
1114-544	Flare x Female	1/2" x 3/4"	10	100
1116-503	Flare x Flare	1/2"	10	100
1116-504	Flare x Flare	5/8"	10	100



Valves

PVC BALL VALVES - PUSH-FIT

- Sure Seal window allows view of pipe connection
- Use without solvents
- Quarter-Turn Operation
- Fits both Schedule 40 and Schedule 80 pipe
- NSF certified



PART NO.	TYPE	SIZE	INNER	MASTER
1107-233	Push-Fit	1/2"	10	40
1107-244	Push-Fit	3/4"	8	32

PVC BALL VALVES - WHITE

- Manufactured in an ISO 9002 facility
- White color, EPDM seats
- EPDM O-Rings
- Fits both Schedule 40 & Schedule 80 PVC pipe
- NSF certified
- Rated at 150 PSI at 23°C



PART NO.	TYPE	SIZE	INNER	MASTER
1107-133	Threaded	1/2"	10	100
1107-134	Threaded	3/4"	5	60
1107-135	Threaded	1"	5	40
1107-136	Threaded	1 1/4"	5	30
1107-137	Threaded	1 1/2"	4	24
1107-138	Threaded	2"	2	16

1107-633	Solvent	1/2"	10	100
1107-634	Solvent	3/4"	5	60
1107-635	Solvent	1"	5	40
1107-636	Solvent	1 1/4"	5	30
1107-637	Solvent	1 1/2"	4	24
1107-638	Solvent	2"	2	16
1107-639	Solvent	2 1/2"	1	12
1107-640	Solvent	3"	1	6

PVC BALL VALVES - GREY

- Manufactured in an ISO 9002 facility
- Grey colour, Teflon® seats
- EPDM O-Rings
- Fits both Schedule 40 & Schedule 80 PVC pipe
- NSF certified
- Rated at 150 PSI at 23°C



PART NO.	TYPE	SIZE	INNER	MASTER
1107-103	Threaded	1/2"	10	100
1107-104	Threaded	3/4"	5	60
1107-105	Threaded	1"	5	40
1107-106	Threaded	1 1/4"	5	30
1107-107	Threaded	1 1/2"	4	24
1107-108	Threaded	2"	2	16

1107-603	Solvent	1/2"	10	100
1107-604	Solvent	3/4"	5	60
1107-605	Solvent	1"	5	40
1107-606	Solvent	1 1/4"	5	30
1107-607	Solvent	1 1/2"	4	24
1107-608	Solvent	2"	2	16

PVC BALL VALVES - TRUE UNION

- Shipped with both threaded & solvent ends
- Grey colour, Teflon® seats
- EPDM stem O-rings
- Fits Schedule 40 & Schedule 80 PVC pipe
- NSF certified
- Rated at 150 PSI at 23°C



PART NO.	TYPE	SIZE	INNER	MASTER
1107-203	Threaded or Solvent	1/2"	1	72
1107-204	Threaded or Solvent	3/4"	1	60
1107-205	Threaded or Solvent	1"	1	45
1107-206	Threaded or Solvent	1 1/4"	1	24
1107-207	Threaded or Solvent	1 1/2"	1	16
1107-208	Threaded or Solvent	2"	1	12



GATE VALVES - LEAD FREE

- Brass construction
- Full Port, non-rising stem
- Teflon packing, cast iron handle
- Use in a fully open or fully closed position
- Meets NSF/ANSI 372 lead free standard
- -18° to 82°C temperature range, 200 PSI

PART NO.	TYPE	SIZE	INNER	MASTER
1190-003	Threaded	1/2"	10	100
1190-004	Threaded	3/4"	5	60
1190-005	Threaded	1"	5	40
1190-006	Threaded	1 1/4"	5	30
1190-007	Threaded	1 1/2"	4	24
1190-008	Threaded	2"	2	16
1190-503	Solder	1/2"	10	100
1190-504	Solder	3/4"	5	60
1190-505	Solder	1"	5	40



GATE VALVES - COMPRESSION - LEAD FREE

- Non rising stem, cast iron handle
- Meets NSF/ANSI 372 lead free standard
- 80°C maximum temperature, 200 PSI

PART NO.	TYPE	SIZE	INNER	MASTER
1190-803	Compression	1/2"	6	48
1190-804	Compression	3/4"	4	32



Threaded



Threaded with drain

STOP VALVES - LEAD FREE

- Cast iron handle
- Stop & Waste valves allow the draining of the non pressure side of valve when closed
- CSA, cUPC certified
- Meets NSF/ANSI 372 lead free standard
- -29° to 93°C temperature range, 125 PSI

PART NO.	TYPE	SIZE	INNER	MASTER
1195-003	Threaded	1/2"	12	72
1195-004	Threaded	3/4"	6	36
1195-103	Threaded with drain	1/2"	12	72
1195-104	Threaded with drain	3/4"	6	36
1195-503	Solder	1/2"	12	72
1195-504	Solder	3/4"	6	36
1195-603	Solder with drain	1/2"	12	72
1195-604	Solder with drain	3/4"	6	36
1195-703	Solder - Angle	1/2"	12	72
1195-704	Solder - Angle	3/4"	12	72



Solder



Solder with drain



Solder - Angle

Valves

NEW

STOP VALVES - PEX - LEAD FREE

- Cast iron handle
- For use in F1807 PEX systems
- CSA certified
- Meets NSF/ANSI 372 lead free standard



PART NO.	TYPE	SIZE	INNER	MASTER
1195-543	PEX	1/2"	12	72

STOP VALVES - COMPRESSION - LEAD FREE

- Cast iron handle
- Stop & Waste valves allow the draining of the non pressure side of valve when closed
- CSA, cUPC certified
- Meets NSF/ANSI 372 lead free standard
- 29° to 93°C temperature range, 125 PSI



PART NO.	TYPE	SIZE	INNER	MASTER
1195-513	Compression	1/2"	12	72
1195-514	Compression	3/4"	6	36
1195-613	Compression with drain	1/2"	12	72
1195-614	Compression with drain	3/4"	6	36

STOP VALVES - O-RING STEMS - LEAD FREE

- Solid brass construction
- Replaceable O-ring type stems
- Plastic triangular handles
- CSA, cUPC certified
- Meets NSF/ANSI 372 lead free standard
- -18° to 82°C temperature range, 125 PSI



PART NO.	TYPE	SIZE	INNER	MASTER
1395-503	Solder	1/2"	12	72
1395-504	Solder	3/4"	12	72
1395-603	Solder with drain	1/2"	12	72
1395-604	Solder with drain	3/4"	12	72

BOILER DRAINS - ANGLE BODY

- Solid brass construction
- 3/4" hose thread outlet
- CSA, cUPC certified
- Meets NSF 61-9 low lead standards
- -29° to 93°C temperature range, 125 PSI

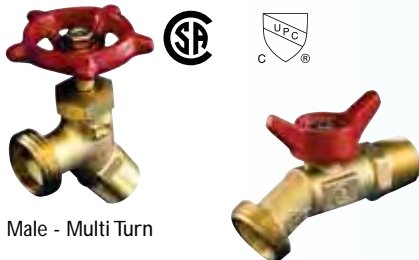

Male - Multi Turn



Male - Quarter Turn



PEX - Quarter Turn



F1960 PEX - Quarter Turn

NEW	1102-453	PEX - Quarter turn	1/2"	25	150
NEW	1102-473	F1960 PEX - Quarter turn	1/2"	25	150

† 1/2" Male boiler drains have combination 1/2" threaded and 1/2" copper sweat inlet connections.



Male Multi Turn



Male Quarter Turn



PEX Quarter Turn



F1960 PEX Quarter Turn

BOILER DRAINS - STRAIGHT BODY

- Heavy construction, cast iron handle
- 3/4" hose thread outlet
- CSA, cUPC certified
- Meets NSF 61-9 low lead standards
- -29° to 93°C temperature range, 125 PSI

PART NO.	TYPE	SIZE	INNER	MASTER
1102-003	Male † - Multi Turn	1/2"	12	72
1102-004	Male - Multi Turn	3/4"	12	72
1102-053	Male † - Quarter turn	1/2"	25	150
1102-054	Male - Quarter turn	3/4"	25	150
NEW 1102-063	PEX - Quarter Turn	1/2"	25	150
NEW 1102-073	F1960 PEX - Quarter Turn	1/2"	25	150

† 1/2" Male boiler drains have combination 1/2" threaded and 1/2" copper sweat inlet connections.



BOILER DRAINS - O-RING STEMS

- Solid brass construction
- Replaceable O-ring type stems
- Plastic triangular handles
- CSA certified
- Meets NSF 61-9 low lead standards
- -18° to 82°C temperature range, 125 PSI

PART NO.	TYPE	SIZE	INNER	MASTER
1382-043	Male †	1/2"	12	72
1382-044	Male	3/4"	12	72

† 1/2" Male boiler drains have combination 1/2" threaded and 1/2" copper sweat inlet connections.



BOILER DRAINS - PEX CONNECTION

- 3/4" hose thread outlet
- Cast iron handle
- CSA, cUPC certified
- Meets NSF 61-9 low lead standards
- -29° to 93°C temperature range, 125 PSI

PART NO.	TYPE	SIZE	INNER	MASTER
1102-653	PEX Inlet	1/2"	12	72



BOILER DRAINS - COMPRESSION CONNECTION

- 3/4" hose thread outlet
- Cast iron handle
- CSA, cUPC certified
- Meets NSF 61-9 low lead standards
- -29° to 93°C temperature range, 125 PSI

PART NO.	TYPE	SIZE	INNER	MASTER
1102-033	Compression Inlet	1/2"	12	72

NEW



BOILER DRAINS - WITH LOCKNUT

- Heavy brass construction
- 3/4" hose thread outlet, cast iron handle
- Extra long straight pipe thread inlet, larger than normal hex with added clearance at hose threads for mounting in a washing machine box
- CSA, cUPC certified
- Meets NSF 61-9 low lead standards
- -18° to 82°C temperature range, 125 PSI

PART NO.	TYPE	SIZE	INNER	MASTER
1102-903	Male w/Locknut †	1/2"	12	72

† 1/2" Male boiler drains have combination 1/2" threaded and 1/2" copper sweat inlet connections.



HOSE BIBBS - PUSH-FIT

- 3/4" hose thread outlet
- Permanent Install
- Easy quarter turn operation
- cUPC certified
- Meets NSF 61-9 low lead standards
- -18° to 82°C temperature range, 125 PSI

PART NO.	TYPE	SIZE	INNER	MASTER
1102-993	Male - Quarter turn	1/2"	12	72
1102-994	Male - Quarter turn	3/4"	12	72

NEW



DUAL WASHING MACHINE VALVES

- 3/4" hose thread outlets
- Hose threads comply with ANSI B2.4
- Pipe threads comply with ANSI B1.20.1
- Solder ends comply with ANSI B16.18

PART NO.	TYPE	SIZE	INNER	MASTER
1102-207	Threaded †	1/2"	1	24
1102-208	Solder	1/2"	1	24

† 1/2" Male inlet threads have combination 1/2" threaded and 1/2" copper sweat inlet connections.



HOSE BIBBS

- 3/4" hose thread outlet
- CSA, cUPC certified
- Meets NSF 61-9 low lead standards
- -29° to 93°C temperature range, 125 PSI

PART NO.	TYPE	SIZE	INNER	MASTER
1103-003	Male † - Multi turn	1/2"	12	72
1103-004	Male - Multi turn	3/4"	12	72
1103-053	Male † - Quarter turn	1/2"	25	150
1103-054	Male - Quarter turn	3/4"	25	150

† 1/2" Male boiler drains have combination 1/2" threaded and 1/2" copper sweat inlet connections.



Female Multi Turn Solder Multi Turn PEX Multi Turn



Female Quarter Turn Solder Quarter Turn



PEX Quarter Turn F1960 PEX Quarter Turn

SILLCOCKS

- Notched flange for stable installation
- 3/4" hose thread outlet
- Generally used as an outside faucet
- CSA, cUPC certified
- Meets NSF 61-9 low lead standards
- -18° to 82°C temperature range, 125 PSI

PART NO.	TYPE	SIZE	INNER	MASTER
1108-003	Female - Multi turn	1/2"	12	72
1108-004	Female - Multi turn	3/4"	12	72
1108-503	Solder - Multi turn	1/2" & 3/4"	12	72
NEW 1108-403	PEX - Multi turn	1/2"	12	72
1108-053	Female - Quarter turn	1/2"	20	80
1108-054	Female - Quarter turn	3/4"	20	80
1108-553	Solder - Quarter turn	1/2" & 3/4"	1	25
NEW 1108-653	PEX - Quarter turn	1/2"	12	72
NEW 1108-673	F1960 PEX - Quarter turn	1/2"	25	150



SILLCOCKS - PUSH-FIT

- Notched flange for stable installation
- 3/4" hose thread outlet
- Permanent install
- cUPC certified
- Meets NSF 61-9 low lead standards
- -18° to 82°C temperature range, 125 PSI

PART NO.	TYPE	SIZE	INNER	MASTER
1108-993	Push-Fit	1/2"	12	72

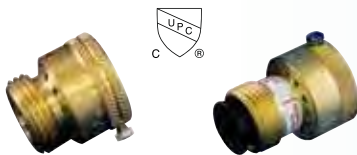

VACUUM BREAKERS

- Fits any 3/4" hose thread outlet
- Break off attachment screw for permanent installation
- cUPC certified
- -18° to 82°C temperature range, 125 PSI

PART NO.	TYPE	SIZE	INNER	MASTER
1108-904	Standard	3/4"	12	192
1108-922	Automatic Draining	3/4"	1	100



GARDEN HOSE VALVES

- Easy quarter turn operation
- CSA, cUPC certified
- Meets NSF 61-9 low lead standards
- -29° to 93°C temperature range, 125 PSI

PART NO.	TYPE	SIZE	INNER	MASTER
1487-344	3/4" Female x 3/4" Hose	3/4"	10	100

NEW

NEW

Valves

NON-FREEZE WALL HYDRANTS - QUARTER TURN - ANTI-SIPHON

- Lead free silver soldered construction
- 3/4" hose thread outlet
- Chrome plated body & tube, built in lockshield
- Notched flange for stable installation
- Built in backflow preventer, automatic draining
- Quarter turn operation makes positive shutoff easy
- CSA certified
- Meets NSF 61-9 low lead standards
- -18° to 82°C temperature range, 125 PSI



PART NO.	TYPE	SIZE	INNER	MASTER
1104-551	1/2" Male x 1/2" Solder	4"	1	20
1104-553	1/2" Male x 1/2" Solder	6"	1	20
1104-555	1/2" Male x 1/2" Solder	8"	1	20
1104-557	1/2" Male x 1/2" Solder	10"	1	20
1104-559	1/2" Male x 1/2" Solder	12"	1	20
1104-561	1/2" Male x 1/2" Solder	14"	1	20
1104-711	1/2" PEX	4"	1	20
1104-713	1/2" PEX	6"	1	20
1104-715	1/2" PEX	8"	1	20
1104-717	1/2" PEX	10"	1	20
1104-719	1/2" PEX	12"	1	20
1104-721	1/2" PEX	14"	1	20

NON-FREEZE WALL HYDRANTS - ANTI-SIPHON

- Lead free silver soldered construction
- 3/4" hose thread outlet
- Chrome plated body & tube, built in lockshield
- Notched flange for stable installation
- Built in backflow preventer, automatic draining
- CSA certified
- Meets NSF 61-9 low lead standards



PART NO.	TYPE	SIZE	INNER	MASTER
1392-040	1/2" Male x 1/2" Solder	4"	2	20
1392-060	1/2" Male x 1/2" Solder	6"	2	20
1392-080	1/2" Male x 1/2" Solder	8"	2	20
1392-100	1/2" Male x 1/2" Solder	10"	2	20
1392-120	1/2" Male x 1/2" Solder	12"	2	20
1392-140	1/2" Male x 1/2" Solder	14"	2	20
1393-080	1/2" PEX	8"	2	20
1393-100	1/2" PEX	10"	2	20
1393-120	1/2" PEX	12"	2	20
1393-140	1/2" PEX	14"	2	20

NON-FREEZE WALL HYDRANTS - ANTI-SIPHON PUSH-FIT



- Lead free silver soldered construction
- 3/4" hose thread outlet
- Notched flange for stable installation
- Built in backflow preventer, automatic draining
- cUPC certified
- Meets NSF 61-9 low lead standards
- -18° to 82°C temperature range, 125 PSI

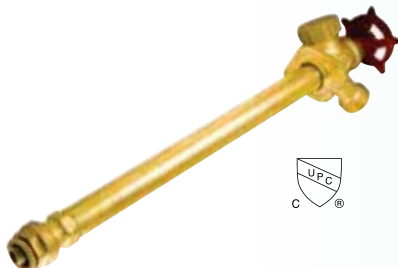

PART NO.	TYPE	SIZE	INNER	MASTER
1394-080	1/2" Push-Fit	8"	6	24
1394-100	1/2" Push-Fit	10"	6	24
1394-120	1/2" Push-Fit	12"	6	24
1394-140	1/2" Push-Fit	14"	6	24

Valves

NON-FREEZE WALL HYDRANTS

- Chrome plated body and tube
- Notched flange for stable installation
- Built in lockshield, 3/4" hose thread outlet
- Lead free silver soldered construction
- CSA certified
- Meets NSF 61-9 low lead standards



PART NO.	TYPE	SIZE	INNER	MASTER
1390-040	1/2" Male x 1/2" Solder	4"	2	20
1390-060	1/2" Male x 1/2" Solder	6"	2	20
1390-080	1/2" Male x 1/2" Solder	8"	2	20
1390-100	1/2" Male x 1/2" Solder	10"	2	20
1390-120	1/2" Male x 1/2" Solder	12"	2	20
1390-140	1/2" Male x 1/2" Solder	14"	2	20

NON-FREEZE WALL HYDRANTS - HOT & COLD

NEW

- Chrome plated body and tube
- Notched flange for stable installation
- Built in lockshield, 3/4" hose thread outlet
- Lead free silver soldered construction
- Meets NSF 61-9 low lead standards



PART NO.	TYPE	SIZE	INNER	MASTER
1391-080	1/2" Male x 1/2" Solder	8"	1	10
1391-100	1/2" Male x 1/2" Solder	10"	1	10
1391-120	1/2" Male x 1/2" Solder	12"	1	10

NON-FREEZE WALL HYDRANTS - HEAVY DUTY

- Rough brass body & tube, built in lockshield
- Notched flange for stable installation
- Solid brass stem, 3/4" hose thread outlet
- Lead free silver soldered construction
- CSA certified
- Meets NSF 61-9 low lead standards



PART NO.	TYPE	SIZE	INNER	MASTER
1395-080	1/2" Male x 1/2" Solder	8"	2	20
1395-100	1/2" Male x 1/2" Solder	10"	2	20
1395-120	1/2" Male x 1/2" Solder	12"	2	20
1395-140	1/2" Male x 1/2" Solder	14"	2	20
1396-100	3/4" Male x 1/2" Female	10"	2	20
1396-120	3/4" Male x 1/2" Female	12"	2	20
1396-140	3/4" Male x 1/2" Female	14"	2	20

Valves

SWING CHECK VALVES - LEAD FREE

- Brass body with Teflon washer
- Brass disk
- Meets NSF/ANSI 372 lead free standard
- -18° to 82°C temperature range, 200 PSI



PART NO.	TYPE	SIZE	INNER	MASTER
1191-003	Threaded	1/2"	10	100
1191-004	Threaded	3/4"	5	60
1191-005	Threaded	1"	5	40
1191-006	Threaded	1 1/4"	5	30
1191-007	Threaded	1 1/2"	4	24
1191-008	Threaded	2"	2	16
1191-503	Solder	1/2"	10	100
1191-504	Solder	3/4"	5	60
1191-505	Solder	1"	5	40

IN LINE CHECK VALVES - LEAD FREE

- Spring loaded bronze poppet
- Can be used horizontally or vertically
- Meets NSF/ANSI 372 lead free standard
- 82°C maximum temperature, 200 PSI



PART NO.	TYPE	SIZE	INNER	MASTER
1191-303	Threaded	1/2"	1	72
1191-304	Threaded	3/4"	1	48
1191-305	Threaded	1"	1	36
1191-306	Threaded	1 1/4"	1	24
1191-307	Threaded	1 1/2"	1	24
1191-308	Threaded	2"	1	12

FOOT VALVES - LEAD FREE

- Stainless steel strainer
- Spring loaded bronze poppet
- Large flow area
- Meets NSF/ANSI 372 lead free standard
- 82°C maximum temperature, 200 PSI



PART NO.	SIZE	INNER	MASTER
1590-003	1/2"	50	200
1590-004	3/4"	35	105
1590-005	1"	10	50
1590-006	1 1/4"	5	50
1590-007	1 1/2"	15	30
1590-008	2"	8	32

DUAL CHECK BACKFLOW PREVENTERS - LEAD FREE

- Manufactured in an ISO 9002 facility
- Continuous pressure use, stainless steel springs
- Prevents the backflow of water
- CSA certified
- Meets NSF/ANSI 372 lead free standard
- Pressure range 25 to 175 PSI



PART NO.	TYPE	SIZE	INNER	MASTER
1191-404	Standard	3/4"	1	25
1191-405	Standard	1"	1	25

Valves

IN LINE CHECK VALVES - PVC

- O-ring seal, not for use with compressed air
- Stainless steel spring loaded poppet
- Fits schedule 40 & 80 pipe, white colour
- Rated at 200 PSI at 22°C



PART NO.	TYPE	SIZE	INNER	MASTER
1101-103	Threaded	1/2"	10	120
1101-104	Threaded	3/4"	10	120
1101-105	Threaded	1"	8	80
1101-106	Threaded	1 1/4"	6	60
1101-107	Threaded	1 1/2"	4	60
1101-108	Threaded	2"	4	40
1101-603	Solvent	1/2"	10	120
1101-604	Solvent	3/4"	10	120
1101-605	Solvent	1"	8	80
1101-606	Solvent	1 1/4"	6	60
1101-607	Solvent	1 1/2"	4	60
1101-608	Solvent	2"	4	40

OIL TANK VALVE - BRASS

- Ball valve design
- Easy quarter turn operation
- CSA certified
- -18° to 82°C temperature range, 125 PSI



PART NO.	TYPE	INNER	MASTER
1109-243	3/8" MIP x 1/2" MIP - Angle	10	40

BARREL & DRUM FAUCETS

- Pipe threads comply with ANSI B1.20.1
- 3/4" MIP inlet



PART NO.	TYPE	SIZE	INNER	MASTER
1109-204	Plain Outlet - Zamac	3/4"	6	72
1109-224	Hose Thread Outlet - Bronze	3/4"	6	36

RADIATOR VALVES - BRASS

- Adjustable packing
- Rising stem
- For low pressure steam or circulated hot water
- 82°C maximum temperature, 60 PSI



PART NO.	SIZE	INNER	MASTER
1109-303	1/2"	6	60
1109-304	3/4"	6	48

FLOAT VALVES - BRONZE

- Dual inlet thread for connecting pipe & locknut
- Machined flange for support against tank wall
- High tensile serrated arms
- Replaceable seals, locknut & washer included



PART NO.	TYPE	SIZE	INNER	MASTER
1109-813	Male Inlet - Pipe Thread Outlet	1/2"	12	72
1109-814	Male Inlet - Pipe Thread Outlet	3/4"	6	36

TOILET TANK ANTI-SWEAT VALVES

- Hot water adjusting screw allows hot water to be shut off or regulated
- Brass construction
- Three way installation: Threaded 1/2" IPS, Solder 1/2", Compression 1/2"



PART NO.	SIZE	INNER	MASTER
1109-503	1/2"	1	40



1986-702 1990-102 1990-202 / 302



1990-502 1990-601 / 602



1991-102 1991-202 / 302 1991-432



1991-502 1991-601 / 602 1991-612



1991-622 1991-702



1991-712 1991-902

SUPPLY STOPS - QUARTER TURN - LEAD FREE

- Ball valve design
- Chrome plated, solid brass body
- Easy quarter turn operation
- cUPC certified
- Meets NSF/ANSI 372 lead free standard
- 80°C maximum temperature, 200 PSI

PART NO.	INLET	OUTLET	INNER	MASTER
ANGLE				
1990-102	5/8" O.D. Compression	3/8" O.D. Comp.	25	200
1990-202	3/8" FIP	3/8" O.D. Comp.	25	200
1990-302	1/2" FIP	3/8" O.D. Comp.	25	200
1990-502	1/2" Solder	3/8" O.D. Comp.	25	200
NEW 1990-601	1/2" PEX	1/4" O.D. Comp.	25	200
1990-602	1/2" PEX	3/8" O.D. Comp.	25	200
NEW 1986-702	1/2" F1960 PEX	3/8" O.D. Comp.	25	200

STRAIGHT

1991-102	5/8" O.D. Compression	3/8" O.D. Comp.	25	200
1991-202	3/8" FIP	3/8" O.D. Comp.	25	200
1991-302	1/2" FIP	3/8" O.D. Comp.	25	200
NEW 1991-432	1/2" FIP Swivel	3/8" O.D. Comp.	25	200
1991-502	1/2" Solder	3/8" O.D. Comp.	25	200
NEW 1991-601	1/2" PEX	1/4" O.D. Comp.	25	200
1991-602	1/2" PEX	3/8" O.D. Comp.	25	200
1991-612	1/2" PEX	1/2" PEX	25	200
1991-622	1/2" PEX with drain	1/2" PEX	25	200
1991-702	1/2" F1960 PEX	3/8" O.D. Comp.	25	200
NEW 1991-712	1/2" F1960 PEX	1/2" F1960 PEX	25	200
NEW 1991-902	3/8" Female Compression	3/8" O.D. Comp.	25	200

SUPPLY STOPS - QUARTER TURN PUSH-FIT - LEAD FREE



- Ball valve design
- Chrome plated, solid brass body
- Easy quarter turn operation
- Joins copper, CPVC and PEX tubing in any combination
- Easy installation - No solder, flux or glues required
- cUPC certified
- Meets NSF/ANSI 372 lead free standard

PART NO.	INLET	OUTLET	BAG	INNER	MASTER
ANGLE					
1490-801	1/2" Push-Fit	1/4" O.D. Comp.	5	25	200
1490-802	1/2" Push-Fit	3/8" O.D. Comp.	5	25	200
1490-933	1/2" Push-Fit	1/2" Push-Fit	5	25	200
STRAIGHT					
1491-801	1/2" Push-Fit	1/4" O.D. Comp.	5	25	200
1491-802	1/2" Push-Fit	3/8" O.D. Comp.	5	25	200
1491-933	1/2" Push-Fit	1/2" Push-Fit	5	25	200



NEW

WATER HAMMER ARRESTER VALVES QUARTER TURN - LEAD FREE

- Ball valve design
- Chrome plated, solid brass body
- Easy quarter turn operation
- Integral water hammer arrester
- cUPC certified
- Meets NSF/ANSI 372 lead free standard



PART NO.	INLET	OUTLET	INNER	MASTER
ANGLE				
1988-102	5/8" O.D. Comp.	3/8" O.D. Comp.	5	50
1988-502	1/2" Solder	3/8" O.D. Comp.	5	50
1988-602	1/2" PEX	3/8" O.D. Comp.	5	50
1988-702	1/2" F1960 PEX	3/8" O.D. Comp.	5	50
STRAIGHT				
1989-102	5/8" O.D. Comp.	3/8" O.D. Comp.	5	50
1989-502	1/2" Solder	3/8" O.D. Comp.	5	50
1989-602	1/2" PEX	3/8" O.D. Comp.	5	50
1989-702	1/2" F1960 PEX	3/8" O.D. Comp.	5	50

NEW

SUPPLY STOP BALL VALVES - QUARTER TURN TEE - LEAD FREE

- Chrome plated solid brass body
- Brass stem and metal handles on solder inlet valves, Celcon® stem and plastic handle on threaded or compression inlet valves
- CSA, cUPC certified
- Meets NSF/ANSI 372 lead free standard
- -29° to 93°C temperature range, 125 PSI

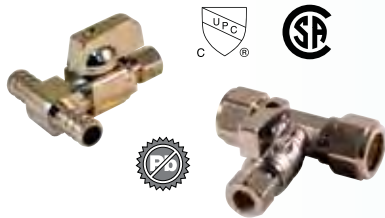

PART NO.	INLET	OUTLET	INNER	MASTER
1989-331	1/2" PEX x 1/2" PEX	1/4" O.D. Comp.	25	200
1989-332	1/2" PEX x 1/2" PEX	3/8" O.D. Comp.	25	200
1989-551	5/8" O.D. Comp. x 5/8" O.D. Comp.	1/4" O.D. Comp.	25	200
1989-552	5/8" O.D. Comp. x 5/8" O.D. Comp.	3/8" O.D. Comp.	25	200

SUPPLY STOPS - LEAD FREE

- Chrome plated solid brass body
- Brass stem and metal handles on solder inlet valves, Celcon® stem and plastic handle on threaded or compression inlet valves
- cUPC certified
- Meets NSF/ANSI 372 lead free standard
- 82°C maximum temperature, 125 PSI



PART NO.	INLET	OUTLET	INNER	MASTER
ANGLE				
1912-215	3/8" FIP	3/8" O.D. Comp.	25	100
1912-217	1/2" FIP	3/8" O.D. Comp.	25	100
1912-219	1/2" Solder	3/8" O.D. Comp.	25	100
1912-319	5/8" O.D. Compression	3/8" O.D. Comp.	25	100
1912-339	5/8" O.D. Compression	1/2" O.D. Comp.	25	100
STRAIGHT				
1912-210	3/8" FIP	3/8" O.D. Comp.	25	100
1912-212	1/2" FIP	3/8" O.D. Comp.	25	100
1912-214	1/2" Solder	3/8" O.D. Comp.	25	100
1912-314	5/8" O.D. Compression	3/8" O.D. Comp.	25	100
1912-334	5/8" O.D. Compression	1/2" O.D. Comp.	25	100

FAUCETS



FAUCETS	PAGE
BAR FAUCETS	2-7
BATH FAUCETS	2-10
COMPRESSION FAUCETS	2-7
DRINKING WATER FAUCETS	2-8
KITCHEN FAUCETS	
SINGLE HANDLE	2-5
TWO HANDLE	2-6
LAUNDRY TRAY FAUCETS	2-8
LAVATORY FAUCETS	
SINGLE HANDLE	2-1
TWO HANDLE	2-2, 2-3
ROMAN TUB FAUCETS	2-4
SHOWER KITS	2-10
SHOWER STALL FAUCETS	2-10
SINGLE BASIN FAUCETS	2-9
SINGLE KITCHEN FAUCETS	2-9
TUB & SHOWER FAUCETS - PRESSURE BALANCING	2-4
UTILITY SHOWERS	2-10
WALLMOUNT FAUCETS	2-9
WASHING MACHINE FAUCETS	2-8

NEW



SINGLE HANDLE LAVATORY FAUCETS - LEAD FREE

- Single lever handle
- Lead free waterways
- Ceramic cartridge
- With pop-up
- cUPC certified
- Meets NSF/ANSI 372 lead free standard

PART NO.	FINISH	MASTER
2401-104	Chrome	6



- Acrylic Handle
- Lead free waterways
- 4" centre distance
- Stainless steel ball washerless design
- cUPC certified
- Meets NSF/ANSI 372 lead free standard

PART NO.	FINISH	SIZE	MASTER
2191-104	Chrome	4"	6



- Braided stainless steel connection lines
- Lead free waterways
- 4" centre distance
- Stainless steel ball washerless design
- cUPC certified
- Meets NSF/ANSI 372 lead free standard

PART NO.	FINISH	MASTER
2192-330	Chrome, metal handle, less pop-up	6
2192-331	Chrome, metal handle, with pop-up	6



- Metal handle
- Lead free waterways
- Ceramic cartridge
- 4" centre distance
- Braided stainless steel connection lines
- With brass pop-up
- cUPC certified
- Meets NSF/ANSI 372 lead free standard

PART NO.	FINISH	MASTER
2191-829	Chrome	6
2191-830	PVD brushed nickel	6

NEW



TWO HANDLE LAVATORY FAUCETS - LEAD FREE

- Two lever handles
- Brass / plastic hybrid waterways
- Washerless cartridges
- Easy installation
- cUPC certified
- Meets NSF/ANSI 372 lead free standard

PART NO.	FINISH	MASTER
2401-604	Chrome	6
2401-704	Chrome - with pop-up	6
2401-705	Brushed Nickel - with pop-up	6



- Acrylic handles
- Brass / plastic hybrid waterways
- 4" centre distance
- Quarter turn washerless cartridge
- cUPC certified
- Meets NSF/ANSI 372 lead free standard

PART NO.	FINISH	MASTER
2191-604	Chrome	6



- Acrylic handles
- Brass / plastic hybrid waterways
- 4" centre distance
- Quarter turn washerless cartridge
- cUPC certified
- Meets NSF/ANSI 372 lead free standard

PART NO.	FINISH	MASTER
2192-300	Chrome	6



- Rounded metal handles
- Brass / plastic hybrid waterways
- 4" centre distance
- Quarter turn washerless cartridge
- cUPC certified
- Meets NSF/ANSI 372 lead free standard

PART NO.	FINISH	MASTER
2192-304	Chrome	6

Lavatory Faucets



- Interchangeable handles
- Brass / plastic hybrid waterways
- 4" centre distance

- Quarter turn washerless cartridge
- cUPC certified
- Meets NSF/ANSI 372 lead free standard

PART NO.	FINISH	MASTER
2192-307	Chrome	6



- ADA metal blade handles
- Brass / plastic hybrid waterways
- 4" centre distance

- Quarter turn washerless cartridge
- cUPC certified
- Meets NSF/ANSI 372 lead free standard

PART NO.	FINISH	MASTER
2192-311	Chrome	6



- Decorative metal lever handles
- Brass / plastic hybrid waterways
- 4" centre distance
- Quarter turn ceramic cartridge

- Complete with brass pop-up
- cUPC certified
- Meets NSF/ANSI 372 lead free standard

PART NO.	FINISH	MASTER
2191-826	Chrome	6
2192-750	Chrome	6
2192-752	PVD brushed Nickel	6

WIDESPREAD LAVATORY FAUCETS - LEAD FREE



- Decorative metal lever handles
- Brass / plastic hybrid waterways
- 6" to 8" centre distance
- Quarter turn ceramic cartridge

- Complete with brass pop-up
- cUPC certified
- Meets NSF/ANSI 372 lead free standard

PART NO.	FINISH	MASTER
2192-325	Chrome	6
2192-336	PVD brushed nickel	6

Bath Faucets



PRESSURE BALANCING TUB & SHOWER FAUCETS

- Metal handle
- Protection against scalding
- Pressure balancing valve with integral stops
- Maintains water temperature +/- 1.7°C
- CSA certified

PART NO.	FINISH	MASTER
2122-275	Chrome, tub & shower	6
2122-276	Chrome, shower only	6
2122-277	PVD brushed nickel, tub & shower	6
2122-278	PVD brushed nickel, shower only	6
2122-281	Brushed bronze, tub & shower, antique look shower head	6



ROMAN TUB FAUCETS

- Acrylic handles
- Brass waterways
- 8" to 12" centre distance
- Quarter turn ceramic cartridge
- Braided stainless steel connection lines
- CSA certified
- Meets NSF 61-9 low lead standards

PART NO.	FINISH	MASTER
2122-219	Chrome	6



- Metal lever handles
- Brass waterways
- 8" to 12" centre distance
- Quarter turn ceramic cartridge
- Braided stainless steel connection lines
- CSA certified

PART NO.	FINISH	MASTER
2122-223	Chrome	6
2122-303	PVD brushed nickel	6



- Decorative metal lever handles
- Brass waterways
- 8" to 12" centre distance
- Quarter turn ceramic cartridge
- Braided stainless steel connection lines
- CSA certified

PART NO.	FINISH	MASTER
2122-287	Chrome	6
2122-288	PVD brushed nickel	6

NEW



SINGLE HANDLE KITCHEN FAUCETS - LEAD FREE

- Single lever handle
- Lead free waterways
- Ceramic cartridge
- Easy Installation
- cUPC certified
- Meets NSF/ANSI 372 lead free standard

PART NO.	FINISH	MASTER
2402-108	Chrome, less spray	6



- Metal lever handle
- Lead free waterways
- 8" centre distance
- Washerless cartridge
- cUPC certified
- Meets NSF/ANSI 372 lead free standard

PART NO.	FINISH	MASTER
2192-108	Chrome, less spray	6



- Metal lever handle
- Lead free waterways
- 8" centre distance
- Washerless cartridge
- Braided stainless steel connection lines
- cUPC certified
- Meets NSF/ANSI 372 lead free standard

PART NO.	FINISH	MASTER
2192-417	Chrome	6
2192-419	Chrome, with deck mounted spray	6



- Metal lever handle
- Lead free waterways
- 8" centre distance
- Ceramic cartridge
- Braided stainless steel connection lines
- cUPC certified
- Meets NSF/ANSI 372 lead free standard

PART NO.	FINISH	MASTER
2192-796	Chrome, less spray	6
2192-797	PVD stainless steel, less spray	6



- Metal lever handle
- Lead free waterways
- 8" centre distance
- Ceramic disk cartridge
- Braided stainless steel connection lines
- Pull out spray
- cUPC certified
- Meets NSF/ANSI 372 lead free standard

PART NO.	FINISH	MASTER
2192-424	Chrome	6
2192-426	Brushed nickel	6



Kitchen Faucets

NEW

TWO HANDLE KITCHEN FAUCETS - LEAD FREE



- Two lever handles
- Brass / plastic hybrid waterways
- Ceramic cartridges
- Easy installation
- cUPC certified
- Meets NSF/ANSI 372 lead free standard

PART NO.	FINISH	MASTER
2402-208	Chrome, High-Arch Spout	6



- Acrylic handles
- Brass / plastic hybrid waterways
- 8" centre distance
- Quarter turn washerless cartridge
- cUPC certified
- Meets NSF/ANSI 372 lead free standard

PART NO.	FINISH	MASTER
2192-608	Chrome, less spray	8" 6



- Acrylic handles
- Brass / plastic hybrid waterways
- 8" centre distance
- Quarter turn washerless cartridge
- cUPC certified
- Meets NSF/ANSI 372 lead free standard

PART NO.	FINISH	MASTER
2192-400	Chrome, less spray	6



- Round metal handles
- Brass / plastic hybrid waterways
- 8" centre distance
- Quarter turn washerless cartridge
- cUPC certified
- Meets NSF/ANSI 372 lead free standard

PART NO.	FINISH	MASTER
2192-402	Chrome, less spray	6



- Interchangeable handles
- Brass / plastic hybrid waterways
- 8" centre distance
- Quarter turn washerless cartridge
- cUPC certified
- Meets NSF/ANSI 372 lead free standard

PART NO.	FINISH	MASTER
2192-404	Chrome, less spray	6



- Metal ADA blade handles
- Brass / plastic hybrid waterways
- 8" centre distance
- Quarter turn washerless cartridge
- cUPC certified
- Meets NSF/ANSI 372 lead free standard

PART NO.	FINISH	MASTER
2192-407	Chrome, less spray	6



- Interchangeable handles
- Brass / plastic hybrid waterways
- 8" centre distance
- Quarter turn washerless cartridge
- Hi-rise spout
- cUPC certified
- Meets NSF/ANSI 372 lead free standard

PART NO.	FINISH	MASTER
2192-410	Chrome, less spray	6

JOHN L. SCHULTZ LTD.

© 2015



BAR FAUCETS - LEAD FREE

- Two lever handles
- Brass / plastic hybrid waterways
- 4" centre distance
- Quarter turn washerless cartridge
- Hi-rise spout
- cUPC certified
- Meets NSF/ANSI 372 lead free standard

PART NO.	FINISH	MASTER
2192-431	Chrome	6



- Acrylic handles
- Brass / plastic hybrid waterways
- 4" centre distance
- Quarter turn washerless cartridge
- Hi-rise spout
- cUPC certified
- Meets NSF/ANSI 372 lead free standard

PART NO.	FINISH	MASTER
2192-430	Chrome	6



- Metal ADA blade handles
- Brass / plastic hybrid waterways
- 4" centre distance
- Quarter turn washerless cartridge
- Hi-rise spout
- cUPC certified
- Meets NSF/ANSI 372 lead free standard

PART NO.	FINISH	MASTER
2192-432	Chrome	6



COMPRESSION FAUCETS

- Round metal handles
- Emco style
- Compression cartridge

PART NO.	FINISH	MASTER
2381-210	Chrome, lavatory faucet	12
2381-216	Chrome, kitchen faucet, less spray	12

Specialty Faucets

LAUNDRY TRAY FAUCETS



- Heavy cast body with drain plug
- Spout has 3/4" hose thread outlet
- 1/2" threaded or sweat connection
- One red, one blue plastic handles
- cUPC certified

PART NO.	TYPE	INNER	MASTER
2125-005	Heavy Duty	1	24

LAUNDRY TRAY FAUCETS



- Chrome plated, deck mount
- Quarter turn washerless cartridge
- Includes aerator and threaded hose adapter
- Metal handles
- 6" tubular spout
- 4" centre distance
- cUPC certified

PART NO.	TYPE	SIZE	INNER	MASTER
2125-503	Standard	4"	1	12
2399-100	With drip connection	4"	1	12

WASHING MACHINE FAUCETS - CONCEALED INSTALLATION



- Dual outlets in casting allows installation of air chamber, eliminating possibility of water hammer
- Body of the faucet is completely concealed behind the finished wall
- All brass cartridge valve with replaceable seats
- Reversible installation to accommodate top or bottom water supply
- Two brass 1/2" copper to 3/4" hose thread outlet elbows included
- cUPC certified

PART NO.	FINISH	MASTER
2125-444	Chrome	10

WASHING MACHINE FAUCETS - WALLMOUNT INSTALLATION



- All brass cartridge valve with replaceable seats
- Two brass 1/2" copper to 3/4" hose thread outlet elbows included
- Designed for installation outside of finished wall
- Durable ABS plastic cover, paintable with latex
- Faucet can be installed with hot and cold piping from bottom, top or side of faucet.
- cUPC certified

PART NO.	FINISH	MASTER
2125-554	Chrome	6
2125-888	Elbow for 125-444/554	36

DRINKING WATER FAUCETS - LEAD FREE



- Brass body, chrome plated
- Touch or continuous flow modes
- 1/4" & 3/8" compression inlet connections
- Stainless steel control stem
- cUPC certified
- Meets NSF/ANSI 372 lead free standard

PART NO.	SIZE	INNER	MASTER
2190-004	1/4" - 3/8"	1	24

Specialty Faucets



SINGLE BASIN FAUCETS - LEAD FREE

- Brass construction, chrome plated
- Each faucet packed with both hot and cold buttons
- Replaceable seat and stem
- Meets NSF/ANSI 372 lead free standard

PART NO.	TYPE	SIZE	INNER	MASTER
2190-003	Standard	1/2"	1	36
2190-005	Heavy duty	1/2"	1	30
2190-006	Heavy duty, self closing	1/2"	1	24



WALLMOUNT FAUCETS - LEAD FREE

- Brass body, chrome plated
- 1/2" female connections
- 8" centre distance
- Quarter turn ceramic cartridge
- Soap dish
- Meets NSF/ANSI 372 lead free standard

PART NO.	TYPE	SIZE	INNER	MASTER
2193-009	8" Tubular Spout	8"	1	12



WALLMOUNT FAUCETS - LEAD FREE

- Brass body, chrome plated
- 1/2" female connections
- 6" to 10" adjustable centre distance
- Compression
- Soap dish
- Meets NSF/ANSI 372 lead free standard

PART NO.	TYPE	SIZE	INNER	MASTER
2193-610	6" Cast Spout	6" - 10"	1	12



SINGLE KITCHEN SINK FAUCETS - LEAD FREE

- Chrome plated
- Tee handle, replaceable washer
- Meets NSF/ANSI 372 lead free standard

PART NO.	TYPE	SIZE	INNER	MASTER
1903-190	Male - Plain Outlet	1/2"	6	72
1903-191	Male - Hose Thread Outlet	1/2"	6	72
1903-194	Male - Plain Outlet †	1/2"	6	72

† Adjustable flange.

1/2" valve has combination 1/2" threaded & 1/2" copper sweat inlet connections.





BATH FAUCETS

- Brass body
- Chrome plated
- Replaceable seats & stem
- 33/8" centre distance

PART NO.	TYPE	SIZE	INNER	MASTER
2123-003	Top handle	33/8"	1	24
2123-096	Coupling elbow	1/2"	12	144



SHOWER STALL FAUCETS

- Brass body, chrome plated trim
- Acrylic handles, 33/8" centre distance
- Can be used with bottom or top water supply

PART NO.	TYPE	SIZE	INNER	MASTER
2126-003	With Shower Head Assembly	33/8"	1	24



UTILITY SHOWERS

- Chrome plated, brass body
- Galvanized riser, shower head and soap dish
- Union inlets are combination 1/2" threaded or sweat connections

PART NO.	SIZE	INNER	MASTER
2126-005	3"	1	6



ADD-ON SHOWER KITS

- Complete with diverter bathcock, risers, shower head, wall and ceiling supports, 24" x 42" curtain frame, all necessary hardware, & instructions
- All parts are chrome plated
- Individually boxed
- Converts any old style "bath on legs" into a bath/shower combination

PART NO.	TYPE	MASTER
3275-100	Add-on Shower kit	1

SPECIALTIES



PLUMBING SPECIALTIES	PAGE	PLUMBING SPECIALTIES	PAGE
ACCESS PANELS	3-11	PLUMBER'S SANDCLOTH	3-25
ACRYLIC TUB SEAL	3-24	PLUNGERS	3-15
ALUMINUM FOIL TAPE	3-25	PRIMER CLEANER - CLEAR, PURPLE	3-28
AMCO C-FLUX	3-25	PVC DRAIN RINGS AND COVERS	3-7
BAR SINK STRAINERS	3-9	PVC UNIONS	3-19
BATH WASTE & OVERFLOWS	3-15	REPLACEMENT BASKETS	3-8
BIN BOXES	3-26	ROOF FLASHINGS	3-16
BRUSHES - FITTING, TUBE & ACID	3-25	SADDLE VALVES	3-18
CLOSET BOLTS	3-13	SEWER STOPS	3-7
CLOSET BOWL GASKETS	3-14	SHIELDED TRANSITION COUPLINGS	3-6
CLOSET FLANGE EXTENSION KITS	3-13	SHOWER DRAINS	3-9 to 3-11
CLOSET FLOOR FLANGES	3-13	SHOWER HEADS	3-11
COLD WEATHER FAUCET COVER	3-25	SHOWER PAN LINERS	3-16
CONTAINERS - EMPTY WITH BRUSH	3-28	SHOWER ROD FLANGES	3-20
DIELECTRIC UNIONS	3-17	SHOWER STALL ELBOWS	3-20
DRAIN COVERS	3-7	SILICONE RUBBER SEALANT	3-24
DRAIN HOSES	3-21	SINK TAILPIECES - BRASS	3-8
HIGH PRESSURE, NON PRESSURE, PREFORMED		SLOAN FLUSH VALVE REPAIR PARTS	3-26
DUCT TAPE	3-25	SOLDERING PASTE	3-24
DUPLEX STRAINERS	3-9	SOLVENT CEMENTS	3-27, 3-28
EPOXY PUTTY	3-24	ABS, PVC, TRANSITION, MULTI-USE	
ESCUTCHEON PLATES	3-3	SPANNER FLANGES	3-13
EZ CONNECT ADAPTERS	3-18	SUMP PUMP & SEWAGE PUMP CHECK VALVES	3-7
FAUCET & VALVE GREASE	3-24	SUPPLY FITTINGS	3-3
FLEX SEAL COUPLINGS	3-4, 3-5	SUSPENSION STRAP	3-16
FLEXIBLE CONNECTORS	3-2, 3-3	TANK BOLT KITS - BRASS	3-14
FLEXIBLE FITTINGS	3-5	TANK TO BOWL GASKETS	3-14
FLEXIBLE GAS CONNECTORS	3-18	TEFLON TAPE	3-16
FLEXIBLE P-TRAP	3-5	TEST PLUGS	3-6
FLOOR AND CEILING PLATES	3-19	TFE PASTE	3-23
FURNACE CEMENT	3-24	TOILET TANK FILL VALVES	3-14
GENERAL PURPOSE DRAINS	3-10	TOILET TANK FLOATS	3-14
HANDIPLUGS	3-17	TORQUE WRENCHES	3-6
ICE MAKE BOXES	3-1	TOUCH-UP PAINT	3-22
ICE MAKER / HUMIDIFIER INSTALLATION KITS	3-18	TRANSITION COUPLINGS	3-7
INSTALLATION KITS	3-22	TRAP CONNECTORS	3-19
TOILETS, FAUCETS, DISHWASHERS		TRAP VENTS	3-20
JUST FOR COPPER GLUE	3-17	TUB & SHOWER FAUCET TRIM KITS	3-11
KITCHEN SINK STRAINERS	3-8, 3-9	TUB SPOUTS	3-11
LAUNDRY TUB STRAINERS	3-9	TWO HOLE TUBE STRAPS	3-17
MAID-O-MIST	3-29, 3-30	UTILITY DRAINS / CLEANOUTS	3-10
MECHANICAL JOINT COUPLINGS	3-6	WASHING MACHINE BOXES	3-1
MECHANICAL POP-UP DRAINS	3-12	WASHING MACHINE HOSES	3-21
MOUNTING PLATES	3-20	WATER HAMMER ARRESTERS	3-1
P.O. PLUGS	3-12	WATER HEATER CONNECTORS	3-3
PIPE THREAD COMPOUND	3-23	WATER HEATER EARTHQUAKE RESTRAINTS	3-20
PIPE THREAD STICK	3-23	WATER HEATER PANS	3-26
PLASTIC BALLCOCKS	3-14	WAX GASKETS	3-23
PLUMBER'S PUTTY	3-23	WOBBLY TOILET REPAIR KITS	3-13

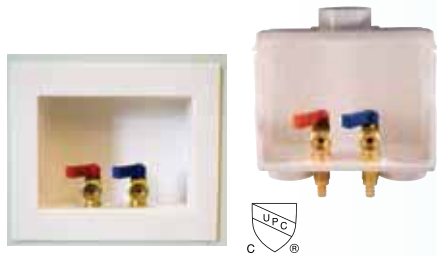

WASHING MACHINE & ICE MAKER BOXES

- Dual drain washer box
- Extended mounting flange
- One piece box and flange design needs no additional support
- Contour box design allows easy valve access
- Snap-on frame accommodates up to 3/4" drywall
- Prevents supply lines from crossing P-trap
- cUPC certified

PART NO.	TYPE	INNER	MASTER
WASHING MACHINE			
3125-600	Box only	1	10
3125-605	Box with 1/2" solder valves	1	10
3125-625	Box with 1/2" PEX valves	1	10
NEW 3125-630	Box with 1/2" F1960 PEX valves	1	10
WASHING MACHINE WITH ARRESTERS			
NEW 3125-650	Box with 1/2" PEX arrester valves	1	10
NEW 3125-660	Box with 1/2" F1960 PEX arrester valves	1	10
NEW 3125-675	Box with 1/2" solder arrester valves	1	10
ICE MAKER			
NEW 3125-700	Box only	1	10
3125-720	Box with 1/2" PEX x 1/4" O.D. Comp. Lead Free Valves	1	10
NEW 3125-775	Box with 1/2" PEX x 1/4" O.D. Comp. Lead Free Arrester Valves	1	10



WATER HAMMER ARRESTERS - LEAD FREE

- Dual o-ring piston
- Pressurized air cushion
- Can be installed at any angle
- cUPC certified
- Meets NSF/ANSI 372 lead free standard

PART NO.	TYPE	SIZE	INNER	MASTER
3955-003	MIP	1/2"	30	180
3955-033	PEX x PEX	1/2"	30	120
3955-053	PEX	1/2"	30	120
3955-142	Fem. Comp x O.D. Comp.	3/8"	25	75
3955-503	Male Solder	1/2"	30	180



3227-120 / 200



3230 Series

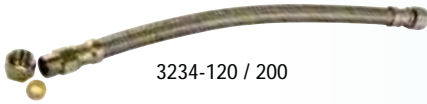

3234-120 / 200



3236 Series



3231 Series



3235 Series



3238-600 / 720



3238-999



3241-480 / 600 / 720



3237-480 / 600 / 720



3237-605 / 725



3228-600 / 120

FLEXIBLE CONNECTORS - BRAIDED STAINLESS STEEL LEAD FREE

- Series 300 stainless steel
- Brass barb insert, ferrules & nuts
- CSA certified
- Meets NSF/ANSI 372 lead free standard

PART NO.	TYPE	LENGTH	INNER	MASTER
3227-120	Faucet - 3/8" Comp. x 3/8" Comp.	12"	25	50
3227-200	Faucet - 3/8" Comp. x 3/8" Comp.	20"	25	50
3230-090	Faucet - 3/8" Comp. x 1/2" FIP	9"	25	50
3230-120	Faucet - 3/8" Comp. x 1/2" FIP	12"	25	50
3230-160	Faucet - 3/8" Comp. x 1/2" FIP	16"	25	50
3230-200	Faucet - 3/8" Comp. x 1/2" FIP	20"	25	50
3230-300	Faucet - 3/8" Comp. x 1/2" FIP	30"	1	25
3230-360	Faucet - 3/8" Comp. x 1/2" FIP	36"	1	25
3234-120	Faucet - 3/8" O.D. Copper x 3/8" O.D. Comp.	12"	25	50
3234-200	Faucet - 3/8" O.D. Copper x 3/8" O.D. Comp.	20"	25	50
3236-120	Faucet - 1/2" FIP x 1/2" FIP	12"	25	50
3236-160	Faucet - 1/2" FIP x 1/2" FIP	16"	25	50
3236-200	Faucet - 1/2" FIP x 1/2" FIP	20"	25	50
3236-300	Faucet - 1/2" FIP x 1/2" FIP	30"	25	50
3231-060	Toilet - 3/8" Comp. x 7/8" Ballcock	6"	25	50
3231-090	Toilet - 3/8" Comp. x 7/8" Ballcock	9"	25	50
3231-120	Toilet - 3/8" Comp. x 7/8" Ballcock	12"	25	50
3231-160	Toilet - 3/8" Comp. x 7/8" Ballcock	16"	25	50
3231-200	Toilet - 3/8" Comp. x 7/8" Ballcock	20"	25	50
3235-480	Dishwasher- 3/8" Comp. x 3/8" MIP	48"	1	25
3235-600	Dishwasher- 3/8" Comp. x 3/8" MIP	60"	1	25
3235-720	Dishwasher- 3/8" Comp. x 3/8" MIP	72"	1	25
3235-960	Dishwasher- 3/8" Comp. x 3/8" MIP	96"	1	25
3238-600	Dishwasher- 3/4" Hose x 3/8" O.D. Comp.	60"	1	25
3238-720	Dishwasher- 3/4" Hose x 3/8" O.D. Comp.	72"	1	25
3238-999	Dishwasher Elbow 3/4" Hose x 3/8" O.D. Comp.		25	200
NEW 3241-480	Dishwasher Kit - 3 Pieces	48"	1	25
NEW 3241-600	Dishwasher Kit - 3 Pieces	60"	1	25
NEW 3241-720	Dishwasher Kit - 3 Pieces	72"	1	25
3237-480	Washing Machine - 3/4" Hose x 3/4" Hose	48"	1	20
3237-600	Washing Machine - 3/4" Hose x 3/4" Hose	60"	1	20
NEW 3237-605	Washing Machine - 3/4" Hose x 3/4" Hose With 90° Elbow	60"	1	20
3237-720	Washing Machine - 3/4" Hose x 3/4" Hose	72"	1	20
NEW 3237-725	Washing Machine - 3/4" Hose x 3/4" Hose With 90° Elbow	72"	1	20
3228-600	Ice Maker - 1/4" Comp. x 1/4" Comp.	60"	1	25
3228-120	Ice Maker - 1/4" Comp. x 1/4" Comp.	120"	1	25

Plumbing Specialties

FLEXIBLE CONNECTORS - BRAIDED STAINLESS STEEL LEAD FREE

- Series 300 stainless steel
- Brass barb insert, ferrules & nuts
- CSA certified
- Meets NSF/ANSI 372 lead free standard



PART NO.	TYPE	LENGTH	INNER	MASTER
NEW 3224-120	Faucet - 1/2" Push-Fit Angle Valve x 1/2" FIP	12"	1	25
NEW 3224-180	Faucet - 1/2" Push-Fit Angle Valve x 1/2" FIP	18"	1	25
NEW 3224-240	Faucet - 1/2" Push-Fit Angle Valve x 1/2" FIP	24"	1	25
NEW 3225-120	Toilet - 1/2" Push-Fit Angle Valve x 7/8" Ballcock	12"	1	25
3229-180	Water heater - 3/4" FIP x 3/4" FIP	18"	25	50
3229-185	Water heater - 3/4" MIP x 3/4" FIP	18"	25	50
NEW 3229-212	Water Heater - 3/4" FIP x 3/4" Push-Fit	12"	10	30
NEW 3229-243	Water Heater - 3/4" FIP x 1/2" Push-Fit	18"	10	30
NEW 3229-244	Water Heater - 3/4" FIP x 3/4" Push-Fit	18"	10	30
NEW 3229-612	Water Heater - 3/4" FIP x 3/4" Push-Fit Valve	12"	10	30
NEW 3229-643	Water Heater - 3/4" FIP x 1/2" Push-Fit Valve	18"	10	30
NEW 3229-644	Water Heater - 3/4" FIP x 3/4" Push-Fit Valve	18"	10	30
3226-033	Repair Hose - 1/2" Push-Fit x 1/2" Push-Fit	12"	10	30
3226-044	Repair Hose - 3/4" Push-Fit x 3/4" Push-Fit	12"	10	30

WATER HEATER CONNECTORS - COPPER - LEAD FREE

- High quality corrugated copper
- Flexible for easier connection
- cUPC certified
- Meets NSF/ANSI 372 lead free standard



PART NO.	INLET	LENGTH	INNER	MASTER
3260-120	3/4" FIP x 3/4" Solder	12"	1	25
3260-150	3/4" FIP x 3/4" Solder	15"	1	25
3260-180	3/4" FIP x 3/4" Solder	18"	1	25
3260-240	3/4" FIP x 3/4" Solder	24"	1	25

SUPPLY FITTINGS - LEAD FREE

- All brass construction, chrome plated
- Angle or Straight 3/8" O.D. compression outlet
- Meets NSF/ANSI 372 lead free standard



PART NO.	TYPE	SIZE	INNER	MASTER
3291-112	Straight	1/2" F.I.P.	50	500
3291-113	Straight	1/2" M.I.P.	50	500
3291-114	Straight	1/2" Solder	50	500
3291-214	Straight	5/8" O.D. Comp.	50	500
3291-118	Angle	1/2" M.I.P.	50	500
3291-119	Angle	1/2" Solder	50	500
3291-219	Angle	5/8" O.D. Comp.	50	500

ESCUTCHEON PLATES

- Chrome plated steel



PART NO.	TYPE	SIZE	INNER	MASTER
3158-102	Iron Pipe Size	3/8"	25	500
3158-103	Iron Pipe Size	1/2"	25	500
3158-104	Iron Pipe Size	3/4"	25	500
3158-602	Copper Tube Size	3/8"	25	500
3158-603	Copper Tube Size	1/2"	25	500
3158-604	Copper Tube Size	3/4"	25	500

FLEX SEAL COUPLINGS

- Flexible PVC construction
- Complete range of sizes and styles for a wide variety of applications
- 300 series stainless steel band assemblies
- cUPC certified



CAST IRON OR PLASTIC TO CAST IRON OR PLASTIC

PART NO.	TYPE	SIZE	MASTER
3625-001	1056-125	1 1/4" x 1 1/4"	120
3625-002	1056-150/125	1 1/2" x 1 1/4"	100
3625-003	1056-150	1 1/2" x 1 1/2"	100
3625-004	1056-215	2" x 1 1/2"	100
3625-005	1056-22	2" x 2"	100
3625-006	1056-315	3" x 1 1/2"	45
3625-007	1056-32	3" x 2"	45
3625-008	1056-33	3" x 3"	45
3625-009	1056-42	4" x 2"	30
3625-010	1056-43	4" x 3"	30
3625-011	1056-44	4" x 4"	30
3625-012	1056-54	5" x 4"	25
3625-013	1056-55	5" x 5"	25
3625-014	1056-64	6" x 4"	32
3625-015	1056-65	6" x 5"	20
3625-016	1056-66	6" x 6"	20
3625-017	1056-84	8" x 4"	10
3625-018	1056-86	8" x 6"	20
3625-019	1056-88	8" x 8"	10

ASBESTOS CEMENT / DUCTILE IRON TO CAST IRON / PLASTIC

PART NO.	TYPE	SIZE	MASTER
3626-011	1051-44	4" x 4"	25
3626-016	1051-66	6" x 6"	20

CLAY TO CLAY

PART NO.	TYPE	SIZE	MASTER
3627-011	1001-44	4" x 4"	16
3627-014	1001-64	6" x 4"	10
3627-016	1001-66	6" x 6"	10

CLAY TO CAST IRON OR PLASTIC

PART NO.	TYPE	SIZE	MASTER
3628-010	1002-43	4" x 3"	60
3628-011	1002-44	4" x 4"	30
3628-014	1002-64	6" x 4"	20
3628-016	1002-66	6" x 6"	20
3628-018	1002-86	8" x 6"	10
3628-019	1002-88	8" x 8"	8
3628-021	1002-1010	10" x 10"	5



FLEX SEAL COUPLINGS

CONCRETE TO CAST IRON OR PLASTIC

PART NO.	TYPE	SIZE	MASTER
3629-011	1006-44	4" x 4"	25
3629-016	1006-66	6" x 6"	20
3629-019	1006-88	8" x 8"	10



TUBULAR DRAIN AND TRAP COUPLINGS

PART NO.	SIZE	MASTER
3630-002	1 1/2" x 1 1/2" or 1 1/4"	60
3630-003	2" x 1 1/2"	50
3630-501	1 1/2" or 1 1/4" Tubular or plastic	60



FLEXIBLE TEES, ELBOWS, AND CAPS

PART NO.	TYPE	SIZE	MASTER
3621-001	Tee	1 1/2"	60
3621-002	Tee	2"	20
3621-003	Tee	3"	20
3621-004	Tee	4"	6
3622-001	Elbow	1 1/2"	100
3622-002	Elbow	2"	20
3622-003	Elbow	3"	20
3623-001	Pipe cap	1 1/2"	160
3623-002	Pipe cap	2"	150
3623-003	Pipe cap	3"	100
3623-004	Pipe cap	4"	80



FLEXIBLE FITTINGS

PART NO.	TYPE	MASTER
3624-001	Flexible downspout connector	100
3624-301	Dishwasher drain connector	80
3624-501	Flexible drain trap	20
3624-701	Washer hose gripper	160



FLEXIBLE P-TRAP

PART NO.	TYPE	SIZE	INNER	MASTER
3624-601		1 1/2" x 1 1/4"	10	40

NEW

MECHANICAL JOINT COUPLINGS

- 300 series stainless steel shield and clamp assembly
- Elastomeric gaskets meet the requirements of ASTM C564
- Meets the requirements of CAN/ULC S102 "surface burning characteristics"
- CSA, cUPC certified



PART NO.	SIZE	MASTER
3208-901	1 1/2"	100
3208-902	2"	100
3208-903	3"	100
3208-904	4"	100
3208-906	6"	30
3208-921	2" x 1 1/2"	100

NEW

SHIELDED TRANSITION COUPLINGS

- 300 series stainless steel shield and clamp assembly
- Elastomeric gaskets meet the requirements of ASTM C564
- cUPC certified



PART NO.	TYPE	SIZE	MASTER
3208-502	Cast Iron, Plastic, Steel to Copper - DWV	1 1/2" to 1 1/4"	100
3208-503	Cast Iron, Plastic, Steel to Copper - DWV	1 1/2" to 1 1/2"	100
3208-504	Cast Iron, Plastic, Steel to Copper - DWV	2" to 1 1/2"	100
3208-505	Cast Iron, Plastic, Steel to Copper - DWV	2" to 2"	100
3208-507	Cast Iron, Plastic, Steel to Copper - DWV	3" to 2"	100
3208-508	Cast Iron, Plastic, Steel to Copper - DWV	3" to 3"	100
3208-510	Cast Iron, Plastic, Steel to Copper - DWV	4" to 3"	100
3208-511	Cast Iron, Plastic, Steel to Copper - DWV	4" to 4"	100
3208-603	Copper to Copper - DWV	1 1/2" to 1 1/2"	100
3208-604	Copper to Copper - DWV	2" to 1 1/2"	100
3208-605	Copper to Copper - DWV	2" to 2"	100

NEW

TORQUE WRENCHES

- 5/16" ratchet torque wrench
- Built-in reversing lever
- Preset to 60 in. lbs. torque
- Chrome plated shank, all metal construction



PART NO.	MASTER
3619-001	120

TEST PLUGS

- Rubber gaskets
- Engineered and designed for maximum gripping power in all types of pipe
- Large wing nuts for easy operation



PART NO.	SIZE	INNER	MASTER
3154-007	1 1/2"	6	36
3154-008	2"	6	36
3154-010	3"	6	36
3154-011	4"	6	36
3154-012	5"	1	20
3154-013	6"	1	20

DRAIN COVERS

- Type 304 stainless steel

- Easy adjustable legs allow fitting to most pipes



PART NO.	SIZE	INNER	MASTER
3485-007	3" Cover for 1 1/2" Pipe	10	80
3485-008	3" Cover for 2" Pipe	10	80
3485-010	4" Cover for 3" Pipe	10	40
3485-011	5" Cover for 4" Pipe	10	40

SEWER STOPS

- Automatic backflow preventer

- Easy installation, stops flooding



PART NO.	TYPE	SIZE	INNER	MASTER
3490-010	Steel Flanges	3"	1	50
3490-011	Steel Flanges	4"	1	50
3490-508	Brass Flanges	2"	1	50
3490-510	Brass Flanges	3"	1	50
3490-511	Brass Flanges	4"	1	50

PVC DRAIN RINGS AND COVERS



PART NO.	TYPE	SIZE	INNER	MASTER
3492-016	Drain ring with cover	6"	1	30
3492-116	Drain ring only	6"	1	30
3492-216	Solid cover only	6"	1	90
3492-316	Slotted cover only	6"	1	90
3492-118	Drain ring only	8"	1	30
3492-218	Solid cover only	8"	1	60
3492-318	Slotted cover only	8"	1	60

TRANSITION COUPLINGS - ABS TO COPPER



PART NO.	TYPE	SIZE	INNER	MASTER
3493-007	ABS to copper DWV	1 1/2"	1	200
3493-008	ABS to copper DWV	2"	1	100
3493-010	ABS to copper DWV	3"	1	30

SUMP PUMP & SEWAGE PUMP CHECK VALVES

- Each valve shipped complete with two flexible couplings and four corrosion resistant clamps
- Flexible couplings can be reversed to fit 1 1/4" or 1 1/2" drain pipe

- For schedule 40 plastic, DWV, black or galvanized pipe
- Eliminates backflow and wear on pump



PART NO.	TYPE	SIZE	INNER	MASTER
3240-150	Sump Pump Check Valve	1 1/4" - 1 1/2"	1	48
3240-200	Sewage Pump Check Valve	2"	1	24



KITCHEN SINK STRAINERS - TURN & SEAL

- Heavy gauge stainless steel construction
- Metal locknuts
- Made in Canada
- Stainless steel threads
- Three prong basket seal

PART NO.	TYPE	SIZE	INNER	MASTER
3209-801	With brass tailpiece	4 1/2"	1	40



KITCHEN SINK STRAINERS - FLEX STEM

- Heavy gauge stainless steel construction
- Metal locknuts
- Made in Canada
- Stainless steel threads
- Flex stem basket seal

PART NO.	TYPE	SIZE	INNER	MASTER
3209-901	With brass tailpiece	4 1/2"	1	40



REPLACEMENT BASKETS

PART NO.	TYPE	SIZE	INNER	MASTER
3209-301	Flex Stem	3 1/2"	1	250
3209-302	Gravity Stem	3 1/2"	1	250
3209-303	Galt Style	3 1/2"	1	250
3209-304	Turn & seal	3 1/2"	1	250



SINK TAILPIECES - BRASS

PART NO.	TYPE	SIZE	INNER	MASTER
3209-258	Tubular brass, with flange	1 1/2" x 25 8"	1	200
3209-404	Tubular brass, with flange	1 1/2" x 4"	1	150
3209-406	Tubular brass, with flange	1 1/2" x 6"	1	100



KITCHEN SINK STRAINERS - STAINLESS STEEL

- Rolled edge crumb cup
- Fits sinks with 3 1/2" to 4" openings

PART NO.	SIZE	INNER	MASTER
3131-201	4 1/2"	1	50



KITCHEN SINK STRAINERS - CHROME PLATED BRASS

- Deep well design
- Fits sinks with 3 1/2" to 4" opening
- Rolled edge crumb cup

PART NO.	SIZE	INNER	MASTER
3131-301	4 1/2"	1	24



BAR SINK STRAINERS - STAINLESS STEEL

- Rolled edge crumb cup
- Fits sinks with 1 7/8" to 2 1/4" opening

PART NO.	SIZE	INNER	MASTER
3131-202	2 1/2"	1	80



DUPLEX STRAINERS - STAINLESS STEEL

- Stainless steel grid
- Fits all sinks with 1 7/8" to 2 1/4" opening

PART NO.	SIZE	INNER	MASTER
3133-202	2 1/2"	1	80



LAUNDRY TUB STRAINERS - STAINLESS STEEL

- White rubber stopper
- Fits all sinks with 1 7/8" to 2 1/4" opening

PART NO.	SIZE	INNER	MASTER
3132-201	2 1/2"	1	80



SHOWER DRAINS - SOLVENT WELD - TWO PIECE

- For fiberglass, acrylic, or plastic shower stall
- Two piece ABS body allows installation to be completed after shower base has been fitted
- Solvent welds to 2" or 1 1/2" ABS DWV pipe
- Offset drain allows for a 1 1/2" margin of error

PART NO.	TYPE	SIZE	INNER	MASTER
3133-113	Stainless steel grid	2"	20	80
NEW 3133-114	Brushed nickel grid	2"	20	80
NEW 3133-117	Stainless steel grid, offset body	2"	20	80



SHOWER DRAINS WITH CLAMP

- For use in built up shower construction
- ABS waterproofing clamp, stainless steel screws
- 2" solvent weld ABS body
- Adjustable strainer with 4" stainless steel grid

PART NO.	TYPE	SIZE	INNER	MASTER
3398-100	Round Stainless Steel Grid	2"	12	48
NEW 3398-104	Round Brushed Nickel Grid	2"	12	48
3398-500	Square Stainless Steel Grid / Large body	2"	12	36
NEW 3398-504	Square Brushed Nickel Grid / Large body	2"	12	36



Brass Body



PVC Body

SHOWER DRAINS - QUICK CAULKING

- 2" Schedule 40 steel or plastic pipe
- No solvent or lead required
- Internal compression sealing gasket
- Use on steel, fiberglass and plastic shower bases

PART NO.	TYPE	SIZE	INNER	MASTER
3133-101	PVC body, white grid	2"	1	40
3133-102	PVC body, stainless steel grid	2"	1	40
3133-103	PVC body, PVD polished brass grid	2"	1	40
3133-301	Brass body, stainless steel grid	2"	1	40

SHOWER DRAINS - SOLVENT WELD - ONE PIECE

- Use on steel, fiberglass and plastic shower base
- Solvent welds to 2" DWV Schedule 40 ABS pipe



PART NO.	TYPE	SIZE	INNER	MASTER
3133-105	ABS body, white grid	2"	1	40
3133-107	ABS body, stainless steel grid	2"	1	40

SHOWER STALL STRAINERS

- Chrome plated
- Stainless steel grid, 3 1/2" flange diameter



PART NO.	SIZE	INNER	MASTER
3133-404	2"	1	80
3133-405	1 1/2"	1	80

SHOWER DRAIN GRIDS



PART NO.	TYPE	SIZE	INNER	MASTER
3133-901	Stainless Steel	4 1/2"	1	200
3133-902	Polished Brass	4 1/2"	1	200
3133-903	Antique Brass	4 1/2"	1	200
3133-904	White plastic	4 1/2"	1	200

GENERAL PURPOSE DRAINS

- Use in concrete, terrazzo, and ceramic tile
- Stainless steel grid
- Fits 2" and 3" or 3" and 4" Schedule 40 pipe
- Ideal for showers, floors, decks, and patios



PART NO.	TYPE	SIZE	INNER	MASTER
3133-110	ABS	2" - 3"	1	20
3133-111	ABS	3" - 4"	1	10

UTILITY DRAINS / CLEANOUTS

- Commercial grade
- ABS body with ductile iron grid or cover plate



PART NO.	TYPE	SIZE	INNER	MASTER
3495-010	Utility drain with grid	3"	6	36
3495-011	Utility drain with grid	4"	6	36
3496-010	Utility cleanout with plate	3"	6	36
3496-011	Utility cleanout with plate	4"	6	36

Plumbing Specialties

SHOWER DRAINS WITH CLAMP - CAST IRON

- For use in built up shower construction
- Waterproofing clamp, stainless steel screws
- 2" threaded cast iron body
- Adjustable strainer with 4" stainless steel grid



PART NO.	TYPE	SIZE	INNER	MASTER
3497-007	Cast iron, stainless steel grid	1 1/2"	1	24
3497-008	Cast iron, stainless steel grid	2"	1	24



ACCESS PANELS

- Fast and efficient installation
- No framing or tools required
- Paintable
- Made in Canada

PART NO.	TYPE	SIZE	MASTER
3156-708	Plastic	8" x 8"	10
3156-712	Plastic	12" x 12"	10

NEW

TUB & SHOWER FAUCET TRIM KITS

- Kit includes push on tub spouts, regular or deluxe shower head, chrome plated brass shower arms and chrome plated steel flanges
- Polished chrome finish



PART NO.	TYPE	INNER	MASTER
3140-001	Standard shower head	1	30
3140-002	Deluxe shower head	1	30



3142-090

3142-091

3142-092



3142-093

3142-094

3142-095



3142-096

3142-103

TUB SPOUTS

- Type "A" units have a face bushing for 1/2" or 3/4" connection at the rear of the spout
- Type "B" units have a 1/2" IPS connection at the front of the spout
- Type "C" units are made push on over 1/2" (5/8" O.D.) copper tubing
- All spouts feature mirror polished finishes

PART NO.	TYPE	INNER	MASTER
3142-090	"A" Brass Diverter - Chrome	1	48
3142-091	"A" Brass Diverter with 1/2" Side Connection - Chrome	1	48
3142-092	"B" Die Cast Tub Spout - Chrome	1	48
3142-093	"A" Die Cast Diverter - Chrome	1	48
3142-094	"A" Die Cast Diverter (1/2" Side Connection Chrome)	1	48
3142-095	"B" Die Cast Diverter - Chrome	1	48
3142-096	"C" Die Cast Diverter - Push On - Chrome	1	48
3142-103	"C" Die Cast Tub Spout - Push On - Chrome	1	48

WATER SAVING SHOWER HEADS - AERATING

- Chrome plated
- Mixes air and water for an invigorating shower
- 2.5 GPM at 80 PSI



PART NO.	TYPE	INNER	MASTER
3141-304	Standard	1	160
3141-305	With Shut Off	1	120



SHOWER HEADS - ADJUSTABLE

PART NO.	TYPE	SIZE	INNER	MASTER
3141-912	Adjustable	2"	1	100

MECHANICAL POP-UP DRAINS - BRASS

- Chrome plated brass three piece body
- CSA certified

PART NO.	TYPE	SIZE	INNER	MASTER
3215-101	Brass	1 1/4" x 8"	1	24

MECHANICAL POP-UP DRAINS - HYBRID

- Chrome plated brass body
- Plastic tailpiece
- CSA certified

PART NO.	TYPE	SIZE	INNER	MASTER
3215-909	Hybrid	1 1/4" x 8"	1	50

MECHANICAL POP-UP DRAINS - PLASTIC

- Plastic body
- Stainless steel clad stopper and flange
- CSA certified

PART NO.	TYPE	SIZE	INNER	MASTER
3127-106	Plastic	1 1/4" x 8"	1	50

P.O. PLUGS - BRASS - OPEN GRID

- Chrome grid
- Chrome plated brass body
- With overflow holes
- CSA certified



PART NO.	TYPE	SIZE	INNER	MASTER
3206-901	Brass	1 1/4" x 8"	1	50

P.O. PLUGS - BRASS

- Heavy duty three piece cast brass body
- Rubber stopper and brass bead chain
- Chrome plated

PART NO.	TYPE	SIZE	INNER	MASTER
3206-201	Brass - CSA certified	1 1/4" x 6"	1	50
3205-101	Brass	1 1/4" x 6"	1	50

P.O. PLUGS - ABS

- Two piece ABS body, with stainless steel trim ring
- White rubber stopper with chain
- CSA certified

PART NO.	TYPE	SIZE	INNER	MASTER
3206-501	Chrome plated body	1 1/4" x 8"	1	50
3206-601	Black body	1 1/4" x 8"	1	50

P.O. PLUGS - PLASTIC

- Plastic body with stainless steel trim ring, white rubber stopper with chain.
- Individually packaged

PART NO.	TYPE	SIZE	INNER	MASTER
3134-101	No Overflow Holes	1 1/4" x 5"	1	80



CLOSET FLOOR FLANGES - BRASS

PART NO.	TYPE	SIZE	INNER	MASTER
3386-080	Light pattern	4"	10	50
3386-140	Heavy pattern	4"	10	50
3386-500	DWV Brass	4" x 3"	1	50



CLOSET FLOOR FLANGES - PLASTIC

PART NO.	TYPE	SIZE	INNER	MASTER
3152-005	ABS - flush fit	4" x 3"	1	12
3494-001	ABS - Inside fit	3"	1	20



CLOSET BOLTS - BRASS

- Solid brass bolts, nuts, and washers

- Packed in pairs, bagged with label

PART NO.	SIZE	INNER	MASTER
3387-100	5/16" x 2 1/4"	1	250
3387-500	5/16" x 3"	1	250



CLOSET BOLTS - NYLON

- Made from glass-filled nylon
- Corrosion proof

- Packed in pairs in a printed bag

PART NO.	SIZE	INNER	MASTER
3380-100	5/16" x 2 1/2"	50	500

NEW



CLOSET FLANGE EXTENSION KITS

- PVC construction
- 3 1/2" closet bolts & fastening screws included

- Raises flange 1/4", 1/2" or 3/4"
- Extends existing flange up to new floor level

PART NO.	TYPE	MASTER
3274-100	For all types of floor flanges	12



WOBBLY TOILET REPAIR KITS

- Heavy gauge plated steel construction
- Repairs wobbly toilets and loose closet flanges without replacing floors

- Complete with mounting screws & instructions

PART NO.	TYPE	INNER	MASTER
3272-100	For plastic or brass flanges	1	12



SPANNER FLANGES

- Repairs broken toilet flanges

- For all cast iron, brass and plastic toilet flanges

PART NO.	TYPE	INNER	MASTER
3624-901		1	120

NEW

NEW



TOILET TANK FILL VALVES

- Compact one piece design, no float ball & rod
- Built-in filter screen
- Anti-siphon
- Fits all toilet tanks
- Fully adjustable water level
- Improved water inflow control

PART NO.	TYPE	MASTER
3265-700	Plastic - anti-siphon	50



PLASTIC BALLCOCKS

- Complete with 8" solid brass rod, 9" refill tube & holder, coupling & flange nuts, and washers
- Piston valve type

PART NO.	TYPE	SIZE	MASTER
3265-100	Plastic - standard	8 1/2"	30



CLOSET BOWL GASKETS

PART NO.	SIZE	MASTER
3273-100	1/2"	170
3273-200	3/4"	152
3273-300	1"	72



TANK TO BOWL GASKETS

PART NO.	TYPE	MASTER
3547-001	Standard Size - black	25
3547-002	Double Thick - black	12
3547-003	Crane - red	25



TANK BOLT KITS - BRASS

- Each kit contains two 5/16" x 3" solid brass tank bolts, four rubber cloth impregnated washers, four brass washers and four brass hexnuts
- Kits are individually bagged

PART NO.	SIZE	MASTER
3546-001	5/16" x 3"	250



TOILET TANK FLOATS

PART NO.	TYPE	MASTER
3558-001	Black Plastic	36
3558-002	Copper	72



PLUNGERS

- High quality force cups
- Complete with wood handles

PART NO.	TYPE	SIZE	INNER	MASTER
3620-001	Red - For Basin - 9" Handle	4"	1	24
3620-002	Red - 21" Handle	5 1/2"	1	24
3620-003	Black - With Funnel 21" Handle	6"	1	12
3620-005	Black "Beehive" with Funnel 21" handle	6"	1	12



BATH WASTE & OVERFLOWS - EXTERNAL CABLE - BRASS

- Brass construction
- Solid brass trim available in several finishes
- Telescopic adjustment with flexible copper overflow tube
- External cable control
- Brass tailpiece
- CSA certified

PART NO.	TYPE	SIZE	INNER	MASTER
3200-101	Chrome Plated	20"	1	20
3200-201	Polished Brass	20"	1	20
3200-901	Brushed Nickel	20"	1	20
3217-101	Chrome Plated	16"	1	20
3218-101	Chrome Plated	27"	1	10
3218-901	Brushed Nickel	27"	1	10



BATH WASTE & OVERFLOWS - BRASS

- Heavy all brass construction
- Heavy chrome plated brass trim
- Extra long tee for maximum adjustability

PART NO.	TYPE	SIZE	INNER	MASTER
3219-101	Plug & Chain	16"	1	12
3219-301	Trip Lever	16"	1	12



BATH WASTE & OVERFLOWS - PLASTIC

PART NO.	TYPE	SIZE	INNER	MASTER
3129-003	Trip lever	16"	1	12



BATH WASTE & OVERFLOW TRIM KITS

- Kit includes face plate with 1 and 2 hole mounting screws, 1/4" drain and threaded 1/4" x 1 1/2" adapter bushing for drain body
- Fits most 1/4" & 1/2" thread bath wastes

PART NO.	TYPE	INNER	MASTER
3129-501	Chrome, lift lock	4	12



TEFLON TAPE

- Pipe thread tape made of virgin Teflon®
- Provides a strong tight seal for any threaded joints and permits easy disassembly
- Yellow gas seal tape is UL listed

PART NO.	TYPE	SIZE	INNER	MASTER
3213-103	White, 0.35 g/cm ³ density	1/2" x 480" x 0.003"	100	500
3213-480	White, 0.50 g/cm ³ density	1/2" x 480" x 0.003"	100	500
3203-480	Yellow, 1.2 g/cm ³ density	1/2" x 480" x 0.094"	100	500
3204-260	Pink, 1.2 g/cm ³ density	1/2" x 260" x 0.094"	100	500

ROOF FLASHINGS

- Heavy duty, extra thick EPDM construction
- For copper, plastic or cast iron pipe
- Full 20" x 20" apron, double seal collar
- Accommodates 2-12 through 6-12 pitch roofs



PART NO.	TYPE	SIZE	MASTER
3388-001	Flexible EPDM	1 1/2"	18
3388-002	Flexible EPDM	2"	18
3388-003	Flexible EPDM	3"	18
3388-004	Flexible EPDM	4"	18

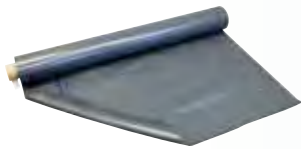

SHOWER PAN LINER - ROLLS

- Flexible polyvinylchloride (PVC) grey sheet
- 30 ml thick, continuously marked on the roll

PART NO.	TYPE	MASTER
3397-400	4 ft wide x 50 ft long	1
3397-500	5 ft wide x 40 ft long	1



SUSPENSION STRAP - COILS

- Perforated to accept nails or bolts, 3/4" wide
- Available in variety of finishes & lengths, boxed

PART NO.	TYPE	SIZE	INNER	MASTER
3611-010	Steel	10 FT	1	34
3611-025	Steel	25 FT	1	20
3611-100	Steel	100 FT	1	5
3613-010	Galvanized Steel	10 FT	1	34
3613-025	Galvanized Steel	25 FT	1	20
3613-100	Galvanized Steel	100 FT	1	5
3615-010	Solid Copper	10 FT	1	34
3615-025	Solid Copper	25 FT	1	20
3617-010	Copper Clad	10 FT	1	34
3617-025	Copper Clad	25 FT	1	20
3617-100	Copper Clad	100 FT	1	5



TWO HOLE TUBE STRAPS

- Solid copper or copper clad, Made in Canada
- Shipped in polybags with 2 nails per strap

PART NO.	TYPE	SIZE	INNER	MASTER
3214-103	Solid Copper	1/2"	100	1000
3214-104	Solid Copper	3/4"	100	500
3214-203	Copper Clad	1/2"	100	1000
3214-204	Copper Clad	3/4"	100	500



JUST FOR COPPER GLUE

- Solderless copper bonding
- Non-flammable, non-toxic, odorless and tasteless
- Tested to 1000 PSI, rated to 500 PSI
- Temperature range of -40°C to 120°C

PART NO.	TYPE	SIZE	MASTER
3576-010	Standard	10 gram	12
3576-050	Standard	50 gram	12
3576-950	PRO version	50 gram	12



TEST PLUGS FOR TUB & SHOWER VALVES

- For temporary closure of threaded fittings after tub & shower faucet rough-in
- Self sealing
- Will not mark or chip bathtubs or showers

PART NO.	TYPE	SIZE	INNER	MASTER
3222-003	Test plug for tub & shower valves	1/2" x 5"	10	100

DIELECTRIC UNIONS

- Prevents electrolysis or galvanic action when connecting dissimilar materials
- Threaded ends comply with ANSI B1.20.1
- For use with water up to 210°F
- Solder ends comply with ANSI B16.18



PART NO.	TYPE	SIZE	INNER	MASTER
3168-003	Female x Solder	1/2"	10	100
3168-004	Female x Solder	3/4"	10	100
3168-005	Female x Solder	1"	10	80
3168-006	Female x Solder	1 1/4"	10	40
3168-007	Female x Solder	1 1/2"	5	30
3168-008	Female x Solder	2"	5	20
3168-094	Female x Solder	3/4" x 1/2"	10	100
3167-004	Male x Solder	3/4"	25	100
3167-094	Male x Solder	3/4" x 1/2"	25	100

FLEXIBLE GAS CONNECTORS - STAINLESS STEEL

- 7/8" O.D. corrugated stainless steel tubing
- Complete with plated steel end fittings
- Safely connects appliances to gas supply
- Design certified for indoor and outdoor use, complies with CSA 6.10, CSA 6.27, CSA B149.1



PART NO.	TYPE	SIZE	MASTER
3280-018	18"	3/4" F.I.P.	25
3280-024	24"	3/4" F.I.P.	25
3280-036	36"	3/4" F.I.P.	25
3280-048	48"	3/4" F.I.P.	25
3280-112	12"	1/2" M.I.P.	25
3280-118	18"	1/2" F.I.P.	25
3280-124	24"	1/2" F.I.P.	25
3280-136	36"	1/2" F.I.P.	25
3280-148	48"	1/2" F.I.P.	25
3282-001	End fitting only	1/2" F.I.P.	25
3282-002	End fitting only	3/4" F.I.P.	25
3282-003	End fitting only	1/2" M.I.P.	25
3282-004	End fitting only	3/4" M.I.P.	25

EZ CONNECT ADAPTERS - LEAD FREE

- Brass construction, use on hot or cold water
- Swivel screw connection, no drilling or extra valves required
- Creates a branch outlet from any supply stop
- Use when installing an ice maker, dishwasher, under-the-counter water filter or any other appliance that uses 1/4" or 3/8" O.D. copper or plastic tubing
- Meets NSF/ANSI 372 lead free standard



PART NO.	SIZE	INNER	MASTER
3993-915	3/8" x 1/4"	10	80
3993-916	3/8" x 3/8"	10	80

ICE MAKER / HUMIDIFIER INSTALLATION KITS

- Self piercing saddle valve
- Allows complete connection from water line to appliance
- 25' of tubing



PART NO.	MASTER
3993-001	25

SADDLE VALVES - LEAD FREE

- Brass construction
- Outlet fits 1/4" copper or poly tubing
- For use on copper tubing from 3/8" to 1"
- Meets NSF/ANSI 372 lead free standard



PART NO.	TYPE	INNER	MASTER
3993-904	Self Piercing	25	200

TRAP CONNECTORS

• Brass slip ring

• Chrome plated die cast nut



PART NO.	TYPE	SIZE	INNER	MASTER
3158-866	Slip x Male †	1/4" x 1/4"	12	72
3158-876	Slip x Male †	1/4" x 1/2"	12	72
3158-877	Slip x Male †	1/2" x 1/2"	12	72
† Male end I.D. machined for copper sweat installation				
3158-966	Slip x Female	1/4" x 1/4"	12	72
3158-976	Slip x Female	1/4" x 1/2"	12	72
3158-977	Slip x Female	1/2" x 1/2"	12	72

FLOOR AND CEILING PLATES

• Chrome plated heavy steel split flange



PART NO.	TYPE	SIZE	INNER	MASTER
3158-003	Iron Pipe Size	1/2"	12	288
3158-004	Iron Pipe Size	3/4"	12	288
3158-005	Iron Pipe Size	1"	12	288
3158-006	Iron Pipe Size	1 1/4"	12	288
3158-007	Iron Pipe Size	1 1/2"	12	288
3158-008	Iron Pipe Size	2"	12	144
3158-503	Copper Tube Size	1/2"	12	288
3158-504	Copper Tube Size	3/4"	12	288
3158-505	Copper Tube Size	1"	12	288
3158-506	Copper Tube Size	1 1/4"	12	288
3158-507	Copper Tube Size	1 1/2"	12	288

PVC UNIONS

- For both Schedule 40 & Schedule 80 pipe
- Threaded ends comply with ANSI B1.20.1
- Solvent ends comply with ASTM D2466

- NSF certified
- Meets NSF/ANSI 372 lead free standard
- Rated at 150 PSI at 73°F



PART NO.	TYPE	SIZE	INNER	MASTER
3164-103	Threaded	1/2"	12	96
3164-104	Threaded	3/4"	12	72
3164-105	Threaded	1"	12	60
3164-106	Threaded	1 1/4"	6	36
3164-107	Threaded	1 1/2"	6	36
3164-108	Threaded	2"	6	24
3164-603	Solvent	1/2"	12	96
3164-604	Solvent	3/4"	12	72
3164-605	Solvent	1"	12	60
3164-606	Solvent	1 1/4"	6	36
3164-607	Solvent	1 1/2"	6	36
3164-608	Solvent	2"	6	24



WATER HEATER EARTHQUAKE RESTRAINTS

- "Quick Strap" is the most tested and recognized water heater restraint
- Galvanized steel strap, with hardware
- Supports up to 80 gallon water heaters

PART NO.	TYPE	INNER	MASTER
3221-050	QS-50 water heater restraint	1	15



SHOWER STALL ELBOWS

- Brass body
- For stable mounting of shower arm to shower stalls

PART NO.	TYPE	SIZE	INNER	MASTER
3993-113	MIP	1/2"	6	72
NEW 3993-913	PEX	1/2"	6	72



MOUNTING PLATES

- For all frost free wall hydrants and sillcocks

PART NO.	INNER	MASTER
3993-117	1	15



TRAPVENTS

- Replaces any secondary plumbing vent protecting the traps of kitchen sinks, bathroom basins, tubs, showers or Laveuses

PART NO.	TYPE	SIZE	INNER	MASTER
3995-001	Threaded	1 1/2"	1	90



SHOWER ROD FLANGES

- Chrome plated, adjustable
- Rubber pads where flange contacts wall

PART NO.	TYPE	INNER	MASTER
3993-013	Die cast zinc	50	100



WASHING MACHINE HOSES

- High pressure hose
- Burst strength 800 psi
- For hot and cold water
- Bulk pack or individually bagged with washers

PART NO.	TYPE	LENGTH	MASTER
3250-004	Female x female, bagged	4 ft.	10
3250-005	Female x female, bulk	5 ft.	50
3250-905	Female x female, bagged	5 ft.	10
3250-006	Female x female, bulk	6 ft.	50
3250-906	Female x female, bagged	6 ft.	10
3250-908	Female x female, bagged	8 ft.	10
3250-010	Female x female, bagged	10 ft.	10
3250-012	Female x female, bagged	12 ft.	10
3250-015	Female x female, bagged	15 ft.	10
3250-195	Female x female 90° elbow, bagged	5 ft.	10
3250-196	Female x female 90° elbow, bagged	6 ft.	10
3250-198	Female x female 90° elbow, bagged	8 ft.	10
3250-305	Dishwasher inlet hose Fem. 90° elbow x 1/8" male	5 in.	10
3250-412	"Y" Mixer hose, bulk	12 in.	50
3250-912	"Y" Mixer hose, bagged	12 in.	10

HIGH PRESSURE DRAIN HOSE - DISPENSER CARTONS

- Smooth black finish, EPDM compound
- Polyester reinforced for maximum service life for all domestic & commercial pressure applications



PART NO.	TYPE	LENGTH	MASTER
3251-001	5/8" I.D.	50 ft.	1
3251-002	7/8" I.D.	50 ft.	1

NON PRESSURE DRAIN HOSE

- Smooth black finish, EPDM compound

PART NO.	TYPE	LENGTH	MASTER
3251-101	1 5/16" I.D.	50 ft.	1

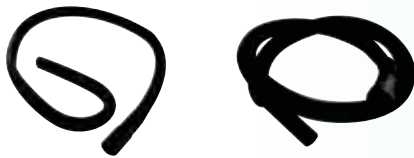

PREFORMED DRAIN HOSE

PART NO.	TYPE	SIZE	INNER	MASTER
3251-305	Hook hose - rubber	5 ft.	1	10
3251-606	Corrugated plastic	6 ft.	1	5

TOUCH-UP PAINT - BRUSH TOP BOTTLES

- Ideal for sinks, bathtubs and appliances
- Computer matched for colour accuracy
- Manufactured in Canada
- Available in American Standard, Crane colours
- Skin packed in 15 ml brush-top bottles



PART NO.	COLOUR	INNER	MASTER
American Standard			
3475-001	American Standard White	1	6
3475-002	Bone	1	6
3475-003	Silver Grey	1	6
3475-004	Fawn Beige	1	6
Appliances			
3477-001	White	1	6
Crane			
3476-001	White	1	6
3476-002	Antique White	1	6
3476-003	Platinum Grey	1	6



INSTALLATION KITS FOR TOILETS

NEW

- Includes wax gasket with flange, set of solid brass closet bolts, nuts and washers, 12" braided stainless steel connector
- Display pack with header card and installation instructions included
- For all toilets

PART NO.	TYPE	INNER	MASTER
3270-001	Universal	1	24



INSTALLATION KITS FOR FAUCETS

NEW

- Each kit includes two push-fit supply valves - two angle or two straight
- Includes two extra long 20" braided stainless steel faucet connectors
- Push-fit removal tool also included in kit
- Includes two chrome plated stainless steel escutcheon plates
- Push fit supply valves connect to copper, CPVC & PEX tubing
- Universal design, for all types of faucets

PART NO.	TYPE	INNER	MASTER
3270-002	Angle valves	5	20
3270-102	Straight valves	5	20



INSTALLATION KITS FOR DISHWASHERS

NEW

- Each kit includes ABS dishwasher "Y" with 1/2" branch, removal tool, and teflon tape
- Includes 60" or 72" braided stainless supply line with two elbows - 3/8" MIP and 3/4" female hose
- Includes push-fit supply valve
- Display pack with header card and installation instructions included
- Push fit supply valve connects to copper, CPVC & PEX tubing
- Universal design, for all types of dishwashers

PART NO.	TYPE	INNER	MASTER
3270-600	Universal - 60" Supply Line	5	20
3270-720	Universal - 72" Supply Line	5	20
3994-001	Dishwasher Y Only - 1/2" x 1/2" x 1/2"	5	20



WAX GASKETS - WITH FLANGE

PART NO.	DESCRIPTION	MASTER
7500-001	Standard wax, fits 3" & 4" lines, for floor closet bowls only	24
7500-003	Urethane wax, fits 3" & 4" lines, for floor closet bowls only	24
7500-010	Standard wax, extra thick 40% more wax for more positive seal	24



WAX GASKETS - LESS FLANGE

PART NO.	DESCRIPTION	MASTER
7501-000	Economy 6 ounce for floor closet bowls	48
7501-001	Standard 8 ounce, for floor closet bowls	48
7501-005	Urethane wax, fits 3" & 4" lines, wall or floor bowls	24
7501-006	Urethane wax, fits 2" urinal outlet	24



PLUMBER'S PUTTY

- Stainless, long lasting and easy to use
- Remains flexible, will not harden, shrink, crack or crumble even if can is left open
- For setting bowls, rims, strainers, faucets, etc.
- Not for use on marble or plastic

PART NO.	TYPE	SIZE	MASTER
7515-001	Plastic Can	397 g	24



TFE PASTE

- Thread lubricant and sealant
- Pure white. Non-hardening
- Apply to clean male pipe threads on metals, PVC, CPVC, ABS, polypropylene and nylon

PART NO.	TYPE	SIZE	MASTER
7507-001	Hang-Tab Tube	30 ml	48
7507-003	Brushtop Bottle	118 ml	12
7507-004	Brushtop Bottle	236 ml	12
7507-005	Brushtop Bottle	473 ml	12



PIPE THREAD COMPOUND

- Thixotropic non-drip paste for pipe joint threads
- Never hardens, joints separate easily
- Prevents corrosion to threads
- Does not contain lead

PART NO.	TYPE	SIZE	MASTER
7509-001	Hang-Tab Tube	30 ml	144
7509-003	Brushtop Bottle	230 ml	12



PIPE THREAD STICK

- Pipe thread compound in stick form
- Lubricates, seals and prevents rust & corrosion

PART NO.	TYPE	SIZE	INNER	MASTER
7510-001	12 Sticks/Display	37 g	12	48

Plumbing Specialties

FAUCET & VALVE GREASE

- Resists high temperature, waterproof
- Apply to stems of faucets, valves, ball cocks, plungers, packings and washers



PART NO.	TYPE	SIZE	MASTER
7519-001	Hang tab tube	30 ml	48

EPOXY PUTTY

- Hardens like steel in 20 minutes
- Stops leaks, makes repairs fast!
- Can be used on leaky pipes or underwater.



PART NO.	TYPE	SIZE	MASTER
7516-001	Blister card	39 ml	12
7516-002	Tube 12/display	118 ml	12
7516-003	Display refill	59 ml	12
7516-503	18 Tubes in display pack	59 ml	18

FURNACE CEMENT

- For all coal or wood burning furnaces & stoves, withstands same temperatures as fire brick
- Repairs casting cracks - fills voids in and around furnace and stove parts
- Compound resists high temperature and dries to a hard grey finish



PART NO.	TYPE	SIZE	MASTER
7517-001	Can	237 ml	12
7517-002	Can	473 ml	6
7517-003	Can	946 ml	6
7517-501	Cartridge	305 ml	12

SILICONE RUBBER SEALANT

- 100% silicone rubber bathtub caulk
- Resists mildew, waterproof seal, made in Canada



PART NO.	TYPE	SIZE	MASTER
3513-001	Clear	305 ml Cartridge	12
3513-002	White	305 ml Cartridge	12
3514-001	Clear	90 ml Tube	12
3514-002	White	90 ml Tube	12

ACRYLIC TUB SEAL

- For sealing plumbing fixtures, showers and tile.
- Paintable with latex paint
- Siliconized acrylic latex tub & tile caulk in bone or white
- Siliconized to provide better adhesion, resistance to moisture and greater strength



PART NO.	TYPE	SIZE	MASTER
7512-001	Tube - White	163 ml	12

SOLDERING PASTE - LEAD FREE

- Safe for potable water supplies when used for lead free solder



PART NO.	TYPE	SIZE	MASTER
7521-001	Can	50 ml	48
7521-002	Plastic can	118 ml	24
7521-003	Plastic can	236 ml	24
7521-004	Plastic can	473 ml	12

NEW



AMCO C-FLUX

- For soldering copper tube and fittings
- Provides excellent results while ensuring a full fill of solder during the soldering process
- Does not require sanding

PART NO.	SIZE	MASTER
3311-008	75 g	24
3311-009	340 g	24



PLUMBER'S SANDCLOTH

PART NO.	SIZE	MASTER
3566-004 Aluminum oxide, 120 grit	1 1/2" x 5 yard	100
3568-001 Open mesh, 180 grit	1 1/2" x 5 yard	100



FITTING, TUBE & ACID BRUSHES

PART NO.	TYPE	SIZE	INNER	MASTER
3561-003	Fitting brush	1/2"	100	400
3561-004	Fitting brush	3/4"	100	300
3216-101	1" Economy Brush - Wood Handle	1"	1	36
3216-201	Acid Brush - Metal handle	1/4"	144	1728
3216-301	Acid Brush - Metal handle	3/8"	144	1728



DUCT TAPE

- Silver cloth duct tape, single coated with a rubber pressure sensitive adhesive
- Individually wrapped rolls

PART NO.	TYPE	SIZE	MASTER
3389-100	General purpose, 7 Mil	48mm x 55m (2" x 60 yard)	24



ALUMINUM FOIL TAPE

- Used on insulation board and batts to maintain the integrity of the vapour barrier
- Can be used on irregular and curved surfaces
- Service temperatures of 0°F to 150°F

PART NO.	TYPE	SIZE	MASTER
3379-150	1.5 Mil	2" x 50 yard	24
3379-200	2.0 Mil, UL approved	2" x 50 yard	24



COLD WEATHER FAUCET COVER

- Insulates outdoor faucets in cold weather
- Made from 5/8" expanded polystyrene

PART NO.	MASTER
7538-001	40

BIN BOXES

- White corrugated board



PART NO.	SIZE	MASTER
7503-001	2" x 12" x 4"	24
7503-002	4" x 12" x 4"	24
7503-003	8" x 12" x 4"	24



WATER HEATER PANS - WITH DRAIN

- Durable .032 mil. (20 gauge) aluminum circular pans recommended for water heater protection.
- Will not rust
- 21/8" deep
- Pre-drilled with 1" drain kit

NEW

PART NO.	TYPE	MASTER
3360-026		10

GENUINE SLOAN FLUSH VALVE REPAIR PARTS

PART NO.	TYPE	MASTER
7575-001	A-156A Diaphragm - card	6
7575-002	A-15-A Molded disc - card	12
7575-003	A-36-A Closet inside parts kit - card	6
7575-004	A-37-A Urinal inside parts kit - card	6
7575-005	A-38-A Water saver closet parts kit - card	6
7575-006	A-19-AC Closet relief valve - card	6
7575-007	A-19-AU Urinal relief valve - card	6
7575-008	B-32-A Handle assembly - header bag	6
7575-009	B-50-A Handle repair kit - card	12
7575-010	H-541-AA 1" S.D. Stop repair kit - card	6
7575-011	H-543-AA 3/4" S.D. Stop repair kit - card	6
7575-012	V-500-AA 3/4" x 9" Urinal vacuum breaker kit - Bag	6
7575-013	V-500-AA 1 1/2" x 9" Closet vacuum breaker kit - bag	6
7575-014	V-551-A Vacuum breaker repair kit - card	6
7575-015	Deodorizing urinal screen 10 3/4" x 9" - bag	6
7575-017	#186 Urinal flush valve - box	1
7575-018	A-163-A Guide	12
7575-019	B-39 Seal	12
7575-020	A-56-A Diaphragm with A-29	12
7575-021	A-56-AA Diaphragm repair kit with A-29	6
7575-022	A-156-AA Diaphragm repair kit	6
7575-023	H-573 1" Cap CP	1
7575-024	H-582 3/4" Cap CP	1
7575-025	S-60-AU Piston assembly with S-21	1
7575-026	S-14-A Molded cup	12
7575-027	S-14-AA Crown/naval closet urinal washer set	6
7575-030	V-101-A Vacuum breaker repair kit	1
7575-031	V-500-A Vacuum breaker complete 1 1/2" x 3 1/16"	1
7575-032	G-101-A GEM Urinal piston	1
7575-033	G-111-A GEM Closet piston	1
7575-034	G-36-A GEM C.P. Handle assembly	1
7575-035	K-60-A Piston assembly with S-123-A	1



**NEW
PRODUCT LINE**

YELLOW ABS SOLVENT CEMENT

- For bonding ABS to ABS pipes for non-pressure applications
- CSA certified for ABS non-pressure applications



PART NO.	TYPE	SIZE	MASTER
3301-003	Can with dauber	473 ml	12
3301-004	Can with dauber	946 ml	12
3301-501	Can with dauber	118 ml	24
3301-502	Can with dauber	236 ml	24
3300-003	Flat top can	473 ml	12
3300-004	Flat top can	946 ml	12
3300-005	Flat top can	3.78 L	4

GREY PVC-40 SOLVENT CEMENT

- For bonding PVC to PVC pipes for both non-pressure and pressure applications
- Certified to NSF/ANSI 61
- LEED compliant
- CSA certified for PVC plastic pipe and fittings



PART NO.	TYPE	SIZE	MASTER
3305-001	Can with dauber	118 ml	24
3305-002	Can with dauber	236 ml	24
3305-003	Can with dauber	473 ml	12
3305-004	Can with dauber	946 ml	12
3303-003	Flat top can	473 ml	12
3303-004	Flat top can	946 ml	12
3303-005	Flat top can	3.78 L	4

GREY PVC-80 SOLVENT CEMENT

- For bonding PVC to PVC pipes for both non-pressure and pressure applications
- Certified to NSF/ANSI 61
- LEED compliant
- CSA certified for PVC plastic pipe and fittings



PART NO.	TYPE	SIZE	MASTER
3319-002	Can with dauber	236 ml	24
3319-003	Can with dauber	473 ml	12
3319-004	Can with dauber	946 ml	12
3319-005	Can with dauber	3.78 L	4

**NEW
PRODUCT LINE**



WHITE PVC/ABS TRANSITION SOLVENT CEMENT

- For bonding ABS/PVC transition joints for non-pressure components
- LEED compliant
- CSA certified for PVC/ABS transition joints in non-pressure applications

PART NO.	TYPE	SIZE	MASTER
3307-001	Can with dauber	118 ml	24
3307-002	Can with dauber	236 ml	24
3306-003	Can with dauber	473 ml	12



CLEAR MULTI USE SOLVENT CEMENT

- For CPVC/PVC/ABS plastic pipe and fittings

PART NO.	TYPE	SIZE	MASTER
3310-001	Can with dauber	118 ml	24



CLEAR CPVC SOLVENT CEMENT

- For bonding CPVC to CPVC pipes and fittings for hot and cold water applications
- Certified to NSF/ANSI 61
- LEED compliant
- CSA certified for CPVC pipe and fittings

PART NO.	TYPE	SIZE	MASTER
3308-001	Can with dauber	118 ml	24



CLEAR PRIMER CLEANER

- Used as a primer cleaner for ABS pipes & fittings and as a cleaner for PVC and CPVC pipes & fittings

PART NO.	TYPE	SIZE	MASTER
3314-001	Can	118 ml	24
3314-002	Can	236 ml	24
3314-003	Can	473 ml	12
3314-004	Can	946 ml	12



PURPLE PRIMER CLEANER

- Used as a primer for bonded areas before PVC and CPVC solvent cements are applied

PART NO.	TYPE	SIZE	MASTER
3315-003	Can	473 ml	12
3315-004	Can	946 ml	12



CONTAINERS

- Brush in can unit assembled

PART NO.	TYPE	SIZE	MASTER
3317-800	Empty can with brush	500 ml	12
3317-900	Empty can with brush	1 L	12



#67



#66



#68



#7A



#9AS



#675



#670

NO. 66, 67 AND 68 AUTO-VENTS AND ACCESSORIES

- No air chamber required
- Float-operated vents for installation on convector radiators, baseboard radiation, & radiant panels
- Designed for use where space is limited
- For use on systems with pressures up to 50 lbs

PART NO.	MAID-O-MIST #	DESCRIPTION	MASTER
6350-001	#67	1/8" I.P. male connection, 50 psi	144
6350-002	#66	1/8" I.P. male connection, 50 psi	144
6350-003	#68	1/4" I.P. male connection, 50 psi	144
6350-020	#7A	Connector for Safe Waste	10
6350-201	#67AS, with auto shutoff	1/8" I.P. male connection, 50 psi	144
6350-888		Caps for air vents	20
6350-999	#9AS	"Shortstop" Auto Shutoff for # 66, 67 & 68	10

NO. 670 AND 675 AUTO-VENTS

PART NO.	MAID-O-MIST #	DESCRIPTION	MASTER
6340-001	#675	1/8" I.P. male connection, 150 psi	100
6350-015	#670	High cap air vent	100

NO. 7 SERIES AUTO-VENTS

- For continuous venting of hot water heating systems and chilled water cooling systems
- The No. 7 Series Auto-Vents are reliable automatic air eliminating valves for concealed radiators, pipe lines, tanks, and other devices
- Install on mains, pipe lines, unit heaters, chillers, convectors, radiant panels, and coils



#7



#71



#74



#75



#77



#78

PART NO.	MAID-O-MIST #	DESCRIPTION	MASTER
6350-004	#7	1/8" I.P. female connection, 75 psi	100
6350-005	#71	1/4" I.P. male connection, 150 psi	100
6350-006	#74	1/4" I.P. female connection, 150 psi	100
6350-007	#75	1/2" female, 3/4" male I.P. combination, 150 psi	100
6350-008	#77	1/8" I.P. female, 1/8" female side, 75 psi	12
6350-009	#78	1/8" I.P. male connection, 75 psi	100

NO 27 AND 37 AUTO-VENTS

- For automatically venting radiators, convectors, fan coil units, or baseboard radiation
- No air chamber is necessary



#27



#37

PART NO.	MAID-O-MIST #	DESCRIPTION	MASTER
6350-010	#27	1/8" I.P. female side connection, 50 psi	100
6350-011	#37	1/8" I.P. male bottom connection, 50 psi	100

NO. 72 AUTO-VENTS

- Expansion type
- For vertical or horizontal mounting
- For convectors, baseboard and free-standing radiation



#72

PART NO.	MAID-O-MIST #	DESCRIPTION	MASTER
6350-012	#72	1/8" I.P. male connection, 75 psi	24

MANUAL VENTS

- Designed for use on free-standing or baseboard radiators, convectors, or high points in a hot water heating system where air tends to collect.



#95

PART NO.	MAID-O-MIST #	DESCRIPTION	INNER	MASTER
6340-501		1/8" I.P. male connection, wheel handle	100	1000
6340-502		1/8" I.P. male connection, screwdriver slot	100	1000
6350-014	#95	Push-button manual vent, 50 psi	1	24

FLOAT CONTROL VALVES

- Precision designed to fill requirements for humidifying units, pan fillers, air conditioning equipment, evaporative coolers and other application where dependable water level control is essential in limited space to meet various operating conditions



#52



#51



#85

PART NO.	MAID-O-MIST #	DESCRIPTION	MASTER
6350-013	#52	Red brass float, 1 gallon per minute capacity	12
6350-018	#85	"Water Boy" Safety Feeder	12
6350-019	#51	Plastic float, 1/2 gallon per minute capacity	12
6350-021	#59	Plastic float, 1/2 gallon per minute capacity	12
6350-913		Float only for #52	12
6350-590	5900	Water Boy Valve	12

MAID-O-MIST - "JACOBUS" STEAM VENTS

- Self-adjusting thermostatic control
- Reduces radiator noise
- Assures even heat distribution
- Float to prevent water escape
- Lowers fuel consumption & costs



#40M



#5

	PART NO.	MAID-O-MIST #	TYPE	PIPE SIZE	VENT SIZE	MASTER
NEW	6351-002	#40M	Vertical Steam Vent	1/8"		12
	6351-501	#4	Angle	1/8"	.040"	12
	6351-502	#5	Angle	1/8"	.070"	12
	6351-503	#5	Straight	1/8"	.070"	12
	6351-504	#5	Straight	1/4"	.070"	12
	6351-505	#6	Angle	1/8"	.0935"	12
	6351-506	#6	Straight	1/8"	.0935"	12
	6351-507	#6	Straight	1/4"	.0935"	12
	6351-508	C	Angle	1/8"	.1285"	12
	6351-509	C	Straight	1/8"	.1285"	12
	6351-510	C	Straight	1/4"	.1285"	12
	6351-511	D	Angle	1/8"	.1850"	12
	6351-512	D	Straight	1/8"	.1850"	12
	6351-513	D	Straight	1/4"	.1850"	12
	6351-901	#1	Straight Main Vent	1/2" x 3/4"	.1850"	12

FITTINGS AND NIPPLES

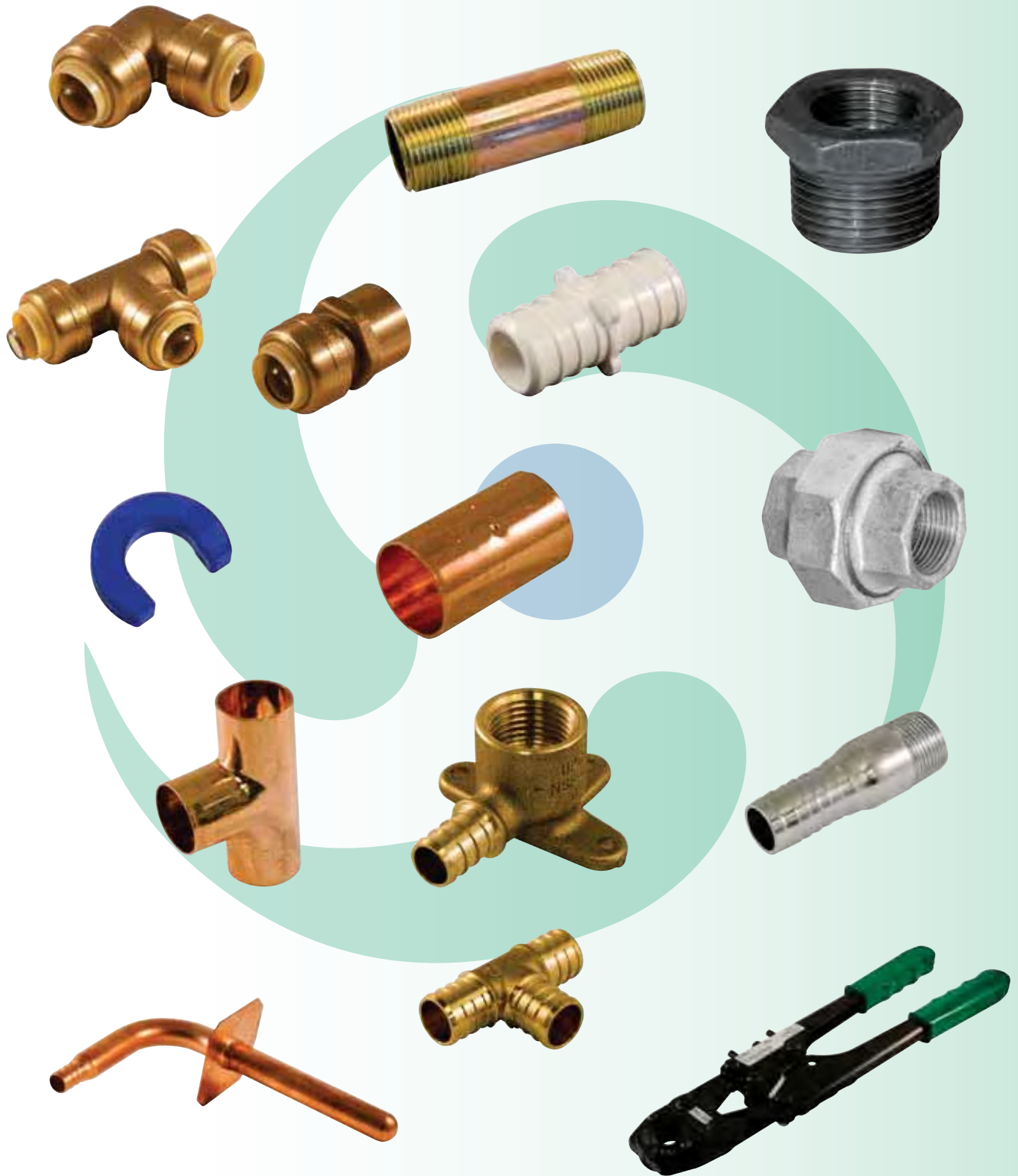

FITTINGS AND NIPPLES	PAGE
COPPERTUBE COILS	4-15
CORPORATION UNIONS	4-15
CRIMPTOOLS	4-9
INSERT FITTINGS - GALVANIZED STEEL	4-28
J-CLAMPS	4-8
MANIFOLDS	4-8
PEX CINCH CLAMPS	4-7
PEX CRIMP RINGS	4-7
PEX PRESS SLEEVES	4-7
PEX STUB OUT ELBOWS	4-8
PIPE MERCHANT COUPLINGS - GALVANIZED STEEL	4-28
PIPE CUTTERS	4-9
PIPE FITTINGS	
BAR STOCK	4-14
BLACK MALLEABLE IRON	4-20, 4-21
CAST BRASS	4-13, 4-14
COPPER	4-10 to 4-13
GALVANIZED MALLEABLE IRON	4-24, 4-25
PEX - BRASS	4-3 to 4-6
PEX - PLASTIC	4-4, 4-6
PEX x COMPRESSION	4-7
PUSH-FIT	4-1, 4-2
THREADED BRONZE	4-16, 4-17
PIPE NIPPLES	
BLACK STEEL	4-22, 4-23
GALVANIZED STEEL	4-26, 4-27
PVC	4-19
THREADED BRONZE	4-18
SUPPORTS & BRACKETS	4-8

Fittings & Nipples

**NEW
PRODUCT LINE**

PUSH FITTINGS - LEAD FREE

- Lead free brass construction
- Easy installation - no solder, flux or glues required
- Joins copper, CPVC and PEX tubing in any combination
- cUPC certified
- Meets NSF/ANSI 372 lead free standard

PART NO.	TYPE	SIZE	BAG	INNER	MASTER
9492-003	90° Elbow	1/2"	5	25	100
9492-004	90° Elbow	3/4"	5	25	100
9492-005	90° Elbow	1"	5	25	100
9492-043	90° Elbow	3/4" x 1/2"	5	25	100
9492-703	90° Elbow - Push x MIP	1/2"	5	25	100
9492-704	90° Elbow - Push x MIP	3/4"	5	25	100
9492-803	90° Elbow - Push x FIP	1/2"	5	25	100
9492-804	90° Elbow - Push x FIP	3/4"	5	25	100
9492-903	90° Elbow - Drop-ear	1/2"	5	25	100
9492-203	Coupling	1/2"	5	25	100
9492-204	Coupling	3/4"	5	25	100
9492-205	Coupling	1"	5	25	100
9492-243	Coupling	3/4" x 1/2"	5	25	100
9492-254	Coupling	1" x 3/4"	5	25	100
9482-003	Slip Coupling	1/2"	5	25	100
9482-004	Slip Coupling	3/4"	5	25	100
9492-303	Cap	1/2"	5	25	100
9492-304	Cap	3/4"	5	25	100
9492-305	Cap	1"	5	25	100
9492-403	Tee	1/2"	5	25	100
9492-404	Tee	3/4"	5	25	100
9492-405	Tee	1"	5	25	100
9492-433	Tee	3/4" x 1/2" x 1/2"	5	25	100
9492-434	Tee	3/4" x 1/2" x 3/4"	5	25	100
9492-443	Tee	3/4" x 3/4" x 1/2"	5	25	100
9492-454	Tee	1" x 1" x 3/4"	5	25	100
9492-503	Female Adapter	1/2"	5	25	100
9492-504	Female Adapter	3/4"	5	25	100
9492-505	Female Adapter	1"	5	25	100
9492-534	Female Adapter	1/2" x 3/4"	5	25	100
9492-603	Male Adapter	1/2"	5	25	100
9492-604	Male Adapter	3/4"	5	25	100
9492-605	Male Adapter	1"	5	25	100
9492-634	Male Adapter	1/2" x 3/4"	5	25	100
9492-654	Male Adapter	1" x 3/4"	5	25	100

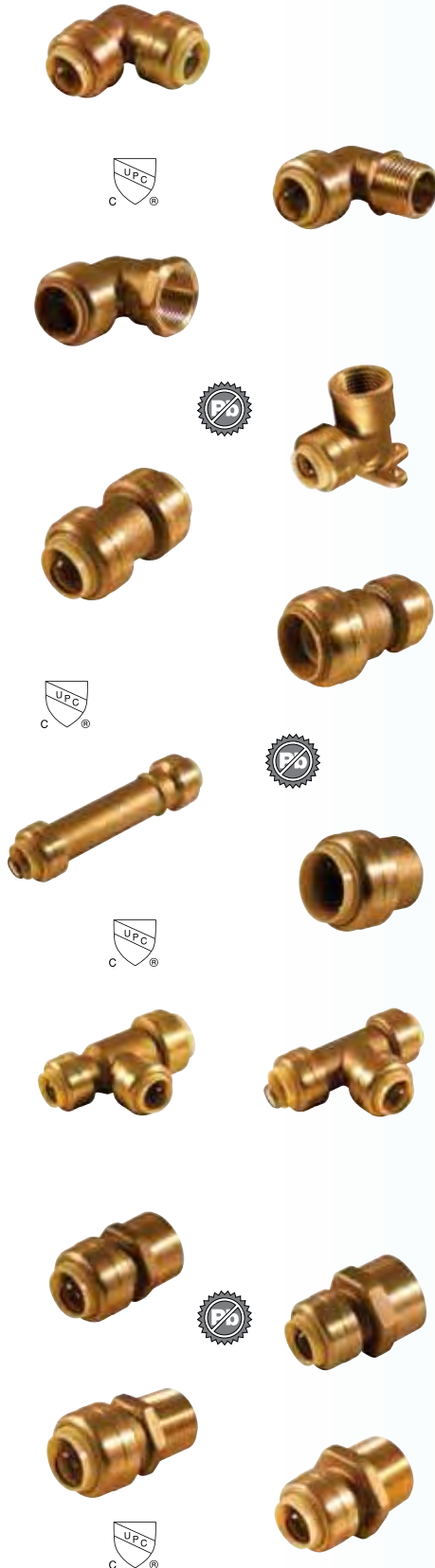

Fittings & Nipples

**NEW
PRODUCT LINE**

STOP VALVE TEE ADAPTERS - PUSH-FIT - LEAD FREE



- Lead free brass construction, use on hot or cold water
- Swivel screw connection, no drilling or extra valves required
- Creates a branch outlet from any supply stop
- Use when installing an ice maker, dishwasher, under-the-counter water filter or any other appliance that uses 1/4" or 3/8" O.D. copper or plastic tubing

PART NO.	INLET	OUTLET	BAG	INNER	MASTER
9494-915	3/8" O.D. Fem. Comp. x 3/8" O.D. Push	3/8" O.D. Push	5	25	100
9494-916	3/8" O.D. Fem. Comp. x 3/8" O.D. Push	1/4" O.D. Push	5	25	100

PUSH-FIT x COMPRESSION FITTINGS - LEAD FREE



- Lead free brass construction
- Easy installation - no solder, flux or glues required
- Joins copper, CPVC and PEX tubing in any combination
- cUPC certified
- Meets NSF/ANSI 372 lead free standard

PART NO.	INLET	OUTLET	BAG	INNER	MASTER
9495-022	3/8" O.D. Push	3/8" O.D. Comp.	5	25	100
9495-032	5/8" O.D. Push	3/8" O.D. Comp.	5	25	100

FAUCET & TOILET ADAPTERS - PUSH-FIT - LEAD FREE



- Lead free brass construction
- Easy installation - no solder, flux or glues required
- Joins copper, CPVC and PEX tubing in any combination
- cUPC certified
- Meets NSF/ANSI 372 lead free standard

PART NO.	TYPE	INLET	OUTLET	BAG	INNER	MASTER
9496-703	Faucet	5/8" O.D. Push	1/2" FIP	5	25	100
9496-803	Toilet	5/8" O.D. Push	7/8" BC	5	25	100



WATER HEATER INSTALLATION KITS - PUSH-FIT - LEAD FREE

- Included two push-fit female adapters and one push-fit removal tool
- For use with copper, PEX & CPVC tubing
- Meets NSF/ANSI 372 lead free standard

PART NO.	TYPE	SIZE	BAG	INNER	MASTER
9493-534	Push-Fit x FIP	1/2" x 3/4"	5	25	100
9493-544	Push-Fit x FIP	3/4" x 3/4"	5	25	100

REMOVAL TOOLS - PUSH-FIT



- For use with copper, PEX & CPVC tubing

PART NO.	TYPE	SIZE	INNER	MASTER
9484-003	Push-Fit	1/2"	50	500
9484-004	Push-Fit	3/4"	50	500
9484-005	Push-Fit	1"	50	500

PEX FITTINGS - BRASS

• Brass insert fittings, for use with cross-linked polyethylene (PEX) tubing

• CSA certified to the requirements of NSF/ANSI 61-4

PART NO.	TYPE	SIZE	INNER	MASTER
9276-003	Coupling	1/2"	50	1000
9276-004	Coupling	3/4"	25	500
9276-005	Coupling	1"	25	300
9276-043	Coupling	3/4" x 1/2"	50	500
9276-054	Coupling	1" x 3/4"	50	400
9277-033	90° Elbow	1/2"	50	750
9277-043	90° Elbow	3/4" x 1/2"	25	500
9277-044	90° Elbow	3/4"	25	500
9277-055	90° Elbow	1"	25	200
9277-633	90° Elbow - PEX x Male Threaded	1/2" x 1/2"	25	500
9277-733	90° Elbow - PEX x Male Sweat	1/2" x 1/2"	25	750
9277-734	90° Elbow - PEX x Female Sweat	1/2" x 3/4"	25	100
9277-933	90° Drop ear elbow - PEX x FIP	1/2" x 1/2"	25	200
9278-333	Tee	1/2"	50	500
9278-334	Tee	1/2" x 1/2" x 3/4"	25	250
9278-433	Tee	3/4" x 1/2" x 1/2"	25	250
9278-434	Tee	3/4" x 1/2" x 3/4"	25	250
9278-443	Tee	3/4" x 3/4" x 1/2"	25	250
9278-444	Tee	3/4"	25	250
9278-535	Tee	1" x 1/2" x 1"	25	200
9278-544	Tee	1" x 3/4" x 3/4"	25	200
9278-545	Tee	1" x 3/4" x 1"	25	200
9278-553	Tee	1" x 1" x 1/2"	25	200
9278-554	Tee	1" x 1" x 3/4"	25	200
9278-555	Tee	1"	25	200
9279-003	Plug	1/2"	100	2000
9279-004	Plug	3/4"	50	1000
9279-005	Plug	1"	50	500
9281-033	Male Adapter - P x M	1/2"	25	400
9281-034	Male Adapter - P x M	1/2" x 3/4"	25	250
9281-043	Male Adapter - P x M	3/4" x 1/2"	25	300
9281-044	Male Adapter - P x M	3/4"	25	300
9281-054	Male Adapter - P x M	1" x 3/4"	15	120
9281-055	Male Adapter - P x M	1"	25	150
9281-903	Male Sweat Adapter	1/2"	50	1000
9281-904	Male Sweat Adapter	3/4"	25	400
9281-905	Male Sweat Adapter	1"	25	200
9281-934	Male Sweat Adapter	1/2" x 3/4"	25	400
9281-943	Male Sweat Adapter	3/4" x 1/2"	25	400



Fittings & Nipples

PEX FITTINGS - BRASS

PART NO.	TYPE	SIZE	INNER	MASTER
9283-033	Female Adapter - P x F	1/2"	25	400
9283-034	Female Adapter - P x F	1/2" x 3/4"	25	250
9283-043	Female Adapter - P x F	3/4" x 1/2"	25	250
9283-044	Female Adapter - P x F	3/4"	25	250
9283-055	Female Adapter - P x F	1"	25	150
9283-903	Female Sweat Adapter	1/2"	50	1000
9283-904	Female Sweat Adapter	3/4"	25	500
9283-905	Female Sweat Adapter	1"	25	200
9283-603	PEX x PB Adapter Kit	1/2"	50	1000
9283-604	PEX x PB Adapter Kit	3/4"	25	500
9283-703	Lavatory Adapter - PEX x FIP	1/2" x 1/2"	25	400
9283-704	Lavatory Adapter - PEX x FIP	3/4" x 3/4"	25	250
9283-803	Toilet Adapter - PEX x BC	1/2" x 7/8 "	25	250

PEX FITTINGS - PLASTIC

PART NO.	TYPE	SIZE	INNER	MASTER
9250-003	Coupling	1/2"	50	1000
9250-004	Coupling	3/4"	50	600
9250-005	Coupling	1"	20	200
9250-043	Coupling	3/4" x 1/2"	50	1000
9251-003	90° Elbow	1/2"	50	500
9251-004	90° Elbow	3/4"	25	350
9251-005	90° Elbow	1"	10	100
9252-333	Tee	1/2"	50	400
9252-433	Tee	3/4" x 1/2" x 1/2"	25	300
9252-434	Tee	3/4" x 1/2" x 3/4"	25	300
9252-443	Tee	3/4" x 3/4" x 1/2"	25	300
9252-444	Tee	3/4"	25	250
9252-553	Tee	1" x 1" x 1/2"	10	100
9252-554	Tee	1" x 1" x 3/4"	10	100
9252-555	Tee	1"	25	300
9253-033	Male Adapter	1/2"	50	500
9253-034	Male Adapter	1/2" x 3/4"	25	400
9253-043	Male Adapter	3/4" x 1/2"	50	300
9253-044	Male Adapter	3/4"	25	350
9253-055	Male Adapter	1"	25	200
9254-033	Female Adapter	1/2"	25	400
9254-044	Female Adapter	3/4"	25	200
9255-003	Plug	1/2"	100	2000
9255-004	Plug	3/4"	100	1000
9255-005	Plug	1"	25	500



PEX FITTINGS - BRASS - BAR CODED

• Brass insert fittings, for use with cross-linked polyethylene (PEX) tubing

• CSA certified to the requirements of NSF/ANSI 61-4



RETAIL	TYPE	SIZE	INNER	MASTER
9676-003	Coupling	1/2"	25	800
9676-004	Coupling	3/4"	25	400
9676-043	Coupling	3/4" x 1/2"	25	400
9677-033	90° Elbow	1/2"	25	600
9677-043	90° Elbow	3/4" x 1/2"	25	250
9677-044	90° Elbow	3/4"	25	400
9677-833	90° Elbow	1/2" x 1/2"	25	250
9677-933	90° Drop ear elbow	1/2" x 1/2"	25	200
9677-943	90° Drop ear elbow	3/4" x 1/2"	25	200
9678-333	Tee	1/2"	25	400
9678-334	Tee	1/2" x 1/2" x 3/4"	25	200
9678-433	Tee	3/4" x 1/2" x 1/2"	25	200
9678-434	Tee	3/4" x 1/2" x 3/4"	25	200
9678-443	Tee	3/4" x 3/4" x 1/2"	25	200
9678-444	Tee	3/4"	25	200
9679-003	Plug	1/2"	25	1400
9679-004	Plug	3/4"	25	800
9681-033	Male Adapter - P x M	1/2"	25	400
9681-034	Male Adapter - P x M	1/2" x 3/4"	25	250
9681-043	Male Adapter - P x M	3/4" x 1/2"	25	250
9681-044	Male Adapter - P x M	3/4"	25	250
9681-903	Male Sweat Adapter	1/2"	25	700
9681-904	Male Sweat Adapter	3/4"	25	300
9681-934	Male Sweat Adapter	1/2" x 3/4"	25	300
9681-943	Male Sweat Adapter	3/4" x 1/2"	25	200
9683-033	Female Adapter - P x F	1/2"	25	400
9683-034	Female Adapter - P x F	1/2" x 3/4"	25	250
9683-043	Female Adapter - P x F	3/4" x 1/2"	25	200
9683-044	Female Adapter - P x F	3/4"	25	250
9683-903	Female Sweat Adapter	1/2"	25	700
9683-904	Female Sweat Adapter	3/4"	25	400
9283-603	PEX x PB Adapter Kit	1/2"	50	1000
9283-604	PEX x PB Adapter Kit	3/4"	25	500
9683-703	Lavatory Adapter - PEX x FIP	1/2"	25	300
9683-704	Lavatory Adapter - PEX x FIP	3/4"	25	200
9683-753	Lavatory Adapter - PEX x FIP Less Nut	1/2"	25	250
9683-803	Toilet Adapter - PEX x BC	1/2" x 7/8"	25	300



PEX FITTINGS - PLASTIC - BAR CODED

RETAIL	TYPE	SIZE	INNER	MASTER
9750-003	Coupling	1/2"	25	1000
9750-004	Coupling	3/4"	25	600
9750-043	Coupling	3/4" x 1/2"	25	600
9751-003	90° Elbow	1/2"	25	500
9751-004	90° Elbow	3/4"	25	350
9752-333	Tee	1/2"	25	400
9752-433	Tee	3/4" x 1/2" x 1/2"	25	300
9752-434	Tee	3/4" x 1/2" x 3/4"	25	300
9752-443	Tee	3/4" x 3/4" x 1/2"	25	300
9752-444	Tee	3/4"	25	250
9753-033	Male Adapter	1/2"	25	500
9753-034	Male Adapter	1/2" x 3/4"	25	400
9753-043	Male Adapter	3/4" x 1/2"	25	300
9753-044	Male Adapter	3/4"	25	350
9754-033	Female Adapter	1/2"	25	400
9754-044	Female Adapter	3/4"	25	200
9755-003	Plug	1/2"	25	2000
9755-004	Plug	3/4"	25	1000

PEX FITTINGS - BRASS - CONTRACTOR PACKS

NEW

- Brass insert fittings, for use with cross-linked polyethylene (PEX) tubing
- CSA certified to the requirements of NSF/ANSI 61-4

RETAIL	TYPE	SIZE	INNER	MASTER
9276-803	Coupling - Pack of 25	1/2"	1	24
9276-804	Coupling - Pack of 25	3/4"	1	12
9277-833	90° Elbow - Pack of 25	1/2"	1	24
9277-844	90° Elbow - Pack of 25	3/4"	1	12
9278-833	Tee - Pack of 25	1/2"	1	12
9278-844	Tee - Pack of 25	3/4"	1	12
9279-803	Plug - Pack of 25	1/2"	1	24
9279-804	Plug - Pack of 25	3/4"	1	6



Fittings & Nipples

PEX CRIMP RINGS - COPPER

PART NO.	TYPE	SIZE	BAG	INNER	MASTER
9284-003	Bulk	1/2"	100	1000	4000
9284-004	Bulk	3/4"	50	500	2000
9284-005	Bulk	1"	50	250	1000
9284-703	Pack of 100	1/2"	n/a	1	24
9284-704	Pack of 100	3/4"	n/a	1	12
9284-803	Bag of 25	1/2"	n/a	1	60
9284-804	Bag of 25	3/4"	n/a	1	32
9284-805	Bag of 25	1"	n/a	1	20
9684-503	Bag of 10	1/2"	n/a	1	150
9684-504	Bag of 10	3/4"	n/a	1	100



PEX CINCH CLAMPS - STAINLESS STEEL

PART NO.	TYPE	SIZE	INNER	MASTER
9287-003	Bag of 10	1/2"	100	500
9287-004	Bag of 5	3/4"	50	500
9287-005	Bag of 5	1"	50	250
9287-903	Bag of 50	1/2"	20	100
9287-904	Bag of 50	3/4"	10	50



NEW

PEX PRESS SLEEVES - STAINLESS STEEL

PART NO.	TYPE	SIZE	INNER	MASTER
9289-003	Bulk	1/2"	100	5000
9289-004	Bulk	3/4"	50	3200
9289-005	Bulk	1"	25	1600
9689-503	Bag of 10	1/2"	10	500
9689-504	Bag of 10	3/4"	5	320



PEX x COMPRESSION FITTINGS

PART NO.	TYPE	SIZE	SIZE	INNER	MASTER
9282-032	Straight	1/2" PEX	3/8" O.D. Comp	50	500
9282-132	Angle	1/2" PEX	3/8" O.D. Comp	50	500
9282-237	Straight	1/2" PEX	5/8" O.D. Comp	25	250





J-CLAMPS - WITH NAIL

PART NO.	TYPE	SIZE	INNER	MASTER
3618-003	Bulk	1/2"	100	4800
3618-004	Bulk	3/4"	100	4000
3618-005	Bulk	1"	100	2500
3618-703	Bag of 10	1/2"	1	480
3618-704	Bag of 10	3/4"	1	400
3618-705	Bag of 10	1"	1	250

NEW

MANIFOLDS

PART NO.	TYPE	SIZE	INNER	MASTER
9288-114	3/4" PEX inlet x close end x 4 branch	1/2" PEX	1	80
9288-116	3/4" PEX inlet x close end x 6 branch	1/2" PEX	1	60
9288-118	3/4" PEX inlet x close end x 8 branch	1/2" PEX	1	40
9288-110	3/4" PEX inlet x close end x 10 branch	1/2" PEX	1	30
9288-214	3/4" Sweat inlet x close end x 4 branch	1/2" PEX	1	80
9288-216	3/4" Sweat inlet x close end x 6 branch	1/2" PEX	1	60

NEW

PEX STUB OUT ELBOWS

PART NO.	TYPE	SIZE	INNER	MASTER
9290-006	Less Flange	1/2" PEX x 3 1/2" x 6"	10	200
9290-008	Less Flange	1/2" PEX x 3 1/2" x 8"	10	200
9290-106	With Flange	1/2" PEX x 3 1/2" x 6"	10	200
9290-108	With Flange	1/2" PEX x 3 1/2" x 8"	10	150

SUPPORTS & BRACKETS

PART NO.	TYPE	SIZE	INNER	MASTER
3221-704	Turn-out support for 3/8" or 1/2" tube		10	300
3221-404	Holdrite inserts for 1/2" CTS		1	100
3221-103	Pexrite Bracket - Galvanized	20"	5	300



Fittings & Nipples

CRIMP TOOLS - FOR COPPER CRIMP RINGS

PART NO.	TYPE	SIZE	INNER	MASTER
9285-203	Single Crimp Tool	1/2"	1	10
9285-204	Single Crimp Tool	3/4"	1	10
9285-334	Combo Crimp Tool	1/2" & 3/4"	1	10
9285-400	Multi-Function Crimp Tool	3/8", 1/2", 3/4" & 1"	1	5
9285-458	Jaw for 9285-400	5/8"	1	25
9285-603	Angle Head - Spring Loaded Handle	1/2"	1	20
9285-604	Angle Head - Spring Loaded Handle	3/4"	1	20
9285-653	Angle Head - One-Hand Operation	1/2"	1	20
9285-654	Angle Head - One-Hand Operation	3/4"	1	20
9285-100	4-in-1 Pocket Crimper	3/8", 1/2", 3/4" & 1"	1	10
9285-500	PEX Ring Removal Tool	3/8", 1/2", 3/4" & 1"	1	6



Single



Combo



Spring Handle



4-in-1



Multi-Function



Removal Tool



One-Hand Operation



Ratchet Style



Angle Head



Ratchet Style



Reversible Blade



Triangular Blade

CRIMP TOOLS - FOR STAINLESS STEEL PRESS SLEEVES

NEW

PART NO.	TYPE	SIZE	INNER	MASTER
9285-903	Ratchet Style - 14" Handles	1/2"	1	10
9285-904	Ratchet Style - 14" Handles	3/4"	1	10
9285-905	Ratchet Style - 14" Handles	1"	1	10
9285-934	1/2" & 3/4" Combo Ratchet Style 14" Handles	1/2" & 3/4"	1	10
9285-953	Ratchet Style - 12" Short Handles	1/2"	1	10
9285-954	Ratchet Style - 12" Short Handles	3/4"	1	10
9285-983	Angle Head - Spring Loaded Handle	1/2"	1	20
9285-984	Angle Head - Spring Loaded Handle	3/4"	1	20

CRIMP TOOLS - FOR STAINLESS STEEL CINCH CLAMPS

PART NO.	TYPE	SIZE	INNER	MASTER
9285-700	Ratchet Style	3/8" to 1"	1	30

PIPE CUTTERS

PART NO.	TYPE	SIZE	INNER	MASTER
9286-100	Plastic Pipe	1/8" to 1"	1	50
9286-199	Replacement Blade for 9286-100		1	50
9286-200	Plastic Pipe - Reversible Blade	1/8" to 1"	1	50
9286-299	Replacement Blade for 9286-200		1	50
9286-300	Plastic Pipe - Triangular Blade	1/8" to 1"	1	72

COPPER FITTINGS

• Individually bagged with bar code label

PART NO.	TYPE	SIZE	INNER	MASTER
9000-001	Coupling - C x C	1/4"	20	600
9000-002	Coupling - C x C	3/8"	25	500
9000-003	Coupling - C x C	1/2"	25	800
9000-004	Coupling - C x C	3/4"	25	400
9000-005	Coupling - C x C	1"	25	100
9000-006	Coupling - C x C	1 1/4"	20	200
9000-007	Coupling - C x C	1 1/2"	10	100
9000-021	Coupling - C x C	3/8" x 1/4"	5	250
9000-031	Coupling - C x C	1/2" x 1/4"	25	250
9000-032	Coupling - C x C	1/2" x 3/8"	25	250
9000-043	Coupling - C x C	3/4" x 1/2"	25	100
9000-054	Coupling - C x C	1" x 3/4"	25	250
9000-065	Coupling - C x C	1 1/4" x 1"	20	100
9000-803	Coupling - C x C - Bag of 25	1/2"	1	10
9000-903	Coupling - C x C - Bag of 50	1/2"	1	10
9000-704	Coupling - C x C - Bag of 10	3/4"	1	40
9001-003	Male Adapter - C x M	1/2"	25	300
9001-004	Male Adapter - C x M	3/4"	25	250
9001-005	Male Adapter - C x M	1"	25	125
9001-007	Male Adapter - C x M	1 1/2"	10	100
9001-031	Male Adapter - C x M	1/2" x 1/4"	20	200
9001-032	Male Adapter - C x M	1/2" x 3/8"	20	200
9001-034	Male Adapter - C x M	1/2" x 3/4"	25	500
9001-035	Male Adapter - C x M	1/2" x 1"	10	100
9001-043	Male Adapter - C x M	3/4" x 1/2"	40	400
9001-053	Male Adapter - C x M	1" x 1/2"	10	100
9001-054	Male Adapter - C x M	1" x 3/4"	10	100
9001-056	Male Adapter - C x M	1" x 1 1/4"	10	100
9001-057	Male Adapter - C x M	1" x 1 1/2"	10	100
9001-503	Male Adapter - FTG x M	1/2"	25	400
9001-504	Male Adapter - FTG x M	3/4"	25	500
9001-505	Male Adapter - FTG x M	1"	25	125
9002-003	Female Adapter - C x F	1/2"	25	150
9002-004	Female Adapter - C x F	3/4"	25	150
9002-005	Female Adapter - C x F	1"	10	100
9002-006	Female Adapter - C x F	1 1/4"	10	100
9002-007	Female Adapter - C x F	1 1/2"	10	100
9002-031	Female Adapter - C x F	1/2" x 1/4"	25	250
9002-032	Female Adapter - C x F	1/2" x 3/8"	25	250
9002-034	Female Adapter - C x F	1/2" x 3/4"	25	250
9002-043	Female Adapter - C x F	3/4" x 1/2"	25	500
9002-503	Female Adapter - FTG x F	1/2"	25	500
9002-504	Female Adapter - FTG x F	3/4"	15	150
9002-505	Female Adapter - FTG x F	1"	25	125

COPPER FITTINGS

• Individually bagged with bar code label



PART NO.	TYPE	SIZE	INNER	MASTER
9003-001	90° Elbow - C x C	1/4"	25	800
9003-002	90° Elbow - C x C	3/8"	25	800
9003-003	90° Elbow - C x C	1/2"	25	600
9003-004	90° Elbow - C x C	3/4"	25	250
9003-005	90° Elbow - C x C	1"	25	200
9003-006	90° Elbow - C x C	1 1/4"	25	100
9003-007	90° Elbow - C x C	1 1/2"	10	50
9003-032	90° Elbow - C x C	1/2" x 3/8"	50	500
9003-043	90° Elbow - C x C	3/4" x 1/2"	25	400
9003-076	90° Elbow - C x C	1 1/2" x 1 1/4"	25	400
9003-803	90° Elbow - C x C - Bag of 25	1/2"	1	10
9003-903	90° Elbow - C x C - Bag of 50	1/2"	1	10
9003-704	90° Elbow - C x C - Bag of 10	3/4"	1	25
9003-503	90° Street Elbow - FTG x C	1/2"	25	500
9003-504	90° Street Elbow - FTG x C	3/4"	25	250
9003-505	90° Street Elbow - FTG x C	1"	15	150
9003-506	90° Street Elbow - FTG x C	1 1/4"	5	50
9003-507	90° Street Elbow - FTG x C	1 1/2"	5	50
9004-003	45° Elbow - C x C	1/2"	25	500
9004-004	45° Elbow - C x C	3/4"	25	250
9004-005	45° Elbow - C x C	1"	30	150
9004-006	45° Elbow - C x C	1 1/4"	25	50
9004-007	45° Elbow - C x C	1 1/2"	5	50
9004-803	45° Elbow - C x C - Bag of 25	1/2"	1	10
9004-903	45° Elbow - C x C - Bag of 50	1/2"	1	10
9004-704	45° Elbow - C x C - Bag of 10	3/4"	1	30
9004-503	45° Street Elbow - FTG x C	1/2"	25	500
9004-504	45° Street Elbow - FTG x C	3/4"	25	125
9004-505	45° Street Elbow - FTG x C	1"	10	100
9005-031	Bushing - FTG x C	1/2" x 1/4"	25	250
9005-032	Bushing - FTG x C	1/2" x 3/8"	15	300
9005-043	Bushing - FTG x C	3/4" x 1/2"	25	250
9005-054	Bushing - FTG x C	1" x 3/4"	10	200
9005-063	Bushing - FTG x C	1 1/4" x 1/2"	10	200
9005-075	Bushing - FTG x C	1 1/2" x 1"	10	100
9005-076	Bushing - FTG x C	1 1/2" x 1 1/4"	10	100
9005-553	Bushing - FTG x C	1" x 1/2"	25	150

COPPER FITTINGS

• Individually bagged with bar code label



PART NO.	TYPE	SIZE	INNER	MASTER
9006-001	Tee - C x C x C	1/4"	25	500
9006-002	Tee - C x C x C	3/8"	25	500
9006-003	Tee - C x C x C	1/2"	25	500
9006-004	Tee - C x C x C	3/4"	25	75
9006-005	Tee - C x C x C	1"	20	100
9006-006	Tee - C x C x C	1 1/4"	5	50
9006-007	Tee - C x C x C	1 1/2"	5	50
9006-334	Tee - C x C x C	1/2" x 1/2" x 3/4"	20	200
9006-433	Tee - C x C x C	3/4" x 1/2" x 1/2"	25	200
9006-434	Tee - C x C x C	3/4" x 1/2" x 3/4"	25	100
9006-443	Tee - C x C x C	3/4" x 3/4" x 1/2"	25	300
9006-533	Tee - C x C x C	1" x 1/2" x 1/2"	5	50
9006-534	Tee - C x C x C	1" x 1/2" x 3/4"	5	50
9006-535	Tee - C x C x C	1" x 1/2" x 1"	5	50
9006-543	Tee - C x C x C	1" x 3/4" x 1/2"	5	50
9006-544	Tee - C x C x C	1" x 3/4" x 3/4"	15	90
9006-553	Tee - C x C x C	1" x 1" x 1/2"	10	100
9006-554	Tee - C x C x C	1" x 1" x 3/4"	10	100
9006-803	Tee - C x C x C - Bag of 25	1/2"	1	10
9006-903	Tee - C x C x C - Bag of 50	1/2"	1	9
9006-704	Tee - C x C x C - Bag of 10	3/4"	1	15
9007-003	Tube Cap	1/2"	25	500
9007-004	Tube Cap	3/4"	25	150
9007-005	Tube Cap	1"	20	200
9007-006	Tube Cap	1 1/4"	10	200
9007-007	Tube Cap	1 1/2"	15	150
9007-008	Tube Cap	2"	5	50
9007-803	Tube Cap - Bag of 25	1/2"	1	20
9007-903	Tube Cap - Bag of 50	1/2"	1	12
9007-704	Tube Cap - Bag of 10	3/4"	1	15
9008-003	Union	1/2"	25	250
9008-004	Union	3/4"	35	175
9008-005	Union	1"	10	100
9007-503	Test Cap - Bag of 25	1/2"	1	25



COPPER & CAST BRASS FITTINGS - DWV

• Individually bagged with bar code label

PART NO.	TYPE	SIZE	INNER	MASTER
9050-006	Coupling - Copper	1/4"	10	100
9050-007	Coupling - Copper	1/2"	20	100
9050-008	Coupling - Copper	2"	10	50
9050-086	Coupling - Cast Brass	2" x 1/4"	10	150
9052-007	Female Adapter - Cast Brass	1/2"	10	150
9052-008	Female Adapter - Cast Brass	2"	10	90
9152-006	Female Adapter - Cast Brass	1/4"	10	100
9053-006	90° Elbow - Copper	1/4"	20	160
9053-007	90° Elbow - Copper	1/2"	10	50
9053-008	90° Elbow - Copper	2"	5	50
9053-503	90° Street Elbow - Copper - FTG x C	1/2"	5	50
9054-006	45° Elbow - Cast Brass	1/4"	10	120
9054-007	45° Elbow - Copper	1/2"	10	50
9054-507	45° Street Elbow - Copper - FTG x C	1/2"	10	100
9055-076	Bushing - Cast Brass	1/2" x 1/4"	5	225
9055-086	Bushing - Cast Brass	2" x 1/4"	5	100
9055-087	Bushing - Cast Brass	2" x 1/2"	5	150
9057-006	Test Cap - Copper	1/4"	10	200
9057-007	Test Cap - Copper	1/2"	20	400
9057-008	Test Cap - Copper	2"	20	400
9059-006	Sanitary Tee - Cast Brass	1/4"	10	100
9059-007	Sanitary Tee - Cast Brass	1/2"	15	60
9059-008	Sanitary Tee - Cast Brass	2"	8	40
9151-006	Male Adapter - Cast Brass	1/4"	10	300
9151-007	Male Adapter - Cast Brass	1/2"	10	200
9151-008	Male Adapter - Cast Brass	2"	10	150
9159-006	Wye - Cast Brass	1/4"	15	60
9159-007	Wye - Cast Brass	1/2"	15	60
9159-008	Wye - Cast Brass	2"	8	40



CAST BRASS FITTINGS - LEAD FREE

• Individually bagged with bar code label

PART NO.	TYPE	SIZE	INNER	MASTER
9903-503	90° Elbow - C x F	1/2"	50	200
9903-504	90° Elbow - C x F	3/4"	15	90
9903-534	90° Elbow - C x F	1/2" x 3/4"	15	90
9903-703	90° Elbow - C x M	1/2"	50	300
9903-804	90° Drop Ear Elbow - C x F	3/4"	20	100
9903-903	90° Drop Ear Elbow - C x C	1/2"	20	200
9940-030	90° Drop Ear Elbow - FIP x Solder	1/2"	75	150
9440-030	90° Drop Ear Elbow - FIP x Solder *Not Lead Free*	1/2"	75	150
9906-503	Tee - C x C x F	1/2"	30	150
9906-504	Tee - C x C x F	3/4"	25	100
9906-332	Tee - C x C x F	1/2" x 1/2" x 3/8"	25	200
9906-443	Tee - C x C x F	3/4" x 3/4" x 1/2"	25	100
9907-434	Tee - F x F x C	3/4" x 1/2" x 3/4"	25	100
9907-443	Tee - F x F x C	3/4" x 3/4" x 1/2"	25	100
9907-444	Tee - F x F x C	3/4" x 3/4" x 3/4"	25	100
9908-404	Baseboard Tee - C x F x C	3/4" x 1/8" x 3/4"	25	200

BAR STOCK FITTINGS - LEAD FREE

• Brass alloy

• Individually bagged with bar code label

PART NO.	TYPE	SIZE	INNER	MASTER
9972-003	Union	1/2"	25	300
9972-004	Union	3/4"	25	200
9972-103	Female Adapter	1/2"	25	300
9972-104	Female Adapter	3/4"	25	250
9972-131	Female Adapter	1/2" x 1/4"	25	500
9972-132	Female Adapter	1/2" x 3/8"	25	500
9972-134	Female Adapter	1/2" x 3/4"	25	250
9972-143	Female Adapter	3/4" x 1/2"	25	250
9972-203	Male adapter	1/2"	25	400
9972-204	Male adapter	3/4"	25	250
9972-231	Male adapter	1/2" x 1/4"	25	300
9972-232	Male adapter	1/2" x 3/8"	25	250
9972-234	Male adapter	1/2" x 3/4"	25	300
9972-243	Male adapter	3/4" x 1/2"	25	250



NEW

CORPORATION UNIONS - LEAD FREE

• Brass alloy

• Individually bagged with bar code label

PART NO.	TYPE	SIZE	INNER	MASTER
9900-004	Comp. x Comp.	3/4"	10	60
9900-005	Comp. x Comp.	1"	6	36
9900-054	Comp. x Comp.	1" x 3/4"	6	36
9900-104	Comp. x MIP	3/4"	12	72
9900-105	Comp. x MIP	1"	12	72
9400-504	Stainless Steel Insert	3/4"	50	1000
9400-505	Stainless Steel Insert	1"	50	1000

COPPERTUBE COILS - UTILITY GRADE

• Utility grade coils are manufactured to ASTM B-68

PART NO.	SIZE	MASTER
9443-101	1/4" x 10 ft	10
9443-102	3/8" x 10 ft	6
9443-251	1/4" x 20 ft	6
9443-252	3/8" x 20 ft	5
9443-255	1/4" x 25 ft	5
9443-325	1/2" x 25 ft	4
9443-355	3/8" x 25 ft	4



COPPERTUBE COILS - REFRIGERATION GRADE

• Refrigeration grade coils are manufactured to ASTM B-280

PART NO.	SIZE	MASTER
9445-125	1/4" x 25 ft	5
9445-150	1/4" x 50 ft	5
9445-225	3/8" x 25 ft	10
9445-250	3/8" x 50 ft	5
9445-325	1/2" x 25 ft	10
9445-350	1/2" x 50 ft	5

Fittings & Nipples

THREADED BRONZE PIPE FITTINGS - LEAD FREE

• All fittings are individually bar coded

• Threaded ends comply with ANSI B1.20



90° Elbows

PART NO.	SIZE	BAG	BOX	MASTER
4490-000	1/8"	5	25	600
4490-001	1/4"	5	25	300
4490-002	3/8"	5	25	200
4490-003	1/2"	5	25	200
4490-004	3/4"	5	25	75
4490-005	1"	5	25	50
4490-006	1 1/4"	5	25	50
4490-007	1 1/2"	5		35
4490-008	2"	5		20

90° Street Elbows

PART NO.	SIZE	BAG	BOX	MASTER
4492-002	3/8"	5	25	200
4492-003	1/2"	5	25	100
4492-004	3/4"	5	25	75
4492-005	1"	5	25	50
4492-006	1 1/4"	5		40
4492-007	1 1/2"	5		35
4492-008	2"	5		20



90° Reducing Elbows

PART NO.	SIZE	BAG	BOX	MASTER
4490-020	3/8" x 1/8"	5	25	200
4490-021	3/8" x 1/4"	5	25	200
4490-032	1/2" x 3/8"	5	25	75
4490-043	3/4" x 1/2"	5	25	75
4490-054	1" x 3/4"	5	25	50

Tees

PART NO.	SIZE	BAG	BOX	MASTER
4493-000	1/8"	5	25	300
4493-001	1/4"	5	25	300
4493-002	3/8"	5	25	200
4493-003	1/2"	5	25	75
4493-004	3/4"	5	25	75
4493-005	1"	5	25	50
4493-006	1 1/4"	5		35
4493-007	1 1/2"	5		25
4493-008	2"	5		15



45° Elbows

PART NO.	SIZE	BAG	BOX	MASTER
4491-000	1/8"	5	25	600
4491-001	1/4"	5	25	300
4491-002	3/8"	5	25	200
4491-003	1/2"	5	25	200
4491-004	3/4"	5	25	75
4491-005	1"	5	25	50
4491-006	1 1/4"	5	25	50
4491-007	1 1/2"	5		40
4491-008	2"	5		25

Couplings

PART NO.	SIZE	BAG	BOX	MASTER
4494-000	1/8"	5	25	600
4494-001	1/4"	5	25	600
4494-002	3/8"	5	25	300
4494-003	1/2"	5	25	200
4494-004	3/4"	5	25	75
4494-005	1"	5	25	75
4494-006	1 1/4"	5	25	75
4494-007	1 1/2"	5	25	50
4494-008	2"	5		30

Fittings & Nipples

THREADED BRONZE PIPE FITTINGS - LEAD FREE

• All fittings are individually bar coded

• Threaded ends comply with ANSI B1.20



Reducer Couplings

PART NO.	SIZE	BAG	BOX	MASTER
4494-020	3/8" x 1/8"	5	25	300
4494-021	3/8" x 1/4"	5	25	300
4494-032	1/2" x 3/8"	5	25	200
4494-042	3/4" x 3/8"	5	25	75
4494-043	3/4" x 1/2"	5	25	75
4494-053	1" x 1/2"	5	25	75
4494-054	1" x 3/4"	5	25	75
4494-076	1 1/2" x 1 1/4"	5	25	50

Hex Reducing Bushings

PART NO.	SIZE	BAG	BOX	MASTER
4495-010	1/4" x 1/8"	5	25	600
4495-020	3/8" x 1/8"	5	25	600
4495-021	3/8" x 1/4"	5	25	600
4495-030	1/2" x 1/8"	5	25	300
4495-032	1/2" x 3/8"	5	25	300
4495-042	3/4" x 3/8"	5	25	200
4495-043	3/4" x 1/2"	5	25	200
4495-053	1" x 1/2"	5	25	75
4495-054	1" x 3/4"	5	25	75
4495-064	1 1/4" x 3/4"	5		120
4495-065	1 1/4" x 1"	5		120
4495-075	1 1/2" x 1"	5		120
4495-076	1 1/2" x 1 1/4"	5		120
4495-086	2" x 1 1/4"	5		65
4495-087	2" x 1 1/2"	5		65

Pipe Caps

PART NO.	SIZE	BAG	BOX	MASTER
4497-000	1/8"	5	25	600
4497-001	1/4"	5	25	600
4497-002	3/8"	5	25	300
4497-003	1/2"	5	25	300
4497-004	3/4"	5	25	200
4497-005	1"	5	25	75
4497-006	1 1/4"	5	25	100
4497-007	1 1/2"	5	25	100
4497-008	2"	5		70

Solid Pipe Plugs

PART NO.	SIZE	BAG	BOX	MASTER
4498-000	1/8"	5	25	600
4498-001	1/4"	5	25	600
4498-002	3/8"	5	25	600
4498-003	1/2"	5	25	300
4498-004	3/4"	5	25	200
4498-005	1"	5	25	75

Cored Pipe Plugs

PART NO.	SIZE	BAG	BOX	MASTER
4498-093	1/2"	5	25	300
4498-094	3/4"	5	25	200
4498-095	1"	5	25	75
4498-096	1 1/4"	5	25	100
4498-097	1 1/2"	5	25	100
4498-098	2"	5	25	100

Threaded Unions

PART NO.	SIZE	BAG	BOX	MASTER
4499-000	1/8"	5	25	200
4499-001	1/4"	5	25	100
4499-002	3/8"	5	25	75
4499-003	1/2"	5	25	75
4499-004	3/4"	5	25	50
4499-005	1"	5	25	50
4499-006	1 1/4"	5		35
4499-007	1 1/2"	5		25
4499-008	2"	5		15

Fittings & Nipples

THREADED BRONZE PIPE NIPPLES - LEAD FREE

- Individually bar coded
- All items packaged in inner packs of 5 and master packs of 25
- Pipe threads comply with ANSI B1.20.1

1/8"

PART NO.	LENGTH
4460-001	Close
4460-015	1 1/2"
4460-020	2"
4460-025	2 1/2"
4460-030	3"
4460-035	3 1/2"
4460-040	4"
4460-045	4 1/2"
4460-050	5"
4460-055	5 1/2"
4460-060	6"



1/2"

PART NO.	LENGTH
4463-001	Close
4463-015	1 1/2"
4463-020	2"
4463-025	2 1/2"
4463-030	3"
4463-035	3 1/2"
4463-040	4"
4463-045	4 1/2"
4463-050	5"
4463-055	5 1/2"
4463-060	6"

1 1/4"

PART NO.	LENGTH
4466-001	Close
4466-020	2"
4466-025	2 1/2"
4466-030	3"
4466-035	3 1/2"
4466-040	4"
4466-045	4 1/2"
4466-050	5"
4466-055	5 1/2"
4466-060	6"

1/4"

PART NO.	LENGTH
4461-001	Close
4461-015	1 1/2"
4461-020	2"
4461-025	2 1/2"
4461-030	3"
4461-035	3 1/2"
4461-040	4"
4461-045	4 1/2"
4461-050	5"
4461-055	5 1/2"
4461-060	6"



3/4"

PART NO.	LENGTH
4464-001	Close
4464-015	1 1/2"
4464-020	2"
4464-025	2 1/2"
4464-030	3"
4464-035	3 1/2"
4464-040	4"
4464-045	4 1/2"
4464-050	5"
4464-055	5 1/2"
4464-060	6"

1 1/2"

PART NO.	LENGTH
4467-001	Close
4467-020	2"
4467-025	2 1/2"
4467-030	3"
4467-035	3 1/2"
4467-040	4"
4467-045	4 1/2"
4467-050	5"
4467-055	5 1/2"
4467-060	6"

3/8"

PART NO.	LENGTH
4462-001	Close
4462-015	1 1/2"
4462-020	2"
4462-025	2 1/2"
4462-030	3"
4462-035	3 1/2"
4462-040	4"
4462-045	4 1/2"
4462-050	5"
4462-055	5 1/2"
4462-060	6"



1"

PART NO.	LENGTH
4465-001	Close
4465-020	2"
4465-025	2 1/2"
4465-030	3"
4465-035	3 1/2"
4465-040	4"
4465-045	4 1/2"
4465-050	5"
4465-055	5 1/2"
4465-060	6"

2"

PART NO.	LENGTH
4468-001	Close
4468-025	2 1/2"
4468-030	3"
4468-035	3 1/2"
4468-040	4"
4468-045	4 1/2"
4468-050	5"
4468-055	5 1/2"
4468-060	6"

PVC PIPE NIPPLES

• Can be used in both Schedule 40 and Schedule 80 pipe

• Pipe threads comply with ANSI B1.20.1



PART NO.	SIZE	INNER	MASTER
3403-001	1/2" x CLOSE	10	500
3403-015	1/2" x 11/2"	10	500
3403-020	1/2" x 2"	10	500
3403-025	1/2" x 2 1/2"	10	500
3403-030	1/2" x 3"	10	250
3403-040	1/2" x 4"	10	250
3403-060	1/2" x 6"	10	250
3403-080	1/2" x 8"	10	250
3403-100	1/2" x 10"	10	250
3403-120	1/2" x 12"	10	250
3403-180	1/2" x 18"	1	50
3403-240	1/2" x 24"	1	50
3404-001	3/4" x CLOSE	10	250
3404-020	3/4" x 2"	10	250
3404-025	3/4" x 2 1/2"	10	250
3404-030	3/4" x 3"	10	250
3404-040	3/4" x 4"	10	250
3404-060	3/4" x 6"	10	120
3404-080	3/4" x 8"	10	120
3404-100	3/4" x 10"	10	120
3404-120	3/4" x 12"	10	120
3404-180	3/4" x 18"	1	25
3404-240	3/4" x 24"	1	25
3405-020	1" x 2"	10	250
3405-030	1" x 3"	10	250
3405-060	1" x 6"	10	250
3406-020	1 1/4" x 2"	10	250
3406-030	1 1/4" x 3"	10	250
3406-060	1 1/4" x 6"	10	120
3406-080	1 1/4" x 8"	10	40
3407-001	1 1/2" x CLOSE	10	250
3407-020	1 1/2" x 2"	10	250
3407-040	1 1/2" x 4"	10	120
3408-001	2" x CLOSE	10	250
3408-030	2" x 3"	10	120
3408-040	2" x 4"	10	120

Fittings & Nipples

BLACK MALLEABLE IRON PIPE FITTINGS

- Malleable iron
- Individually bar coded, packed in bin boxes
- Pipe threads comply with ANSI B1.20.1
- Made to ANSI/ASTM A-197



90° Elbows

PART NO.	SIZE	BAG	INNER	MASTER
5520-000	1/8"	5	25	450
5520-001	1/4"	5	25	450
5520-002	3/8"	5	25	225
5520-003	1/2"	5	75	150
5520-004	3/4"	5	50	100
5520-005	1"	5	15	60
5520-006	1 1/4"	4	8	64
5520-007	1 1/2"	5	10	40
5520-008	2"	4	8	32

90° Reducing Elbows

PART NO.	SIZE	BAG	INNER	MASTER
5520-132	1/2" x 3/8"	5	25	225
5520-143	3/4" x 1/2"	5	15	135
5520-144	1" x 1/2"	5	15	120
5520-154	1" x 3/4"	5	15	120

45° Elbows

PART NO.	SIZE	BAG	INNER	MASTER
5520-200	1/8"	5	25	450
5520-201	1/4"	5	25	450
5520-202	3/8"	5	25	450
5520-203	1/2"	5	10	180
5520-204	3/4"	5	10	180
5520-205	1"		5	90
5520-206	1 1/4"		5	45
5520-207	1 1/2"		5	40
5520-208	2"	4	8	32

90° Street Elbows

PART NO.	SIZE	BAG	INNER	MASTER
5520-300	1/8"	5	25	450
5520-301	1/4"	5	25	450
5520-302	3/8"	5	10	180
5520-303	1/2"	5	45	180
5520-304	3/4"	5	25	100
5520-305	1"	5	15	120
5520-306	1 1/4"	4	8	64
5520-307	1 1/2"	5	10	40
5520-308	2"	4	8	32

45° Street Elbows

PART NO.	SIZE	BAG	INNER	MASTER
5520-503	1/2"	5	25	225

Bull Head Tees

PART NO.	SIZE	BAG	INNER	MASTER
5520-334	1/2" x 1/2" x 3/4"	5	45	90

Reducing Tees

PART NO.	SIZE	BAG	INNER	MASTER
5520-433	3/4" x 1/2" x 1/2"	5	45	90
5520-434	3/4" x 1/2" x 3/4"	5	45	90
5520-445	3/4" x 1"	5	10	80
5520-743	3/4" x 1/2"	5	45	90
5520-753	1" x 1/2"	5	10	80
5520-754	1" x 3/4"	5	10	80
5520-544	1" x 3/4" x 3/4"	5	10	80

Tees

PART NO.	SIZE	BAG	INNER	MASTER
5520-600	1/8"	5	25	450
5520-601	1/4"	5	25	450
5520-602	3/8"	5	20	180
5520-603	1/2"	5	50	200
5520-604	3/4"	5	30	120
5520-605	1"	5	10	80
5520-606	1 1/4"		5	40
5520-607	1 1/2"		5	40
5520-608	2"	3	6	24

Couplings

PART NO.	SIZE	BAG	INNER	MASTER
5521-200	1/8"	5	25	450
5521-201	1/4"	5	25	450
5521-202	3/8"	5	25	450
5521-203	1/2"	5	80	320
5521-204	3/4"	5	10	180
5521-205	1"	5	20	80
5521-206	1 1/4"	5	15	60
5521-207	1 1/2"	3	12	48
5521-208	2"		4	32

Fittings & Nipples

BLACK MALLEABLE IRON PIPE FITTINGS

- Malleable iron
- Individually bar coded, packed in bin boxes
- Pipe threads comply with ANSI B1.20.1
- Made to ANSI/ASTM A-197

Reducing Couplings

PART NO.	SIZE	BAG	INNER	MASTER
5521-310	1/4" x 1/8"	5	25	450
5521-321	3/8" x 1/4"	5	30	540
5521-332	1/2" x 3/8"	5	30	270
5521-342	3/4" x 3/8"	5	20	180
5521-343	3/4" x 1/2"	5	40	160
5521-353	1" x 1/2"	5	10	180
5521-354	1" x 3/4"	5	30	120
5521-365	1 1/4" x 1"		5	90
5521-376	1 1/2" x 1 1/4"		4	72

Plugs

PART NO.	SIZE	BAG	INNER	MASTER
5521-800	1/8"	5	25	450
5521-801	1/4"	5	25	450
5521-802	3/8"	5	25	450
5521-803	1/2"	5	50	450
5521-804	3/4"	5	40	360
5521-805	1"	5	20	180
5521-806	1 1/4"	5	10	180
5521-807	1 1/2"	4	12	108
5521-808	2"	4	8	72

Caps

PART NO.	SIZE	BAG	INNER	MASTER
5521-400	1/8"	5	25	450
5521-401	1/4"	5	25	450
5521-402	3/8"	5	35	630
5521-403	1/2"	5	75	300
5521-404	3/4"	5	40	320
5521-405	1"	5	25	200
5521-406	1 1/4"	4	8	144
5521-407	1 1/2"	5	15	120
5521-408	2"	3	6	54

Hex Bushings

PART NO.	SIZE	BAG	INNER	MASTER
5521-910	1/4" x 1/8"	5	35	630
5521-920	3/8" x 1/8"	5	35	630
5521-921	3/8" x 1/4"	5	35	630
5521-930	1/2" x 1/8"	5	30	540
5521-931	1/2" x 1/4"	5	30	540
5521-932	1/2" x 3/8"	5	40	720
5521-940	3/4" x 1/8"	5	50	300
5521-941	3/4" x 1/4"	5	75	300
5521-942	3/4" x 3/8"	5	75	300
5521-943	3/4" x 1/2"	5	75	300
5521-951	1" x 1/4"	5	25	225
5521-952	1" x 3/8"	5	25	225
5521-953	1" x 1/2"	5		225
5521-954	1" x 3/4"	5		225
5521-963	1 1/4" x 1/2"	4	12	108
5521-964	1 1/4" x 3/4"	4	12	108
5521-965	1 1/4" x 1"	4	12	216
5521-973	1 1/2" x 1/2"	5	10	90
5521-974	1 1/2" x 3/4"	5	10	90
5521-975	1 1/2" x 1"	5	10	90
5521-976	1 1/2" x 1 1/4"	5	10	180
5521-983	2" x 1/2"		5	45
5521-984	2" x 3/4"		5	45
5521-985	2" x 1"		5	45
5521-986	2" x 1 1/4"		5	45
5521-987	2" x 1 1/2"		5	90

Floor Flanges

PART NO.	SIZE	BAG	INNER	MASTER
5521-603	1/2"	5	20	160
5521-604	3/4"	5	20	80
5521-605	1"	5	15	60
5521-606	1 1/4"	4	12	48
5521-607	1 1/2"	5	10	40
5521-608	2"	3	12	24

Unions

PART NO.	SIZE	BAG	INNER	MASTER
5521-702	3/8"	5	35	140
5521-703	1/2"	5	30	120
5521-704	3/4"	5	35	70
5521-705	1"		5	40
5521-706	1 1/4"	4	8	32
5521-707	1 1/2"		4	32
5521-708	2"		4	16



Fittings & Nipples

STEEL PIPE NIPPLES BLACK

• Individually bar coded, packed in bin boxes

• Pipe threads comply with ANSI B1.20.1



1/8"

PART NO.	SIZE	BAG	INNER	MASTER
5580-001	1/8" x Close	5	10	480
5580-015	1/8" x 1 1/2"	5	10	480
5580-020	1/8" x 2"	5	10	480
5580-025	1/8" x 2 1/2"	5	10	480
5580-030	1/8" x 3"	5	10	480
5580-035	1/8" x 3 1/2"	5	10	240
5580-040	1/8" x 4"	5	10	240
5580-060	1/8" x 6"	5	10	240

1/4"

PART NO.	SIZE	BAG	INNER	MASTER
5581-001	1/4" x Close	5	10	480
5581-015	1/4" x 1 1/2"	5	10	480
5581-020	1/4" x 2"	5	10	480
5581-025	1/4" x 2 1/2"	5	10	480
5581-030	1/4" x 3"	5	10	480
5581-035	1/4" x 3 1/2"	5	10	240
5581-040	1/4" x 4"	5	10	240
5581-050	1/4" x 5"	5	10	240
5581-060	1/4" x 6"	5	10	240

3/8"

PART NO.	SIZE	BAG	INNER	MASTER
5582-001	3/8" x Close	5	10	480
5582-015	3/8" x 1 1/2"	5	10	480
5582-020	3/8" x 2"	5	10	480
5582-025	3/8" x 2 1/2"	5	10	480
5582-030	3/8" x 3"	5	10	480
5582-035	3/8" x 3 1/2"	5	10	240
5582-040	3/8" x 4"	5	10	240
5582-050	3/8" x 5"	5	10	240
5582-060	3/8" x 6"	5	10	160
5582-240	3/8" x 24"			5

1/2"

PART NO.	SIZE	BAG	INNER	MASTER
5583-001	1/2" x Close	5	25	600
5583-015	1/2" x 1 1/2"	5	25	600
5583-020	1/2" x 2"	5	25	400
5583-025	1/2" x 2 1/2"	5	25	400
5583-030	1/2" x 3"	5	25	200
5583-035	1/2" x 3 1/2"	5	25	200
5583-040	1/2" x 4"	5	25	150
5583-045	1/2" x 4 1/2"	5	25	150
5583-050	1/2" x 5"	5	25	200
5583-055	1/2" x 5 1/2"	5	25	100
5583-060	1/2" x 6"	5	25	100
5583-080	1/2" x 8"	5	25	75
5583-100	1/2" x 10"	5	25	75
5583-120	1/2" x 12"	5	25	75
5583-180	1/2" x 18"			5
5583-240	1/2" x 24"			5
5583-300	1/2" x 30"			5
5583-360	1/2" x 36"			5
5583-480	1/2" x 48"			5
5583-600	1/2" x 60"			5
5583-720	1/2" x 72"			5
5583-910	1/2" x 10 FT			5

3/4"

PART NO.	SIZE	BAG	INNER	MASTER
5584-001	3/4" x Close	5	25	400
5584-015	3/4" x 1 1/2"	5	25	400
5584-020	3/4" x 2"	5	25	300
5584-025	3/4" x 2 1/2"	5	25	300
5584-030	3/4" x 3"	5	25	200
5584-035	3/4" x 3 1/2"	5	25	200
5584-040	3/4" x 4"	5	25	200
5584-045	3/4" x 4 1/2"	5	25	100
5584-050	3/4" x 5"	5	25	100
5584-055	3/4" x 5 1/2"	5	25	100
5584-060	3/4" x 6"	5	25	100
5584-080	3/4" x 8"	5	25	50
5584-100	3/4" x 10"	5	25	50
5584-120	3/4" x 12"	5	25	50
5584-180	3/4" x 18"			5
5584-240	3/4" x 24"			5
5584-300	3/4" x 30"			5
5584-360	3/4" x 36"			5
5584-480	3/4" x 48"			5
5584-600	3/4" x 60"			5
5584-720	3/4" x 72"			5
5584-910	3/4" x 10 FT			5

Fittings & Nipples

STEEL PIPE NIPPLES BLACK

• Individually bar coded, packed in bin boxes

• Pipe threads comply with ANSI B1.20.1



1"

PART NO.	SIZE	BAG	INNER	MASTER
5585-001	1" x Close	5	10	160
5585-020	1" x 2"	5	10	160
5585-025	1" x 2 1/2"	5	10	160
5585-030	1" x 3"	5	10	160
5585-035	1" x 3 1/2"	5	10	160
5585-040	1" x 4"	5	10	120
5585-045	1" x 4 1/2"	5	10	120
5585-050	1" x 5"	5	10	80
5585-055	1" x 5 1/2"	5	10	80
5585-060	1" x 6"	5	10	80
5585-080	1" x 8"	5	10	40
5585-100	1" x 10"	5	10	40
5585-120	1" x 12"	5	10	40
5585-180	1" x 18"			3
5585-240	1" x 24"			3
5585-300	1" x 30"			3
5585-360	1" x 36"			3
5585-480	1" x 48"			3
5585-600	1" x 60"			3
5585-720	1" x 72"			3
5585-910	1" x 10 FT			3

1 1/4"

PART NO.	SIZE	INNER	MASTER
5586-001	1 1/4" x Close	5	80
5586-020	1 1/4" x 2"	5	80
5586-025	1 1/4" x 2 1/2"	5	80
5586-030	1 1/4" x 3"	5	80
5586-035	1 1/4" x 3 1/2"	5	60
5586-040	1 1/4" x 4"	5	60
5586-045	1 1/4" x 4 1/2"	5	60
5586-050	1 1/4" x 5"	5	60
5586-055	1 1/4" x 5 1/2"	5	60
5586-060	1 1/4" x 6"	5	60
5586-120	1 1/4" x 12"	5	30
5586-180	1 1/4" x 18"		3
5586-240	1 1/4" x 24"		3
5586-300	1 1/4" x 30"		3
5586-360	1 1/4" x 36"		3
5586-480	1 1/4" x 48"		3
5586-600	1 1/4" x 60"		3
5586-720	1 1/4" x 72"		3
5586-910	1 1/4" x 10 FT		3

1 1/2"

PART NO.	SIZE	INNER	MASTER
5587-001	1 1/2" x Close	5	80
5587-020	1 1/2" x 2"	5	80
5587-025	1 1/2" x 2 1/2"	5	80
5587-030	1 1/2" x 3"	5	80
5587-035	1 1/2" x 3 1/2"	5	60
5587-040	1 1/2" x 4"	5	60
5587-050	1 1/2" x 5"	5	20
5587-060	1 1/2" x 6"	5	20
5587-080	1 1/2" x 8"	5	20
5587-100	1 1/2" x 10"	5	20
5587-120	1 1/2" x 12"	5	20
5587-240	1 1/2" x 24"		3
5587-360	1 1/2" x 36"		3
5587-910	1 1/2" x 10 FT		3

2"

PART NO.	SIZE	INNER	MASTER
5588-001	2" x Close	5	40
5588-025	2" x 2 1/2"	5	40
5588-030	2" x 3"	5	40
5588-040	2" x 4"	5	30
5588-050	2" x 5"	5	20
5588-060	2" x 6"	5	20
5588-120	2" x 12"	5	10
5588-180	2" x 18"		3
5588-240	2" x 24"		3
5588-300	2" x 30"		3
5588-360	2" x 36"		3
5588-480	2" x 48"		3
5588-600	2" x 60"		3
5588-720	2" x 72"		3
5588-910	2" x 10 FT		3

Fittings & Nipples

GALVANIZED MALLEABLE IRON PIPE FITTINGS

- Malleable iron
- Individually bar coded, packed in bin boxes
- Pipe threads comply with ANSI B1.20.1
- Made to ANSI/ASTM A-197

90° Elbows

PART NO.	SIZE	BAG	INNER	MASTER
5510-000	1/8"	5	25	450
5510-001	1/4"	5	25	450
5510-002	3/8"	5	25	225
5510-003	1/2"	5	75	150
5510-004	3/4"	5	50	100
5510-005	1"	5	15	60
5510-006	1 1/4"	4	8	64
5510-007	1 1/2"	5	10	40
5510-008	2"	4	8	32

90° Reducing Elbows

PART NO.	SIZE	BAG	INNER	MASTER
5510-121	3/8" x 1/4"	5	25	450
5510-132	1/2" x 3/8"	5	25	225
5510-142	3/4" x 3/8"	5	15	135
5510-143	3/4" x 1/2"	5	15	135
5510-144	1" x 1/2"	5	15	120
5510-154	1" x 3/4"	5	15	120
5510-165	1 1/4" x 1"	4	8	64
5510-187	2" x 1 1/2"	4	8	32

45° Elbows

PART NO.	SIZE	BAG	INNER	MASTER
5510-200	1/8"	5	25	450
5510-201	1/4"	5	25	450
5510-202	3/8"	5	25	450
5510-203	1/2"	5	10	180
5510-204	3/4"	5	10	180
5510-205	1"		5	90
5510-206	1 1/4"		5	45
5510-207	1 1/2"		5	40
5510-208	2"	4	8	32

90° Street Elbows

PART NO.	SIZE	BAG	INNER	MASTER
5510-300	1/8"	5	25	450
5510-301	1/4"	5	25	450
5510-302	3/8"	5	10	180
5510-303	1/2"	5	45	180
5510-304	3/4"	5	25	100
5510-305	1"	5	15	120
5510-306	1 1/4"	4	8	64
5510-307	1 1/2"	5	10	40
5510-308	2"	4	8	32

Tees

PART NO.	SIZE	BAG	INNER	MASTER
5510-600	1/8"	5	25	450
5510-601	1/4"	5	25	450
5510-602	3/8"	5	20	180
5510-603	1/2"	5	50	200
5510-604	3/4"	5	30	120
5510-605	1"	5	10	80
5510-606	1 1/4"		5	40
5510-607	1 1/2"		5	40
5510-608	2"	3	6	24

Reducing Tees

PART NO.	SIZE	BAG	INNER	MASTER
5510-743	3/4" x 1/2"	5	45	90
5510-753	1" x 1/2"	5	10	80
5510-754	1" x 3/4"	5	10	80
5510-765	1 1/4" x 1"		5	40

Cross

PART NO.	SIZE	BAG	INNER	MASTER
5511-003	1/2"	5	45	90

Couplings

PART NO.	SIZE	BAG	INNER	MASTER
5511-200	1/8"	5	25	450
5511-201	1/4"	5	25	450
5511-202	3/8"	5	25	450
5511-203	1/2"	5	80	320
5511-204	3/4"	5	10	180
5511-205	1"	5	20	80
5511-206	1 1/4"	5	15	60
5511-207	1 1/2"	3	12	48
5511-208	2"		4	32



Fittings & Nipples

GALVANIZED MALLEABLE IRON PIPE FITTINGS

- Malleable iron
- Individually bar coded, packed in bin boxes
- Pipe threads comply with ANSI B1.20.1
- Made to ANSI/ASTM A-197

Reducing Couplings

PART NO.	SIZE	BAG	INNER	MASTER
5511-310	1/4" x 1/8"	5	25	450
5511-320	3/8" x 1/8"	5	30	540
5511-321	3/8" x 1/4"	5	30	540
5511-330	1/2" x 1/8"	5	30	540
5511-331	1/2" x 1/4"	5	30	270
5511-332	1/2" x 3/8"	5	30	270
5511-341	3/4" x 1/4"	5	20	180
5511-342	3/4" x 3/8"	5	20	180
5511-343	3/4" x 1/2"	5	40	160
5511-352	1" x 3/8"	5	10	180
5511-353	1" x 1/2"	5	10	180
5511-354	1" x 3/4"	5	30	120
5511-363	1 1/4" x 1/2"		5	90
5511-364	1 1/4" x 3/4"		5	90
5511-365	1 1/4" x 1"		5	90
5511-373	1 1/2" x 1/2"		4	72
5511-374	1 1/2" x 3/4"		4	72
5511-375	1 1/2" x 1"		4	72
5511-376	1 1/2" x 1 1/4"		4	72
5511-383	2" x 1/2"		5	40
5511-384	2" x 3/4"		5	40
5511-385	2" x 1"		5	40
5511-386	2" x 1 1/4"		5	40
5511-387	2" x 1 1/2"		5	40

Caps

PART NO.	SIZE	BAG	INNER	MASTER
5511-400	1/8"	5	25	450
5511-401	1/4"	5	25	450
5511-402	3/8"	5	35	630
5511-403	1/2"	5	75	300
5511-404	3/4"	5	40	320
5511-405	1"	5	25	200
5511-406	1 1/4"	4	8	144
5511-407	1 1/2"	5	15	120
5511-408	2"	3	6	54

Floor Flanges

PART NO.	SIZE	BAG	INNER	MASTER
5511-602	3/8"	5	20	160
5511-603	1/2"	5	20	160
5511-604	3/4"	5	20	80
5511-605	1"	5	15	60
5511-606	1 1/4"	5	10	40
5511-607	1 1/2"	5	10	40
5511-608	2"	3	12	48

Unions

PART NO.	SIZE	BAG	INNER	MASTER
5511-700	1/8"	5	35	280
5511-701	1/4"	5	45	180
5511-702	3/8"	5	35	140
5511-703	1/2"	5	30	120
5511-704	3/4"	5	35	70
5511-705	1"		5	40
5511-706	1 1/4"	4	8	32
5511-707	1 1/2"		4	32
5511-708	2"		4	16

Plugs

PART NO.	SIZE	BAG	INNER	MASTER
5511-800	1/8"	5	25	450
5511-801	1/4"	5	25	450
5511-802	3/8"	5	25	450
5511-803	1/2"	5	50	450
5511-804	3/4"	5	40	360
5511-805	1"	5	20	180
5511-806	1 1/4"	5	10	180
5511-807	1 1/2"	4	12	108
5511-808	2"	4	8	72

Hex Bushings

PART NO.	SIZE	BAG	INNER	MASTER
5511-910	1/4" x 1/8"	5	35	630
5511-920	3/8" x 1/8"	5	35	630
5511-921	3/8" x 1/4"	5	35	630
5511-930	1/2" x 1/8"	5	30	540
5511-931	1/2" x 1/4"	5	40	720
5511-932	1/2" x 3/8"	5	40	720
5511-940	3/4" x 1/8"	5	75	300
5511-941	3/4" x 1/4"	5	75	300
5511-942	3/4" x 3/8"	5	75	300
5511-943	3/4" x 1/2"	5	75	300
5511-951	1" x 1/4"	5	25	225
5511-952	1" x 3/8"	5	25	225
5511-953	1" x 1/2"	5		225
5511-954	1" x 3/4"	5		225
5511-961	1 1/4" x 1/4"	4	12	216
5511-962	1 1/4" x 3/8"	4	12	216
5511-963	1 1/4" x 1/2"	4	12	108
5511-964	1 1/4" x 3/4"	4	12	108
5511-965	1 1/4" x 1"	4	12	216
5511-973	1 1/2" x 1/2"	5	10	90
5511-974	1 1/2" x 3/4"	5	10	90
5511-975	1 1/2" x 1"	5	10	90
5511-976	1 1/2" x 1 1/4"	5	10	180
5511-983	2" x 1/2"		5	45
5511-984	2" x 3/4"		5	45
5511-985	2" x 1"		5	45
5511-986	2" x 1 1/4"		5	45
5511-987	2" x 1 1/2"		5	90
5511-998	2 1/2" x 2"	5	15	60



Fittings & Nipples

STEEL PIPE NIPPLES GALVANIZED

- Individually bar coded, packed in bin boxes
- Pipe threads comply with ANSI B1.20.1



1/8"

PART NO.	SIZE	BAG	INNER	MASTER
5560-001	1/8" x Close	5	10	480
5560-015	1/8" x 1 1/2"	5	10	480
5560-020	1/8" x 2"	5	10	480
5560-025	1/8" x 2 1/2"	5	10	480
5560-030	1/8" x 3"	5	10	480
5560-035	1/8" x 3 1/2"	5	10	240
5560-040	1/8" x 4"	5	10	240
5560-050	1/8" x 5"	5	10	240
5560-055	1/8" x 5 1/2"	5	10	240
5560-060	1/8" x 6"	5	10	240

1/4"

PART NO.	SIZE	BAG	INNER	MASTER
5561-001	1/4" x Close	5	10	480
5561-015	1/4" x 1 1/2"	5	10	480
5561-020	1/4" x 2"	5	10	480
5561-025	1/4" x 2 1/2"	5	10	480
5561-030	1/4" x 3"	5	10	480
5561-035	1/4" x 3 1/2"	5	10	240
5561-040	1/4" x 4"	5	10	240
5561-045	1/4" x 4 1/2"	5	10	240
5561-050	1/4" x 5"	5	10	240
5561-060	1/4" x 6"	5	10	240

3/8"

PART NO.	SIZE	BAG	INNER	MASTER
5562-001	3/8" x Close	5	10	480
5562-015	3/8" x 1 1/2"	5	10	480
5562-020	3/8" x 2"	5	10	480
5562-025	3/8" x 2 1/2"	5	10	480
5562-030	3/8" x 3"	5	10	480
5562-035	3/8" x 3 1/2"	5	10	240
5562-040	3/8" x 4"	5	10	240
5562-045	3/8" x 4 1/2"	5	10	240
5562-050	3/8" x 5"	5	10	240
5562-060	3/8" x 6"	5	10	160
5562-120	3/8" x 12"	5	25	75
5562-180	3/8" x 18"			5

1/2"

PART NO.	SIZE	BAG	INNER	MASTER
5563-001	1/2" x Close	5	25	600
5563-015	1/2" x 1 1/2"	5	25	600
5563-020	1/2" x 2"	5	25	400
5563-025	1/2" x 2 1/2"	5	25	400
5563-030	1/2" x 3"	5	25	200
5563-035	1/2" x 3 1/2"	5	25	200
5563-040	1/2" x 4"	5	25	150
5563-045	1/2" x 4 1/2"	5	25	150
5563-050	1/2" x 5"	5	25	200
5563-055	1/2" x 5 1/2"	5	25	100
5563-060	1/2" x 6"	5	25	100
5563-080	1/2" x 8"	5	25	75
5563-100	1/2" x 10"	5	25	75
5563-120	1/2" x 12"	5	25	75
5563-180	1/2" x 18"			5
5563-240	1/2" x 24"			5
5563-300	1/2" x 30"			5
5563-360	1/2" x 36"			5
5563-480	1/2" x 48"			5
5563-600	1/2" x 60"			5
5563-720	1/2" x 72"			5
5563-129	1/2" x 10 FT			5

3/4"

PART NO.	SIZE	BAG	INNER	MASTER
5564-001	3/4" x Close	5	25	400
5564-015	3/4" x 1 1/2"	5	25	400
5564-020	3/4" x 2"	5	25	300
5564-025	3/4" x 2 1/2"	5	25	300
5564-030	3/4" x 3"	5	25	200
5564-035	3/4" x 3 1/2"	5	25	200
5564-040	3/4" x 4"	5	25	200
5564-045	3/4" x 4 1/2"	5	25	100
5564-050	3/4" x 5"	5	25	100
5564-055	3/4" x 5 1/2"	5	25	100
5564-060	3/4" x 6"	5	25	100
5564-080	3/4" x 8"	5	25	50
5564-100	3/4" x 10"	5	25	50
5564-120	3/4" x 12"	5	25	50
5564-180	3/4" x 18"			5
5564-240	3/4" x 24"			5
5564-300	3/4" x 30"			5
5564-360	3/4" x 36"			5
5564-480	3/4" x 48"			5
5564-600	3/4" x 60"			5
5564-720	3/4" x 72"			5
5564-129	3/4" x 10FT			5

Fittings & Nipples

STEEL PIPE NIPPLES GALVANIZED

- Individually bar coded, packed in bin boxes
- Pipe threads comply with ANSI B1.20.1



1"

PART NO.	SIZE	BAG	INNER	MASTER
5565-001	1" x Close	5	10	160
5565-020	1" x 2"	5	10	160
5565-025	1" x 2 1/2"	5	10	160
5565-030	1" x 3"	5	10	160
5565-035	1" x 3 1/2"	5	10	160
5565-040	1" x 4"	5	10	120
5565-045	1" x 4 1/2"	5	10	120
5565-050	1" x 5"	5	10	80
5565-055	1" x 5 1/2"	5	10	80
5565-060	1" x 6"	5	10	80
5565-080	1" x 8"	5	10	40
5565-100	1" x 10"	5	10	40
5565-120	1" x 12"	5	10	40
5565-180	1" x 18"			3
5565-240	1" x 24"			3
5565-300	1" x 30"			3
5565-360	1" x 36"			3
5565-480	1" x 48"			3
5565-600	1" x 60"			3
5565-720	1" x 72"			3
5565-910	1" x 10FT			3

1 1/4"

PART NO.	SIZE	INNER	MASTER
5566-001	1 1/4" x Close	5	80
5566-020	1 1/4" x 2"	5	80
5566-025	1 1/4" x 2 1/2"	5	80
5566-030	1 1/4" x 3"	5	80
5566-035	1 1/4" x 3 1/2"	5	60
5566-040	1 1/4" x 4"	5	60
5566-045	1 1/4" x 4 1/2"	5	60
5566-050	1 1/4" x 5"	5	60
5566-055	1 1/4" x 5 1/2"	5	60
5566-060	1 1/4" x 6"	5	60
5566-080	1 1/4" x 8"	5	30
5566-100	1 1/4" x 10"	5	30
5566-120	1 1/4" x 12"	5	30
5566-180	1 1/4" x 18"		3
5566-240	1 1/4" x 24"		3
5566-300	1 1/4" x 30"		3
5566-360	1 1/4" x 36"		3
5566-480	1 1/4" x 48"		3
5566-600	1 1/4" x 60"		3
5566-720	1 1/4" x 72"		3
5566-910	1 1/4" x 10FT		3

1 1/2"

PART NO.	SIZE	INNER	MASTER
5567-001	1 1/2" x Close	5	80
5567-020	1 1/2" x 2"	5	80
5567-025	1 1/2" x 2 1/2"	5	80
5567-030	1 1/2" x 3"	5	80
5567-035	1 1/2" x 3 1/2"	5	60
5567-040	1 1/2" x 4"	5	60
5567-045	1 1/2" x 4 1/2"	5	20
5567-050	1 1/2" x 5"	5	20
5567-055	1 1/2" x 5 1/2"	5	20
5567-060	1 1/2" x 6"	5	20
5567-180	1 1/2" x 18"		3
5567-240	1 1/2" x 24"		3
5567-300	1 1/2" x 30"		3
5567-360	1 1/2" x 36"		3
5567-480	1 1/2" x 48"		3
5567-910	1 1/2" x 10FT		3

2"

PART NO.	SIZE	INNER	MASTER
5568-001	2" x Close	5	40
5568-025	2" x 2 1/2"	5	40
5568-030	2" x 3"	5	40
5568-035	2" x 3 1/2"	5	30
5568-040	2" x 4"	5	30
5568-045	2" x 4 1/2"	5	20
5568-050	2" x 5"	5	20
5568-055	2" x 5 1/2"	5	20
5568-060	2" x 6"	5	20
5568-910	2" x 10FT		3



PIPE MERCHANT COUPLINGS - GALVANIZED STEEL

PART NO.	SIZE	INNER	MASTER
5353-000	1/8"	270	540
5353-001	1/4"	270	540
5353-002	3/8"	225	450
5353-003	1/2"	200	400
5353-004	3/4"	160	320
5353-005	1"	80	160
5353-006	1 1/4"	32	64
5353-007	1 1/2"	24	48
5353-008	2"	18	36



NEW

INSERT FITTINGS - GALVANIZED STEEL

PART NO.	TYPE	SIZE	BAG	BOX	MASTER
5354-003	Male Insert Adapter	1/2"	5	50	200
5354-004	Male Insert Adapter	3/4"	5	50	200
5354-005	Male Insert Adapter	1"	5	25	100
5354-006	Male Insert Adapter	1 1/4"	5	25	50
5354-007	Male Insert Adapter	1 1/2"	5	25	50
5354-008	Male Insert Adapter	2"			25
5355-003	Insert Coupling	1/2"	5	50	200
5355-004	Insert Coupling	3/4"	5	50	200
5355-005	Insert Coupling	1"	5	25	100
5355-006	Insert Coupling	1 1/4"	5	25	50
5355-007	Insert Coupling	1 1/2"	5	25	50
5355-008	Insert Coupling	2"			25



Part Number Numerical Listing

1101-103.....	1-14	1107-603.....	1-5	1114-544.....	1-4	1197-394.....	1-2	1491-801.....	1-15
1101-104.....	1-14	1107-604.....	1-5	1116-503.....	1-4	1197-395.....	1-2	1491-802.....	1-15
1101-105.....	1-14	1107-605.....	1-5	1116-504.....	1-4	1197-443.....	1-3	1491-933.....	1-15
1101-106.....	1-14	1107-606.....	1-5	1190-003.....	1-6	1197-444.....	1-3	1590-003.....	1-13
1101-107.....	1-14	1107-607.....	1-5	1190-004.....	1-6	1197-503.....	1-1	1590-004.....	1-13
1101-108.....	1-14	1107-608.....	1-5	1190-005.....	1-6	1197-504.....	1-1	1590-005.....	1-13
1101-603.....	1-14	1107-633.....	1-5	1190-006.....	1-6	1197-505.....	1-1	1590-006.....	1-13
1101-604.....	1-14	1107-634.....	1-5	1190-007.....	1-6	1197-543.....	1-3	1590-007.....	1-13
1101-605.....	1-14	1107-635.....	1-5	1190-008.....	1-6	1197-544.....	1-3	1590-008.....	1-13
1101-606.....	1-14	1107-636.....	1-5	1190-503.....	1-6	1197-553.....	1-2	1903-190.....	2-9
1101-607.....	1-14	1107-637.....	1-5	1190-504.....	1-6	1197-554.....	1-2	1903-191.....	2-9
1101-608.....	1-14	1107-638.....	1-5	1190-505.....	1-6	1197-555.....	1-2	1903-194.....	2-9
1102-003.....	1-8	1107-639.....	1-5	1190-803.....	1-6	1197-643.....	1-3	1912-210.....	1-16
1102-004.....	1-8	1107-640.....	1-5	1190-804.....	1-6	1197-644.....	1-3	1912-212.....	1-16
1102-033.....	1-8	1107-821.....	1-4	1191-003.....	1-13	1197-743.....	1-3	1912-214.....	1-16
1102-043.....	1-7	1107-822.....	1-4	1191-004.....	1-13	1197-744.....	1-3	1912-215.....	1-16
1102-044.....	1-7	1107-823.....	1-4	1191-005.....	1-13	1197-745.....	1-3	1912-217.....	1-16
1102-053.....	1-8	1107-824.....	1-4	1191-006.....	1-13	1197-753.....	1-2	1912-219.....	1-16
1102-054.....	1-8	1107-825.....	1-4	1191-007.....	1-13	1197-754.....	1-2	1912-314.....	1-16
1102-063.....	1-8	1107-826.....	1-4	1191-008.....	1-13	1197-755.....	1-2	1912-319.....	1-16
1102-073.....	1-8	1107-827.....	1-4	1191-303.....	1-13	1197-803.....	1-2	1912-334.....	1-16
1102-207.....	1-9	1107-828.....	1-4	1191-304.....	1-13	1197-804.....	1-2	1912-339.....	1-16
1102-208.....	1-9	1107-829.....	1-4	1191-305.....	1-13	1197-903.....	1-2	1986-702.....	1-15
1102-353.....	1-7	1107-830.....	1-4	1191-306.....	1-13	1197-904.....	1-2	1988-102.....	1-16
1102-354.....	1-7	1107-831.....	1-4	1191-307.....	1-13	1197-905.....	1-2	1988-502.....	1-16
1102-453.....	1-7	1107-843.....	1-4	1191-308.....	1-13	1197-906.....	1-2	1988-602.....	1-16
1102-473.....	1-7	1107-844.....	1-4	1191-404.....	1-13	1197-907.....	1-2	1988-702.....	1-16
1102-653.....	1-8	1107-845.....	1-4	1191-405.....	1-13	1382-043.....	1-8	1989-102.....	1-16
1102-903.....	1-9	1107-846.....	1-4	1191-503.....	1-13	1382-044.....	1-8	1989-331.....	1-16
1102-993.....	1-9	1107-847.....	1-4	1191-504.....	1-13	1390-040.....	1-12	1989-332.....	1-16
1102-994.....	1-9	1107-848.....	1-4	1191-505.....	1-13	1390-060.....	1-12	1989-502.....	1-16
1103-003.....	1-9	1107-849.....	1-4	1195-003.....	1-6	1390-080.....	1-12	1989-551.....	1-16
1103-004.....	1-9	1107-850.....	1-4	1195-004.....	1-6	1390-100.....	1-12	1989-552.....	1-16
1103-053.....	1-9	1107-851.....	1-4	1195-103.....	1-6	1390-120.....	1-12	1989-602.....	1-16
1103-054.....	1-9	1107-923.....	1-1	1195-104.....	1-6	1390-140.....	1-12	1989-702.....	1-16
1104-551.....	1-11	1107-924.....	1-1	1195-503.....	1-6	1391-080.....	1-12	1990-102.....	1-15
1104-553.....	1-11	1107-925.....	1-1	1195-504.....	1-6	1391-100.....	1-12	1990-202.....	1-15
1104-555.....	1-11	1107-933.....	1-1	1195-513.....	1-7	1391-120.....	1-12	1990-302.....	1-15
1104-557.....	1-11	1107-934.....	1-1	1195-514.....	1-7	1392-040.....	1-11	1990-502.....	1-15
1104-559.....	1-11	1107-944.....	1-4	1195-543.....	1-7	1392-060.....	1-11	1990-601.....	1-15
1104-561.....	1-11	1107-945.....	1-4	1195-603.....	1-6	1392-080.....	1-11	1990-602.....	1-15
1104-711.....	1-11	1108-003.....	1-10	1195-604.....	1-6	1392-100.....	1-11	1991-102.....	1-15
1104-713.....	1-11	1108-004.....	1-10	1195-613.....	1-7	1392-120.....	1-11	1991-202.....	1-15
1104-715.....	1-11	1108-053.....	1-10	1195-614.....	1-7	1392-140.....	1-11	1991-302.....	1-15
1104-717.....	1-11	1108-054.....	1-10	1195-703.....	1-6	1393-080.....	1-11	1991-432.....	1-15
1104-719.....	1-11	1108-403.....	1-10	1195-704.....	1-6	1393-100.....	1-11	1991-502.....	1-15
1104-721.....	1-11	1108-503.....	1-10	1197-000.....	1-1	1393-120.....	1-11	1991-601.....	1-15
1107-103.....	1-5	1108-553.....	1-10	1197-001.....	1-1	1393-140.....	1-11	1991-602.....	1-15
1107-104.....	1-5	1108-653.....	1-10	1197-002.....	1-1	1394-080.....	1-11	1991-612.....	1-15
1107-105.....	1-5	1108-673.....	1-10	1197-003.....	1-1	1394-100.....	1-11	1991-622.....	1-15
1107-106.....	1-5	1108-904.....	1-10	1197-004.....	1-1	1394-120.....	1-11	1991-623.....	1-3
1107-107.....	1-5	1108-922.....	1-10	1197-005.....	1-1	1394-140.....	1-11	1991-624.....	1-3
1107-108.....	1-5	1108-993.....	1-10	1197-006.....	1-1	1395-080.....	1-12	1991-702.....	1-15
1107-133.....	1-5	1109-204.....	1-14	1197-007.....	1-1	1395-100.....	1-12	1991-712.....	1-15
1107-134.....	1-5	1109-224.....	1-14	1197-008.....	1-1	1395-120.....	1-12	1991-902.....	1-15
1107-135.....	1-5	1109-243.....	1-14	1197-023.....	1-1	1395-140.....	1-12	2122-219.....	2-4
1107-136.....	1-5	1109-303.....	1-14	1197-024.....	1-1	1395-503.....	1-7	2122-223.....	2-4
1107-137.....	1-5	1109-304.....	1-14	1197-025.....	1-1	1395-504.....	1-7	2122-275.....	2-4
1107-138.....	1-5	1109-503.....	1-14	1197-033.....	1-1	1395-603.....	1-7	2122-276.....	2-4
1107-203.....	1-5	1109-813.....	1-14	1197-034.....	1-1	1395-604.....	1-7	2122-277.....	2-4
1107-204.....	1-5	1109-814.....	1-14	1197-035.....	1-1	1396-100.....	1-12	2122-278.....	2-4
1107-205.....	1-5	1110-523.....	1-4	1197-343.....	1-2	1396-120.....	1-12	2122-281.....	2-4
1107-206.....	1-5	1110-524.....	1-4	1197-344.....	1-2	1396-140.....	1-12	2122-287.....	2-4
1107-207.....	1-5	1110-923.....	1-4	1197-345.....	1-2	1487-344.....	1-10	2122-288.....	2-4
1107-208.....	1-5	1110-924.....	1-4	1197-373.....	1-2	1490-801.....	1-15	2122-303.....	2-4
1107-233.....	1-5	1114-522.....	1-4	1197-374.....	1-2	1490-802.....	1-15	2123-003.....	2-10
1107-244.....	1-5	1114-523.....	1-4	1197-393.....	1-2	1490-933.....	1-15	2123-096.....	2-10



Part Number Numerical Listing

2125-005.....	2-8	3131-202.....	3-9	3164-103.....	3-19	3216-301.....	3-25	3250-006.....	3-21
2125-444.....	2-8	3131-301.....	3-9	3164-104.....	3-19	3217-101.....	3-15	3250-010.....	3-21
2125-503.....	2-8	3132-201.....	3-9	3164-105.....	3-19	3218-101.....	3-15	3250-012.....	3-21
2125-554.....	2-8	3133-101.....	3-10	3164-106.....	3-19	3218-901.....	3-15	3250-015.....	3-21
2125-888.....	2-8	3133-102.....	3-10	3164-107.....	3-19	3219-101.....	3-15	3250-195.....	3-21
2126-003.....	2-10	3133-103.....	3-10	3164-108.....	3-19	3219-301.....	3-15	3250-196.....	3-21
2126-005.....	2-10	3133-105.....	3-10	3164-603.....	3-19	3221-050.....	3-20	3250-198.....	3-21
2190-003.....	2-9	3133-107.....	3-10	3164-604.....	3-19	3221-103.....	4-8	3250-305.....	3-21
2190-004.....	2-8	3133-110.....	3-10	3164-605.....	3-19	3221-404.....	4-8	3250-412.....	3-21
2190-005.....	2-9	3133-111.....	3-10	3164-606.....	3-19	3221-704.....	4-8	3250-905.....	3-21
2190-006.....	2-9	3133-113.....	3-9	3164-607.....	3-19	3222-003.....	3-17	3250-906.....	3-21
2191-104.....	2-1	3133-114.....	3-9	3164-608.....	3-19	3222-500.....	3-17	3250-908.....	3-21
2191-604.....	2-2	3133-117.....	3-9	3167-004.....	3-17	3222-600.....	3-17	3250-912.....	3-21
2191-826.....	2-3	3133-202.....	3-9	3167-094.....	3-17	3224-120.....	3-3	3251-001.....	3-21
2191-829.....	2-1	3133-301.....	3-10	3168-003.....	3-17	3224-180.....	3-3	3251-002.....	3-21
2191-830.....	2-1	3133-404.....	3-10	3168-004.....	3-17	3224-240.....	3-3	3251-101.....	3-21
2192-108.....	2-5	3133-405.....	3-10	3168-005.....	3-17	3225-120.....	3-3	3251-305.....	3-21
2192-300.....	2-2	3133-901.....	3-10	3168-006.....	3-17	3226-033.....	3-3	3251-606.....	3-21
2192-304.....	2-2	3133-902.....	3-10	3168-007.....	3-17	3226-044.....	3-3	3260-120.....	3-3
2192-307.....	2-3	3133-903.....	3-10	3168-008.....	3-17	3227-120.....	3-2	3260-150.....	3-3
2192-311.....	2-3	3133-904.....	3-10	3168-094.....	3-17	3227-200.....	3-2	3260-180.....	3-3
2192-325.....	2-3	3134-101.....	3-12	3200-101.....	3-15	3228-120.....	3-2	3260-240.....	3-3
2192-330.....	2-1	3140-001.....	3-11	3200-201.....	3-15	3228-600.....	3-2	3265-100.....	3-14
2192-331.....	2-1	3140-002.....	3-11	3200-901.....	3-15	3229-180.....	3-3	3265-700.....	3-14
2192-336.....	2-3	3141-304.....	3-11	3203-480.....	3-16	3229-185.....	3-3	3270-001.....	3-22
2192-400.....	2-6	3141-305.....	3-11	3204-260.....	3-16	3229-212.....	3-3	3270-002.....	3-22
2192-402.....	2-6	3141-912.....	3-11	3205-101.....	3-12	3229-243.....	3-3	3270-102.....	3-22
2192-404.....	2-6	3142-090.....	3-11	3206-201.....	3-12	3229-244.....	3-3	3270-600.....	3-22
2192-407.....	2-6	3142-091.....	3-11	3206-501.....	3-12	3229-612.....	3-3	3270-720.....	3-22
2192-410.....	2-6	3142-092.....	3-11	3206-601.....	3-12	3229-643.....	3-3	3272-100.....	3-13
2192-417.....	2-5	3142-093.....	3-11	3206-901.....	3-12	3229-644.....	3-3	3273-100.....	3-14
2192-419.....	2-5	3142-094.....	3-11	3208-502.....	3-6	3230-090.....	3-2	3273-200.....	3-14
2192-424.....	2-5	3142-095.....	3-11	3208-503.....	3-6	3230-120.....	3-2	3273-300.....	3-14
2192-426.....	2-5	3142-096.....	3-11	3208-504.....	3-6	3230-160.....	3-2	3274-100.....	3-13
2192-430.....	2-7	3142-103.....	3-11	3208-505.....	3-6	3230-200.....	3-2	3275-100.....	2-10
2192-431.....	2-7	3152-005.....	3-13	3208-507.....	3-6	3230-300.....	3-2	3280-018.....	3-18
2192-432.....	2-7	3154-007.....	3-6	3208-508.....	3-6	3230-360.....	3-2	3280-024.....	3-18
2192-608.....	2-6	3154-008.....	3-6	3208-510.....	3-6	3231-060.....	3-2	3280-036.....	3-18
2192-750.....	2-3	3154-010.....	3-6	3208-511.....	3-6	3231-090.....	3-2	3280-048.....	3-18
2192-752.....	2-3	3154-011.....	3-6	3208-603.....	3-6	3231-120.....	3-2	3280-112.....	3-18
2192-796.....	2-5	3154-012.....	3-6	3208-604.....	3-6	3231-160.....	3-2	3280-118.....	3-18
2192-797.....	2-5	3154-013.....	3-6	3208-605.....	3-6	3231-200.....	3-2	3280-124.....	3-18
2193-009.....	2-9	3156-708.....	3-11	3208-901.....	3-6	3234-120.....	3-2	3280-136.....	3-18
2193-610.....	2-9	3156-712.....	3-11	3208-902.....	3-6	3234-200.....	3-2	3280-148.....	3-18
2381-210.....	2-7	3158-003.....	3-19	3208-903.....	3-6	3235-480.....	3-2	3282-001.....	3-18
2381-216.....	2-7	3158-004.....	3-19	3208-904.....	3-6	3235-600.....	3-2	3282-002.....	3-18
2399-100.....	2-8	3158-005.....	3-19	3208-906.....	3-6	3235-720.....	3-2	3282-003.....	3-18
2401-104.....	2-1	3158-006.....	3-19	3208-921.....	3-6	3235-960.....	3-2	3282-004.....	3-18
2401-604.....	2-2	3158-007.....	3-19	3209-258.....	3-8	3236-120.....	3-2	3291-112.....	3-3
2401-704.....	2-2	3158-008.....	3-19	3209-301.....	3-8	3236-160.....	3-2	3291-113.....	3-3
2401-705.....	2-2	3158-102.....	3-3	3209-302.....	3-8	3236-200.....	3-2	3291-114.....	3-3
2402-108.....	2-5	3158-103.....	3-3	3209-303.....	3-8	3236-300.....	3-2	3291-118.....	3-3
2402-208.....	2-6	3158-104.....	3-3	3209-304.....	3-8	3237-480.....	3-2	3291-119.....	3-3
3125-600.....	3-1	3158-503.....	3-19	3209-404.....	3-8	3237-600.....	3-2	3291-214.....	3-3
3125-605.....	3-1	3158-504.....	3-19	3209-406.....	3-8	3237-605.....	3-2	3291-219.....	3-3
3125-625.....	3-1	3158-505.....	3-19	3209-801.....	3-8	3237-720.....	3-2	3300-003.....	3-27
3125-630.....	3-1	3158-506.....	3-19	3209-901.....	3-8	3237-725.....	3-2	3300-004.....	3-27
3125-650.....	3-1	3158-507.....	3-19	3213-103.....	3-16	3238-600.....	3-2	3300-005.....	3-27
3125-660.....	3-1	3158-602.....	3-3	3213-480.....	3-16	3238-720.....	3-2	3301-003.....	3-27
3125-675.....	3-1	3158-603.....	3-3	3214-103.....	3-17	3238-999.....	3-2	3301-004.....	3-27
3125-700.....	3-1	3158-604.....	3-3	3214-104.....	3-17	3240-150.....	3-7	3301-501.....	3-27
3125-720.....	3-1	3158-866.....	3-19	3214-203.....	3-17	3240-200.....	3-7	3301-502.....	3-27
3125-775.....	3-1	3158-876.....	3-19	3214-204.....	3-17	3241-480.....	3-2	3303-003.....	3-27
3127-106.....	3-12	3158-877.....	3-19	3215-101.....	3-12	3241-600.....	3-2	3303-004.....	3-27
3129-003.....	3-15	3158-966.....	3-19	3215-909.....	3-12	3241-720.....	3-2	3303-005.....	3-27
3129-501.....	3-15	3158-976.....	3-19	3216-101.....	3-25	3250-004.....	3-21	3305-001.....	3-27
3131-201.....	3-8	3158-977.....	3-19	3216-201.....	3-25	3250-005.....	3-21	3305-002.....	3-27



Part Number Numerical Listing

3305-003.....	3-27	3406-020.....	4-19	3615-010.....	3-16	3630-002.....	3-5	4464-035.....	4-18
3305-004.....	3-27	3406-030.....	4-19	3615-025.....	3-16	3630-003.....	3-5	4464-040.....	4-18
3306-003.....	3-28	3406-060.....	4-19	3617-010.....	3-16	3630-501.....	3-5	4464-045.....	4-18
3307-001.....	3-28	3406-080.....	4-19	3617-025.....	3-16	3955-003.....	3-1	4464-050.....	4-18
3307-002.....	3-28	3407-001.....	4-19	3617-100.....	3-16	3955-033.....	3-1	4464-055.....	4-18
3308-001.....	3-28	3407-020.....	4-19	3618-003.....	4-8	3955-053.....	3-1	4464-060.....	4-18
3310-001.....	3-28	3407-040.....	4-19	3618-004.....	4-8	3955-142.....	3-1	4465-001.....	4-18
3311-008.....	3-25	3408-001.....	4-19	3618-005.....	4-8	3955-503.....	3-1	4465-020.....	4-18
3311-009.....	3-25	3408-030.....	4-19	3618-703.....	4-8	3993-001.....	3-18	4465-025.....	4-18
3314-001.....	3-28	3408-040.....	4-19	3618-704.....	4-8	3993-013.....	3-20	4465-030.....	4-18
3314-002.....	3-28	3475-001.....	3-22	3618-705.....	4-8	3993-113.....	3-20	4465-035.....	4-18
3314-003.....	3-28	3475-002.....	3-22	3619-001.....	3-6	3993-117.....	3-20	4465-040.....	4-18
3314-004.....	3-28	3475-003.....	3-22	3620-001.....	3-15	3993-904.....	3-18	4465-045.....	4-18
3315-003.....	3-28	3475-004.....	3-22	3620-002.....	3-15	3993-913.....	3-20	4465-050.....	4-18
3315-004.....	3-28	3476-001.....	3-22	3620-003.....	3-15	3993-915.....	3-18	4465-055.....	4-18
3317-800.....	3-28	3476-002.....	3-22	3620-005.....	3-15	3993-916.....	3-18	4465-060.....	4-18
3317-900.....	3-28	3476-003.....	3-22	3621-001.....	3-5	3994-001.....	3-22	4466-001.....	4-18
3319-002.....	3-27	3477-001.....	3-22	3621-002.....	3-5	3995-001.....	3-20	4466-020.....	4-18
3319-003.....	3-27	3485-007.....	3-7	3621-003.....	3-5	4460-001.....	4-18	4466-025.....	4-18
3319-004.....	3-27	3485-008.....	3-7	3621-004.....	3-5	4460-015.....	4-18	4466-030.....	4-18
3319-005.....	3-27	3485-010.....	3-7	3622-001.....	3-5	4460-020.....	4-18	4466-035.....	4-18
3360-026.....	3-26	3485-011.....	3-7	3622-002.....	3-5	4460-025.....	4-18	4466-040.....	4-18
3379-150.....	3-25	3490-010.....	3-7	3622-003.....	3-5	4460-030.....	4-18	4466-045.....	4-18
3379-200.....	3-25	3490-011.....	3-7	3623-001.....	3-5	4460-035.....	4-18	4466-050.....	4-18
3380-100.....	3-13	3490-508.....	3-7	3623-002.....	3-5	4460-040.....	4-18	4466-055.....	4-18
3386-080.....	3-13	3490-510.....	3-7	3623-003.....	3-5	4460-045.....	4-18	4466-060.....	4-18
3386-140.....	3-13	3490-511.....	3-7	3623-004.....	3-5	4460-050.....	4-18	4467-001.....	4-18
3386-500.....	3-13	3492-016.....	3-7	3624-001.....	3-5	4460-055.....	4-18	4467-020.....	4-18
3387-100.....	3-13	3492-116.....	3-7	3624-301.....	3-5	4460-060.....	4-18	4467-025.....	4-18
3387-500.....	3-13	3492-118.....	3-7	3624-501.....	3-5	4461-001.....	4-18	4467-030.....	4-18
3388-001.....	3-16	3492-216.....	3-7	3624-601.....	3-5	4461-015.....	4-18	4467-035.....	4-18
3388-002.....	3-16	3492-218.....	3-7	3624-701.....	3-5	4461-020.....	4-18	4467-040.....	4-18
3388-003.....	3-16	3492-316.....	3-7	3624-901.....	3-13	4461-025.....	4-18	4467-045.....	4-18
3388-004.....	3-16	3492-318.....	3-7	3625-001.....	3-4	4461-030.....	4-18	4467-050.....	4-18
3389-100.....	3-25	3493-007.....	3-7	3625-002.....	3-4	4461-035.....	4-18	4467-055.....	4-18
3397-400.....	3-16	3493-008.....	3-7	3625-003.....	3-4	4461-040.....	4-18	4467-060.....	4-18
3397-500.....	3-16	3493-010.....	3-7	3625-004.....	3-4	4461-045.....	4-18	4468-001.....	4-18
3398-100.....	3-9	3494-001.....	3-13	3625-005.....	3-4	4461-050.....	4-18	4468-025.....	4-18
3398-104.....	3-9	3495-010.....	3-10	3625-006.....	3-4	4461-055.....	4-18	4468-030.....	4-18
3398-500.....	3-9	3495-011.....	3-10	3625-007.....	3-4	4461-060.....	4-18	4468-035.....	4-18
3398-504.....	3-9	3496-010.....	3-10	3625-008.....	3-4	4462-001.....	4-18	4468-040.....	4-18
3403-001.....	4-19	3496-011.....	3-10	3625-009.....	3-4	4462-015.....	4-18	4468-045.....	4-18
3403-015.....	4-19	3497-007.....	3-11	3625-010.....	3-4	4462-020.....	4-18	4468-050.....	4-18
3403-020.....	4-19	3497-008.....	3-11	3625-011.....	3-4	4462-025.....	4-18	4468-055.....	4-18
3403-025.....	4-19	3513-001.....	3-24	3625-012.....	3-4	4462-030.....	4-18	4468-060.....	4-18
3403-030.....	4-19	3513-002.....	3-24	3625-013.....	3-4	4462-035.....	4-18	4490-000.....	4-16
3403-040.....	4-19	3514-001.....	3-24	3625-014.....	3-4	4462-040.....	4-18	4490-001.....	4-16
3403-060.....	4-19	3514-002.....	3-24	3625-015.....	3-4	4462-045.....	4-18	4490-002.....	4-16
3403-080.....	4-19	3546-001.....	3-14	3625-016.....	3-4	4462-050.....	4-18	4490-003.....	4-16
3403-100.....	4-19	3547-001.....	3-14	3625-017.....	3-4	4462-055.....	4-18	4490-004.....	4-16
3403-120.....	4-19	3547-002.....	3-14	3625-018.....	3-4	4462-060.....	4-18	4490-005.....	4-16
3403-180.....	4-19	3547-003.....	3-14	3625-019.....	3-4	4463-001.....	4-18	4490-006.....	4-16
3403-240.....	4-19	3558-001.....	3-14	3626-011.....	3-4	4463-015.....	4-18	4490-007.....	4-16
3404-001.....	4-19	3558-002.....	3-14	3626-016.....	3-4	4463-020.....	4-18	4490-008.....	4-16
3404-020.....	4-19	3561-003.....	3-25	3627-011.....	3-4	4463-025.....	4-18	4490-020.....	4-16
3404-025.....	4-19	3561-004.....	3-25	3627-014.....	3-4	4463-030.....	4-18	4490-021.....	4-16
3404-030.....	4-19	3566-004.....	3-25	3627-016.....	3-4	4463-035.....	4-18	4490-032.....	4-16
3404-040.....	4-19	3568-001.....	3-25	3628-010.....	3-4	4463-040.....	4-18	4490-043.....	4-16
3404-060.....	4-19	3576-010.....	3-17	3628-011.....	3-4	4463-045.....	4-18	4490-054.....	4-16
3404-080.....	4-19	3576-050.....	3-17	3628-014.....	3-4	4463-050.....	4-18	4491-000.....	4-16
3404-100.....	4-19	3576-950.....	3-17	3628-016.....	3-4	4463-055.....	4-18	4491-001.....	4-16
3404-120.....	4-19	3611-010.....	3-16	3628-018.....	3-4	4463-060.....	4-18	4491-002.....	4-16
3404-180.....	4-19	3611-025.....	3-16	3628-019.....	3-4	4464-001.....	4-18	4491-003.....	4-16
3404-240.....	4-19	3611-100.....	3-16	3628-021.....	3-4	4464-015.....	4-18	4491-004.....	4-16
3405-020.....	4-19	3613-010.....	3-16	3629-011.....	3-5	4464-020.....	4-18	4491-005.....	4-16
3405-030.....	4-19	3613-025.....	3-16	3629-016.....	3-5	4464-025.....	4-18	4491-006.....	4-16
3405-060.....	4-19	3613-100.....	3-16	3629-019.....	3-5	4464-030.....	4-18	4491-007.....	4-16

5521-801.....	4-21	5563-015.....	4-26	5566-030.....	4-27	5582-040.....	4-22	5585-720.....	4-23
5521-802.....	4-21	5563-020.....	4-26	5566-035.....	4-27	5582-050.....	4-22	5585-910.....	4-23
5521-803.....	4-21	5563-025.....	4-26	5566-040.....	4-27	5582-060.....	4-22	5586-001.....	4-23
5521-804.....	4-21	5563-030.....	4-26	5566-045.....	4-27	5582-240.....	4-22	5586-020.....	4-23
5521-805.....	4-21	5563-035.....	4-26	5566-050.....	4-27	5583-001.....	4-22	5586-025.....	4-23
5521-806.....	4-21	5563-040.....	4-26	5566-055.....	4-27	5583-015.....	4-22	5586-030.....	4-23
5521-807.....	4-21	5563-045.....	4-26	5566-060.....	4-27	5583-020.....	4-22	5586-035.....	4-23
5521-808.....	4-21	5563-050.....	4-26	5566-080.....	4-27	5583-025.....	4-22	5586-040.....	4-23
5521-910.....	4-21	5563-055.....	4-26	5566-100.....	4-27	5583-030.....	4-22	5586-045.....	4-23
5521-920.....	4-21	5563-060.....	4-26	5566-120.....	4-27	5583-035.....	4-22	5586-050.....	4-23
5521-921.....	4-21	5563-080.....	4-26	5566-180.....	4-27	5583-040.....	4-22	5586-055.....	4-23
5521-930.....	4-21	5563-100.....	4-26	5566-240.....	4-27	5583-045.....	4-22	5586-060.....	4-23
5521-931.....	4-21	5563-120.....	4-26	5566-300.....	4-27	5583-050.....	4-22	5586-120.....	4-23
5521-932.....	4-21	5563-129.....	4-26	5566-360.....	4-27	5583-055.....	4-22	5586-180.....	4-23
5521-940.....	4-21	5563-180.....	4-26	5566-480.....	4-27	5583-060.....	4-22	5586-240.....	4-23
5521-941.....	4-21	5563-240.....	4-26	5566-600.....	4-27	5583-080.....	4-22	5586-300.....	4-23
5521-942.....	4-21	5563-300.....	4-26	5566-720.....	4-27	5583-100.....	4-22	5586-360.....	4-23
5521-943.....	4-21	5563-360.....	4-26	5566-910.....	4-27	5583-120.....	4-22	5586-480.....	4-23
5521-951.....	4-21	5563-480.....	4-26	5567-001.....	4-27	5583-180.....	4-22	5586-600.....	4-23
5521-952.....	4-21	5563-600.....	4-26	5567-020.....	4-27	5583-240.....	4-22	5586-720.....	4-23
5521-953.....	4-21	5563-720.....	4-26	5567-025.....	4-27	5583-300.....	4-22	5586-910.....	4-23
5521-954.....	4-21	5564-001.....	4-26	5567-030.....	4-27	5583-360.....	4-22	5587-001.....	4-23
5521-963.....	4-21	5564-015.....	4-26	5567-035.....	4-27	5583-480.....	4-22	5587-020.....	4-23
5521-964.....	4-21	5564-020.....	4-26	5567-040.....	4-27	5583-600.....	4-22	5587-025.....	4-23
5521-965.....	4-21	5564-025.....	4-26	5567-045.....	4-27	5583-720.....	4-22	5587-030.....	4-23
5521-973.....	4-21	5564-030.....	4-26	5567-050.....	4-27	5583-910.....	4-22	5587-035.....	4-23
5521-974.....	4-21	5564-035.....	4-26	5567-055.....	4-27	5584-001.....	4-22	5587-040.....	4-23
5521-975.....	4-21	5564-040.....	4-26	5567-060.....	4-27	5584-015.....	4-22	5587-050.....	4-23
5521-976.....	4-21	5564-045.....	4-26	5567-180.....	4-27	5584-020.....	4-22	5587-060.....	4-23
5521-983.....	4-21	5564-050.....	4-26	5567-240.....	4-27	5584-025.....	4-22	5587-080.....	4-23
5521-984.....	4-21	5564-055.....	4-26	5567-300.....	4-27	5584-030.....	4-22	5587-100.....	4-23
5521-985.....	4-21	5564-060.....	4-26	5567-360.....	4-27	5584-035.....	4-22	5587-120.....	4-23
5521-986.....	4-21	5564-080.....	4-26	5567-480.....	4-27	5584-040.....	4-22	5587-240.....	4-23
5521-987.....	4-21	5564-100.....	4-26	5567-910.....	4-27	5584-045.....	4-22	5587-360.....	4-23
5560-001.....	4-26	5564-120.....	4-26	5568-001.....	4-27	5584-050.....	4-22	5587-910.....	4-23
5560-015.....	4-26	5564-129.....	4-26	5568-025.....	4-27	5584-055.....	4-22	5588-001.....	4-23
5560-020.....	4-26	5564-180.....	4-26	5568-030.....	4-27	5584-060.....	4-22	5588-025.....	4-23
5560-025.....	4-26	5564-240.....	4-26	5568-035.....	4-27	5584-080.....	4-22	5588-030.....	4-23
5560-030.....	4-26	5564-300.....	4-26	5568-040.....	4-27	5584-100.....	4-22	5588-040.....	4-23
5560-035.....	4-26	5564-360.....	4-26	5568-045.....	4-27	5584-120.....	4-22	5588-050.....	4-23
5560-040.....	4-26	5564-480.....	4-26	5568-050.....	4-27	5584-180.....	4-22	5588-060.....	4-23
5560-050.....	4-26	5564-600.....	4-26	5568-055.....	4-27	5584-240.....	4-22	5588-120.....	4-23
5560-055.....	4-26	5564-720.....	4-26	5568-060.....	4-27	5584-300.....	4-22	5588-180.....	4-23
5560-060.....	4-26	5565-001.....	4-27	5568-910.....	4-27	5584-360.....	4-22	5588-240.....	4-23
5561-001.....	4-26	5565-020.....	4-27	5580-001.....	4-22	5584-480.....	4-22	5588-300.....	4-23
5561-015.....	4-26	5565-025.....	4-27	5580-015.....	4-22	5584-600.....	4-22	5588-360.....	4-23
5561-020.....	4-26	5565-030.....	4-27	5580-020.....	4-22	5584-720.....	4-22	5588-480.....	4-23
5561-025.....	4-26	5565-035.....	4-27	5580-025.....	4-22	5584-910.....	4-22	5588-600.....	4-23
5561-030.....	4-26	5565-040.....	4-27	5580-030.....	4-22	5585-001.....	4-23	5588-720.....	4-23
5561-035.....	4-26	5565-045.....	4-27	5580-035.....	4-22	5585-020.....	4-23	5588-910.....	4-23
5561-040.....	4-26	5565-050.....	4-27	5580-040.....	4-22	5585-025.....	4-23	6340-001.....	3-29
5561-045.....	4-26	5565-055.....	4-27	5580-060.....	4-22	5585-030.....	4-23	6340-501.....	3-30
5561-050.....	4-26	5565-060.....	4-27	5581-001.....	4-22	5585-035.....	4-23	6340-502.....	3-30
5561-060.....	4-26	5565-080.....	4-27	5581-015.....	4-22	5585-040.....	4-23	6350-001.....	3-29
5562-001.....	4-26	5565-100.....	4-27	5581-020.....	4-22	5585-045.....	4-23	6350-002.....	3-29
5562-015.....	4-26	5565-120.....	4-27	5581-025.....	4-22	5585-050.....	4-23	6350-003.....	3-29
5562-020.....	4-26	5565-180.....	4-27	5581-030.....	4-22	5585-055.....	4-23	6350-004.....	3-29
5562-025.....	4-26	5565-240.....	4-27	5581-035.....	4-22	5585-060.....	4-23	6350-005.....	3-29
5562-030.....	4-26	5565-300.....	4-27	5581-040.....	4-22	5585-080.....	4-23	6350-006.....	3-29
5562-035.....	4-26	5565-360.....	4-27	5581-050.....	4-22	5585-100.....	4-23	6350-007.....	3-29
5562-040.....	4-26	5565-480.....	4-27	5581-060.....	4-22	5585-120.....	4-23	6350-008.....	3-29
5562-045.....	4-26	5565-600.....	4-27	5582-001.....	4-22	5585-180.....	4-23	6350-009.....	3-29
5562-050.....	4-26	5565-720.....	4-27	5582-015.....	4-22	5585-240.....	4-23	6350-010.....	3-29
5562-060.....	4-26	5565-910.....	4-27	5582-020.....	4-22	5585-300.....	4-23	6350-011.....	3-29
5562-120.....	4-26	5566-001.....	4-27	5582-025.....	4-22	5585-360.....	4-23	6350-012.....	3-30
5562-180.....	4-26	5566-020.....	4-27	5582-030.....	4-22	5585-480.....	4-23	6350-013.....	3-30
5563-001.....	4-26	5566-025.....	4-27	5582-035.....	4-22	5585-600.....	4-23	6350-014.....	3-30

6350-015.....	3-29	7575-010.....	3-26	9003-001.....	4-11	9007-903.....	4-12	9277-044.....	4-3
6350-018.....	3-30	7575-011.....	3-26	9003-002.....	4-11	9008-003.....	4-12	9277-055.....	4-3
6350-019.....	3-30	7575-012.....	3-26	9003-003.....	4-11	9008-004.....	4-12	9277-633.....	4-3
6350-020.....	3-29	7575-013.....	3-26	9003-004.....	4-11	9008-005.....	4-12	9277-733.....	4-3
6350-021.....	3-30	7575-014.....	3-26	9003-005.....	4-11	9050-006.....	4-13	9277-734.....	4-3
6350-201.....	3-29	7575-015.....	3-26	9003-006.....	4-11	9050-007.....	4-13	9277-833.....	4-6
6350-590.....	3-30	7575-017.....	3-26	9003-007.....	4-11	9050-008.....	4-13	9277-844.....	4-6
6350-888.....	3-29	7575-018.....	3-26	9003-032.....	4-11	9050-086.....	4-13	9277-933.....	4-3
6350-913.....	3-30	7575-019.....	3-26	9003-043.....	4-11	9052-007.....	4-13	9278-333.....	4-3
6350-999.....	3-29	7575-020.....	3-26	9003-076.....	4-11	9052-008.....	4-13	9278-334.....	4-3
6351-002.....	3-30	7575-021.....	3-26	9003-503.....	4-11	9053-006.....	4-13	9278-433.....	4-3
6351-501.....	3-30	7575-022.....	3-26	9003-504.....	4-11	9053-007.....	4-13	9278-434.....	4-3
6351-502.....	3-30	7575-023.....	3-26	9003-505.....	4-11	9053-008.....	4-13	9278-443.....	4-3
6351-503.....	3-30	7575-024.....	3-26	9003-506.....	4-11	9053-503.....	4-13	9278-444.....	4-3
6351-504.....	3-30	7575-025.....	3-26	9003-507.....	4-11	9054-006.....	4-13	9278-535.....	4-3
6351-505.....	3-30	7575-026.....	3-26	9003-704.....	4-11	9054-007.....	4-13	9278-544.....	4-3
6351-506.....	3-30	7575-027.....	3-26	9003-803.....	4-11	9054-507.....	4-13	9278-545.....	4-3
6351-507.....	3-30	7575-030.....	3-26	9003-903.....	4-11	9055-076.....	4-13	9278-553.....	4-3
6351-508.....	3-30	7575-031.....	3-26	9004-003.....	4-11	9055-086.....	4-13	9278-554.....	4-3
6351-509.....	3-30	7575-032.....	3-26	9004-004.....	4-11	9055-087.....	4-13	9278-555.....	4-3
6351-510.....	3-30	7575-033.....	3-26	9004-005.....	4-11	9057-006.....	4-13	9278-833.....	4-6
6351-511.....	3-30	7575-034.....	3-26	9004-006.....	4-11	9057-007.....	4-13	9278-844.....	4-6
6351-512.....	3-30	7575-035.....	3-26	9004-007.....	4-11	9057-008.....	4-13	9279-003.....	4-3
6351-513.....	3-30	9000-001.....	4-10	9004-503.....	4-11	9059-006.....	4-13	9279-004.....	4-3
6351-901.....	3-30	9000-002.....	4-10	9004-504.....	4-11	9059-007.....	4-13	9279-005.....	4-3
7500-001.....	3-23	9000-003.....	4-10	9004-505.....	4-11	9059-008.....	4-13	9279-803.....	4-6
7500-003.....	3-23	9000-004.....	4-10	9004-704.....	4-11	9151-006.....	4-13	9279-804.....	4-6
7500-010.....	3-23	9000-005.....	4-10	9004-803.....	4-11	9151-007.....	4-13	9281-033.....	4-3
7501-000.....	3-23	9000-006.....	4-10	9004-903.....	4-11	9151-008.....	4-13	9281-034.....	4-3
7501-001.....	3-23	9000-007.....	4-10	9005-031.....	4-11	9152-006.....	4-13	9281-043.....	4-3
7501-005.....	3-23	9000-021.....	4-10	9005-032.....	4-11	9159-006.....	4-13	9281-044.....	4-3
7501-006.....	3-23	9000-031.....	4-10	9005-043.....	4-11	9159-007.....	4-13	9281-054.....	4-3
7503-001.....	3-26	9000-032.....	4-10	9005-054.....	4-11	9159-008.....	4-13	9281-055.....	4-3
7503-002.....	3-26	9000-043.....	4-10	9005-063.....	4-11	9250-003.....	4-4	9281-903.....	4-3
7503-003.....	3-26	9000-054.....	4-10	9005-075.....	4-11	9250-004.....	4-4	9281-904.....	4-3
7507-001.....	3-23	9000-065.....	4-10	9005-076.....	4-11	9250-005.....	4-4	9281-905.....	4-3
7507-003.....	3-23	9000-704.....	4-10	9005-553.....	4-11	9250-043.....	4-4	9281-934.....	4-3
7507-004.....	3-23	9000-803.....	4-10	9006-001.....	4-12	9251-003.....	4-4	9281-943.....	4-3
7507-005.....	3-23	9000-903.....	4-10	9006-002.....	4-12	9251-004.....	4-4	9282-032.....	4-7
7509-001.....	3-23	9001-003.....	4-10	9006-003.....	4-12	9251-005.....	4-4	9282-132.....	4-7
7509-003.....	3-23	9001-004.....	4-10	9006-004.....	4-12	9252-333.....	4-4	9282-237.....	4-7
7510-001.....	3-23	9001-005.....	4-10	9006-005.....	4-12	9252-433.....	4-4	9283-033.....	4-4
7512-001.....	3-24	9001-007.....	4-10	9006-006.....	4-12	9252-434.....	4-4	9283-034.....	4-4
7515-001.....	3-23	9001-031.....	4-10	9006-007.....	4-12	9252-443.....	4-4	9283-043.....	4-4
7516-001.....	3-24	9001-032.....	4-10	9006-334.....	4-12	9252-444.....	4-4	9283-044.....	4-4
7516-002.....	3-24	9001-034.....	4-10	9006-433.....	4-12	9252-553.....	4-4	9283-055.....	4-4
7516-003.....	3-24	9001-035.....	4-10	9006-434.....	4-12	9252-554.....	4-4	9283-603.....	4-4
7516-503.....	3-24	9001-043.....	4-10	9006-443.....	4-12	9252-555.....	4-4	9283-603.....	4-5
7517-001.....	3-24	9001-053.....	4-10	9006-533.....	4-12	9253-033.....	4-4	9283-604.....	4-4
7517-002.....	3-24	9001-054.....	4-10	9006-534.....	4-12	9253-034.....	4-4	9283-604.....	4-5
7517-003.....	3-24	9001-056.....	4-10	9006-535.....	4-12	9253-043.....	4-4	9283-703.....	4-4
7517-501.....	3-24	9001-057.....	4-10	9006-543.....	4-12	9253-044.....	4-4	9283-704.....	4-4
7519-001.....	3-24	9001-503.....	4-10	9006-544.....	4-12	9253-055.....	4-4	9283-803.....	4-4
7521-001.....	3-24	9001-504.....	4-10	9006-553.....	4-12	9254-033.....	4-4	9283-903.....	4-4
7521-002.....	3-24	9001-505.....	4-10	9006-554.....	4-12	9254-044.....	4-4	9283-904.....	4-4
7521-003.....	3-24	9002-003.....	4-10	9006-704.....	4-12	9255-003.....	4-4	9283-905.....	4-4
7521-004.....	3-24	9002-004.....	4-10	9006-803.....	4-12	9255-004.....	4-4	9284-003.....	4-7
7538-001.....	3-25	9002-005.....	4-10	9006-903.....	4-12	9255-005.....	4-4	9284-004.....	4-7
7575-001.....	3-26	9002-006.....	4-10	9007-003.....	4-12	9276-003.....	4-3	9284-005.....	4-7
7575-002.....	3-26	9002-007.....	4-10	9007-004.....	4-12	9276-004.....	4-3	9284-703.....	4-7
7575-003.....	3-26	9002-031.....	4-10	9007-005.....	4-12	9276-005.....	4-3	9284-704.....	4-7
7575-004.....	3-26	9002-032.....	4-10	9007-006.....	4-12	9276-043.....	4-3	9284-803.....	4-7
7575-005.....	3-26	9002-034.....	4-10	9007-007.....	4-12	9276-054.....	4-3	9284-804.....	4-7
7575-006.....	3-26	9002-043.....	4-10	9007-008.....	4-12	9276-803.....	4-6	9284-805.....	4-7
7575-007.....	3-26	9002-503.....	4-10	9007-503.....	4-12	9276-804.....	4-6	9285-100.....	4-9
7575-008.....	3-26	9002-504.....	4-10	9007-704.....	4-12	9277-033.....	4-3	9285-203.....	4-9
7575-009.....	3-26	9002-505.....	4-10	9007-803.....	4-12	9277-043.....	4-3	9285-204.....	4-9



Part Number Numerical Listing

9285-334.....	4-9	9492-205.....	4-1	9683-803.....	4-5
9285-400.....	4-9	9492-243.....	4-1	9683-903.....	4-5
9285-458.....	4-9	9492-254.....	4-1	9683-904.....	4-5
9285-500.....	4-9	9492-303.....	4-1	9684-503.....	4-7
9285-603.....	4-9	9492-304.....	4-1	9684-504.....	4-7
9285-604.....	4-9	9492-305.....	4-1	9689-503.....	4-7
9285-653.....	4-9	9492-403.....	4-1	9689-504.....	4-7
9285-654.....	4-9	9492-404.....	4-1	9750-003.....	4-6
9285-700.....	4-9	9492-405.....	4-1	9750-004.....	4-6
9285-903.....	4-9	9492-433.....	4-1	9750-043.....	4-6
9285-904.....	4-9	9492-434.....	4-1	9751-003.....	4-6
9285-905.....	4-9	9492-443.....	4-1	9751-004.....	4-6
9285-934.....	4-9	9492-454.....	4-1	9752-333.....	4-6
9285-953.....	4-9	9492-503.....	4-1	9752-433.....	4-6
9285-954.....	4-9	9492-504.....	4-1	9752-434.....	4-6
9285-983.....	4-9	9492-505.....	4-1	9752-443.....	4-6
9285-984.....	4-9	9492-534.....	4-1	9752-444.....	4-6
9286-100.....	4-9	9492-603.....	4-1	9753-033.....	4-6
9286-199.....	4-9	9492-604.....	4-1	9753-034.....	4-6
9286-200.....	4-9	9492-605.....	4-1	9753-043.....	4-6
9286-299.....	4-9	9492-634.....	4-1	9753-044.....	4-6
9286-300.....	4-9	9492-654.....	4-1	9754-033.....	4-6
9287-003.....	4-7	9492-703.....	4-1	9754-044.....	4-6
9287-004.....	4-7	9492-704.....	4-1	9755-003.....	4-6
9287-005.....	4-7	9492-803.....	4-1	9755-004.....	4-6
9287-903.....	4-7	9492-804.....	4-1	9900-004.....	4-15
9287-904.....	4-7	9492-903.....	4-1	9900-005.....	4-15
9288-110.....	4-8	9493-534.....	4-2	9900-054.....	4-15
9288-114.....	4-8	9493-544.....	4-2	9900-104.....	4-15
9288-116.....	4-8	9494-915.....	4-2	9900-105.....	4-15
9288-118.....	4-8	9494-916.....	4-2	9903-503.....	4-14
9288-214.....	4-8	9495-022.....	4-2	9903-504.....	4-14
9288-216.....	4-8	9495-032.....	4-2	9903-534.....	4-14
9289-003.....	4-7	9496-703.....	4-2	9903-703.....	4-14
9289-004.....	4-7	9496-803.....	4-2	9903-804.....	4-14
9289-005.....	4-7	9676-003.....	4-5	9903-903.....	4-14
9290-006.....	4-8	9676-004.....	4-5	9906-332.....	4-14
9290-008.....	4-8	9676-043.....	4-5	9906-443.....	4-14
9290-106.....	4-8	9677-033.....	4-5	9906-503.....	4-14
9290-108.....	4-8	9677-043.....	4-5	9906-504.....	4-14
9400-504.....	4-15	9677-044.....	4-5	9907-434.....	4-14
9400-505.....	4-15	9677-833.....	4-5	9907-443.....	4-14
9440-030.....	4-14	9677-933.....	4-5	9907-444.....	4-14
9443-101.....	4-15	9677-943.....	4-5	9908-404.....	4-14
9443-102.....	4-15	9678-333.....	4-5	9940-030.....	4-14
9443-251.....	4-15	9678-334.....	4-5	9972-003.....	4-14
9443-252.....	4-15	9678-433.....	4-5	9972-004.....	4-14
9443-255.....	4-15	9678-434.....	4-5	9972-103.....	4-14
9443-325.....	4-15	9678-443.....	4-5	9972-104.....	4-14
9443-355.....	4-15	9678-444.....	4-5	9972-131.....	4-14
9445-125.....	4-15	9679-003.....	4-5	9972-132.....	4-14
9445-150.....	4-15	9679-004.....	4-5	9972-134.....	4-14
9445-225.....	4-15	9681-033.....	4-5	9972-143.....	4-14
9445-250.....	4-15	9681-034.....	4-5	9972-203.....	4-14
9445-325.....	4-15	9681-043.....	4-5	9972-204.....	4-14
9445-350.....	4-15	9681-044.....	4-5	9972-231.....	4-14
9482-003.....	4-1	9681-903.....	4-5	9972-232.....	4-14
9482-004.....	4-1	9681-904.....	4-5	9972-234.....	4-14
9484-003.....	4-2	9681-934.....	4-5	9972-243.....	4-14
9484-004.....	4-2	9681-943.....	4-5		
9484-005.....	4-2	9683-033.....	4-5		
9492-003.....	4-1	9683-034.....	4-5		
9492-004.....	4-1	9683-043.....	4-5		
9492-005.....	4-1	9683-044.....	4-5		
9492-043.....	4-1	9683-703.....	4-5		
9492-203.....	4-1	9683-704.....	4-5		
9492-204.....	4-1	9683-753.....	4-5		

Terms and Conditions

Our catalogue contains product specifications of certain products sold by John L. Schultz Ltd. John L. Schultz Ltd. may, from time to time, discontinue, change or otherwise modify without notice any of the products listed herein. Possession of our catalogue or price sheets by any person is not to be construed as an offer to sell that person or anyone else the goods listed herein at the price stated. All prices subject to change without notice.

Terms of Payment

Net terms – 30 days from invoice date. A 1 1/2% service charge per month will be added to any past due balance.

Freight Policy

Freight charges will be prepaid on orders for \$1000.00 NET or more for shipment to one destination. Otherwise freight terms are collect, from our Dorval, Quebec warehouse.

Returned Goods

Merchandise may not be returned for credit unless the Seller has agreed to accept the return in writing. Where returns are accepted, a deduction of 20% or \$20.00, whichever is greater will be made for re-handling. All transportation costs for returned goods must be paid by the Buyer. In any event, only saleable merchandise of standard manufacture may be returned for credit.

Shortages or Variances

No claims for variances from or shortages in any order will be considered unless presented within 5 days after receipt of goods.

Minimum Order

An order for items included in our catalogue for which invoice prices aggregate less than \$100.00 net will be billed at \$100.00

Limited Warranty

If within one year from date of sale, any part that is proven defective by our inspection in material or workmanship, and has not been subjected to abusive treatment or faulty installation, will be replaced free of charge, but with no allowance for labor, other expenses or losses. This warranty and limit of liability are exclusive, no other warranty expressed or implied is made, nor any other responsibility, expressed or implied, assumed.

Damage

We take the greatest care in packing and shipping our merchandise and are not responsible for damage incurred after shipment has been delivered to the carrier. All claims should be made to the carrier for damaged or lost merchandise.

JOHN L. SCHULTZ LTD.
1723 55th Ave.
Dorval, Quebec
H9P 2W3