

Stretta Countertops – Installation Made Easy

With Stretta's patent-pending installation process, installing a countertop has never been faster or easier!

IMPORTANT INFORMATION ABOUT YOUR STRETTA COUNTERTOP

- **CAUTION:** The product is heavy and should be lifted by two people to avoid injury or damage during installation.
- For Indoor Installation Only
- To clean your Stretta countertop, use a mild dish soap and warm water applied with a soft cloth. Do not utilize abrasive cleaners or cleaning tools. Always test cleaning products in an inconspicuous area first.
- Your Stretta countertop is manufactured with 100% pre-consumer recycled cores and low-emitting, water-based adhesives.

INSTALLATION KIT CONTAINS:



4 Wood Biscuits



1 Bottle
Color-matched Adhesive



3 Specialty Screws



1 Specialty Screw Bit

TOOLS REQUIRED:

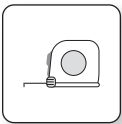

Measuring
Tape

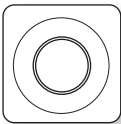

Masking
Tape



Pencil

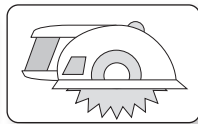

Circular
Saw



180 Grit
Sandpaper

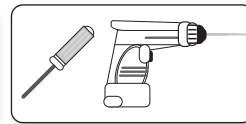

Multi-bit Screwdriver
or Drill

SAFETY:



Safety
Glasses



Dusk
Mask



Ear
Protection

STEP 1 - TEST FIT

Place Stretta countertop(s) on installed base cabinetry to test fit the tops and to determine if you need to modify the length of the countertop(s). Standard overhang for exposed ends is $\frac{1}{2}$ " (**Figure 1-1**) while those that meet a wall or appliance have no overhang and fit flush. Prior to cutting the countertop to length, apply masking tape to the cut line to ensure a smooth cut. Also, make sure the teeth of the saw enter the top surface of the countertop. (**Figure 1-2**)

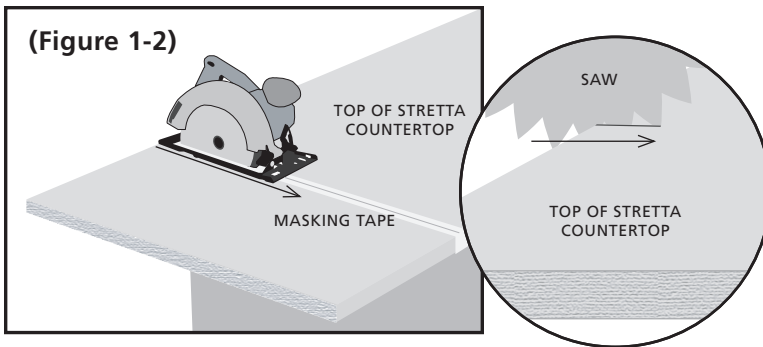
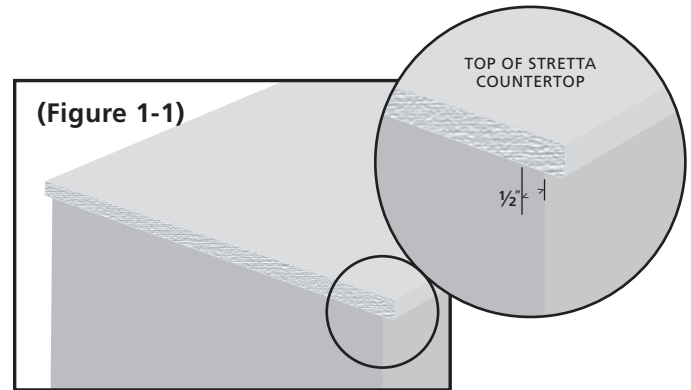

Before installing, test fit the Londoner[™] joint (**Figure 1-3**) to make sure it comes together tightly. If necessary, sand with 180 grit sandpaper to remove any rough or irregular areas of the substrate.

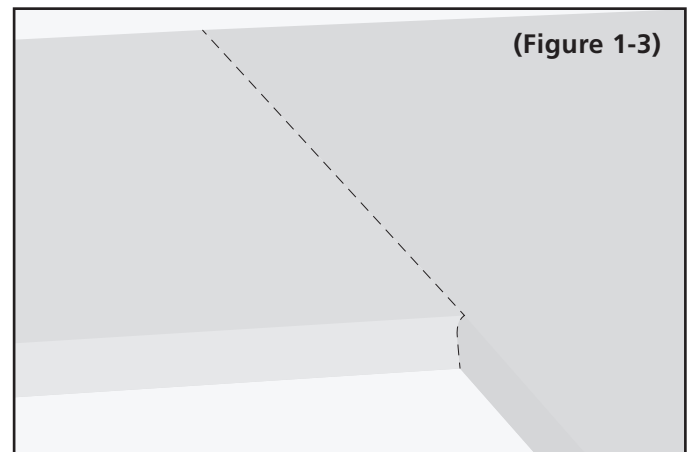

STEP 2 - JOIN COUNTERTOP

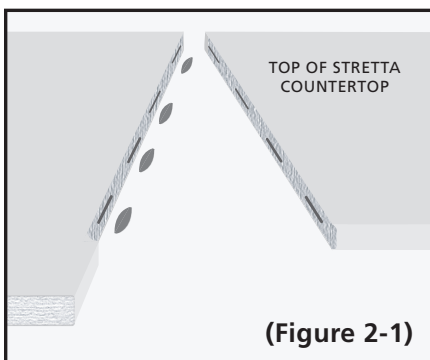

Install 4 biscuits into one side of the countertop. (**Figure 2-1**) Apply a generous amount of color-matched adhesive to both sides of the Londoner joint and the biscuits, so that when the countertops are joined together, the excess glue is squeezed out. Pull countertops together. (**Figure 2-2**) Allow the glue to cure for five minutes prior to removing the excess with warm water and a cotton cloth.

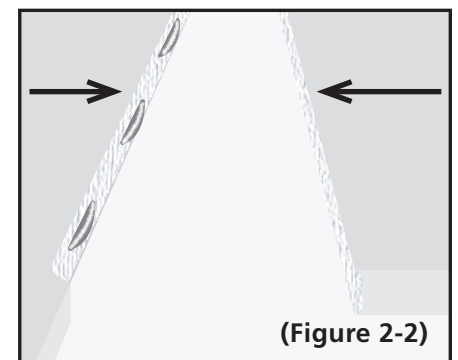

STEP 3 - SECURE COUNTERTOP

Slide the countertops away from the wall slightly to access the pockets on the underside of the countertop. Drive the three specialty screws into the pockets using the specialty screw bit included in the Stretta Installation Kit. Two screw pockets are located on the bottom side of the countertop (**Figure 3-1**) and one is located on the back side of the countertop. (**Figure 3-2**)

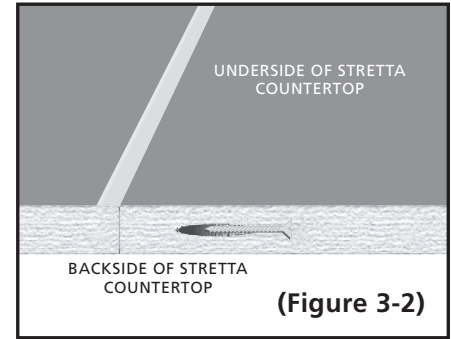
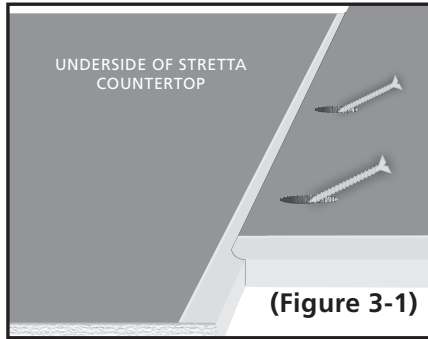

You can now attach your countertop to the cabinets by driving screws (not included) through the cabinet corner mounting brackets into the countertop. (**Figure 3-3**)

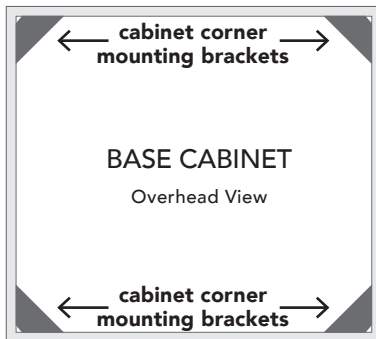

(Figure 3-3)

CAUTION: Do not use screws that exceed the combined thickness of the corner mounting bracket and the thickness of the Stretta countertop, otherwise you risk surface penetration. (Figure 3-4)

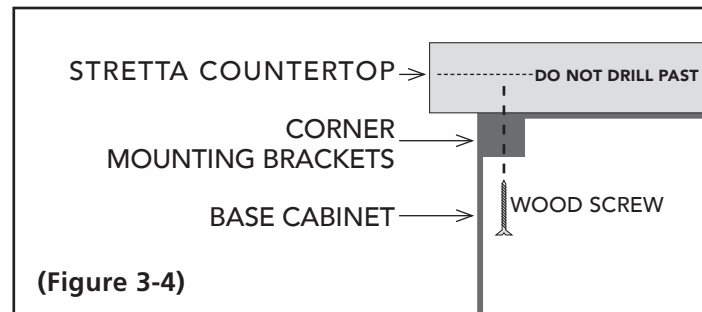

To finish the exposed ends of the countertop and backsplash, please see the easy-to-follow instructions included in the **Stretta Endcap Kit**.

Topes Stretta - Facilitando la instalación

Con el proceso de instalación con patente pendiente de Stretta, instalar un tope nunca ha sido más rápido ni fácil.

INFORMACIÓN IMPORTANTE SOBRE SU TOPE STRETTA

- **ADVERTENCIA:** El producto es pesado y debe ser levantado por dos personas para evitar lesiones o daños durante la instalación.
- Solo para la instalación en interiores.
- Para limpiar su tope Stretta, use un jabón lavaplatos suave y agua tibia aplicados con un paño suave. No utilice limpiadores abrasivos ni herramientas de limpieza. Pruebe siempre primero los productos de limpieza en un área poco visible.
- Su tope Stretta está fabricado 100% con núcleos reciclados preconsumo y adhesivos a base de agua de baja emisión.

EL KIT DE INSTALACIÓN CONTIENE LO SIGUIENTE:



4 galletas de madera



1 botella de adhesivo del color correspondiente



3 tornillos especiales



1 broca para tornillos especiales

HERRAMIENTAS REQUERIDAS:

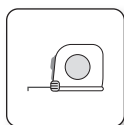

Cinta métrica



Cinta de enmascarar



Lápiz

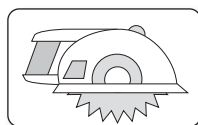

Sierra circular



Papel de lija de grano 180

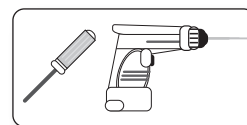

Destornillador o taladro multibroca

SEGURIDAD:



Gafas de seguridad



Mascarilla contra el polvo



Protección para los oídos

Ponga los topes Stretta sobre los muebles bajos instalados para hacer ajustes de prueba de los topes y determinar si usted tiene que modificar la longitud de los topes. El saliente estándar para los extremos expuestos es de 1/2" (Figura 1-1), mientras que aquellos que entren en contacto con una pared o un electrodoméstico no tienen un saliente y se ajustan al ras. Antes de cortar el tope a la medida, aplique cinta de enmascarar a la línea de corte para asegurar un corte uniforme. Además, asegúrese de que los dientes de la sierra corten la superficie superior del tope (Figura 1-2).

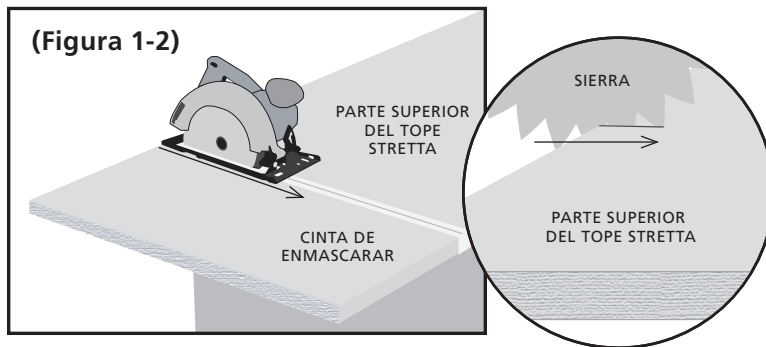
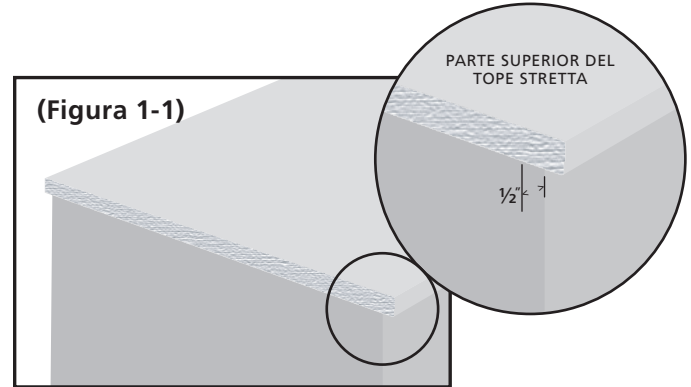

Antes de instalar, haga un ajuste de prueba de la junta Londoner[™] (Figura 1-3) para asegurarse de que se una bien. Si es necesario, lije con papel de lija de grano 180 para eliminar cualquier área áspera o irregular del sustrato

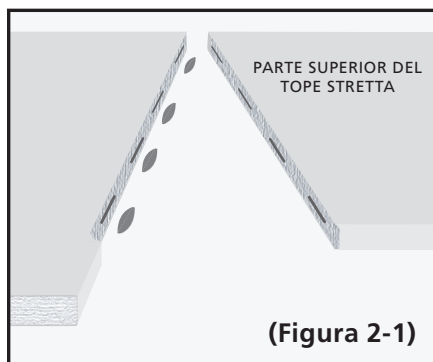
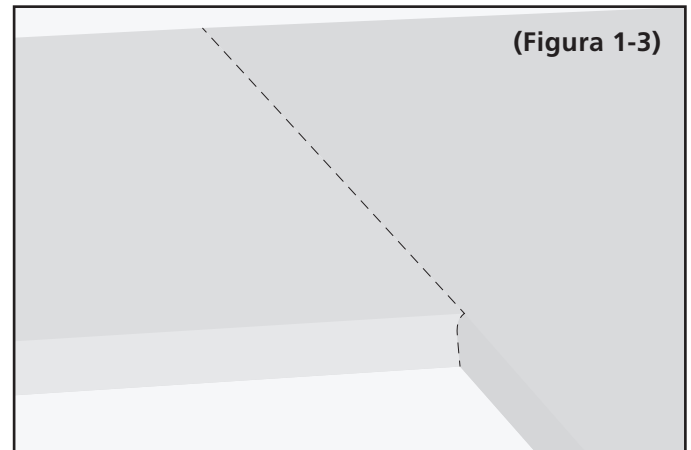

Instale 4 galletas en un lado del tope (Figura 2-1). Aplique una cantidad generosa de adhesivo del color correspondiente a ambos lados de la junta Londoner y las galletas, de modo que cuando los topes se unan, se exprima el exceso de adhesivo. Una los topes (Figura 2-2). Deje que el adhesivo se cure durante cinco minutos antes de eliminar el exceso con agua tibia y un paño de algodón.

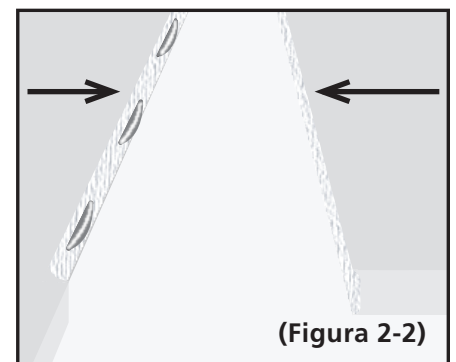

Separe ligeramente los topes de la pared para acceder a los huecos de la parte inferior del tope. Introduzca los tres tornillos especiales en los huecos con la broca para tornillos especiales incluida en el kit de instalación de Stretta. Dos de los huecos para tornillos se encuentran en el lado inferior del tope (**Figura 3-1**) y uno se encuentra en la parte posterior del tope (**Figura 3-2**).

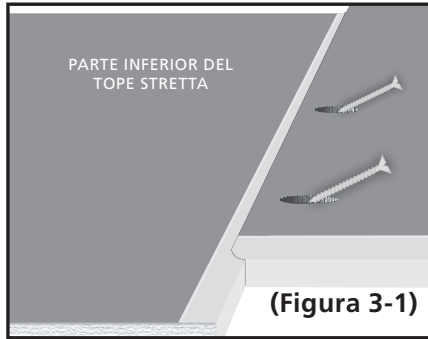

(Figura 3-1)

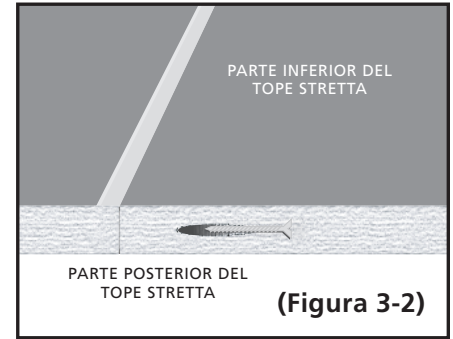

(Figura 3-2)

Usted puede fijar ahora su tope a los muebles introduciendo los tornillos (no incluidos) a través de los soportes de montaje de las esquinas del mueble en el tope (**Figura 3-3**).

ADVERTENCIA: No use tornillos que excedan del grosor combinado del soporte de montaje de una esquina y el tope Stretta, o de lo contrario usted corre el riesgo de penetrar en la superficie (**Figura 3-4**).

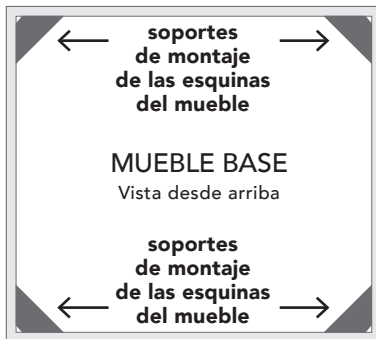

(Figura 3-3)

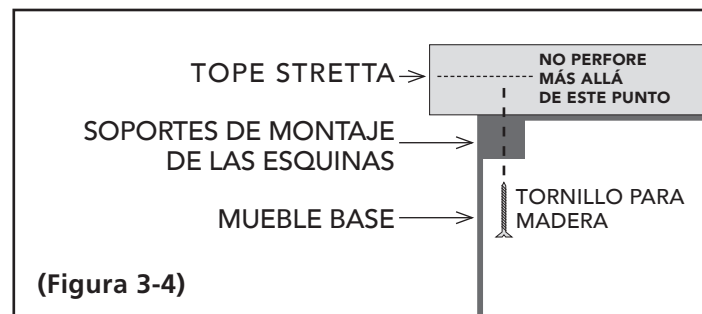

(Figura 3-4)

Para acabar los extremos expuestos del tope y el protector contra salpicaduras, por favor, consulte las instrucciones fáciles de seguir incluidas en el kit de tapas de Stretta.

Stretta[™]
from VT Industries

Para obtener información adicional sobre cómo instalar su tope Stretta, visite **strettacountertops.com**