

.25 DIA THRU

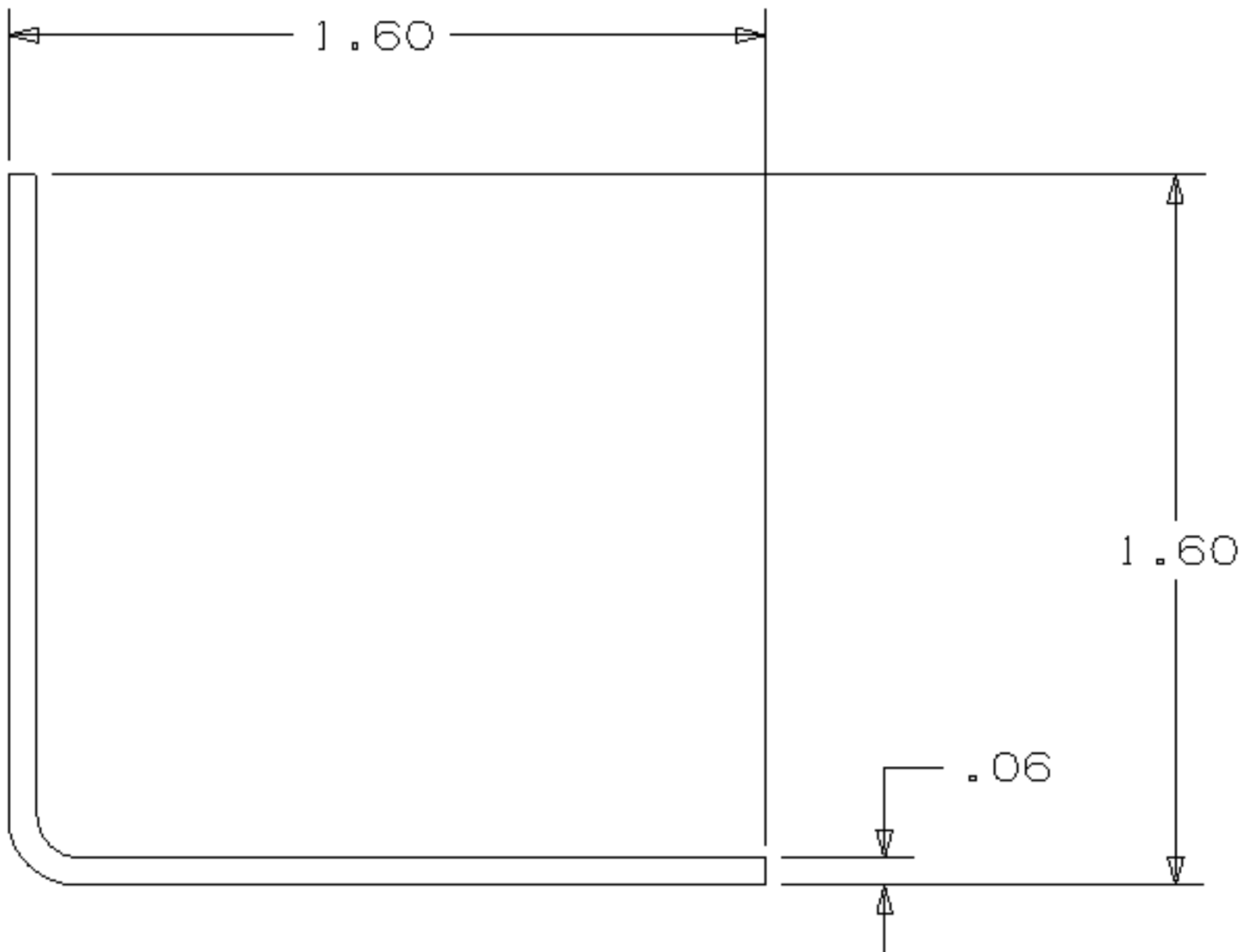

Dimensions shown are nominal and subject to change. For critical design specification, contact [techinfo@natman.com](mailto:techinfo@natman.com)  
©2000 National Manufacturing Co.