

.81 DIA

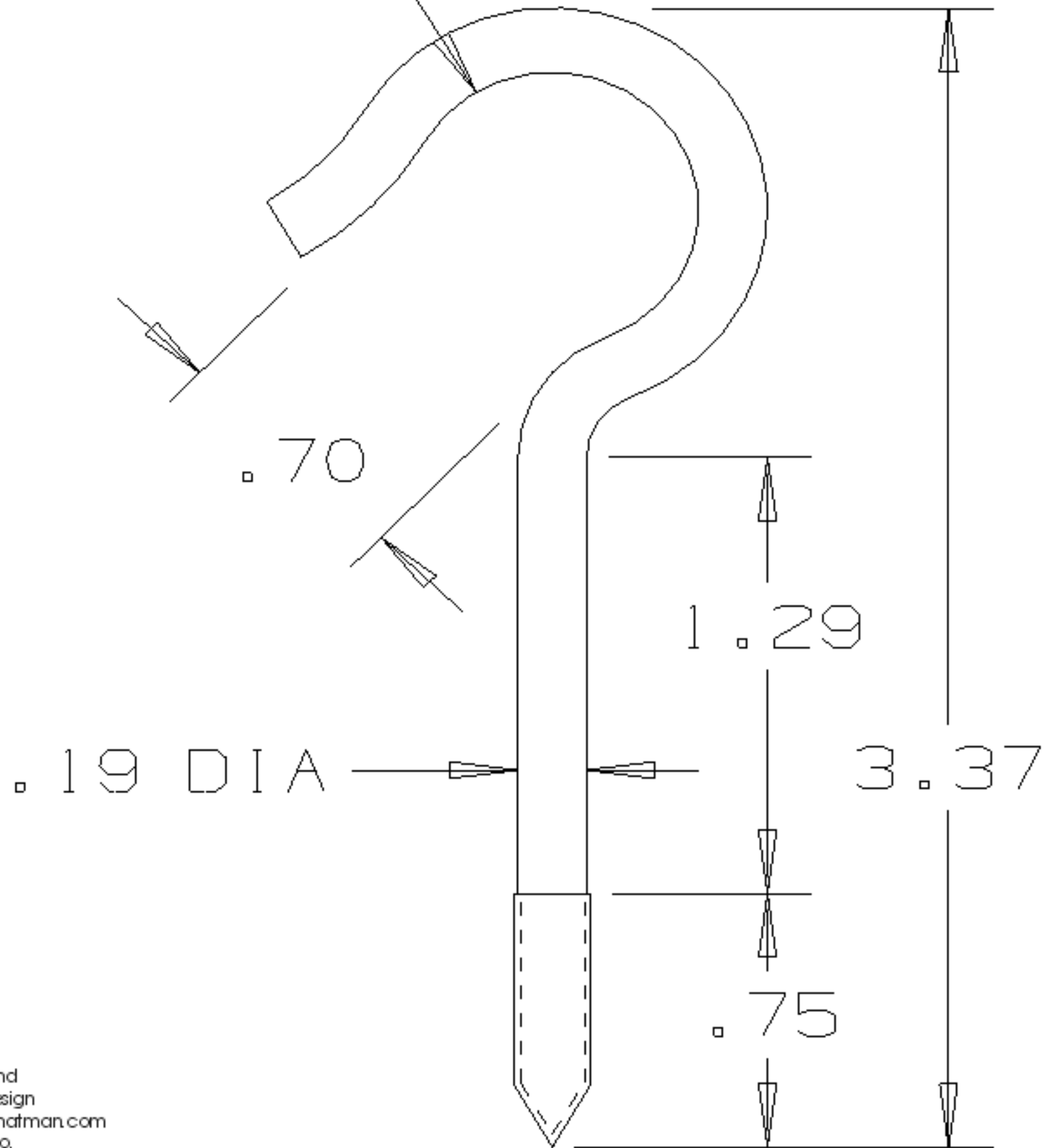

Dimensions shown are nominal and
subject to change. For critical design
specification, contact techinfo@natman.com
©2000 National Manufacturing Co.