



shepherd
HARDWARE PRODUCTS

Catalog

CHANGE IS GOOD....

Shepherd Hardware Products completed the most comprehensive packaging update in over a decade, to incorporate color-coded blister cards and expand our product lines in original ways. Our tagline "Best on the Floor" is taken seriously and we continually look for ways to improve and bring value to everyone who sells and uses our products.

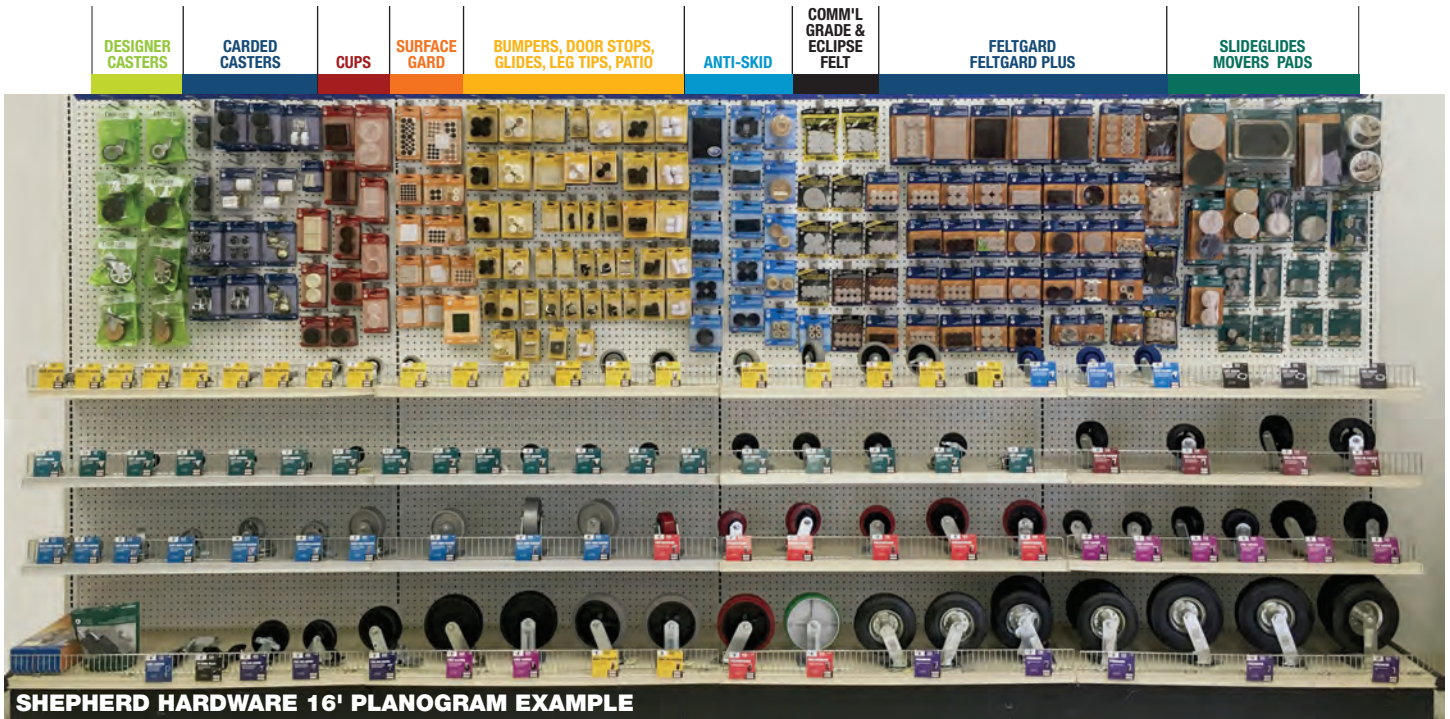

SHEPHERD HARDWARE 16' PLANOGRAM EXAMPLE

Find complete product images @ www.shepherdhardware.com

SYMBOLS

Glossary of the symbols and abbreviations used throughout catalog





















	= Caster Bearings		= Load Capacity Weight		= Rigid Caster
	= Caster Non-Bearings		= Master Carton Quantity		= Swivel Caster
	= Caster Overall Clearance		= Package Quantity (Blister)		= Shelf Carton Quantity
	= Caster Plate Dimensions		= Package Quantity (Polybag)		= Socket Inner Diameter
	= Caster Stem Dimensions		= Prop 65 Warning (the State of California recognizes these products to contain materials which may cause cancer and birth defects)	TPR	= Thermoplastic Rubber
	= Caster Stem - Threaded	PE	= Polyethylene	TPU	= Thermoplastic Urethane
	= Caster Wheel Width	PP	= Polypropylene		= Total Lock - WHEEL ROTATION AND SWIVEL SIMULTANEOUSLY LOCK
	= Diameter of any wheel	PU	= Polyurethane		= UPC code 039003
	= Dimensions	RTA	= Ready To Assemble		

TABLE OF CONTENTS

Anti-Skid Pads 40-41

- Self-Adhesive Pads
- Heavy Duty Screw-In Pads
- Slider n Gripper Pads & Cups

Casters Heavy Duty 4-11

- Full Ranges 4-9
 - Soft Rubber
 - Hard Rubber
 - Semi-Elastic Rubber
 - Cast Iron
 - Polypropylene
 - Mold-On TPR
 - Mold-On TPU
 - Mold-On Polyurethane

Specialized Ranges 10-11

- Mold-On Rubber
- Phenolic
- Polyamide
- Pneumatic
- Toolbox
- Gate Casters

Casters & Other Solutions 16-21

- Household and Office Use
 - Furniture Sockets 17
 - Bed Mobility 17
 - Bed Risers 17
 - Bed Sliders 17
 - Appliance Casters & Rollers 18
 - Hooded Ball 18
 - Light Duty 19
 - General Duty 19
 - Twin Wheels 20
 - Universal Office Chair Kit 21

Cups 38-39

- Carpet Base Metal
- Clear Spiked Plastic
- Clear Smooth Plastic
- Smooth Rubber
- Woodgrain Plastic

Designer Casters 12-15

- Color 13
- Smooth 13
- Mags 13
- Clear 13
- Hub-Free 14
- Saucers 14
- Woody 14
- Display Rack 15

Door Management 50-51

- Door Stops
 - Cushioned
 - Spring
 - Rubber Wedges
- Wall & Knob Protection
- Wedgelt® Plastic Skims

Felt 28-33

- Commercial Grade Felt 30
- FeltGard 31
- FeltGard Plus 32
- Eclipse Felt 33

Glides 48-49

- Carpet Base Nail-On
- Cushioned Nail-On
- Swivel Nail-On
- Plastic Base Tack
- Phenolic
- Swivel - Nylon Base
- Threaded Stem
- WonderLevel

Lazy Susans 55

Leg Tips 44-47

- Rubber 45
 - Leg Tips
 - Bulk Packaging
 - Crutch Tips
- Clear Plastic 46
- Vinyl 46
- Low Friction 46
- Plastic Square 46
- Plastic w/Felt Base 47
- Plastic 47
- Plastic Inside 47

Material Handling 26-27

- Home Series
 - Wooden Dollies
 - Steel Tri-Dollies
 - Platform Cart
- Premier Series
 - Platform Carts
 - Wooden Dollies
 - Movers Blankets

Patio Furniture Line 52-53

Sliders 36-37

- Self-Adhesive
- Self-Adhesive with Screws
- Cushioned Nail-On
- Threaded Appliance Sliders
- Rubber Leg Tips
- Rubber Cup Sliders

Snowmobile Dolly 55

Store & Reuse Movers Pads 34-35

- SlideGlide® / Carpets
- FeltGard® / Hardwood
- Combo Packs / Carpet & Hard Surface Floors

Surface Protection 42-43

- Felt Pads & Blankets
- Cork Pads
- Foam Pads
- Bumpers
- Clear Pads
- Value Packs
- Boxed Kit

Wheels 22-25

- Hard Rubber 24
- Semi Pneumatic 24
 - Metal Hub
 - Plastic Hub
- Flat Free 25
- Pneumatic 25
- Wheelbarrow 25
 - Complete Wheels
 - Tubeless Tires
 - Inner Tubes

HOW TO SELECT THE RIGHT SHEPHERD CASTER

CONSIDER THESE FOUR ELEMENTS...

1 The Load Rating

Determine the appropriate load rating per caster by totaling the weight of equipment plus load, divided by the number of casters installed. Larger diameter wheels generally support heavier loads but configuring with a greater number of smaller casters in a design is another option for safe and supported material handling.

**Example: 500 lbs anticipated load + 80 lbs wooden cart / 4 swivel casters
= 145 lbs minimum capacity per caster**

2 The Caster Type

- **Swivel Casters:** Swivel 360 degrees which allows for easy movement of the load in any direction.
- **Rigid Casters:** Do not swivel. They support the load and are mounted in parallel for linear movement.
- **Swivel Casters with Brake:** Swivel 360 degrees with a convenient locking feature to keep loads in-place when needed.

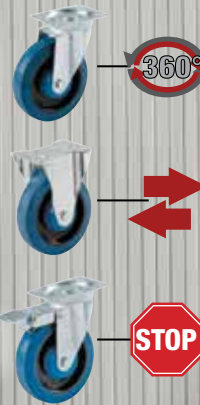

3 The Wheel Material

- Make sure the wheel selected is large enough to pass over cracks in the floor and other obstructions.
- If the casters are to be used on a very rough surface, a larger wheel size is recommended.
- Rubber wheels cushion the load while offering noise reduction and consistent floor protection.
- Hard rubber, TPU, TPR, mold-on and cast iron wheels are more resistant to harsh conditions with potential chemical or oil contact.

4 Caster Combinations

How many swivel and rigid casters are needed?

Various effective caster combinations can be used in the building, repairing and refurbishing of mobile equipment, such as trucks, benches, tables, etc. Several mounting patterns are illustrated to the right.

Compare Heavy-Duty Caster Characteristics

All casters are durable, non-marking, resilient to rough terrains and protect floors.

CASTER TYPE	SOUND DAMPENING	EXTREME TEMPS	SAFE FOR USE WITH				SAFE FOR USE ON			
			ACID	HEAT	OIL	WATER	CARPET	CERAMICS	CONCRETE	WOOD
SOFT RUBBER	●						●	●	●	●
HARD RUBBER	●	●		●	●		●	●	●	●
SEMI-ELASTIC SOFT RUBBER	●					●	●	●	●	●
CAST IRON		●	●	●	●				●	
POLYPROPYLENE		●	●		●	●	●		●	
MOLD-ON THERMOPLASTIC RUBBER	●	●			●	●	●	●	●	●
MOLD-ON THERMOPLASTIC URETHANE	●				●	●	●	●	●	●
MOLD-ON POLYURETHANE	●	●	●	●	●	●	●		●	
MOLD-ON RUBBER	●	●		●	●		●	●	●	●
PHENOLIC	●	●	●	●	●	●	●		●	
POLYAMIDE	●						●	●	●	●
PNEUMATIC	●	●				●	●		●	
TOOLBOX		●	●	●	●	●	●		●	
GATE CASTERS	●	●			●	●	●	●	●	●

Caster Type Combinations

— = Rigid ◯ = Swivel

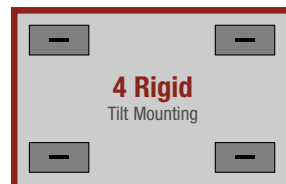
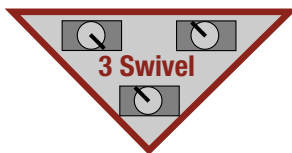

Swivel casters allow for full mobility.

Add a set of rigid casters for more controlled mobility.

CASTERS

HEAVY-DUTY

Organized into Full and Specialized Ranges of heavy-duty casters, this assortment offers several wheel material types fitted with load-appropriate steel rigs and plates and smooth ball bearing action. Find the perfect caster for interior or outdoor applications.



Full Ranges 4-9

- Soft Rubber
- Hard Rubber
- Semi-Elastic Rubber
- Cast Iron
- Polypropylene
- Mold-On TPR
- Mold-On TPU
- Mold-On Polyurethane

Specialized Ranges 10-11

- Mold-On Rubber
- Phenolic
- Polyamide
- Pneumatic
- Toolbox
- Gate Casters

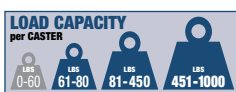

shepherd
HARDWARE PRODUCTS

SOFT RUBBER

1-1/4 - 6" range of solid **soft rubber** wheels for quiet operation over smooth, hard surfaces.

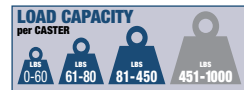

SKU	MARKETS AVAILABLE	UPC (0 39003)	CASTER TYPE	WHEEL DIAMETER	WHEEL COLOR	MOUNTING METHOD	PLATE SIZE	STEM SIZE	LOAD CAPACITY	CARTON QUANTITY
9487	ALL	09487 7	Swivel	1-1/4"	Black	Plate	1-5/16" x 1-13/16"		30	24
9488	ALL	09488 4	Rigid	1-1/4"	Black	Plate	13/16" x 1-1/2"		30	12
9489	ALL	09489 1	Swivel	1-1/2"	Black	Plate	1-1/2" x 1-13/16"		40	30
9490	ALL	09490 7	Rigid	1-1/2"	Black	Plate	1" x 1-13/16"		40	12
9008	USA ONLY	09008 4	Swivel	2"	Black	Grip Ring 87		1" x 3/8"	80	24
9190	CANADA ONLY	09190 6	Swvl + Brake	2"	Black	Thrd Stem 05		1-1/2" x 3/8"	80	24
9192	USA ONLY	09192 0	Swivel	2"	Black	Grip Ring 91		2" x 7/16"	80	24
9193	ALL	09193 7	Swivel	2"	Black	Grip Ring 89		1-3/8" x 7/16"	80	24
9194	ALL	09194 4	Swivel	2"	Black	Thrd Stem 05		1-1/2" x 3/8"	80	24
9477	ALL	09477 8	Swivel	2"	Black	Plate	1-7/8" x 2-5/8"		90	30
9481	ALL	09481 5	Rigid	2"	Black	Plate	1-3/8" x 2-1/16"		90	16
9509	ALL	09509 6	Swvl + Brake	2"	Black	Plate	1-7/8" x 2-5/8"		90	20
9191	USA ONLY	09191 3	Swivel	2-1/2"	Black	Grip Ring 87		1" x 3/8"	100	12
9197	ALL	09197 5	Swivel	2-1/2"	Black	Grip Ring 90		1-7/8" x 7/16"	100	12
9478	ALL	09478 5	Swivel	2-1/2"	Black	Plate	2-13/16" x 3-7/8"		100	10
9482	ALL	09482 2	Rigid	2-1/2"	Black	Plate	2-1/8" x 4-3/8"		100	8
9510	ALL	09510 2	Swvl + Brake	2-1/2"	Black	Plate	2-13/16" x 3-7/8"		100	10
9189	CANADA ONLY	09189 0	Swvl + Brake	3"	Black	Thrd Stem 05		1-1/2" x 3/8"	90	12
9195	ALL	09195 1	Swivel	3"	Black	Thrd Stem 05		1-1/2" x 3/8"	90	12
9479	ALL	09479 2	Swivel	3"	Black	Plate	3-1/8" 4-1/8"		175	10
9483	ALL	09483 9	Rigid	3"	Black	Plate	2-1/2" x 4-7/8"		175	8
9496	ALL	09496 9	Swvl + Brake	3"	Black	Thrd Stem 05		1-1/2" x 3/8"	150	4
9511	CANADA ONLY	09511 9	Swvl + Brake	3"	Black	Plate	3-1/8" 4-1/8"		175	10
3116	USA ONLY	03116 2	Swvl + Brake	4"	Black	Plate	2-3/8" x 3-5/8"		200	10
9034	CANADA ONLY	09034 3	Swvl + Brake	4"	Black	Thrd Stem 48		1-1/2" x 1/2"	115	6
9196	ALL	09196 8	Swivel	4"	Black	Thrd Stem 48		1-1/2" x 1/2"	115	6
9480	ALL	09480 8	Swivel	4"	Black	Plate	4-1/8" x 5"		225	5
9484	CANADA ONLY	09484 6	Rigid	4"	Black	Plate	3" x 6-3/16"		225	5
9512	ALL	09512 6	Swvl + Brake	4"	Black	Plate	4-1/8" x 5"		225	5
9629	USA ONLY	09629 1	Swivel	4"	Black	Plate	2-7/8" x 3-5/8"		200	10
9630	USA ONLY	09630 7	Swvl + Brake	4"	Black	Plate	2-7/8" x 3-5/8"		200	10
9659	USA ONLY	09659 8	Rigid	4"	Black	Plate	2-5/16" x 3-5/8"		200	10
9787	ALL	09787 8	Swivel	5"	Black	Plate	2-3/8" x 3-5/8"		200	4
9788	ALL	09788 5	Swvl + Brake	5"	Black	Plate	2-3/8" x 3-5/8"		200	4
9789	ALL	09789 2	Rigid	5"	Black	Plate	2-3/8" x 3-5/8"		200	4
9492	USA ONLY	09492 1	Rigid	6"	Black	Plate	2-3/8" x 3-5/8"		225	4

Soft rubber twin wheels with copper accent rig delivers higher load capacity and excellent mobility.



SKU	MARKETS AVAILABLE	UPC (0 39003)	CASTER TYPE	WHEEL DIAMETER	WHEEL COLOR	CASTER FINISH	MOUNTING METHOD	PLATE SIZE	LOAD CAPACITY	CARTON QUANTITY
9048	USA ONLY	09048 7	Swivel	2"	Black	Copper Oxide	Plate	3-5/8" x 2-9/16"	160	40

SAFE WITH NO ACID NO HEAT NO OIL NO WATER

HARD RUBBER

2 - 4" range of impact-resistant solid **hard rubber** wheels with relatively high load ratings that won't develop flat spots under load.

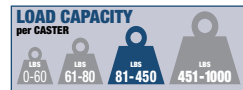

SKU	MARKETS AVAILABLE	UPC (0 39003)	CASTER TYPE	WHEEL DIAMETER	WHEEL COLOR	BRAKES	MOUNTING METHOD	PLATE SIZE	LOAD CAPACITY	CARTON QUANTITY
9270	USA ONLY	09270 5	Swivel	2"	Gray		Plate	1-7/8" x 2-5/8"	125	50
9271	USA ONLY	09271 2	Swvl + Brake	2"	Gray	✓	Plate	1-7/8" x 2-5/8"	125	50
9272	USA ONLY	09272 9	Rigid	2"	Gray		Plate	1-1/2" x 2-11/16"	125	50
9273	USA ONLY	09273 6	Swivel	2-1/2"	Gray		Plate	2-13/16" x 3-7/8"	175	30
9274	USA ONLY	09274 3	Swvl + Brake	2-1/2"	Gray	✓	Plate	2-13/16" x 3-7/8"	175	30
9275	USA ONLY	09275 0	Rigid	2-1/2"	Gray		Plate	2-1/8" x 4-7/8"	175	30
9276	USA ONLY	09276 7	Swivel	3"	Gray		Plate	3-1/8" x 4-1/8"	210	20
9277	USA ONLY	09277 4	Swvl + Brake	3"	Gray	✓	Plate	3-1/8" x 4-1/8"	210	20
9278	USA ONLY	09278 1	Rigid	3"	Gray		Plate	2-1/2" x 4-7/8"	210	20
9279	USA ONLY	09279 8	Swivel	4"	Gray		Plate	4-1/8" x 5"	255	10
9280	USA ONLY	09280 4	Swvl + Brake	4"	Gray	✓	Plate	4-1/8" x 5"	255	10
9281	USA ONLY	09281 1	Rigid	4"	Gray		Plate	3" x 6-3/16"	255	10

Hard rubber twin wheels with copper accent rig delivers higher load capacity and excellent mobility.



SKU	MARKETS AVAILABLE	UPC (0 39003)	CASTER TYPE	WHEEL DIAMETER	WHEEL COLOR	CASTER FINISH	MOUNTING METHOD	PLATE SIZE	LOAD CAPACITY	CARTON QUANTITY
9061	ALL	09061 9	Swivel	2"	Black	Copper Oxide	Plate	2-5/8" x 3-5/8"	200	40

SAFE WITH Acid NO Heat ✓ Oil ✓ Water NO

SEMI-ELASTIC SOFT RUBBER

3 - 5" range of quiet and smooth **semi-elastic** rolling casters. **Elastic blue** casters are extra-forgiving to regain shape over obstacles and resist abrasion. Total Lock brake simultaneously stops the caster wheel rotation and swivel motion.

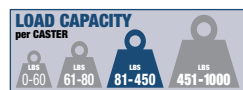

SKU	MARKETS AVAILABLE	UPC (0 39003)	CASTER TYPE	WHEEL DIAMETER	WHEEL COLOR	MOUNTING METHOD	PLATE SIZE	CASTER w/BRAKE	LOAD CAPACITY	CARTON QUANTITY
9285	ALL	09285 9	Swivel	3"	Black	Plate	3-1/8" x 3-7/8"		130	5
9286	CANADA ONLY	09286 6	Rigid	3"	Black	Plate	3-5/16" x 4-1/8"		130	10
9287	ALL	09287 3	Swvl + Brake	3"	Black	Plate	3-1/8" x 3-7/8"	TOTAL LOCK	130	5
9288	CANADA ONLY	09288 6	Swivel	4"	Black	Plate	3-1/8" x 3-7/8"		220	5
9289	ALL	09289 7	Rigid	4"	Black	Plate	3-5/16" x 4-1/8"		220	5
9290	ALL	09290 3	Swvl + Brake	4"	Black	Plate	3-1/8" x 3-7/8"	TOTAL LOCK	175	5
9291	ALL	09291 0	Swivel	5"	Black	Plate	3-1/8" x 3-7/8"		220	4
9292	ALL	09292 7	Rigid	5"	Black	Plate	3-5/16" x 4-1/8"		220	4
9293	ALL	09293 4	Swvl + Brake	5"	Black	Plate	3-1/8" x 3-7/8"	TOTAL LOCK	220	4
ELASTIC BLUE CASTERS										
9260	ALL	09260 6	Swivel	4"	Blue	Plate	3-1/8" x 3-7/8"		265	5
9261	ALL	09261 3	Rigid	4"	Blue	Plate	3-5/16" x 4-1/8"		265	5
9262	ALL	09262 0	Swvl + Brake	4"	Blue	Plate	3-1/8" x 3-7/8"	TOTAL LOCK	265	5
9263	CANADA ONLY	09263 7	Swivel	5"	Blue	Plate	3-1/8" x 3-7/8"		330	4
9264	CANADA ONLY	09264 4	Rigid	5"	Blue	Plate	3-5/16" x 4-1/8"		330	4
9265	CANADA ONLY	09265 1	Swvl + Brake	5"	Blue	Plate	3-1/8" x 3-7/8"	TOTAL LOCK	330	4

SAFE WITH Acid NO Heat NO Oil NO Water ✓

What are Total Lock Brakes?

A: Brakes that lock wheel and swivel simultaneously.

CAST IRON

2 - 6" range of temperature and heat resistant **cast iron** wheels for infrequently moved items on rough or concrete floors. 4" and larger casters are constructed with sturdier 1/4" plate mount and 3/4" steel roller bearings.

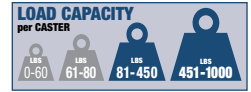

SKU	MARKETS AVAILABLE	UPC (0 39003)	CASTER TYPE	WHEEL DIAMETER	WHEEL COLOR	MOUNTING METHOD	PLATE SIZE	LOAD CAPACITY	CARTON QUANTITY
9174	ALL	09174 6	Swivel	2"	Silver	Plate	1-7/8" x 2-5/8"	125	12
9182	ALL	09182 1	Rigid	2"	Silver	Plate 13	1-1/2" x 2-11/16"	125	24
9176	USA ONLY	09176 0	Swivel	2-1/2"	Silver	Plate	2-13/16" x 3-7/8"	175	6
9184	USA ONLY	09184 5	Rigid	2-1/2"	Silver	Plate 18	2-1/8" x 4-3/8"	175	6
9780	ALL	09780 9	Swivel	3"	Silver	Plate	3-1/8" x 4-1/8"	250	4
9781	USA ONLY	09781 6	Rigid	3"	Silver	Plate 18	2-1/2" x 4-7/8"	250	4
9782	USA ONLY	09782 3	Swivel	4"	Silver	Plate	4-1/8" x 5"	500	4
9783	USA ONLY	09783 0	Rigid	4"	Silver	Plate	3" x 6-3/16"	500	4
3056	ALL	03056 1	Swivel	4"	Silver	Plate	4" x 4-3/8"	700	4
3057	ALL	03057 8	Rigid	4"	Silver	Plate	4" x 4-3/8"	700	4
3058	ALL	03058 5	Swivel	5"	Silver	Plate	4" x 4-3/8"	800	4
3059	ALL	03059 2	Rigid	5"	Silver	Plate	4" x 4-3/8"	800	4
3060	ALL	03060 8	Swivel	6"	Silver	Plate	4" x 4-3/8"	900	4
3061	ALL	03061 5	Rigid	6"	Silver	Plate	4" x 4-3/8"	900	4
3063	ALL	03063 9	Rigid	8"	Silver	Plate		1050	4

SAFE WITH Acid Heat Oil Water
 ✓ NO ✓ NO ✓ NO

POLYPROPYLENE

2 - 8" range of economical solid **Polypropylene (PP)** wheels with load-appropriate steel construction and plate mounts.

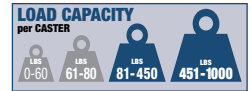

SKU	MARKETS AVAILABLE	UPC (0 39003)	CASTER TYPE	WHEEL DIAMETER	WHEEL COLOR	MOUNTING METHOD	PLATE SIZE	LOAD CAP	CARTON QUANTITY
9392	ALL	09392 4	Swivel	2"	Black	Plate	1-7/8" x 2-5/8"	125	36
9396	ALL	09396 2	Rigid	2"	Black	Plate	1-1/2" x 2-11/16"	125	24
9541	USA ONLY	09541 6	Swvl + Brake	2"	Black	Plate	1-7/8" x 2-5/8"	125	30
9393	ALL	09293 1	Swivel	2-1/2"	Black	Plate	2-13/16" x 3-7/8"	175	12
9397	USA ONLY	09397 9	Rigid	2-1/2"	Black	Plate	2-1/8" x 4-3/8"	175	6
9394	ALL	09394 8	Swivel	3"	Black	Plate	3-1/8" x 4-1/8"	210	4
9398	USA ONLY	09398 6	Rigid	3"	Black	Plate	2-1/8" x 4-3/8"	210	4
3118	ALL	03118 6	Swivel	4"	Black	Plate	4" x 4-3/8"	400	4
3119	ALL	03119 3	Rigid	4"	Black	Plate	4" x 4-3/8"	400	4
9543	USA ONLY	09543 0	Swvl + Brake	4"	Black	Plate	3-1/8" x 4-1/8"	210	6
9395	USA ONLY	09395 5	Swivel	4"	Black	Plate	4-1/8" x 5"	275	4
9399	USA ONLY	09399 3	Rigid	4"	Black	Plate	3" x 6-3/16"	275	4
9799	ALL	09799 1	Swvl + Brake	4"	Black	Plate	2-3/8" x 3-5/8"	275	4
9784	USA ONLY	09784 7	Swivel	4"	Gray	Plate	2-3/8" x 3-5/8"	275	4
9786	USA ONLY	09786 1	Rigid	4"	Gray	Plate	2-7/8" x 4-1/8"	275	4
9858	USA ONLY	09858 5	Swvl + Brake	4"	Gray	Plate	2-7/8" x 3-5/8"	275	4
9388	ALL	09388 7	Swivel	5"	Black	Plate	4" x 4-3/8"	500	4
9389	ALL	09389 4	Rigid	5"	Black	Plate	4" x 4-3/8"	500	4
3123	ALL	03123 0	Rigid	6"	Black	Plate	4" x 4-3/8"	550	4
3124	ALL	03124 7	Swivel	6"	Black	Plate	4" x 4-3/8"	550	4
3126	ALL	03123 0	Swivel	8"	Black	Plate	4" x 4-3/8"	600	2
3127	ALL	03124 7	Rigid	8"	Black	Plate	4" x 4-3/8"	600	2

SAFE WITH Acid Heat Oil Water
 ✓ NO ✓ NO ✓ NO

MOLD-ON THERMOPLASTIC RUBBER

2 - 8" range of soft **TPR** wheels, over PP hubs with load with load-appropriate steel construction and mounts for quiet and smooth operation.

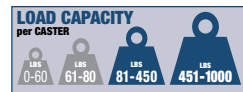

SKU	MARKETS AVAILABLE	UPC (0 39003)	CASTER TYPE	WHEEL DIAMETER	MOUNTING METHOD	PLATE SIZE	STEM SIZE L" x D"	THREAD SIZE	LOAD CAPACITY	CARTON QUANTITY
3264	ALL	03264 0	Swvl + Brake	2"	Thrd Stem 09		1" x 3/8"	3/8" x 16 x 1"	80	8
9790	ALL	09790 8	Swivel	2"	Grip Ring 82		1-7/16" x 7/16"		125	24
3258	ALL	03258 9	Swvl + Brake	2-1/2"	Grip Ring 82		1-7/16" x 7/16"		90	6
3259	ALL	03259 6	Swvl + Brake	2-1/2"	Thrd Stem 09		1" x 3/8"	3/8" x 16 x 1"	90	6
3265	ALL	03265 7	Swivel	3"	Thrd Stem 05		1-1/2" x 3/8"	3/8" x 16 x 1-1/2"	110	8
3266	ALL	03266 4	Swvl + Brake	3"	Thrd Stem 05		1-1/2" x 3/8"	3/8" x 16 x 1-1/2"	110	8
3545	ALL	03545 0	Swivel	3"	Plate	2-1/4" x 2-1/4"			121	10
3546	ALL	03546 7	Swvl + Brake	3"	Plate	2-1/4" x 2-1/4"			121	10
3547	ALL	03547 4	Rigid	3"	Plate	2-1/4" x 2-1/4"			121	10
3731	ALL	03731 7	Swivel	3"	Plate				180	8
3732	ALL	03732 4	Rigid	3"	Plate				180	8
3733	ALL	03733 1	Swvl + Brake	3"	Plate				180	8
9807	ALL	09807 3	Swivel	3"	Grip Ring 89		1-3/8" x 7/16"		175	12
3176	ALL	03176 6	Rigid	4"	Plate	4" x 4-1/4"			300	4
3177	ALL	03177 3	Swivel	4"	Plate	4" x 4-1/4"			300	4
3178	CANADA ONLY	03178 0	Swvl + Brake	4"	Plate				300	4
3735	CANADA ONLY	03735 5	Rigid	4"	Plate				250	4
3736	ALL	03736 2	Swvl + Brake	4"	Plate	2-7/8" x 3-5/8"			250	16
9735	ALL	09735 9	Swivel	4"	Plate				250	4
9736	ALL	09736 6	Swvl + Brake	4"	Plate				250	4
9737	ALL	09737 3	Rigid	4"	Plate	2-3/4" x 4"			250	4
9805	ALL	09805 9	Swivel	4"	Plate	2-7/8" x 3-5/8"			250	4
3179	ALL	03179 7	Rigid	5"	Plate	4" x 4-1/2"			450	4
3180	ALL	03180 3	Swivel	5"	Plate	4" x 4-1/2"			450	4
9738	ALL	09738 0	Swivel	5"	Plate	2-7/8" x 3-5/8"			300	4
9739	USA ONLY	09739 7	Swvl + Brake	5"	Plate	2-7/8" x 3-5/8"			350	4
9740	ALL	09740 3	Rigid	5"	Plate	2-7/8" x 4-1/16"			300	4
9810	CANADA ONLY	09810 3	Swivel	5"	Plate				300	4
9811	CANADA ONLY	09811 0	Rigid	5"	Plate				300	4
3182	ALL	03182 7	Rigid	6"	Plate	4" x 4-1/2"			550	4
3183	ALL	03183 4	Swivel	6"	Plate	4" x 4-1/2"			550	4
3184	CANADA ONLY	03183 1	Swvl + Brake	6"	Plate	4" x 4-1/2"			550	4
3186	ALL	03186 5	Swivel	8"	Plate	4" x 4-1/2"			700	2
9813	ALL	09813 4	Rigid	8"	Plate	4" x 4-1/2"			700	2

SAFE WITH Acid NO Heat NO Oil YES Water YES

MOLD-ON THERMOPLASTIC URETHANE

2 - 4" range of soft TPU wheels over PP hubs for quiet and smooth operation.

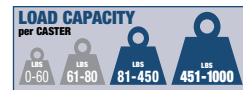

SKU	MARKETS AVAILABLE	UPC (0 39003)	CASTER TYPE	WHEEL DIAMETER	WHEEL COLOR	MOUNTING METHOD	PLATE SIZE	LOAD CAPACITY	CARTON QUANTITY
3541	ALL	03541 2	Swivel	2"	Gray	Plate	1-1/2" x 2"	88	24
3542	ALL	03542 9	Swvl + Brake	2"	Gray	Plate	1-1/2" x 2"	88	24
3543	ALL	03543 6	Rigid	2"	Gray	Plate	1-1/2" x 2"	88	24
3747	CANADA ONLY	03747 8	Swivel	4"	Gray	Plate		300	4
3748	CANADA ONLY	03748 5	Swvl + Brake	4"	Gray	Plate		300	4
3749	CANADA ONLY	03749 2	Rigid	4"	Gray	Plate		300	4
3755	ALL	03755 3	Swivel	3"	Orange	Plate	2-7/8" x 3-5/8"	225	10
3756	ALL	03756 0	Rigid	3"	Orange	Plate	2-7/8" x 3-5/8"	225	8
3757	ALL	03757 7	Swvl + Brake	3"	Orange	Plate	2-7/8" x 3-5/8"	225	10
3758	ALL	03758 4	Swivel	4"	Orange	Plate	2-7/8" x 3-5/8"	300	5
3759	ALL	03759 1	Rigid	4"	Orange	Plate	2-7/8" x 4-1/16"	300	5
3760	CANADA ONLY	03760 7	Swvl + Brake	4"	Orange	Plate	2-7/8" x 3-5/8"	300	5



MOLD-ON POLYURETHANE

3 - 8" range of mold-on PU wheels over PP or steel hubs with load-appropriate steel construction and mounts.

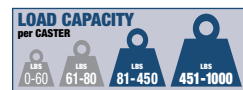

SKU	MARKETS AVAILABLE	UPC (0 39003)	CASTER TYPE	WHEEL DIAMETER	WHEEL COLOR	HUB COMPOSITION	MOUNTING METHOD	PLATE SIZE	STEM SIZE L" x D"	LOAD CAP	CARTON QUANTITY
3320	ALL	03320 3	Swivel	3"	Red	Polypropylene	Plate	2-5/8" x 2-5/8"		180	10
3321	CANADA ONLY	03321 0	Swivel Oeil	3"	Red	Polypropylene	Oeil-Stemless	2-5/8" x 2-5/8"		180	10
3322	CANADA ONLY	03322 7	Swivel	3"	Red	Polypropylene	Plate			180	10
3728	CANADA ONLY	03728 7	Swivel	3"	Black	Polypropylene	Plate	4" x 4-3/8"		225	50
3729	CANADA ONLY	03729 4	Swvl + Brake	3"	Black	Polypropylene	Thrd Stem 50		2-11/16" x 1/2"	225	50
3737	CANADA ONLY	03737 9	Swivel	3"		Polypropylene	Plate			225	25
3738	CANADA ONLY	03738 6	Rigid	3"		Polypropylene	Plate			225	25
3739	CANADA ONLY	03739 3	Swvl + Brake	3"		Polypropylene	Plate			225	25
3164	ALL	03164 3	Swivel	4"	Green	Steel	Plate	4" x 4-3/8"		700	4
3172	ALL	03172 8	Rigid	4"	Green	Steel	Plate	4" x 4-3/8"		700	4
3278	ALL	03278 7	Rigid	4"	Red	Polypropylene	Plate	4" x 4-3/8"		600	8
9186	USA ONLY	09186 9	Swvl + Brake	4"	Red	Steel	Plate	4" x 4-3/8"		700	4
3279	USA ONLY	03279 4	Swivel	5"	Red	Polypropylene	Plate	4" x 4-3/8"		750	4
3280	USA ONLY	03280 0	Rigid	5"	Red	Polypropylene	Plate	4" x 4-3/8"		750	4
9018	USA ONLY	09018 3	Swivel	5"	Gray	Polypropylene	Plate	2-7/8" x 3-5/8"		325	8
9019	USA ONLY	09019 0	Rigid	5"	Gray	Polypropylene	Plate	2-7/8" x 4-1/8"		325	8
9020	USA ONLY	09020 6	Swvl + Brake	5"	Gray	Polypropylene	Plate	2-7/8" x 3-5/8"		325	8
3166	ALL	03166 7	Swivel	6"	Green	Steel	Plate	4" x 4-3/8"		900	4
3174	CANADA ONLY	03174 2	Rigid	6"	Green	Steel	Plate	4" x 4-3/8"		900	4
9422	ALL	09422 8	Swivel	6"	Red	Polypropylene	Plate	4" x 4-3/8"		900	4
9424	ALL	09424 2	Rigid	6"	Red	Polypropylene	Plate	4" x 4-3/8"		900	4
3167	ALL	03167 4	Swivel	8"	Green	Steel	Plate	4" x 4-3/8"		1000	2
3175	ALL	03175 9	Rigid	8"	Green	Steel	Plate	4" x 4-3/8"		1000	2
3276	ALL	03276 3	Swivel	8"	Red	Polypropylene	Plate	4" x 4-1/2"		900	2
9187	ALL	09187 6	Swvl + Brake	8"	Red	Steel	Plate	4" x 4-3/4"		1000	2



MOLD-ON RUBBER

5 - 8" range of vibration and shock-absorbing **mold-on rubber** wheels over cast iron hubs with sturdy 1/4" plate mount and 3/4" steel roller bearings.

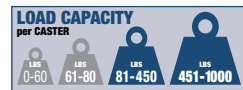

SKU	MARKETS AVAILABLE	UPC (0 39003)	CASTER TYPE	WHEEL DIAMETER	WHEEL COLOR	HUB COMPOSITION	MOUNTING METHOD	PLATE SIZE	LOAD CAPACITY	CARTON QUANTITY
3159	ALL	03159 9	Swivel	5"	Black	Cast Iron	Plate		330	4
3163	ALL	03163 6	Rigid	5"	Black	Cast Iron	Plate		330	4
9493	ALL	09493 8	Swivel	6"	Black	Cast iron	Plate		410	4
9494	ALL	09494 5	Rigid	6"	Black	Cast iron	Plate		410	4
3131	ALL	03131 5	Swivel	8"	Black	Cast Iron	Plate		500	2
3133	ALL	03133 9	Rigid	8"	Black	Cast Iron	Plate		500	2

SAFE WITH NO Acid Heat Oil Water

PHENOLIC

4 - 8" range of high-impact solid **phenolic** wheels with sturdy 1/4" plate mount and 3/4" steel roller bearings.

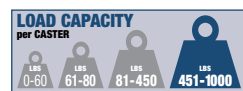

SKU	MARKETS AVAILABLE	UPC (0 39003)	CASTER TYPE	WHEEL DIAMETER	WHEEL COLOR	HUB COMPOSITION	MOUNTING METHOD	PLATE SIZE	LOAD CAP	CARTON QUANTITY
9770	CANADA ONLY	09770 0	Swivel	4"	Black	-	Plate		500	4
9771	CANADA ONLY	09771 7	Rigid	4"	Black	-	Plate		500	4
9779	CANADA ONLY	09779 3	Swvl + Brake	4"	Black	-	Plate		500	4
9774	ALL	09774 8	Swivel	6"	Black	-	Plate		840	4
9775	ALL	09775 5	Rigid	6"	Black	-	Plate		840	4
9778	CANADA ONLY	09778 6	Swvl + Brake	6"	Black	-	Plate		840	4
9776	CANADA ONLY	09776 2	Swivel	8"	Black	-	Plate		900	2
9777	CANADA ONLY	09777 9	Rigid	8"	Black	-	Plate		900	2

SAFE WITH ✓ Acid Heat Oil Water

POLYAMIDE

5" range of hard **polyamide** wheels surrounding shock-absorbing elastic rubber layer for quiet operation over obstacles. Total Lock brake simultaneously stops the caster wheel rotation and swivel motion.

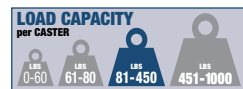

SKU	MARKETS AVAILABLE	UPC (0 39003)	CASTER TYPE	WHEEL DIAMETER	WHEEL COLOR	CASTER w/BRAKE	MOUNTING METHOD	PLATE SIZE	LOAD CAP	CARTON QUANTITY
9245	ALL	09245 3	Swivel	5"	Blue		Plate		200	4
9246	CANADA ONLY	09246 0	Rigid	5"	Blue		Plate		200	4
9247	ALL	09247 7	Swvl + Brake	5"	Blue	TOTAL LOCK	Plate		200	4

SAFE WITH NO NO NO NO NO Acid Heat Oil Water

What are Total Lock Brakes?

A: Brakes that lock wheel and swivel simultaneously.

PNEUMATIC

8 - 12" range of air-filled **pneumatic** rubber wheels with ball bearing rotation and sturdy steel plate mounts.



SKU	MARKETS AVAILABLE	UPC (0 39003)	CASTER TYPE	WHEEL DIAMETER	WHEEL COLOR	HUB COMPOSITION	MOUNTING METHOD	PLATE SIZE	LOAD CAPACITY	CARTON QUANTITY
9794	ALL	09794 6	Swivel	8"	Black	Steel	Plate	4" x 4-1/2"	220	4
9795	ALL	09795 3	Rigid	8"	Black	Steel	Plate	4" x 4-1/2"	220	4
9796	ALL	09796 0	Swivel	10"	Black	Steel	Plate	4" x 4-1/2"	350	4
9797	ALL	09797 7	Rigid	10"	Black	Steel	Plate	4" x 4-1/2"	350	4
3069	ALL	03069 1	Swivel	12"	Black	Steel	Plate	4" x 4-1/2"	450	2
3070	ALL	03070 7	Rigid	12"	Black	Steel	Plate	4" x 4-1/2"	450	2

SAFE WITH NO Acid Heat Oil Water

TOOLBOX

5 - 6" range of durable polyolefin **toolbox casters** with different brake types.

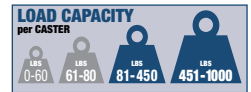

SKU	MARKETS AVAILABLE	UPC (0 39003)	CASTER TYPE	WHEEL DIAMETER	WHEEL COLOR	MOUNTING METHOD	PLATE SIZE	LOAD CAPACITY	CARTON QUANTITY
9011	ALL	09011 4	Swvl + Brake	5"	Black	Plate	2-1/2" x 3-1/2"	400	4
9012	ALL	09012 1	Swvl + Brake	5"	Black	Plate	2-1/2" x 3-1/2"	400	4
9013	ALL	09013 8	Swvl + Brake	6"	Black	Plate	4" x 4-1/2"	600	4

SAFE WITH NO Acid Heat Oil Water

GATE CASTERS

4 - 8" range of durable spring-loaded **gate casters** promote easy open and close and eliminate sag. Universal mounts can be attached to wooden or tubular steel gates with minimal effort.

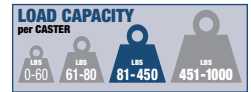

SKU	MARKETS AVAILABLE	UPC (0 39003)	CASTER TYPE	WHEEL DIAMETER	WHEEL COLOR	WHEEL COMPOSITION	MOUNTING METHOD	BRACKET SIZE H" x L" x W"	LOAD CAP	CARTON QUANTITY
9785	ALL	09785 4	Swivel	4"	Black	Hard Rubber	Bracket	4-1/8" x 4" x 15/16"	125	6
8735E	USA ONLY	09735 9	Swivel	5"	Black	Hard Rubber	Bracket	5-3/4" x 4-1/2" x 2"	220	1
9798	ALL	09798 4	Swivel	8"	Black	Pneumatic	Bracket	5-1/2" x 4" x 3-3/4"	200	4
8734E	USA ONLY	09734 2	Swivel	8"	Black	Flat-Free	Universal Bracket	5-1/2" x 4" x 3-3/4"	220	1

SAFE WITH NO Acid Heat Oil Water

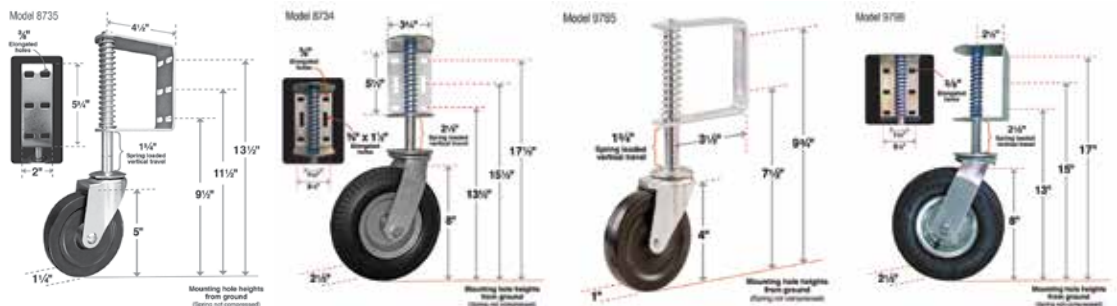

DESIGNER *Casters*

Express yourself with furniture-grade Designer Casters. Elegant and unique appeal with various non-marking wheel materials for use throughout the home. Several casters feature Total Lock brakes to simultaneously stop wheel rotation and swivel. Convenient plate mounting allows for easy transformations of tired furniture and adds stylish mobility to stationary items.



Color	13
- Cherry	
- Ocean	
- Honey	
- Kermit	
- Snow	
- Rhubarb	
- Sky	
Smooth	13
- Racer	
- Skate Wheel	
- Chrome Spokes	
Mags	13
- Chrome Bling	
- Black Bling	
- White Bling	
- Raw Bling	
Clear	13
- Mini Jewel	
- Jewel	
- Twin Jewel	
Hub-Free	14
- Vacant	
- Twin Wheel Vacant	
Saucers	14
- Petite	
Woody	14
- Trunk	
Display Rack	15

COLOR

Add more than a splash of color with non-marking 2" polypropylene 2-packs or commercial grade 3" polyurethane swivel casters with chrome finish and mount.



SKU	MARKETS AVAILABLE	DESCRIPTION	UPC (0 39003)	WHEEL COLOR	PLATE SIZE	WHEEL DIAMETER	OVERALL CLEARANCE	LOAD CAPACITY	PIECES BAG	CARTON PACK QUANTITY
6271	ALL	2" Cherry 2-Pack	06271 5	Red	1-7/8" x 1-7/8"	2"	2-7/8"	88	2	6
6272	ALL	2" Ocean 2-Pack	06272 2	Blue	1-7/8" x 1-7/8"	2"	2-7/8"	88	2	6
6273	ALL	2" Honey 2-Pack	06273 9	Yellow	1-7/8" x 1-7/8"	2"	2-7/8"	88	2	6
6274	ALL	2" Kermit 2-Pack	06274 6	Green	1-7/8" x 1-7/8"	2"	2-7/8"	88	2	6
6265	ALL	3" Snow	06265 4	White	2-1/2" x 2-1/2"	3"	4"	132	1	6
6266	ALL	3" Rhubarb	06266 1	Red	2-1/2" x 2-1/2"	3"	4"	132	1	6
6267	ALL	3" Sky	06267 8	Blue	2-1/2" x 2-1/2"	3"	4"	132	1	6

SMOOTH

Enjoy quiet mobility with smooth rolling non-marking swivel casters in 3" / 4" / 5" with complementary finish and mount.



SKU	MARKETS AVAILABLE	DESCRIPTION	UPC (0 39003)	WHEEL COLOR	PLATE SIZE	WHEEL DIAMETER	OVERALL CLEARANCE	LOAD CAPACITY	PIECES BAG	CARTON PACK QUANTITY
6293	ALL	3" Racer with black rubber tread	06293 7	Black	2-3/8" x 1-1/4"	3"	4"	75	1	4
6292	ALL	3" Skate Wheel with rubber tread	06292 0	Gray	2-3/8" x 1-1/4"	3"	4"	110	1	4
6268	ALL	3" Chrome Spokes with soft rubber tread	06268 5	Gray	2-1/2" x 3-5/8"	3"	4"	132	1	4
6269	ALL	4" Chrome Spokes with soft rubber tread	06269 2	Gray	2-7/8" x 3-5/8"	4"	5"	220	1	4
6270	ALL	5" Chrome Spokes with soft rubber tread	06270 8	Gray	2-7/8" x 3-5/8"	5"	6-1/8"	264	1	4

MAGS

Make it BLING with non-marking 3" swivel casters in machined aluminum with TPU tread, black on black, white on white, or natural patine colored polyurethane.



SKU	MARKETS AVAILABLE	DESCRIPTION	UPC (0 39003)	CASTER W/BRAKE	WHEEL COLOR	PLATE SIZE	WHEEL DIAMETER	OVERALL CLEARANCE	LOAD CAPACITY	PIECES BAG	CARTON PACK QUANTITY
6294	ALL	3" Chrome Bling with TPU tread	06294 4		TPU tread	2-3/8" x 2-3/8"	3"	4"	100	1	4
6295	ALL	3" Chrome Bling with TPU tread w/brake	06295 1	TOTAL LOCK	TPU tread	2-3/8" x 2-3/8"	3"	4"	100	1	4
6275	ALL	3" Black Bling	06275 3		Black	2-3/8" x 2-3/8"	3"	4"	100	1	4
6276	ALL	3" Black Bling w/brake	06276 0	TOTAL LOCK	Black	2-3/8" x 2-3/8"	3"	4"	100	1	4
6296	ALL	3" White Bling w/brake	06296 8	TOTAL LOCK	White	2-3/8" x 2-3/8"	3"	4"	100	1	4
6297	ALL	3" White Bling	06297 5		White	2-3/8" x 2-3/8"	3"	4"	100	1	4
6298	ALL	3" Raw Bling	06298 2		Raw	2-3/8" x 2-3/8"	3"	4"	100	1	4
6299	ALL	3" Raw Bling w/brake	06299 9	TOTAL LOCK	Raw	2-3/8" x 2-3/8"	3"	4"	100	1	4

What are Total Lock Brakes?

A: Brakes that lock wheel and swivel simultaneously.

CLEAR

Transparently chic non-marking polyurethane swivel caster 2-packs and twin wheel singles with chrome finish and mount.



SKU	MARKETS AVAILABLE	DESCRIPTION	UPC (0 39003)	CASTER W/BRAKE	WHEEL COLOR	PLATE SIZE	WHEEL DIAMETER	OVERALL CLEARANCE	LOAD CAPACITY	PIECES BAG	CARTON PACK QUANTITY
6278	ALL	1-3/8" Mini Jewel 2-Pack	06278 4		Clear	1-5/8" x 1-5/8"	1-3/8"	2"	88	2	6
6277	ALL	1-3/8" Mini Jewel 2-Pack w/brake	06277 7	✓	Clear	1-5/8" x 1-5/8"	1-3/8"	2"	88	2	6
6280	ALL	2" Jewel 2-Pack	06280 7		Clear	1-5/8" x 1-5/8"	2"	2-1/2"	110	2	6
6279	ALL	2" Jewel 2-Pk w/brake	06279 1	✓	Clear	1-5/8" x 1-5/8"	2"	2-1/2"	110	2	6
6283	ALL	2" Twin Jewel	06283 8		Clear	1-5/8" x 1-5/8"	2"	2-1/2"	77	1	6

HUB-FREE

Achieve hollow elegance with unforgettable non-marking polyurethane hub-free swivel casters with chrome finish and mount.



SKU	MARKETS AVAILABLE	DESCRIPTION	UPC (0 39003)	CASTER w/BRAKE	WHEEL COLOR	PLATE SIZE	WHEEL DIAMETER	OVERALL CLEARANCE	LOAD CAPACITY	PIECES BAG	CARTON QUANTITY
6281	ALL	2-3/8" Vacant	06281 4		Chrome	1-7/8" x 1-7/8"	2-3/8"	3-5/8"	88	1	4
6282	ALL	2-3/8" Vacant w/brake	06282 1	Brake	Chrome	1-7/8" x 1-7/8"	2-3/8"	3-5/8"	88	1	4
6290	ALL	3" Twin Wheel Vacant	06290 6		Chrome	1-7/8" x 1-7/8"	3"	3-7/8"	121	1	4
6291	ALL	3" Twin Wheel Vacant w/brake	06291 3	Brake	Chrome	1-7/8" x 1-7/8"	3"	3-7/8"	121	1	4

SAUCERS

There is nothing unidentifiable about these sleek aluminum swivel casters with non-marking polyethylene tread, chrome finish and mount.

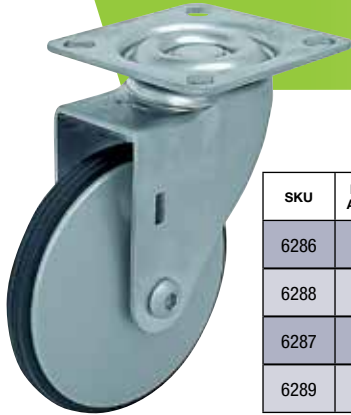

SKU	MARKETS AVAILABLE	DESCRIPTION	UPC (0 39003)	CASTER w/BRAKE	WHEEL COLOR	PLATE SIZE	WHEEL DIAMETER	OVERALL CLEARANCE	LOAD CAPACITY	PIECES BAG	CARTON QUANTITY
6286	ALL	2" Aluminum Petite with PE tread	06286 9		Aluminum	1-5/8" x 1-5/8"	2"	2-1/2"	66	1	4
6288	ALL	2" Aluminum Petite with PE tread w/brake	06288 3	Brake	Aluminum	1-5/8" x 1-5/8"	2"	2-1/2"	66	1	4
6287	ALL	3" Aluminum Petite with PE tread	06287 6		Aluminum	2-3/8" x 2-3/8"	3"	3-3/4"	77	1	4
6289	ALL	3" Aluminum Petite with PE tread w/brake	06289 0	Brake	Aluminum	2-3/8" x 2-3/8"	3"	3-3/4"	77	1	4

WOODY

Get back to the natural look with solid beechwood core swivel casters with non-marking TPU tread, chrome finish and mount.



SKU	MARKETS AVAILABLE	DESCRIPTION	UPC (0 39003)	CASTER w/BRAKE	WHEEL COLOR	PLATE SIZE	WHEEL DIAMETER	OVERALL CLEARANCE	LOAD CAPACITY	PIECES BAG	CARTON QUANTITY
6284	ALL	3" Wooden Trunk with TPU tread	06284 5		Wood	2-3/8" x 2-3/8"	3"	4"	100	1	4
6285	ALL	3" Wooden Trunk with TPU tread w/brake	06285 2	TOTAL LOCK	Wood	2-3/8" x 2-3/8"	3"	4"	100	1	4

What are Total Lock Brakes?

A: Brakes that lock wheel and swivel simultaneously.



DISPLAY RACK

Easy to assemble powder coated metal rack displays 20 cartons and supports a header sign.



SKU	MARKETS AVAILABLE	DESCRIPTION	UPC (0 39003)	COLOR	HEIGHT w/SIGN	WIDTH	DEPTH	CARTON QUANTITY
4560	ALL	Display rack with color header sign	04560 2	Gray	72"	27"	11"	1



CASTERS & OTHER SOLUTIONS

HOUSEHOLD & OFFICE USE

From bed rollers, risers and sliders to appliance moving aids, this assortment provides solutions to common household problems. A full range of light and general duty casters plus extensive twin wheel options for refreshing every room in the home.



Furniture Sockets	17
Bed Mobility & Sliders	17
Bed Risers	17
Appliance Casters & Rollers	18
Hooded Ball	18
Light Duty	19
General Duty	19
Twin Wheels	20
Universal Office Chair Caster Kits	21

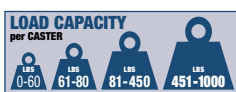

shepherd
HARDWARE PRODUCTS

FURNITURE SOCKETS

Metal and plastic **sockets** are inserted into bed frames and tubular furniture to receive common friction stems.



SKU	MARKETS AVAILABLE	SOCKET MATERIAL	UPC (0 39003)	SOCKET COLOR	SOCKET INNER DIAMETER	PIECES PER CARD	CARTON PACK QUANTITY
9439	ALL	Metal	09439 6	Metal	3/8"	4	6
9440	CANADA ONLY	Plastic	09440 2	White	3/8"	4	6
9064	ALL	Plastic	09064 0	White	1/2"	4	6
9066	ALL	Plastic	09066 4	White	5/8"	4	6
9069	ALL	Plastic	09069 5	White	3/4"	4	6
9071	USA ONLY	Plastic	09071 8	White	7/8"	4	6
9073	USA ONLY	Plastic	09073 2	White	1"	4	6

BED MOBILITY

Bed rollers are designed for wood and metal bed frames. Provides easy movement and maximum floor protection by distributing weight over larger area. Adjustable bed rollers (9532) utilize the wasted space beneath your bed and will safely accommodate storage boxes up to 10" high. **SLIDE GLIDE® bed sliders** reduce the friction between your bed and carpeting for easy movement to clean or rearrange the bedroom. Sliders snap directly into bed frame or are combined with included inserts to replace existing legs or casters and provide added inches of clearance for under bed storage.

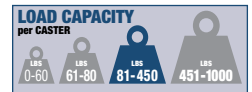

SKU	MARKETS AVAILABLE	UPC (0 39003)	CASTER TYPE	WHEEL COLOR	MOUNTING METHOD	TREAD TYPE		WHEEL DIAMETER	LOAD CAPACITY	PIECES PER PACK	CARTON PACK QUANTITY
						HARD	SOFT				
9518	CANADA ONLY	09518 8	Swvl + Brk	Black	Stem 04		✓	2-1/8"	125	2	6
9532	ALL	09532 4	Swvl + Brk	Black	Stem 04		✓	2-1/8"	125	2	4
9535	ALL	09535 5	Swivel	White	Stem 04	✓		2-1/8"	125	2	6
9536	ALL	09536 2	Swvl + Brk	White	Stem 04	✓		2-1/8"	125	2	6
BED SLIDERS											
8569	ALL	08569 1	—	Black	Stem 04	✓		—	250	2	6

WARNING: Cancer — www.P65Warnings.ca.gov.

- ✓ Hard Tread for Carpets
- ✓ Soft Tread for Hard Surface Floors

TIP:
For best floor protection, use soft tread on hard surface floors and hard tread on carpeted floors.



BED RISERS

Bed risers nest casters or bed posts up to 3" in diameter and elevate your bed 5" to create extra storage space or for easier in-and-out. Impervious to insects and water with a 300 lb. load capacity each, risers have countless uses indoors and outside.



SKU	MARKETS AVAILABLE	TYPE	UPC (0 39003)	COLOR	ELEVATED HEIGHT	LOAD CAPACITY EACH RISER	PIECES PER SET	CARTON PACK QUANTITY
9523	USA ONLY	Injection Molded	09523 0	Black	6-1/8"	300	4	4



TIP:
When minor flooding seems imminent, bed risers are a temporary solution to elevate furniture to avoid water damage.

Furniture Casters

Attachment & Installation Styles

- A. Threaded** stem mates with a nut or threaded cavity for a secure install
- B. Grip Ring** stem locks into a socket inside furniture and is easily inserted and removed
- C. Friction** stem locks into a socket located inside furniture and is easily inserted and removed

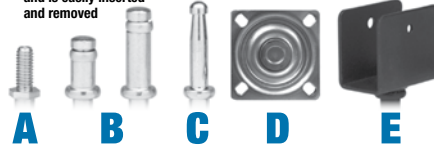

- D. Plate** mounts directly to furniture with four screws
- E. U-Bracket** envelops pressboard furniture for a secure install

Threaded stems

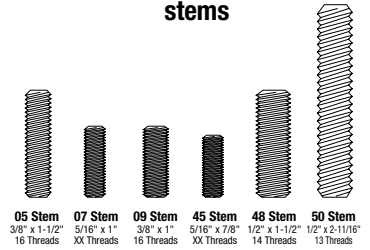

APPLIANCE CASTERS & ROLLERS

Appliance **casters** are low profile PP twin wheels that thread directly into heavy appliances. **Rollers** are low profile sets of PP wheels mounted to adjustable length platforms of steel, aluminum or plastic. Each solution allows for easy movement of heavy refrigerators and appliances.



9441

SKU	MARKETS AVAILABLE	UPC (0 39003)	THREADED STEM	WHEEL COLOR	ROLLER MATERIAL	ADJUSTABLE LENGTH	TREAD TYPE		WHEEL DIAMETER	LOAD CAPACITY	PIECES PKG	CARTON QUANTITY
							HARD	SOFT				
9441	ALL	09441 9	✓	White	—	—	✓	—	7/8"	250 each	4	6
9601	ALL	09601 7	—	White	Stamped Steel	16-5/8" — 25"	✓	—	—	1200	2	10
9603	USA ONLY	09603 1	—	White	Aluminum	18-1/4" — 28"	✓	—	—	2000	4	5
9848	ALL	09848 6	—	White	White Plastic	19" — 26"	✓	—	—	1200	2	10

*Not recommended for use on cushioned vinyl floors

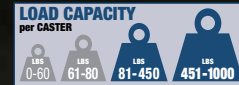
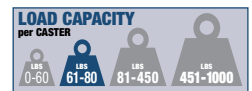

image shows 9603 Aluminum Appliance Roller in use

HOODED BALL

Black rubber spherical wheels with ball bearing swivel and protective **hood** for use on small sofas, chairs, and TV stands.



SKU	MARKETS AVAILABLE	UPC (0 39003)	CASTER TYPE	WHEEL DIAMETER	CASTER FINISH	WHEEL MATERIAL	WHEEL COLOR	MOUNTING METHOD	PLATE SIZE	STEM SIZE	SOFT TREAD	LOAD CAP	PCS PKG	CRTN QTY
9352	USA ONLY	09352 8	Swivel	1-5/8"	Brass	Rubber	Black	Stem 02	—	5/16" x 1-1/2"	✓	75	2	6
9353	USA ONLY	09353 5	Swivel	1-5/8"	Brass	Rubber	Black	Plate 13	1-1/8" x 2"	—	✓	75	2	6
9354	ALL	09354 2	Swivel	2"	Brass	Rubber	Black	Stem 02	—	5/16" x 1-1/2"	✓	80	2	6
9355	USA ONLY	09355 9	Swivel	2"	Brass	Rubber	Black	Plate 18	1-1/2" x 2-1/8"	—	✓	80	2	6
9360	CANADA ONLY	09360 3	Swivel	2"	Chrome	Rubber	Black	Stem 82	—	5/16" x 1-1/2"	✓	80	2	6
9685	USA ONLY	09685 7	Swivel	2"	Chrome	Rubber	Black	Stem 87	—	3/8" x 1"	✓	80	1	6
9686	USA ONLY	09686 4	Swivel	2"	Chrome	Rubber	Black	Stem 82	—	7/16" x 1-7/16"	✓	80	1	6
BULK HOODED BALL CASTERS														
9516	USA ONLY	09516 4	Swivel	2"	Brass	Rubber	Black	Stem 07	—	5/16" x 1"	✓	80	—	12
9517	USA ONLY	09517 1	Swivel	2"	Brass	Rubber	Black	Plate 18	1-1/2" x 2-1/8"	—	✓	80	—	12
9721	ALL	09721 2	Swivel	2"	Chrome	Rubber	Black	Plate 18	1-1/2" x 2-1/8"	—	✓	80	2	24
9722	ALL	09722 9	Swivel	2"	Chrome	Rubber	Black	Stem 02	—	5/16" x 1-1/2"	✓	80	2	24

Grip Ring stems

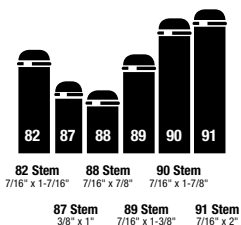

Friction stems



Plates

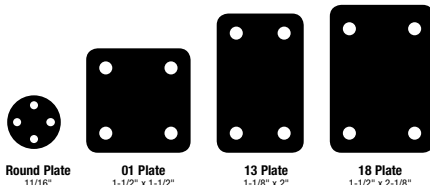

U-Bracket

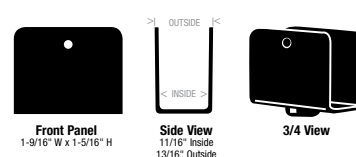

LIGHT DUTY CASTERS

Economical **plastic wheels** with stem or plate mount for use on light weight furniture and most indoor floors. Decorative wooden wheels are perfectly suited for antiques.

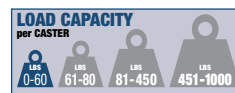

SKU	MARKETS AVAILABLE	UPC (0 39003)	CASTER TYPE	WHEEL DIAMETER	CASTER FINISH	WHEEL MATERIAL	WHEEL COLOR	MOUNTING METHOD	PLATE SIZE	STEM SIZE	HARD TREAD	LOAD CAP	PCS PKG	CRTN QTY
9052	ALL	09052 7	Swivel	1-1/4"	Zinc	Plastic	White	Plate	1-1/4" x 1-3/4"	—	✓	40	4	6
9053	ALL	09053 4	Swivel	1-1/4"	Zinc	Plastic	White	Stem 02	—	5/16" x 1-1/2"	✓	40	4	6
9556	ALL	09556 0	Swivel	1-1/4"	Zinc	Plastic	Black	Plate	—	—	✓	40	4	6
9557	ALL	09557 7	Swivel	1-1/4"	Zinc	Plastic	Black	Stem 02	—	5/16" x 1-1/2"	✓	40	4	6
9051	USA ONLY	09051 0	Swivel	1-5/8"	Brass	Wood	Brown	Stem 02	—	5/16" x 1-1/2"	✓	35	2	6
9054	ALL	09054 1	Swivel	1-5/8"	Zinc	Plastic	White	Plate	1-1/4" x 1-3/4"	—	✓	50	4	6
9055	ALL	09055 8	Swivel	1-5/8"	Zinc	Plastic	White	Stem 02	—	5/16" x 1-1/2"	✓	50	4	6
9558	ALL	09558 4	Swivel	1-5/8"	Zinc	Plastic	Black	Plate	1-1/4" x 1-3/4"	—	✓	50	4	6
9559	USA ONLY	09559 1	Swivel	1-5/8"	Zinc	Plastic	Black	Stem 02	—	5/16" x 1-1/2"	✓	50	4	6
9040	USA ONLY	09040 4	Swivel	2"	Zinc	Plastic	White	Stem 04	—	3/8" x 1-1/2"	✓	60	2	6
9041	USA ONLY	09041 1	Swivel	2"	Zinc	Plastic	White	Plate 13	1-1/8" x 2"	—	✓	60	2	6

GENERAL DUTY CASTERS

Soft black **rubber wheels** with double ball bearing construction for instant swiveling and smooth, silent operation. These are the industry standard for wood base office furniture, appliances, equipment, and displays.

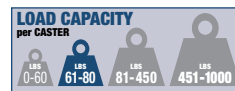

SKU	MARKETS AVAILABLE	UPC (0 39003)	CASTER TYPE	WHEEL DIAMETER	CASTER FINISH	WHEEL MATERIAL	WHEEL COLOR	MOUNTING METHOD	PLATE SIZE	STEM SIZE	SOFT TREAD	LOAD CAP	PCS PKG	CRTN QTY
9347	ALL	09347 4	Swivel	1-5/8"	Copper Oxide	Rubber	Black	Stem 02	—	5/16" x 1-1/2"	✓	70	2	6
9348	USA ONLY	09348 1	Swivel	1-5/8"	Copper Oxide	Rubber	Black	Plate 13	1-1/8" x 2"	—	✓	70	2	6
9344	ALL	09343 6	Swivel	2"	Chrome	Rubber	Black	Stem 07	—	5/16" x 1"	✓	80	2	6
9345	ALL	09345 0	Swivel	2"	Copper Oxide	Rubber	Black	Stem 02	—	5/16" x 1-1/2"	✓	80	2	6
9346	ALL	09346 7	Swivel	2"	Copper Oxide	Rubber	Black	Plate 13	1-1/8" x 2"	—	✓	80	2	6
BULK CASTERS														
9188	USA ONLY	09188 3	Swivel	1-5/8"	Copper Oxide	Rubber	Black	Stem 02	—	5/16" x 1-1/2"	✓	70	—	24
9020	ALL	09020 6	Swivel	2"	Copper Oxide	Rubber	Black	Plate 13	1-1/8" x 2"	—	✓	80	—	24

TWIN WHEELS

Twin wheels rotate independently for quick and smooth direction changes and minimal carpet wear. Hard nylon is best on carpet, while soft, coated options protect hard surface floors from damage. For use on RTA furniture, office chairs and more.

LOAD CAPACITY per CASTER			
LBS 0-60	LBS 61-80	LBS 81-450	LBS 451-1000

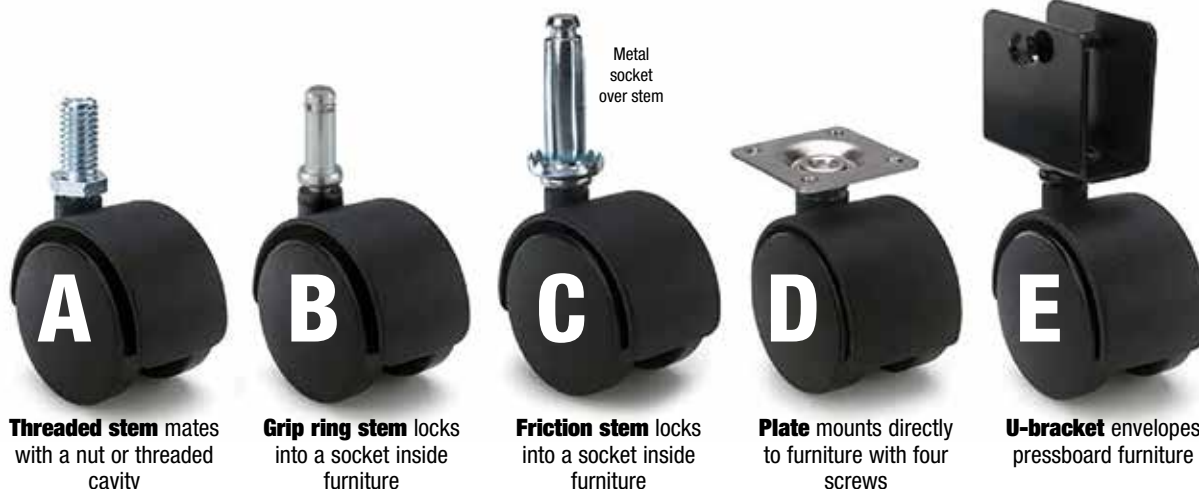

A
Threaded stem mates with a nut or threaded cavity

B
Grip ring stem locks into a socket inside furniture

C
Friction stem locks into a socket inside furniture

D
Plate mounts directly to furniture with four screws

E
U-bracket envelopes pressboard furniture

HARD & SOFT TREAD

Hard tread is ideal for carpeted floors and soft tread was developed for hard surface floors.



SKU	MARKETS AVAILABLE	UPC (0 39003)	CASTER TYPE	WHEEL DIAMETER	WHEEL COLOR	MOUNTING METHOD	PLATE SIZE	STEM SIZE	TREAD TYPE		LOAD CAPACITY	PIECES PKG	CARTON QUANTITY
									HARD	SOFT			
9401	ALL	09401 3	Swivel	1-5/8"	Black	Plate 01	1-1/2" x 1-1/2"	—	✓		40	2	6
9402	ALL	09402 0	Swivel	1-5/8"	Black	Stem 02	—	5/16" x 1-1/2"	✓		40	2	6
9420	ALL	09420 4	Swivel	1-5/8"	Black	U-Bracket	—	—	✓		40	2	6
9405	ALL	09405 1	Swvl + Brk	2"	Black	Plate 01	1-1/2" x 1-1/2"	—	✓		75	2	6
9406	ALL	09406 8	Swvl + Brk	2"	Black	Stem 02	—	5/16" x 1-1/2"	✓		75	2	6
9417	ALL	09417 4	Swivel	2"	Black	Plate 01	1-1/2" x 1-1/2"	—	✓		75	2	6
9418	ALL	09418 1	Swivel	2"	Black	Stem 02	—	5/16" x 1-1/2"	✓		75	2	6
9419	CANADA ONLY	09419 8	Swivel	2"	Black	Stem 82	—	7/16" x 1-7/16"	✓		75	2	6
9672	USA ONLY	09672 7	Swivel	2"	Black	Stem 07	—	5/16" x 1"	✓		75	1	6
9673	USA ONLY	09673 4	Swivel	2"	Black	Stem 87	—	3/8" x 1"	✓		75	1	6
9674	USA ONLY	09674 1	Swivel	2"	Black	Stem 82	—	7/16" x 1-7/16"	✓		75	1	6
9694	ALL	09694 9	Swivel	2"	Black	Stem 88	—	7/16" x 7/8"	✓		75	1	6
3910	ALL	03910 6	Swivel	2"	Gray	Plate 01	1-1/2" x 1-1/2"	—		✓	75	2	6
3911	ALL	03911 3	Swivel	2"	Gray	Stem 02	—	5/16" x 1-1/2"		✓	75	2	6
3912	ALL	03912 0	Swivel	2"	Gray	Stem 88	—	7/16" x 7/8"		✓	75	2	6
9403	ALL	09403 7	Swivel	2"	Black	Plate 01	1-1/2" x 1-1/2"	—		✓	75	2	6
9404	ALL	09404 4	Swivel	2"	Black	Stem 02	—	5/16" x 1-1/2"		✓	75	2	6
9428	CANADA ONLY	09428 0	Swivel	2"	Black	Stem 88	—	7/16" x 7/8"		✓	75	1	4
BULK TWIN WHEELS													
9733	USA ONLY	09733 5	Swivel	2"	Black	Stem 07	—	5/16" x 1"	✓		75	—	24
9741	USA ONLY	09741 0	Swivel	2"	Black	Stem 88	—	7/16" x 7/8"	✓		75	—	24

- ✓ Hard Tread for Carpets
- ✓ Soft Tread for Hard Surface Floors

Patent Pending

LOAD CAPACITY per CASTER

0-60 LBS	61-80 LBS	81-450 LBS	451-1000 LBS
----------	-----------	------------	--------------



Universal Office Chair Caster Kits

8747 - Nylon Tread for Carpeted Surfaces
8748 - Soft Tread for Hard Surface Floors

2" Wheels Compatible with All Grip Ring Stem Office Chairs*

Nylon and Soft Tread Versions Available for Carpeting or Hard Floors

Kit Contains 5 Casters - Enough to Overhaul One Office Chair

Simple Install

1 = 75 LBS

5 = 375 LBS

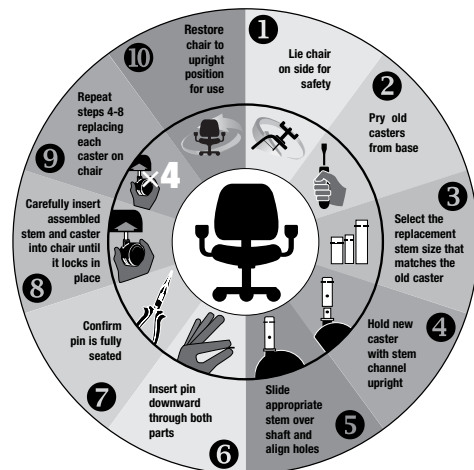

UNIVERSAL OFFICE CHAIR CASTER KITS

Grip ring stems lock into sockets beneath office chairs and can be easily removed and replaced. This set includes three of the most common stem sizes to fit most office chairs*.



SKU	MARKETS AVAILABLE	UPC (0 39003)	CASTER TYPE	WHEEL DIAMETER	WHEEL COLOR	PLATE SIZE	GRIP RING STEM TYPE	TREAD TYPE		LOAD CAPACITY	PIECES PER PACKAGE	CARTON PACK QUANTITY
								HARD	SOFT			
8747	ALL	08747 3	Swivel	2"	Black	None	82/87/88	✓		75	5	6
8748	ALL	08748 0	Swivel	2"	Gray	None	82/87/88		✓	75	5	6

*Not compatible with IKEA chairs

WHEELS

An expanded selection of the most commonly used household, heavy-duty, lawn/garden and material handling wheels. The line includes economical rust free plastic hubs, sturdy ball bearing steel hubs for more demanding applications, flat free and pneumatic tires.



Hard Rubber	24
Semi Pneumatic	24
- Metal Hub	
- Plastic Hub	
Flat Free	25
Pneumatic	25
Wheelbarrow	25
- Complete Wheels	
- Tubeless Tires	
- Inner Tubes	

How to Measure: Tires & Wheels

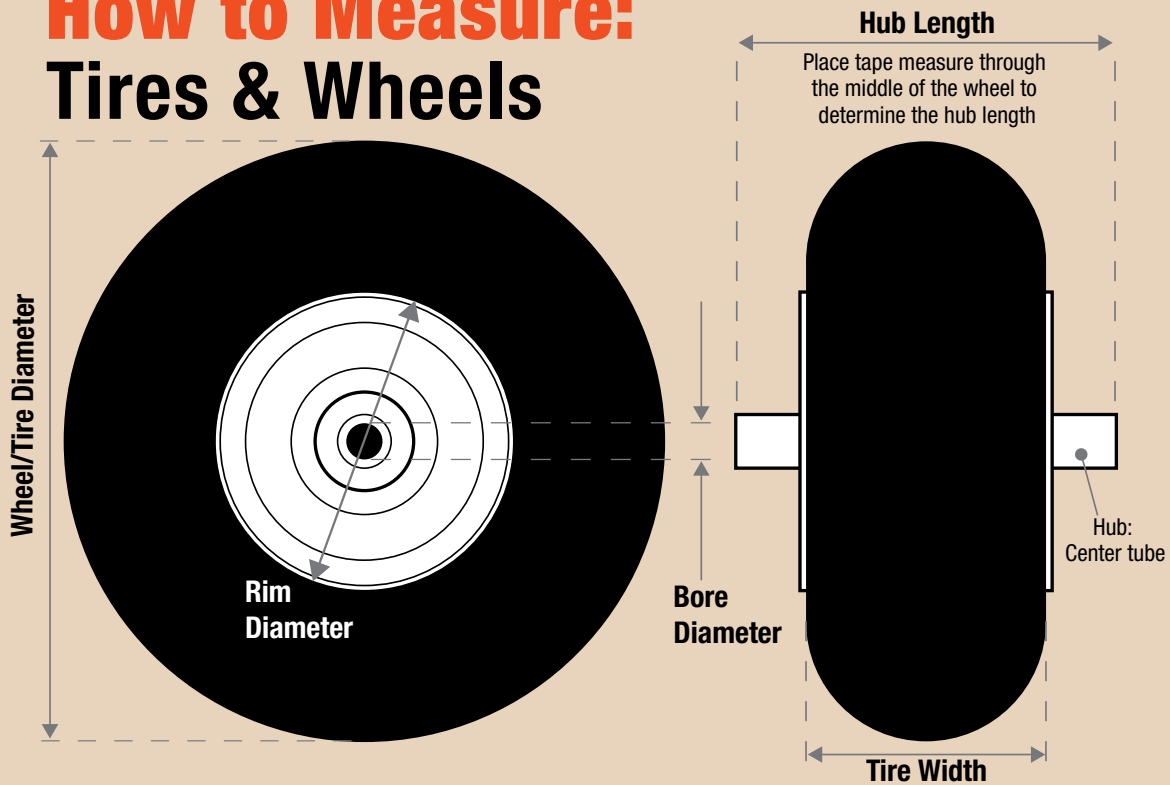

The hub is a horizontal center opening of a wheel that mates with another product's axle or other mounting point.

Centered vs. Offset

HUB POSITION

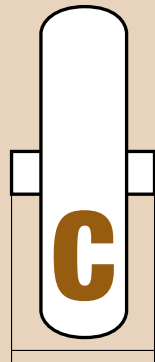

A centered hub is positioned so there is equal wheel clearance on each side.

Always choose the same style as wheel being replaced.

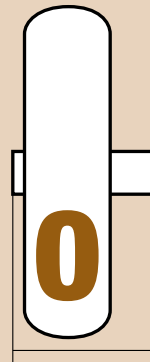

An offset hub allows for versatile uses, with different spacing from the wheel center to mounting points.

T CAUTION:  ALL replacement wheels and tires are **NOT** intended for highway use.

T CAUTION:  Before using pneumatic wheels:
 • Inflate with hand pump only
 • Do not over inflate

TREAD SYMBOLS	TREAD	BEARING SYMBOLS	TYPE
◆◆◆	DIAMOND	●	BALL
≡	GEAR	⊠	GRAFOIL
	RIBBED	—	NO BEARING
⚡	SAWTOOTH		
■	SOLID		

HARD RUBBER

Hard rubber wheels with smooth rolling ball bearing hubs for hand trucks and equipment.



SKU NUMBER	MARKETS AVAILABLE	UPC (0 39003)	WHEEL TREAD	BEARING TYPE	BORE DIAMETER	HUB POSITION		HUB LENGTH	WHEEL DIAMETER	WHEEL WIDTH	LOAD CAPACITY	UNIT	CRTN QTY
						CENTER	OFFSET						
9600	ALL	09600 0		●	5/8"		✓	2-1/4"	8"	2-1/2"	250	1	4
9602	ALL	09602 4		●	5/8"		✓	2-1/4"	10"	2-1/2"	300	1	4
9704	ALL	09704 5	⚡	●	5/8"		✓	2-1/4"	10"	3"	300	1	4
9653	USA ONLY	09653 6		●	3/4"	✓		3-1/4"	12"	2-5/8"	300	1	4
9654	USA ONLY	09654 3		●	5/8"	✓		3-1/4"	12"	2-5/8"	300	1	4

SEMI-PNEUMATIC

Hard rubber semi-pneumatic wheels with durable metal hubs and various tread patterns for lawn and garden equipment.



SKU NUMBER	MARKETS AVAILABLE	UPC (0 39003)	WHEEL TREAD	BEARING TYPE	BORE DIAMETER	HUB POSITION		HUB LENGTH	WHEEL DIAMETER	WHEEL WIDTH	LOAD CAPACITY	UNIT	CRTN QTY
						CENTER	OFFSET						
9589	ALL	09589 8	◆◆◆	⊠	1/2"		✓	1-3/8"	6"	1-1/2"	88	1	12
9590	ALL	09590 4		—	1/2"	✓		1-1/2"	6"	1-1/2"	66	1	12
9591	ALL	09591 1	◆◆◆	—	1/2"	✓		1-1/2"	6"	1-1/2"	88	1	12
9703	CANADA ONLY	09703 8	◆◆◆	—	1/2"		✓	1-3/8"	6"	1-3/4"	85	1	12
3339	USA ONLY	03339 5		—	5/8"		✓	2-1/4"	7"	1-1/2"	300	1	12
9592	ALL	09592 8	◆◆◆	—	1/2"	✓		2"	7"	1-1/2"	88	1	12
9593	USA ONLY	09593 5	◆◆◆	⊠	1/2"		✓	1-3/8"	7"	1-1/2"	88	1	12
9702	ALL	09702 1		—	1/2"	✓		1-1/2"	7"	1-1/2"	85	1	12
3355	USA ONLY	03355 5	≡	—	1/2"		✓	1-1/2"	8"	1-3/4"	55	1	12
9594	ALL	09594 2	◆◆◆	●	1/2"	✓		2"	8"	1-3/4"	88	1	12
9595	USA ONLY	09595 9	≡	—	1/2"	✓		1-3/8"	8"	1-3/4"	88	1	12
9599	ALL	09599 7	◆◆◆	⊠	1/2"		✓	1-3/8"	8"	1-3/4"	88	1	12
9636	USA ONLY	09636 9		—	1/2"	✓		2"	8"	1-3/4"	88	1	12
9596	ALL	09596 6		—	1/2"	✓		1-1/2"	10"	1-3/4"	110	1	6
9597	ALL	09597 3		—	5/8"	✓		2-3/4"	10"	2-3/4"	175	1	6
9584	USA ONLY	09584 3		—	1/2"	✓		2-1/4"	12"	1-3/4"	110	1	6

SEMI-PNEUMATIC

Hard rubber semi-pneumatic wheels with sturdy plastic hubs and diamond tread for light outdoor applications.



SKU NUMBER	MARKETS AVAILABLE	UPC (0 39003)	WHEEL TREAD	BEARING OPTIONS	BORE DIAMETER	HUB POSITION		HUB LENGTH	WHEEL DIAMETER	WHEEL WIDTH	LOAD CAPACITY	UNIT	CRTN QTY
						CENTER	OFFSET						
9610	ALL	09610 9	◆◆◆	—	1/2"		✓	1-1/2"	6"	1-1/2"	30	1	12
9611	ALL	09611 6	◆◆◆	—	1/2"		✓	1-1/2"	7"	1-1/2"	30	1	12
9613	ALL	09613 0	◆◆◆	—	1/2"		✓	1-1/2"	8"	1-3/4"	45	1	12
9615	ALL	09615 4	◆◆◆	—	1/2"		✓	1-1/2"	10"	1-3/4"	60	1	6

FLAT FREE

Foam-filled **flat free** wheels never require maintenance or air and are perfect for seldom used equipment and cold temperatures.



SKU NUMBER	MARKETS AVAILABLE	UPC (0 39003)	WHEEL TREAD	BEARING TYPE	BORE DIAMETER	HUB POSITION		HUB LENGTH	WHEEL DIAMETER	WHEEL WIDTH	LOAD CAPACITY	UNIT	CRTN QTY
						CENTER	OFFSET						
9709	ALL	09709 0		●	Universal	✓		3"	14"	3-1/8"	400	1	4
9708	USA ONLY	09708 3		●	5/8"	✓		6"	15"	3-3/4"	500	1	4

- Provides an air like ride, but can withstand all the common objects that typically cause flats.
- Lasts 4 to 10 times longer than standard air-filled tires.

PNEUMATIC

Air-filled **pneumatic** wheels with smooth rolling ball bearing hubs for carts and wagons.



SKU NUMBER	MARKETS AVAILABLE	UPC (0 39003)	WHEEL TREAD	BEARING TYPE	BORE DIAMETER	HUB POSITION		HUB LENGTH	WHEEL DIAMETER	WHEEL WIDTH	LOAD CAPACITY	UNIT	CRTN QTY
						CENTER	OFFSET						
3335	USA ONLY	03335 7	⚡	●	5/8"		✓	2-1/4"	10"	4"	400	1	6
9634	ALL	09634 5	⚡	●	5/8"		✓	2-1/4"	10"	3"	350	1	4
9793		09793 9	⚡	●	5/8"	✓		4"	10"	3-1/2"	220	1	4

WHEELBARROW

Inner tubes, tubeless tires, pneumatic and flat free wheels to keep your **wheelbarrow** in operation.



Tubeless 3336



Inner Tube 3332

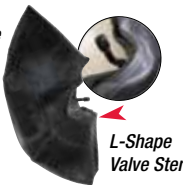

L-Shape Valve Stem



SKU NUMBER	MARKETS AVAILABLE	UPC (0 39003)	WHEEL TREAD	BEARING TYPE	BORE DIAMETER	HUB POSITION		HUB LENGTH	WHEEL DIAMETER	WHEEL WIDTH	LOAD CAPACITY	UNIT	CRTN QTY
						CENTER	OFFSET						
9606	ALL	09606 2		●	5/8"	✓		6"	16"	3-1/4"	300	1	1
3336	USA ONLY	03336 4			5/8"	✓		6"	16"	4"	500	1	6
9708	USA ONLY	09708 3		●	5/8"	✓		6"	15"	3-3/4"	500	1	4
9709	ALL	09709 0		●	Universal	✓		3"	14"	3-1/8"	400	1	4
3337	USA ONLY	03337 1			5/8"	✓		3"	14"	3-1/8"	300	1	6
3332	USA ONLY	03332 6	—	—	—	—	—	—	—	—	—	1	6



MATERIAL HANDLING

MoveIT products were designed with the consumer in mind. Non-marking, ball-bearing swivel casters are consistent throughout the line-up, with other conveniences such as padded non-slip surfaces and integrated handles. Movers blankets offer padded protection and have countless uses.



Home Series

- Wooden Dollies
- Steel Tri-Dollies
- Platform Cart

Premier Series

- Platform Carts
- Wooden Dollies
- Movers Blankets

MOVE IT

shepherd
HARDWARE PRODUCTS



MOVE IT HOME SERIES

Home Series for standard household use

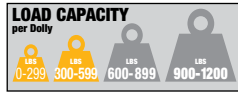

MOVE IT PREMIER SERIES

Premier Series are ideal for heavy-duty use



	DESCRIPTION	SKU	MARKETS AVAILABLE	DOLLY	W/STAIR CART	WHEEL DIAMETER	UPC (0 39003)	PLATFORM SHAPE	PLATFORM DIMENSIONS			LOAD CAPACITY	PIECES PER PKG	CARTON PACK QUANTITY
									LENGTH	WIDTH	DEPTH			
HOME SERIES	Solid wooden platforms with durable Polyurethane swivel casters and integrated handles	3360	USA ONLY	✓		1-1/4"	03360 9	▼	5"	5"	2-1/4"	220	1	40
		3366	ALL	✓		3"	03366 1	■	23-1/4"	19"	4-1/4"	397	4	4
		3367	ALL	✓		3"	03367 8	■	24"	12"	4-1/4"	397	4	4
		3368	ALL	✓		3"	03368 5	●	15"	15"	4-1/4"	397	4	4
	Steel tri-dollies are convenient for multiple applications with triple Polypropylene swivel casters, padded bases, center mounting hole and low-profile stance	9283	ALL	✓		1-1/4"	09283 5	▼	4"	4"	2"	200	1	6
		9299	ALL	✓		1-1/4"	09299 6	▼	6"	6"	2"	200	6	48
		9442	ALL	✓		2"	09442 6	▼	12"	12"	2"	300	6	48
	Welded steel platform carts with reinforced handles that fold for storage	9847	ALL	✓		4"	09847 9	■	29"	19"	—	330	1	1
		9846	ALL	✓		5"	09846 2	■	36"	24"	—	600	1	1
	Polypropylene platform cart with folding handle	3354	USA ONLY	✓		5"	03354 8	■	36"	24"	35"	661	1	1
PREMIER SERIES	Solid wooden platforms with durable Polyurethane swivel casters, non-slip coating, and integrated handles	3361	ALL	✓		4"	03361 6	■	23-1/4"	19-3/8"	5-7/8"	882	1	4
		3362	USA ONLY	✓		3"	03362 3	■	23-5/8"	11-3/4"	4-1/2"	529	1	4
		3363	USA ONLY	✓		3"	03363 0	●	15"	15"	4-1/2"	529	1	4
	Carpet-covered wooden dollies with Polyurethane (3365) and Hard Rubber (9850) swivel casters	3365	ALL	✓		4"	03365 4	■	18"	12"	—	840	1	4
		9850	ALL	✓		3"	09850 9	■	29-3/4"	18"	5-3/8"	840	1	4
	Solid wood plant dolly with Hard Rubber swivel casters	9854	ALL	✓		3"	09854 7	■	18"	12"	—	360	1	5
Large padded movers blanket - Blue	89851	ALL	—	—	—	89851 2	■	80"	72"	—	—	4	5	

FELT

Shepherd Hardware is the recognized North American leader in felt floor protection. Felt allows for discreet scratch-free motion over wood, tile, and laminate floors, but can also be added to countless surfaces as a buffer and barrier at your home, the office or your vehicle.



Expanded product line for improved performance, especially in specialized conditions

COMMERCIAL GRADE FELT

Polyester and wool blend with extra aggressive adhesive for the toughest applications

30

FELTGARD

Extra-dense hardened polyester for heavy-duty performance

31

FELTGARD PLUS

Nail-on, screw-on, threaded and other attachments for the trickiest installs or security beyond adhesives

32

ECLIPSE FELT

Unique domed shape designed for travel across grout and uneven floor surfaces

33

WOOD AND
HARD FLOORS



shepherd
HARDWARE PRODUCTS

T

TIPS:

Felt is great for behind the desk, the rear of the headboard, and in the sound dampening of cupboards. Use beneath countertop appliances, housewares, lamps and as a quick fix to anything that rattles.

For a stronger bond apply pressure during installation. Sitting on a chair is an easy way to apply pressure. Allow extra set-up time to enhance the bond.

Shepherd Felt Pads have been developed with durable and reliable combinations of materials and adhesives. These combinations have proven to stick very well over time and with use, but...

Surface Prep is Key

All surfaces should be clean and smooth.....



- Use isopropyl alcohol to remove any old adhesive remaining on surfaces.



- Use sandpaper to smooth rough or dirty surfaces.



- Remove sawdust or other debris and allow surface to dry completely before applying felt pads.



- Peel and stick.



- Repeat until all legs are prepped and pads placed in position.

Sticking Around

Shepherd Hardware self adhesive felt has been designed and refined over the years to maintain performance. Our most basic, SurfaceGard products are recommended for household uses such as under counter top decorations where there is little weight or movement. Industry-leading FeltGard pads are thicker and hardened, with a stronger adhesive to perform very well on chairs and other furniture. Newer to the market, Commercial Grade felt boasts a super-aggressive adhesive and soft synthetic / wool blend for superior strength and durability. Eclipse domed felt pads are backed with our strongest adhesive for improved performance over grout and uneven floors.



Felt Pad Adhesion Test Ratings



Shear Force to Dislodge a Felt Pad



What makes this **COMMERCIAL GRADE FELT?**



Robust polyester is mated with natural wool to create a durable and ultra-strong yet soft felt blend.



Extensively tested and refined adhesive delivers maximum holding power

Stiff polyester layer maintains rigidity

Dense interwoven wool layer is gentle on floors

COMMERCIAL GRADE EXTRA HEAVY-DUTY FELT



SKU	MARKETS AVAILABLE	DESCRIPTION	UPC (0 39003)	PAD COLOR & SHAPE	PAD DIMENSIONS	PIECES PER CARD	CARTON PACK QTY
6705	ALL	Round Felt Pads	06705 5	○	3/4"	20	12
6706	ALL	Round Felt Pads	06706 2	○	1"	16	12
6707	ALL	Round Felt Pads	06707 9	○	1-1/2"	8	12
6708	ALL	Round Felt Pads	06708 6	○	1"	48	6
6709	ALL	Round Felt Pads	06709 3	○	1"	96	4
6710	ALL	Felt Roll	06710 9	●	1/2" x 58"	1	12



Commercial Grade Felt is designed to offer the strongest bond possible when properly installed on furniture.

2X ✓ DURABILITY
✓ ADHESION

For more information, visit www.shepherdhardware.com/commercialfelt



HEAVY DUTY FELT

Heavy duty self-adhesive pads are simple to install and designed to provide unmatched protection to furniture and surfaces such as hardwood, linoleum, vinyl, terrazzo, marble, etc. Available in either beige or brown to compliment light or dark wood finishes and are in the most popular sizes and shapes. **Self-leveling** pads are ideal for angled leg chairs. Thick foam layer allows for superior surface adhesion and grip. Corrects uneven wear of 3/8" or less on chairs and stools.









SKU	MARKETS AVAILABLE	DESCRIPTION	UPC (0 39003)	PAD SHAPE & COLOR	SIZE	PIECES PER CARD	CARTON PACK QUANTITY
BEIGE HEAVY-DUTY FELT							
9951	ALL	Round Felt Pads	09951 3	●	3/4"	20	12
9952	ALL	Round Felt Pads	09952 0	●	1"	16	12
9972	ALL	Round Felt Pads	09972 8	●	1"	48	6
9953	ALL	Round Felt Pads	09953 7	●	1-1/2"	8	12
9976	ALL	Round Felt Pads	09976 6	●	1-1/2"	24	6
9927	ALL	Round Felt Pads	09927 8	●	2"	4	6
9928	ALL	Round Felt Pads	09928 5	●	3"	4	6
9921	ALL	Round Felt Pads	09921 6	●	4"	4	6
9815	ALL	Square Felt Pads	09815 8	■	1"	16	12
9844	ALL	Rectangle Felt Pads	09844 8	▭	1" x 3-3/4"	4	12
9948	USA ONLY	Rectangle Felt Pads	09948 3	▭	2" x 4"	3	12
9950	ALL	Rectangle Felt Blankets	09950 6	▭	4-1/4" x 6"	2	12
9937	ALL	Rectangle Felt Strips	09937 7	▭	1/2" x 2-5/8"	16	12
9954	ALL	Rectangle Felt Strips	09954 4	▭	1/2" x 6"	9	12
9818	ALL	Felt Roll	09818 9	🌀	1/2" x 58"	1	12
9816	ALL	"L" Shape Felt Pads	09816 5	└	1-1/2" x 1-1/2"	8	12
BROWN HEAVY-DUTY FELT							
9861	ALL	Round Felt Pads	09861 5	●	3/4"	20	12
9862	ALL	Round Felt Pads	09862 2	●	1"	16	12
9873	ALL	Round Felt Pads	09873 8	●	1"	48	6
9863	ALL	Round Felt Pads	09863 9	●	1-1/2"	8	12
9877	ALL	Round Felt Pads	09877 6	●	1-1/2"	24	6
9867	ALL	Round Felt Pads	09867 7	●	2"	4	6
9868	ALL	Round Felt Pads	09868 4	●	3"	4	6
9864	ALL	Square Felt Pads	09864 6	■	1"	16	12
9860	ALL	Rectangle Felt Blankets	09860 8	▭	4-1/4" x 6"	2	12
9865	ALL	Rectangle Felt Strips	09865 3	▭	1/2" x 2-5/8"	16	12
SELF-LEVELING							
9915	ALL	Round Felt Pads	09915 5	●	1"	8	6
9916	ALL	Round Felt Pads	09916 2	●	1-1/2"	4	6
HEAVY-DUTY FELT VALUE PACKS							
9913	CANADA ONLY	Round Felt Pads - Dinette Set 16 - 1" Round Pads 4 - 1-1/2" Round Pads	09913 1	● ●	1" 1-1/2"	20 16 4	12
9947	ALL	Felt Pad Assortment 1 - 4-1/4" x 6" Blanket 10 - 3/4" Round Pads 8 - 1" Round Pads 4 - 1-1/2" Round Pads 4 - 1/2" x 6" Strips	09947 6	▭ ● ● ● ▭	4-1/4" x 6" 3/4" 1" 1-1/2" 1/2" x 6"	27 1 10 8 4 4	12
6730	ALL	Felt Pad Bagged Assortment-Beige 24 - 1-1/2" Round Pads 48 - 1" Round Pads 10 - 3/4" Round Pads	06730 7	●	1-1/2" 1" 3/4"	82 24 48 10	12
6731	ALL	Felt Pad Bagged Assortment-Brown 24 - 1-1/2" Round Pads 48 - 1" Round Pads 10 - 3/4" Round Pads	06731 4	●	1-1/2" 1" 3/4"	82 24 48 10	12
9882	ALL	Round Felt Pads in Resealable Bag	09882 0	●	1"	96	4
9852	ALL	Round Felt Pads in Resealable Bag	09862 2	●	1"	160	20

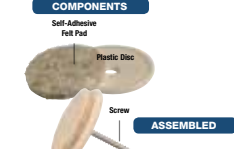

HEAVY DUTY FELT

With additional attachment options beyond self-adhesive.



	SKU	MARKETS AVAILABLE	DESCRIPTION	UPC (0 39003)	PAD SHAPE & COLOR	INSTALLATION OPTIONS				SIZE	PIECES PER CARD	CARTON PACK QUANTITY
						SELF-ADHESIVE	SCREW-IN	NAIL-ON	HOOK & LOOP			
HOLLOW NAIL FELT PADS (FOR WOODEN LEGS)												
 <p>These glides tap safely into wooden legs without splitting while the heavy duty felt base slides easily over hard surface floors that could be damaged by other types of glides.</p>	9933	ALL	Hollow Nail Felt Pads	09933 9				✓		7/8"	4	6
	9934	ALL	Hollow Nail Felt Pads	09934 6				✓		1"	8	12
	9935	ALL	Hollow Nail Felt Pads	09935 3				✓		1-1/2"	4	12
	9936HS	USA ONLY	Hollow Nail Dinette Set 16 - 1" Round Pads 4 - 1-1/2" Round Pads	09936 0				✓		1" 1-1/2"	20 16 4	12
	9936	CANADA ONLY	Hollow Nail Dinette Set 16 - 1" Round Pads 4 - 1-1/2" Round Pads	09936 0				✓		1" 1-1/2"	20 16 4	12
STRAIGHT NAIL FELT PADS (FOR WOODEN LEGS)												
 <p>These glides often require a pre-drilled starter hole to avoid splitting and are NOT intended for angled chair legs.</p>	9955	ALL	Nail-On Plastic Bases w/ Felt Pads	09955 1				✓		1-1/8"	16	6
	9910	CANADA ONLY	Nail-On Felt Pads	09910 0				✓		7/8"	8	12
	9911	CANADA ONLY	Nail-On Felt Pads	09911 7				✓		1-1/2"	4	12
	9918	CANADA ONLY	Nail-On Felt Pads	09918 6				✓		1"	8	12
	9938	ALL	Brass Swivel Glides	09938 4				✓		1"	4	6
	9939	CANADA ONLY	Nail-On Felt Pads Combo 16 - 1" Round Pads 4 - 1-1/2" Round Pads	09939 1				✓		1" 1-1/2"	4	12
SCREW-ON FELT PADS WITH NYLON INSERTS												
 <p>Attach nylon base to furniture with included screws before placement of self-adhesive pad.</p>	9819	ALL	Felt Pads	09819 6		✓	✓			1"	8	12
	9832	ALL	Felt Pads	09832 5		✓	✓			3/4"	8	12
SCREW-ON FELT PADS WITH NYLON INSERTS - INCLUDES DRILL BIT & SCREW-NAILS												
 <p>Use included drill bit for a starter hole, then attach nylon base to furniture with ingenious screw-nails. Carefully tap screw-nail flush before placement of self-adhesive pad.</p>	9840	ALL	Felt Pads	09840 0		✓	✓	✓		3/4"	8	6
	9841	ALL	Felt Pads	09841 7		✓	✓	✓		1"	8	6
	9842	ALL	Felt Pads	09842 4		✓	✓	✓		1-1/2"	4	6
	9843	ALL	Value Pack Combo 16 - 1" Round Pads 4 - 1-1/2" Round Pads	09843 1		✓	✓	✓		1" 1-1/2"	20 16 4	4
	9845	USA ONLY	Heavy Duty Felt Pads	09845 5		✓	✓	✓		1" x 3-3/4"	4	6
SCREW-ON FELT PADS												
 <p>These pads are permanently attached to rubber bases for long-term performance. Pre-drill and fully bury screw head to avoid floor damage.</p>	9824	CANADA ONLY	Felt Pad Combo Combined 9825 + 9826	09824 0				✓		1" 1-1/2"	20 16 4	6
	9825	ALL	Felt Pads	09825 7				✓		1"	4	6
	9826	ALL	Felt Pads	09826 4				✓		1-1/2"	4	6
	9827	ALL	Felt Pads	09827 1				✓		2"	4	4
	9828	ALL	Felt Pads	09828 8				✓		2-1/2"	4	6
	9829	USA ONLY	Felt Pads	09829 5				✓		1-1/2"	4	6
THREADED STEM FELT PADS												
 <p>Thread felt glide screws into included socket for customized leveling. Pre-drill 11/32" diameter hole 1" into wooden leg to securely position plastic socket.</p>	9908	USA ONLY	Threaded Stem Felt Pads	09908 7				✓		1"	4	6
	9909	USA ONLY	Threaded Stem Felt Pads	09909 4				✓		1-1/2"	4	6
FELT WITH HOOK & LOOP												
 <p>Hook & loop pads are specially designed for hard to attach applications on furniture where standard felt fails. Everything necessary for easy installation provided.</p>	9931	CANADA ONLY	Hook & Loop Felt Pads	099315		✓			✓	3/4"	20	6
	9930	CANADA ONLY	Hook & Loop Felt Pads	09930 8		✓			✓	1"	16	6
	9892	CANADA ONLY	Hook & Loop Felt Pads	09882 9		✓			✓	1-1/2"	4	6

HEAVY DUTY FELT SNAP-ON/SNAP-OFF PADS

Snap-On/Snap-Off felt caps allow for ultra-quick replacement when worn. Safe hollow nail attachment of base will not split wooden legs and never needs replaced. Replacement pads are available and sold separately.



SKU	MARKETS AVAILABLE	DESCRIPTION	UPC (0 39003)	SHAPE	INSTALLATION		SIZE	PIECES PER CARD	CARTON PACK QUANTITY
					HOLLOW NAIL-ON	SNAP-ON			
3633	ALL	Snap-On/Snap-Off Base + Felt Pad	03633 4	○	✓	✓	7/8"	8/8	6
3634	ALL	Snap-On/Snap-Off Base + Felt Pad	03634 1	○	✓	✓	1"	8/8	6
3635	ALL	Snap-On/Snap-Off Base + Felt Pad	03635 8	○	✓	✓	1-1/2"	4/4	6
3636	ALL	Replacement Felt Pads only	03636 5	○		✓	7/8"	8	6
3637	ALL	Replacement Felt Pads only	03637 2	○		✓	1"	8	6
3638	ALL	Replacement Felt Pads only	03638 9	○		✓	1-1/2"	4	6



Hollow nail tap-in base with replaceable felt pads provide superior holding strength on wood furniture

ECLIPSE FELT

Heavy duty pads are designed to slide over uneven surfaces. Traditional products have been eclipsed by new heavy duty FeltGard pads with a unique domed shape to effectively navigate across uneven surfaces. Coupled with extra-strength adhesive, these new pads ensure superior long-lasting performance and floor protection.



SKU	MARKETS AVAILABLE	DESCRIPTION	UPC (0 39003)	SHAPE	SELF-ADHESIVE	SIZE	PIECES PER CARD	CARTON PACK QUANTITY
6720	ALL	Domed Felt Pads	06720 8	○	✓	1"	16	12
6721	ALL	Domed Felt Pads	06721 5	○	✓	1"	48	6



Unique Dome Shape



6720: 16 pcs = 4 chairs

6721: 48 pcs = larger projects

STORE & REUSE MOVERS PADS & SLIDERS

Intended for temporary or long-term use, these convenient products are placed under heavy furniture to allow for easy sliding. One person can safely rearrange or clean behind furniture while protecting carpet and floors.

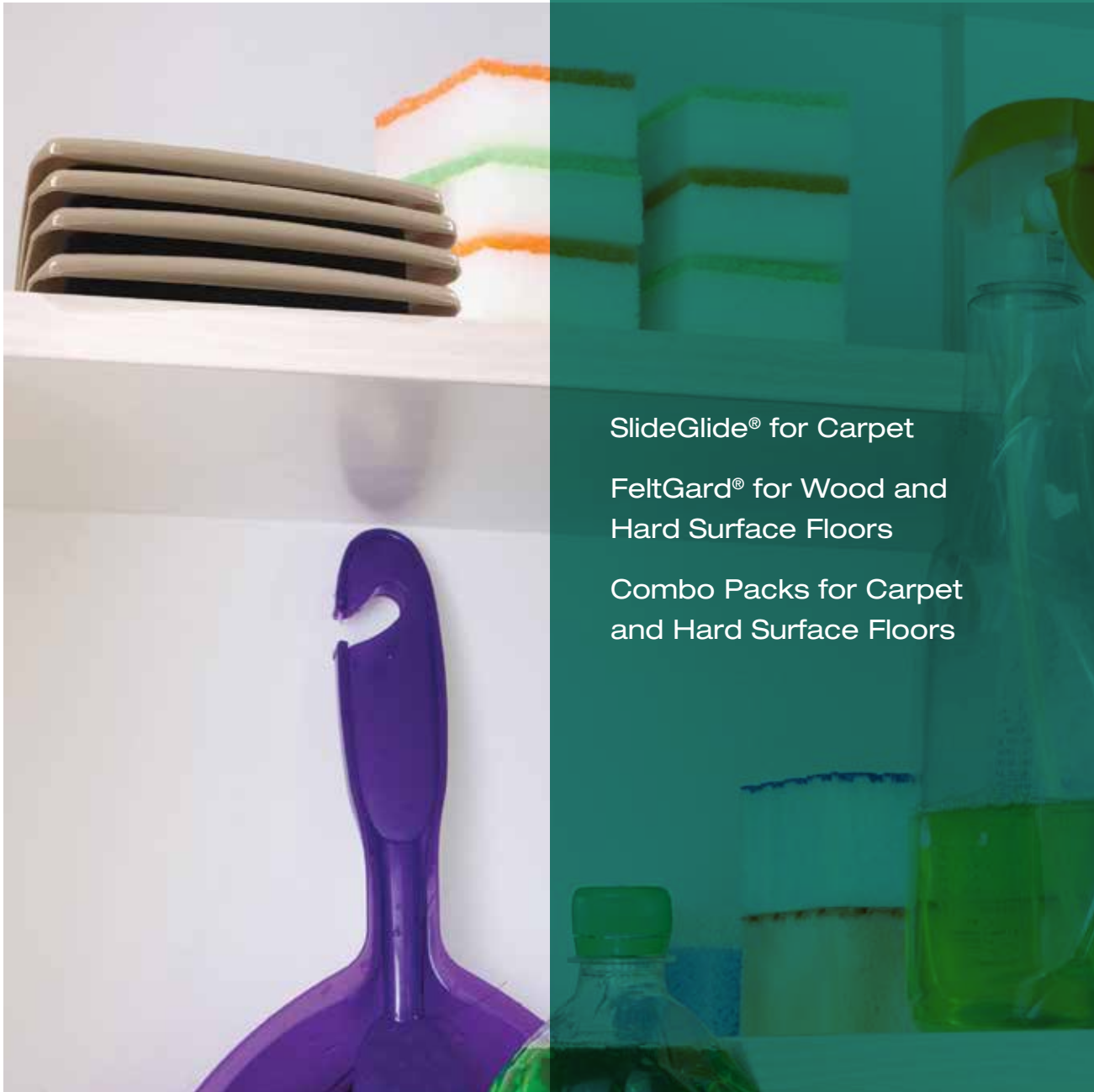

SlideGlide® for Carpet

FeltGard® for Wood and
Hard Surface Floors

Combo Packs for Carpet
and Hard Surface Floors

SLIDEGLIDE⁺
Slide objects easily

**FELT
GARD**
Plus

shepherd
HARDWARE PRODUCTS

STORE & REUSE MOVERS PADS & SLIDERS

Intended for temporary or long-term uses, store and reuse products have a cushioned side for furniture contact and either a heavy-duty felt side for wood and hard surface floors or a smooth plastic side for sliding over carpet. **SlideGlide**® pads significantly reduce the friction between heavy furniture and carpet for easy and safe movement with little effort. **FeltGard**® pads allow for safe and easy movement of furniture over wood and other hard surface floors. **Movers pads** are reinforced and sturdier for daily use.



**Movers Pads
Protect All Types
of Floor Surfaces
from Damage and
Scratches!**



SKU NUMBER	MARKETS AVAILABLE	DESCRIPTION	UPC (0 39003)	PAD SHAPE	SIZE	PIECES PER CARD	CARTON PACK QUANTITY
SLIDEGLIDE® MOVERS PADS FOR CARPET							
9335	USA ONLY	Square Black Movers Pads	09335 1	■	3"	4	6
9336	ALL	Square Almond Movers Pads	09336 8	■	3"	4	6
9337	USA ONLY	Square White Movers Pads	09337 5	■	3"	4	4
3955	USA ONLY	Round Taupe Movers Pads	03955 7	●	3-1/2"	4	4
9316	ALL	Round Taupe Sliders	09316 0	●	4"	4	4
9314	ALL	Round Taupe Sliders + Socks 4 – Round Taupe Sliders 4 – Round Fleece Socks	09314 6	●	5"	8	4
3956	USA ONLY	Square Taupe Movers Pads	03956 4	■	5"	4	4
9338	ALL	Rounded Taupe Movers Pads	09338 2	■	5-1/2" x 8"	4	3
3957	USA ONLY	Value Pack 8 – Round Taupe Movers Pads	03957 1	●	3-1/2" 7"	8	4
FELTGARD® MOVERS PADS & SLIDERS FOR HARD FLOORS							
9408	ALL	Round Felt Sliders	09408 2	●	2-1/2"	4	4
9407	ALL	Round Felt Sliders	09407 5	●	3-1/2"	4	4
9140	ALL	Round Felt Sliders	09140 1	●	5"	4	4
9141	USA ONLY	Rectangular Felt Sliders	09141 8	■	2-1/2" x 9"	4	4
9142	ALL	Rounded Felt Sliders	09142 5	■	4" x 7"	4	4
9369	USA ONLY	Square Movers Pads	09369 6	■	3" x 3"	4	6
9431	USA ONLY	Rounded Movers Pads	09431 0	■	5-3/4" x 8-1/4"	4	6
MOVERS PADS COMBO PACKS FOR CARPET & HARD FLOORS							
3960	USA ONLY	4 – Round Felt Sliders 4 – Round Plastic Sliders	03690 1	●	3-1/2"	8	6
9855	ALL	4 – Round Anti-Skid Pads 4 – Round Felt Slider Pads 4 – Round Plastic Slider Pads	09855 4	●	4"	12	4
9045	USA ONLY	4 – Felt Movers 4 – Round Felt Movers 4 – Plastic Movers 4 – Round Plastic Movers	09045 9	■ ● ■ ●	4" x 7" 3-1/2" 5-3/4" x 8-1/4" 3-1/2"	16	4



Low friction sliders are placed under heavy items to allow for easy sliding across carpet. Various attachment methods are available for secure bonding to furniture.

SLIDERS



Self-Adhesive Sliders

Reinforced Sliders w/Screws

Cushioned Nail-On Sliders

Heavy-Duty Threaded Sliders

Rubber Leg Tip Sliders

Rubber Cup Sliders

SLIDEGLIDE[®]
Slide objects easily

SLIDEGLIDE⁺
Slide objects easily

shepherd
HARDWARE PRODUCTS

CARPET SLIDERS

Our sliders are molded in a special & exclusive resin that is ultra-slick with an extra-low coefficient of friction for very easy sliding on carpet. Various attachment options are available for secure bonding to furniture. **Self-adhesive** sliders are felt-backed with convenient peel and stick attachment. **Steel-reinforced** self-adhesive sliders include a pass through hole and screws for a permanent installation. Cushioned **Nail-on** sliders are nailed into wooden legs and have a forgiving & sound dampening middle layer. Heavy-duty **Threaded** sliders are hexagonally shaped and attach to appliances and furniture with a 5/16" threaded stem. Black **Rubber leg tip** sliders fit over round wooden or tubular furniture legs. Black **Rubber cup** sliders are outfitted with a round and recessed rubber pocket to accept furniture feet up to the specified inside dimensions.



SKU	MARKETS AVAILABLE	DESCRIPTION	UPC (0 39003)	PAD, TIP, & CUP SHAPE	INSTALLATION OPTIONS			SIZE	PIECES PER CARD	CARTON PACK QUANTITY
					SELF-ADHESIVE	SCREW	NAIL-ON			
SELF-ADHESIVE SLIDERS										
3943	USA ONLY	Round Pads	03943 4	●	✓			1-1/2"	4	6
3944	USA ONLY	Round Pads	03944 1	●	✓			2"	4	6
3951	ALL	Dinette Set 16 – Round Pads 4 – Round Pads	03951 9	●	✓			1" 1-3/4"	20	6
3949	ALL	Square Pads	03949 6	■	✓			2"	4	6
9241	ALL	Rectangular Pads	09241 5	▬	✓			1" x 4"	4	6
9457	USA ONLY	Oblong Pads	09457 0	▬	✓			5/8" x 3"	4	6
REINFORCED SELF-ADHESIVE SLIDERS WITH SCREWS										
9456	ALL	Round Pads w/Screws	09456 3	●	✓	✓		7/8"	8	6
9452	ALL	Round Pads w/Screws	09452 5	●	✓	✓		1"	8	6
9455	ALL	Round Pads w/Screws	09455 6	●	✓	✓		1-1/2"	4	6
9453	ALL	Round Pads w/Screws	09453 2	●	✓	✓		2"	4	6
9454	ALL	Round Pads w/Screws	09454 9	●	✓	✓		2-1/2"	4	6
9248	ALL	Round Pads w/Screws	09248 4	●	✓	✓		2-3/4"	4	6
9471	USA ONLY	Dinette Set w/Screws 16 – 1" Round Pads 4 – 1-1/2" Round Pads	09471 6	●	✓	✓		1" 1-1/2"	20 16 4	6
9243	ALL	Triangle Pads w/Screws	09243 9	▼	✓	✓		2" x 2" x 2-1/2"	4	6
9240	USA ONLY	Square Pads w/Screws	09240 8	■	✓	✓		1"	8	6
9242	USA ONLY	Square Pads w/Screws	09242 2	■	✓	✓		1-3/8"	4	6
9244	ALL	Square Pads w/Screws	09244 6	■	✓	✓		2-1/8"	4	6
CUSHIONED NAIL-ON SLIDERS										
9469	ALL	Round Nail-On Pads	09469 3	●			✓	7/8"	8	6
9249	ALL	Round Nail-On Pads	09249 1	●			✓	1-1/4"	4	6
HEAVY-DUTY THREADED APPLIANCE SLIDERS										
9468	ALL	Threaded Hexagonal Pads	09468 6	⬡		5/16"		1-1/2"	4	4
BLACK RUBBER LEG TIP SLIDERS										
9219	USA ONLY	Round Rubber Leg Tips	09219 4	●	—	—	—	1"	4	6
9220	USA ONLY	Round Rubber Leg Tips	09220 0	●	—	—	—	1-1/8"	4	6
BLACK RUBBER CUP SLIDERS										
9221	ALL	Cups	09221 7	●	—	—	—	1-3/4" I.D.	4	6
9222	ALL	Cups	09222 4	●	—	—	—	2-3/4" I.D.	4	4

TIP: Surface prep is key in the performance of self-adhesive pads. See page 29 for detailed cleaning recommendations.

TIP: Pre-drill small pilot holes into wooden legs to avoid splitting during the installation of screws and nail-on sliders.

FURNITURE CUPS

Cups provide a stable non-marking base for furniture feet and come in a variety of materials and finishes for hard and carpeted surfaces.



Carpet Base Metal

Clear Spiked Plastic

Clear Smooth Plastic

Smooth Rubber

Woodgrain Plastic

CARPET BASE METAL

Rigid metal cups with carpeted underside for contact with hard surface floors.



SKU	MARKETS AVAILABLE	CUP BASE TYPE	UPC (0 39003)	CUP COLOR & SHAPE	INNER DIMENSION	PIECES PER CARD	CARTON PACK QUANTITY
9079	USA ONLY	Round Carpet Base	09079 4	●	1-5/8"	4	6
9091	ALL	Round Carpet Base	09091 6	●	1-3/4"	4	6
9090	ALL	Round Carpet Base	09090 9	●	2"	4	6
9092	ALL	Round Carpet Base	09092 3	●	2-1/2"	2	6
9080	ALL	Square Carpet Base	09080 0	■	1-1/2"	4	6

CLEAR PLASTIC

Colorless to blend into carpet while protecting against wear and pile. Spiked design grips carpet and smooth can be used on some hard surfaces.



	SKU	MARKETS AVAILABLE	UPC (0 39003)	CLEAR CUP SHAPE	INNER DIMENSION	PIECES PER CARD	CARTON PACK QUANTITY
SPIKED	9081	ALL	09081 7	○	1-1/2"	4	6
	9082	ALL	09082 4	○	1-7/8"	4	6
	9083	ALL	09083 1	□	1-7/8"	4	6
SMOOTH	9087	ALL	09087 9	○	1-3/8"	4	6
	9088	ALL	09088 6	○	1-7/8"	4	6
	9089	ALL	09089 3	□	1-7/8"	4	6

RUBBER

Solid rubber off-white or brown blocks with recessed pockets to fit furniture feet and protect hard surface floors.



SKU	MARKETS AVAILABLE	UPC (0 39003)	CUP COLOR & SHAPE	INNER DIMENSION	PIECES PER CARD	CARTON PACK QUANTITY
9165	USA ONLY	09165 4	○	1-1/2"	4	6
9167	ALL	09167 8	○	1-3/4"	4	6
9068	ALL	09068 8	○	3"	2	6
9166	ALL	09166 1	□	2"	4	6
9168	ALL	09168 5	□	3"	2	6
9075	ALL	09075 6	●	1-1/2"	4	6
9077	ALL	09077 0	●	1-3/4"	4	6
9067	ALL	09067 1	●	3"	2	6
9074	ALL	09074 9	■	1-5/8"	4	6
9076	ALL	09076 3	■	2"	4	6
9078	ALL	09078 7	■	3"	2	6

WOODGRAIN PLASTIC

Round cups that imitate woodgrain and protect with non-slip TPR or felt undersides for contact with hard surface floors.



	SKU	MARKETS AVAILABLE	UPC (0 39003)	CUP SHAPE	INNER DIMENSION	PIECES PER CARD	CARTON PACK QUANTITY
TPR	9058	ALL	09058 9	●	2-3/8"	4	6
FELT	9363	ALL	09363 4	●	1-3/4"	4	6
	9364	ALL	09364 1	●	2-3/8"	4	4

ANTI-SKID

Anti-skid products protect hard surfaces and floors while holding furniture and other items in place. Self-adhesive and heavy-duty screw-in attachment options both offer sound and vibration dampening benefits. Cups and dual-function Slider 'n Gripper items complete the category.



Self-Adhesive Pads

Heavy-Duty Screw-In Pads

Slider 'n Gripper Pads & Cups



ANTI-SKID PADS

Self-adhesive anti-skid pads are applied to the underside of appliances, office equipment, or furniture to minimize motion and protect counter tops while offering sound and vibration dampening benefits. **Thinner** pads offer the same benefits with a more subtle, lower profile. **Heavy-duty** anti-skid pads are round vinyl-coated and steel reinforced pads that are screwed into the underside of furniture to minimize movement and protect hard surface floors while offering sound and vibration dampening benefits. To avoid splitting wood, pre-drill and use included screws.

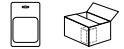

SKU	MARKETS AVAILABLE	DESCRIPTION	UPC (0 39003)	PAD SHAPE	INSTALLATION		SIZE	PIECES PER CARD	CARTON PACK QUANTITY
					SELF-ADHESIVE	SCREWS INCLUDED			
3601	ALL	Round Anti-Skid Pads	03601 3	●	✓		3/4"	20	6
3602	ALL	Round Anti-Skid Pads	03602 0	●	✓		1"	16	6
3603	ALL	Round Anti-Skid Pads	03603 7	●	✓		1-1/2"	8	6
9970	USA ONLY	Thinner Self-Adhesive Anti-Skid Pads	09970 4	●	✓		1-1/2"	8	12
3627	USA ONLY	Round Anti-Skid Pads	03627 3	●	✓		2"	4	6
9971	USA ONLY	Thinner Self-Adhesive Anti-Skid Pads	09971 1	●	✓		2"	8	12
3608	ALL	Round Anti-Skid Pads	03608 2	●	✓		2-1/2"	4	6
3628	ALL	Round Anti-Skid Pads	03628 0	●	✓		3"	4	6
3624	ALL	Rectangle Anti-Skid Pads	03624 2	■	✓		1" x 3-3/4"	4	6
3598	USA ONLY	Rectangle Anti-Skid Pads	03598 6	■	✓		2" x 4"	3	6
3600	USA ONLY	Rectangle Anti-Skid Blankets	03600 6	■	✓		4-1/4" x 6"	2	6
3615	USA ONLY	Square Anti-Skid Pads	03615 0	■	✓		1"	16	6
3616	ALL	L-Shape Anti-Skid Pads	03616 7	L	✓		1-1/2" x 1-1/2"	8	6
HEAVY-DUTY SCREW-IN PADS									
⚠ 9644	ALL	Heavy-Duty Screw-In Anti-Skid Pads	09644 4	●		✓	1"	4	6
⚠ 9645	ALL	Heavy-Duty Screw-In Anti-Skid Pads	09645 1	●		✓	1-1/2"	4	6
⚠ 9646	ALL	Heavy-Duty Screw-In Anti-Skid Pads	09646 8	●		✓	2"	4	6
⚠ 9647	ALL	Heavy-Duty Screw-In Anti-Skid Pads	09647 5	●		✓	2-1/2"	4	6

⚠ **WARNING: Cancer** — www.P65Warnings.ca.gov.

SLIDER 'n GRIPPER

SLIDER 'n GRIPPER

Dual function **Slider 'n Gripper** are self-adhesive and screw-in woodgrain plastic bases with non-skid rubber rings to minimize furniture motion when positioned on hard surface floors and move easily and safely when tilted to slide on the hard plastic shell. **Sliders** are self-adhesive and screw-in woodgrain plastic bases that allow for safe and easy sliding on hard surface floors. 3/4" diameter design includes a snap-in slide, while the slide is integrated in the 1" diameter version. **Grippers** are woodgrain plastic bases and cups with non-skid rubber underside rings to minimize furniture motion on hard surface floors. Cups offer a concave nest that cradles bed frames, casters, or furniture feet.



TIP:
Screw-in Sliders 'n Grippers are not intended for use on angled legs.



DESCRIPTION	SKU	MARKETS AVAILABLE	UPC (0 39003)	SHAPE	CUP	GLIDE	PAD	INSTALLATION		FUNCTIONS		SIZE	PIECES PER CARD	CARTON PACK QUANTITY
								SELF-ADHESIVE	SCREWS INCLUDED	GRIPPS	SLIDES			
SLIDERS + GRIPPERS	3693	USA ONLY	03693 8	●			✓	✓	✓	✓	✓	2"	4	6
	3687	USA ONLY	03687 7	●			✓	✓	✓	✓	✓	3-1/4"	4	4
SLIDERS	3694	USA ONLY	03694 5	●		✓		✓	✓		✓	3/4"	16	6
	3691	USA ONLY	03691 4	●		✓		✓	✓		✓	1"	8	6
GRIPPERS	3692	ALL	03692 1	●			✓	✓	✓	✓		1-1/4"	8	6
	3697	ALL	03697 6	●	✓						✓	1-3/4" I.D.	4	6
	3696	ALL	03696 9	●	✓						✓	2-1/4" I.D.	4	4

SURFACE PROTECTION

General duty SurfaceGard® pads are sleek and shaped to cushion and protect. The subtle profile allows for uses throughout the home while offering sound-dampening benefits as well. For use on counters, table tops, and desks, or when applied to the undersides of lamps, vases, trinkets, and small appliances.



Felt Pads & Blankets

Cork Pads

Foam Pads

Bumpers

Clear Pads

Value Packs



SURFACE PROTECTION

In addition to our extensive line of felt options, Shepherd Hardware Products offers durable, self-adhesive surface protection pads made from other materials, such as cork, foam, and rubber.

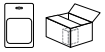

	SKU	MARKETS AVAILABLE	DESCRIPTION	UPC (0 39003)	PAD SHAPE & COLOR	MATERIALS	INSTALL		SIZE	PCS PER CARD	CRTN PACK QTY
							SELF ADHESIVE	SCREWS			
FELT	9021	ALL	Round Pads - Beige	09021 3	○	Felt	✓		3/8"	75	12
	9421	ALL	Round Pads - Green	09421 1	●	Felt	✓		3/8"	28	12
	9423	ALL	Round Pads Assortment - Green 16 - 3/8" Round Pads 8 - 1/2" Round Pads 10 - 5/8" Round Pads 12 - 3/4" Round Pads	09423 5	●●●●	Felt	✓		Contents 3/8" 1/2" 5/8" 3/4"	46 16 8 10 12	12
	9425	USA ONLY	Round Pads Assortment - Brown 16 - 3/8" Round Pads 8 - 1/2" Round Pads 10 - 5/8" Round Pads 12 - 3/4" Round Pads	09425 9	●●●●	Felt	✓		Contents 3/8" 1/2" 5/8" 3/4"	46 16 8 10 12	12
	9427	USA ONLY	Blankets - Green	09427 3	■	Felt	✓		4-1/4" x 6"	2	12
	9433	USA ONLY	Large Blanket - Green	09433 4	■	Felt	✓		6" x 18"	1	12
	9820	ALL	Round Pads - Green	09820 2	●	Felt	✓		1/2"	24	12
	9821	USA ONLY	Round Pads - Green	09821 9	●	Felt	✓		3/4"	12	12
	9822	ALL	Round Pads - Brown	09822 6	●	Felt	✓		1"	4	12
	9823	USA ONLY	Square Pads - Brown	09823 3	■	Felt	✓		1"	4	12
	9949	ALL	Round Pads - Brown	09949 0	●	Felt	✓		3/8"	75	12
	9956	ALL	Blankets - Brown	09956 8	■	Felt	✓		4-1/4" x 6"	2	12
	9957	ALL	Round Pads - White	09957 5	○	Felt	✓		3/8"	75	12
	9958	ALL	Round Pads - Brown	09958 2	●	Felt	✓		1/2"	24	12
	9959	ALL	Round Pads - Brown	09959 9	●	Felt	✓		3/4"	12	12
9960	ALL	Square Pads - Brown	09960 5	■	Felt	✓		3/4"	12	12	
CORK	9961	ALL	Round Pads - Cork	09961 2	●	Cork	✓		3/4"	12	12
	9962	ALL	Round Pads - Cork	09962 9	●	Cork	✓		1/2"	24	6
FOAM	9973	ALL	Non-Skid Round Pads - Black	09973 5	●	Foam	✓		3/4"	12	6
	9974	ALL	Non-Skid Round Pads - Black	09974 2	●	Foam	✓		1/2"	24	6
	9980	ALL	Non-Skid Strips - Black	09980 3	—	Foam	✓		3/8" x 2-3/8"	6	12
BUMPERS	9072	ALL	Screw Bumpers - White	09072 5	□	Rubber	✓		7/8"	4	6
	9131	ALL	Screw Bumpers - Clear	09131 9	□	Rubber	✓		7/8"	4	6
	9560	USA ONLY	Square Pads - White	09560 7	■	Rubber	✓		1/2"	9	6
	9561	USA ONLY	Square Pads - Brown	09561 4	■	Rubber	✓		1/2"	9	6
	9563	USA ONLY	Square Pads - White	09563 8	■	Rubber	✓		3/4"	12	6
	9564	USA ONLY	Square Pads - Brown	09564 5	■	Rubber	✓		3/4"	12	6
	9562	ALL	Square Pads - Clear ⚠	09562 1	■	PVC	✓		1/2"	9	6
	9565	ALL	Square Pads - Clear ⚠	09565 2	■	PVC	✓		3/4"	12	6
	9963	ALL	Rectangle Pads - Clear ⚠	09963 6	□	PVC	✓		1/2" x 1"	8	12
CLEAR PADS	9964	ALL	Round Pads - Clear ⚠	09964 3	○	PVC	✓		3/8"	16	12
	9965	ALL	Round Pads - Clear ⚠	09965 0	○	PVC	✓		3/4"	8	12
	9966	ALL	Round Discs - Clear ⚠	09966 7	○	PVC	—	—	3/4"	10	12
	9967	ALL	Round Pads - Clear ⚠	09967 4	○	PVC	✓		1/2"	16	12
	9969HS	USA ONLY	Value Pack 16 - 3/8" Clear Pads 16 - 1/2" Clear Pads 4 - 3/4" Clear Pads ⚠	09969 8	○●○	PVC	✓		Contents 3/8" 1/2" 3/4"	36 16 16 4	12
	9969	CANADA ONLY	Value Pack 16 - 3/8" Clear Pads 16 - 1/2" Clear Pads 4 - 3/4" Clear Pads	09969 8	○●○	PVC	✓		Contents 3/8" 1/2" 3/4"	36 16 16 4	12
	MIXED VALUE PACKS	9943	USA ONLY	Value Pack 24 - 1/2" Cork Pads 12 - 3/4" Cork Pads 24 - 1/2" Foam Non-Skid Pads 12 - 3/4" Foam Non-Skid Pads 16 - 3/8" Clear Pads ⚠	09943 8	●●●○	Cork Cork Foam Foam PVC	✓		Contents 1/2" 3/4" 1/2" 3/4" 3/8"	88 24 12 24 16
9943D		CANADA ONLY	Value Pack 24 - 1/2" Cork Pads 12 - 3/4" Cork Pads 24 - 1/2" Foam Non-Skid Pads 12 - 3/4" Foam Non-Skid Pads 16 - 3/8" Clear Pads	09943 8	●●●○	Cork Cork Foam Foam PVC	✓		Contents 1/2" 3/4" 1/2" 3/4" 3/8"	88 24 12 24 16	12
BOXED KITS	9046	ALL	Surface Protection Kit 24 - 3/4" Round Felt Pads 6 - 1-1/2" Round Felt Pads 24 - 1" Round Felt Pads 44 - 3/8" Round Felt Pads 18 - 1/2" x 2-5/8" Felt Strip Pads 12 - 1" SlideGlide Pads for Carpet 24 - 1/2" Clear Round Pads ⚠ 8 - 5/8" Round Nail-on Tacks 8 - 7/8" Round Nail-on Glides 8 - 1" Anti-Skid Screw-on Pads ⚠	09046 6	●●●○●○●○	Felt Felt Felt Felt Felt SlideGlide Clear Bumpers Tacks Glides Anti-Skid	—	—	Contents 3/4" 1-1/2" 1" 3/8" 1/2" x 2-5/8" 1" 1/2" 5/8" 7/8" 1"	180 24 6 24 44 18 12 24 8 8 8	6

⚠ WARNING: Cancer — www.P65Warnings.ca.gov.

Leg tips protect floor surfaces and allow for non-slip or easy-sliding function. Multiple material options and installation methods fit most tubular furniture. Reinforced crutch tips increase life of these high-wear components.

LEG TIPS



Rubber	45
Rubber Bulk Packaging	45
Rubber Crutch Tips	45
Clear Plastic	46
Clear Plastic Bulk Packaging	46
Vinyl	46
Low Friction	46
Plastic Square	46
Plastic w/Felt Base	47
Plastic	47
Plastic Inside	47

RUBBER LEG TIPS

Round, non-skid off-white or black rubber tips fit over furniture legs and other tubular items.



SKU	MARKETS AVAILABLE	OUTER DIAMETER OF FURNITURE LEG	UPC (0 39003)	LEG TIP COLOR	LEG TIP HEIGHT	PIECES PER CARD	CARTON PACK QUANTITY
9117	ALL	1/2"	09117 3	☐	1"	4	6
9118	ALL	5/8"	09118 0	☐	1-1/8"	4	6
9119	ALL	3/4"	09119 7	☐	1-1/4"	4	6
9120	ALL	7/8"	09120 3	☐	1-5/16"	4	6
9121	ALL	1"	09121 0	☐	1-1/2"	4	6
9122	ALL	1-1/8"	09122 7	☐	1-5/8"	4	6
9223	ALL	1-1/4"	09223 1	☐	2"	2	6
9225	USA ONLY	1-1/2"	09225 5	☐	2"	2	6
9124	ALL	1/2"	09124 1	■	1"	4	6
9125	ALL	5/8"	09125 8	■	1-1/8"	4	6
9126	ALL	3/4"	09126 5	■	1-1/4"	4	6
9127	ALL	7/8"	09127 2	■	1-5/16"	4	6
9128	ALL	1"	09128 9	■	1-1/2"	4	6
9129	ALL	1-1/8"	09129 6	■	1-5/8"	4	6
9224	ALL	1-1/4"	09224 8	■	2"	2	6
9226	USA ONLY	1-1/2"	09226 2	■	2"	2	6

BULK RUBBER LEG TIPS

Individually bagged tips in multiple carton quantities.



SKU	MARKETS AVAILABLE	OUTER DIAMETER OF FURNITURE LEG	UPC (0 39003)	LEG TIP COLOR	LEG TIP HEIGHT	PIECE PER BAG	CARTON PACK QUANTITY
3201	USA ONLY	1/2"	03201 5	■	1"	1	40
3202	USA ONLY	5/8"	03202 2	■	1-1/8"	1	40
3203	USA ONLY	3/4"	03203 9	■	1-1/4"	1	40
3204	USA ONLY	7/8"	03204 6	■	1-5/16"	1	40
3205	USA ONLY	1"	03205 3	■	1-1/2"	1	40
3206	USA ONLY	1-1/8"	03206 0	■	1-5/8"	1	40
3207	USA ONLY	1-1/4"	03207 7	■	2"	1	40
3208	USA ONLY	1-1/2"	03208 4	■	2"	1	40
3210	USA ONLY	1/2"	03210 7	☐	1"	1	40
3211	USA ONLY	5/8"	03211 4	☐	1-1/8"	1	40
3212	USA ONLY	3/4"	03212 7	☐	1-1/4"	1	40
3213	USA ONLY	7/8"	03213 8	☐	1-5/16"	1	40
3214	USA ONLY	1"	03214 5	☐	1-1/2"	1	40
3215	USA ONLY	1-1/8"	03215 2	☐	1-5/8"	1	40
3216	USA ONLY	1-1/4"	03216 9	☐	2"	1	40
3217	USA ONLY	1-1/2"	03217 6	☐	2"	1	40
9751	ALL	1/2"	09751 9	☐	1"	1	24
9752	ALL	5/8"	09752 6	☐	1-1/8"	1	24
9753	ALL	3/4"	09753 3	☐	1-1/4"	1	24
9754	ALL	7/8"	09754 0	☐	1-5/16"	1	24
9755	USA ONLY	1"	09755 7	☐	1-1/2"	1	24
9756	ALL	1-1/8"	09756 4	☐	1-5/8"	1	24
9743	USA ONLY	1-1/4"	09743 4	☐	2"	1	24
9758	ALL	1/2"	09758 8	■	1"	1	24
9759	ALL	5/8"	09759 5	■	1-1/8"	1	24
9760	USA ONLY	3/4"	09760 1	■	1-1/4"	1	24
9761	USA ONLY	7/8"	09761 8	■	1-5/16"	1	24
9762	ALL	1"	09762 5	■	1-1/2"	1	24
9763	USA ONLY	1-1/8"	09763 2	■	1-5/8"	1	24
9746	USA ONLY	1-1/4"	09746 5	■	2"	1	24
9766	USA ONLY	1-1/2"	09766 3	■	2"	1	12

RUBBER CRUTCH TIPS

Steel reinforced rubber tips provide more contact with the ground and improved performance of crutches, canes and walkers.



SKU	MARKETS AVAILABLE	OUTER DIAMETER OF CANE/CRUTCH LEG	UPC (0 39003)	LEG TIP COLOR	CRUTCH TIP HEIGHT	PIECES PER CARD	CARTON PACK QUANTITY
9742	USA ONLY	3/4" - 7/8"	09742 7	☐	2-1/2"	2	6

CLEAR THERMOPLASTIC ETHYLENE LEG TIPS

Round, non-skid clear TPE tips fit over furniture legs and other tubular items for inconspicuous use on carpet or hard surface floors.



SKU	MARKETS AVAILABLE	OUTER DIAMETER OF FURNITURE LEG	UPC (0 39003)	LEG TIP COLOR	LEG TIP HEIGHT	PIECES PER CARD	CARTON PACK QUANTITY
6210	ALL	3/4"	06210 4		3/4"	4	6
6211	ALL	7/8"	06211 1		3/4"	4	6
6212	ALL	1"	06212 8		3/4"	4	6
6213	ALL	1-1/8"	06213 5		1-1/8"	4	6
6214	ALL	1-1/2"	06214 2		1-1/8"	4	6
BULK CLEAR LEG TIPS							
6610	ALL	3/4"	06610 2		3/4"	—	24
6611	ALL	7/8"	06611 9		3/4"	—	24
6612	ALL	1"	06612 6		3/4"	—	24

VINYL LEG TIPS

Round, easy sliding black or white vinyl tips fit over furniture legs and other tubular items for use on carpet or hard surface floors.



SKU	MARKETS AVAILABLE	OUTER DIAMETER OF FURNITURE LEG	UPC (0 39003)	LEG TIP COLOR	LEG TIP HEIGHT	PIECES PER CARD	CARTON PACK QUANTITY
9205	USA ONLY	1/2"	09205 7		1-3/16"	4	6
9200	USA ONLY	5/8"	09200 2		1-1/4"	4	6
9201	USA ONLY	3/4"	09201 9		1-1/4"	4	6
9202	USA ONLY	7/8"	09202 6		1-5/16"	4	6
9203	ALL	1"	09203 3		1-1/2"	4	6
9204	USA ONLY	1-1/8"	09204 0		1-1/2"	4	6
9210	CANADA ONLY	5/8"	09210 1		1-1/4"	4	6
9211	CANADA ONLY	3/4"	09211 8		1-1/4"	4	6
9212	ALL	7/8"	09212 5		1-5/16"	4	6
9213	ALL	1"	09213 2		1-1/2"	4	6

WARNING: Cancer — www.P65Warnings.ca.gov.

LOW FRICTION CHAIR TIPS

Round, easy sliding black plastic tips fit over furniture legs and other tubular items for use on carpet and non-abrasive floors.



SKU	MARKETS AVAILABLE	OUTER DIAMETER OF FURNITURE LEG	UPC (0 39003)	LEG TIP COLOR	LEG TIP HEIGHT	PIECES PER CARD	CARTON PACK QUANTITY
9219	USA ONLY	1"	09219 4		1"	4	6
9220	USA ONLY	1-1/8" -1-1/4"	09220 0		1-1/8"	4	6

PLASTIC SQUARE TIPS

Square, easy-sliding black plastic tips fit over furniture legs and other tubular items for use on carpet or hard surface floors.



SKU	MARKETS AVAILABLE	OUTER DIAMETER OF FURNITURE LEG	UPC (0 39003)	LEG TIP COLOR	LEG TIP HEIGHT	PIECES PER CARD	CARTON PACK QUANTITY
9234	ALL	1"	09234 7		11/16"	4	6

PLASTIC LEG TIPS WITH FELT

Round, white or black plastic tips fit over furniture legs with integrated heavy duty felt surface for easy sliding over hard surface floors.



SKU	MARKETS AVAILABLE	OUTER DIAMETER OF FURNITURE LEG	UPC (0 39003)	LEG TIP COLOR	LEG TIP HEIGHT	PIECES PER CARD	CARTON PACK QUANTITY
3921	ALL	3/4"	03921 2	□	7/8"	4	6
3922	ALL	7/8"	03922 9	□	7/8"	4	6
3923	ALL	1"	03923 6	□	7/8"	4	6
3924	ALL	1-1/4"	03924 3	□	1"	4	6
3931	ALL	3/4"	03931 1	■	7/8"	4	6
3932	ALL	7/8"	03932 8	■	7/8"	4	6
3933	ALL	1"	03933 5	■	7/8"	4	6
3934	ALL	1-1/4"	03934 2	■	1"	4	6

PLASTIC LEG TIPS

Round, easy sliding black or white tips fit over furniture legs and other tubular items for use on carpet or hard surface floors.



SKU	MARKETS AVAILABLE	OUTER DIAMETER OF FURNITURE LEG	UPC (0 39003)	LEG TIP COLOR	LEG TIP HEIGHT	PIECES PER CARD	CARTON PACK QUANTITY
9105	USA ONLY	1/2"	09105 0	□	5/8"	4	6
9106	ALL	5/8"	09106 7	□	5/8"	4	6
9107	ALL	3/4"	09107 4	□	3/4"	4	6
9108	ALL	7/8"	09108 1	□	5/8"	4	6
9109	ALL	1"	09109 8	□	5/8"	4	6
9744	ALL	1-1/8"	09744 1	□	7/8"	4	6
9745	ALL	1-1/4"	09745 8	□	7/8"	4	6
9111	ALL	1/2"	09111 1	■	5/8"	4	6
9112	ALL	5/8"	09112 8	■	5/8"	4	6
9113	ALL	3/4"	09113 5	■	3/4"	4	6
9114	ALL	7/8"	09114 2	■	5/8"	4	6
9115	ALL	1"	09115 9	■	5/8"	4	6
9768	ALL	1-1/8"	09768 7	■	7/8"	4	6
9769	ALL	1-1/4"	09769 4	■	7/8"	4	6

TIP:
Placing single material Plastic, Rubber or Vinyl leg tips in warm water for several minutes improves suppleness and eases installation.

PLASTIC INSIDE TIPS

Round, square, and angled, easy-sliding black plastic tips fit into recessed cavities of furniture legs and other tubular items for use on carpet or hard surface floors.



SKU	MARKETS AVAILABLE	OUTER DIAMETER OF FURNITURE LEG	UPC (0 39003)	LEG TIP BASE SHAPE & COLOR	LEG TIP HEIGHT	PIECES PER CARD	CARTON PACK QUANTITY
9206	CANADA ONLY	3/4"	09206 4	●	—	4	6
9207	CANADA ONLY	7/8"	09207 1	●	—	4	6
9208	CANADA ONLY	1"	09208 8	●	—	4	6
9209	CANADA ONLY	1-1/4"	09209 5	●	—	4	6
9235	ALL	3/4"	09235 4	■	—	4	6
9236	ALL	7/8"	09236 1	■	—	4	6
9237	ALL	1"	09237 8	■	—	4	6
9238	CANADA ONLY	3/4"	09238 5	▲	—	4	6
9239	CANADA ONLY	7/8"	09239 2	▲	—	4	6

Glides are designed for use on infrequently moved furniture. Swivel glides are adaptive to work on angled furniture legs. Threaded stem options promote easy leveling. WonderLevel system eliminates table wobble on carpet and hard surface floors.

GLIDES



Carpet Base Nail-On
Cushioned Nail-On
Swivel Nail-On
Plastic Base Nail-On
Swivel - Nylon Base
Threaded Stems
WonderLevel



GLIDES

Carpet Base glides are nailed into wood and not for angled or chair legs. **Cushioned** glides are nailed into wooden legs and have a forgiving & sound-dampening middle layer with either polished nickel or white plastic base and not for angled legs. Brass-plated **Swivel** glides are nailed into angled wooden legs and have a white plastic base. White **Rigid Plastic** glides are nailed into wood and not for angled or chair legs. Brass-plated **Tap-on Swivel** glides fit over tubular metal legs and have a white nylon base. Black **Rigid Phenolic** glides have a 5/16" threaded stem for easy leveling of infrequently moved items. **Threaded Cushioned** glides have a forgiving & sound-dampening middle layer with polished nickel base and threaded stem for easy leveling with or without included plastic sockets.

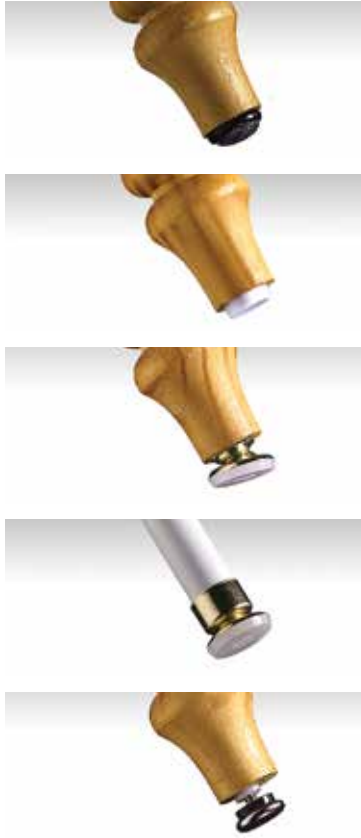

	SKU	MARKETS AVAILABLE	BASE TYPE	UPC (0 39003)	BASE SHAPE	SIZE	PIECES PER CARD	CARTON PACK QUANTITY
NAIL-ON STEMS for Wood Furniture Only	9103	ALL	Carpet	09103 6	●	1"	4	6
	9155	ALL	Carpet	09155 5	●	1-1/4"	4	6
	9099	ALL	Nickel Cushioned	09099 2	●	7/8"	4	6
	9100	ALL	Nickel Cushioned	09100 5	●	1-1/16"	4	6
	9101	USA ONLY	Nickel Cushioned	09101 2	●	1-1/4"	4	6
	9445	ALL	Plastic Cushioned	09445 7	●	5/8"	4	6
	9446	ALL	Plastic Cushioned	09446 4	●	3/4"	4	6
	9447	ALL	Plastic Cushioned	09447 1	●	7/8"	4	6
	9448	ALL	Plastic Cushioned	09448 8	●	1-1/8"	4	6
	9513	ALL	Plastic Cushioned	09513 3	●	1-1/2"	4	6
	9098	ALL	Plastic Swivel	09098 5	●	1"	4	6
	9102	ALL	Rigid Plastic	09102 9	●	7/8"	4	6
	9143	ALL	Rigid Plastic	09143 2	●	5/8"	4	6
9144	ALL	Rigid Plastic	09144 9	●	3/4"	4	6	
TAP-ON for Tubular Furniture	9094	CANADA ONLY	Nylon Swivel	09094 7	●	5/8" I.D.	4	6
	9095	CANADA ONLY	Nylon Swivel	09095 4	●	3/4" I.D.	4	6
	9096	CANADA ONLY	Nylon Swivel	09096 1	●	7/8" I.D.	4	6
	9097	CANADA ONLY	Nylon Swivel	09097 8	●	1" I.D.	4	6
THREADED STEMS	9444	ALL	Rigid Phenolic Metal	09444 0	●	1-1/4"	4	6
	9449	ALL	Nickel Cushioned	09449 5	●	7/8"	4	6
	9450	ALL	Nickel Cushioned	09450 1	●	1-1/16"	4	6
	9451	ALL	Nickel Cushioned	09451 8	●	1-1/4"	4	6

TIP:
Nail-on glides are made for straight legs only. Swivel glides are made for angled legs.

TIP:
Always pre-drill 1/16" starter hole before hammering nail-on glides to avoid splitting wood.

TIP:
Cushioned & rigid plastic glides are made for use on carpeting. Carpet base glides can be used on non-wooden hard floors.

WonderLevel®
Eliminates Table Wobble!



Spring-loaded **Self-Leveling** table feet that automatically adjust to uneven floors and combat table wobble. One set contains both **FeltGard®** pads and **SlideGlide®** pads for performance on either hard surface floors or carpet.



SKU	MARKETS AVAILABLE	CONTENTS DESCRIPTION	UPC (0 39003)	LOAD CAPACITY EACH	PIECES PER CARD	CARTON PACK QUANTITY
9485	ALL	Self-Leveling Table Kit - Fixes 1 Table 4 - 1" Levelers w/ 1/4" 20 Threaded Stem 4 - 1" Slide Glide® Pads for Carpet 4 - 1" FeltGard® Pads for Wood Floors 4 - 1/2" Plastic Sockets for Wood Legs 1 - Hex Wrench for Secure Installation	09485 3	35 lbs	1 Set of 4	6

DOOR MANAGEMENT

Door and wall-related products to control swinging doors and protect your home. Plastic shims are commonly used in the installation of doors and frames.

Door Stops

- Cushioned
- Spring
- Rubber Wedges

Wall & Knob Protection

WEDGE IT® Plastic Shims



DOOR STOPS

Self-adhesive **cushioned** door stops are applied to the wall opposite door knobs to protect the wall. Classic **spring**-type door stops are installed into and protect baseboards. Non-permanent **wedges** are positioned under door to limit or fix position. **Jumbo** size is fitted for larger and heavier doors with up to 2" clearance.

TIP:
Install off-center to avoid accidentally locking the door when doorknob comes in contact with cushion on wall.

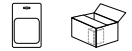

SKU	MARKETS AVAILABLE	DESCRIPTION	UPC (0 39003)	COLOR/ FINISH & SHAPE	INSTALLATION METHOD	PIECES PER CARD	CARTON PACK QUANTITY
9568	ALL	Cushion	0968 3	○	Self-Adhesive	2	6
9573	USA ONLY	Cushion	09573 7	○	Self-Adhesive	1	6
9498	CANADA ONLY	Spring	09498 3	Nickel	Screw	2	6
9500	CANADA ONLY	Spring	09500 3	Brass	Screw	2	6
9132	ALL	Rubber Wedge	09132 6	▲	—	2	6
9162	ALL	Rubber Wedge	09162 3	▲	—	2	6
9133	ALL	Rubber Wedge w/Lip	09133 3	▲	—	1	6
9163	ALL	Rubber Wedge w/Lip	09163 0	▲	—	1	6
9333	ALL	Woodgrain Wedge	09333 7	▲	—	1	6
3762	CANADA ONLY	Jumbo Wedge	03762 1	▲	—	1	4
3763	ALL	Jumbo Wedge	03763 8	▲	—	1	4



Economical solution to prevent additional damage and quickly cover existing blemishes without messy or costly repairs.



WALL & DOOR KNOB PROTECTORS

Self-adhesive and paintable circular **discs** available in two diameters.



SKU	MARKETS AVAILABLE	UPC (0 39003)	COLOR/ SHAPE	SIZE	PIECES PER CARD	CARTON PACK QUANTITY
9551	ALL	09551 5	○	3-1/4"	1	6
9552	ALL	09552 2	○	5"	1	6



PLASTIC SHIMS

Impervious to water and insect damage, **plastic shims** are tapered from 1/16" to 3/16" to level and support cabinets, doors, and construction projects. Bulk-packaged, resealable jar contains 300 pieces.



SKU	MARKETS AVAILABLE	DESCRIPTION	UPC (0 39003)	COLOR/ SHAPE	SIZE	PIECES PER CARD	CARTON PACK QUANTITY
9435	ALL	Wedge It® Carded Shims	09435 8	▭	2" x 1-1/8"	6	6
9436	USA ONLY	Wedge It® Bulk Jar of Shims	09436 5	▭	2" x 1-1/8"	300	1

Common replacement parts found on patio furniture. Refresh outdoor living spaces with minimal effort.

PATIO



Patio Tips

Cup Inserts

Domed Inserts

Round Inserts

Square Inserts

Umbrella Ring Set

PATIO FURNITURE

Tips fit over round tubular legs for smooth gliding and floor protection. **Inserts** fit into recessed cavities of tubular legs for smooth gliding and floor protection. **Domed** shape can be used for straight or angled legs. Vinyl **square** inserts fit into the most common square tubular furniture. Transparent **umbrella hole ring** snaps into the center of tables to stabilize, align and protect patio umbrella. Transparent **cap** fills the hole for a finished look when umbrella is not in use. **Insert cups** fit into the feet of wrought iron furniture for smooth gliding and floor protection.



SKU	MARKETS AVAILABLE	DESCRIPTION	UPC (0 39003)	SHAPE & COLOR	INNER DIAMETER	OUTER DIAMETER	PIECES PER CARD	CARTON PACK QUANTITY
3005	CANADA ONLY	Plastic Tip	03005 9		1-1/4"	—	4	6
3010	USA ONLY	Plastic Insert	03010 3		3/4"	7/8"	4	6
3011	USA ONLY	Plastic Insert	03011 0		7/8"	1"	4	6
3015	USA ONLY	Plastic Domed Insert	03015 8		1"	—	4	6
⚠ 3025	USA ONLY	Vinyl Square Insert	03025 7		5/8"	—	4	6
3030	USA ONLY	Plastic Umbrella Hole Ring & Cap	03030 1		2"	—	1	6
3039S	USA ONLY	Plastic Insert Cups	03039 4		1-1/4"	—	4	6
3040	ALL	Plastic Insert Cups	03040 0		1-1/2"	—	4	6

⚠ **WARNING: Cancer** — www.P65Warnings.ca.gov.

TIP:
Spread a thin layer of liquid dish soap on the ends of metal chair legs before installing tips.



Not everything fits into a category! Miscellaneous products include a sturdy line of lazy susans and a snowmobile dolly set.

MISCELLANEOUS



Lazy Susans

Snowmobile Dolly

LAZY SUSANS

Steel bases rotate on ball bearings for smooth and reliable turntables, displays, and storage solutions.



SKU	MARKETS AVAILABLE	DIAMETER	UPC (0 39003)	LAZY SUSAN SHAPE	MATERIAL	LOAD CAPACITY	PIECES PER POLYBAG	CARTON PACK QUANTITY
9546	ALL	3"	09546 1	■	Steel	200	1	10
9547	ALL	4"	09547 8	■	Steel	400	1	10
9548	ALL	6"	09548 5	■	Steel	500	1	5
9549	ALL	12"	09549 2	●	Steel	1000	1	5

SNOWMOBILE DOLLY SET

3 piece set supports snowmobile skis and track for safe maneuvering on hard surfaces.

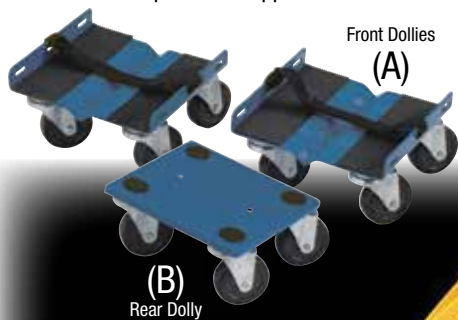

Front Dollies

(A)

(B)
Rear Dolly



SKU	MARKETS AVAILABLE	UPC (0 39003)	WHEEL DIAMETER	WHEEL MATERIAL	DIMENSIONS (A) FRONT DOLLY	DIMENSIONS (B) REAR DOLLY	LOAD CAPACITY	PIECES PER SET	CARTON PACK QUANTITY
9298	ALL	09298 9	2-1/2"	Hard Rubber	7-1/8" x 7-3/4"	7-1/8" x 7-1/8"	990	3	2

- Heavy duty steel with rust-resistant powder-coated finish
- Includes (A) two 7-1/8" x 7-3/4" front dollies (grooved for snowmobile skis) and (B) one 7-1/8" x 7-1/8" rear dolly

SKU #	Category	Color Code	Page
3005	Patio Furniture_ Plastic White - Round 1-1/4"	Yellow	53
3010	Patio Furniture_ Internal Plastic White Round 3/4" – 7/8"	Yellow	53
3011	Patio Furniture_ Internal Plastic White Round 7/8" – 1"	Yellow	53
3015	Patio Furniture_ Internal Plastic White Round Dome 1"	Yellow	53
3025	Patio Furniture_ Internal Clear Round Bottom 5/8"	Yellow	53
3030	Patio Furniture_ Umbrella Hole Ring Set Clear	Yellow	53
3039S	Patio Furniture_ Plastic White Cup - Round / 1-1/4"	Yellow	53
3040	Patio Furniture_ Plastic White Cup - Round 1-1/2"	Yellow	53
3056	Caster_Cast Iron_4" Swivel	Blue	7
3057	Caster_Cast Iron_4" Rigid	Blue	7
3058	Caster_Cast Iron_5" Swivel	Blue	7
3059	Caster_Cast Iron_5" Rigid	Blue	7
3060	Caster_Cast Iron_6" Swivel	Blue	7
3061	Caster_Cast Iron_6" Rigid	Blue	7
3069	Caster_Pneumatic_12" Swivel	Blue	11
3063	Caster_Cast Iron_8" Rigid	Blue	7
3070	Caster_Pneumatic_12" Rigid	Blue	11
3115	Caster_Soft Rubber_4" Swivel	Blue	5
3116	Caster_Soft Rubber_4" Swivel w/Brake	Blue	5
3117	Caster_Soft Rubber_4" Rigid	Blue	5
3118	Caster_Polypropylene_4" Swivel	Blue	7
3119	Caster_Polypropylene_4" Rigid	Blue	7
3123	Caster_Polypropylene_6" Rigid	Blue	7
3124	Caster_Polypropylene_6" Swivel	Blue	7
3126	Caster_Polypropylene_8" Rigid	Blue	7
3127	Caster_Polypropylene_8" Swivel	Blue	7
3131	Caster_Mold-on Rubber_8" Swivel	Blue	10
3133	Caster_Mold-on Rubber_8" Rigid	Blue	10
3159	Caster_Mold-on Rubber_5" Swivel	Blue	10
3163	Caster_Mold-on Rubber_5" Rigid	Blue	10
3164	Caster_Mold-on Polyurethane/Steel Hub 4" Swivel	Blue	9
3166	Caster_Mold-on Polyurethane/Steel Hub 6" Swivel	Blue	9
3167	Caster_Mold-on Polyurethane/Steel Hub 8" Swivel	Blue	9
3172	Caster_Mold-on Polyurethane/Steel Hub 4" Rigid	Blue	9
3174	Caster_Mold-on Polyurethane/Steel Hub 6" Rigid	Blue	9
3175	Caster_Mold-on Polyurethane/Steel Hub 8" Rigid	Blue	9
3176	Caster_Mold-on TPR/Black Polyprop Hub 4" Rigid	Blue	8
3177	Caster_Mold-on TPR/Black Polyprop Hub 4" Swivel	Blue	8
3178	Caster_Mold-on TPR/Black Polyprop Hub 4" Swvl w/Brake	Blue	8
3179	Caster_Mold-on TPR_5" Rigid	Blue	8
3180	Caster_Mold-on TPR_5" Swivel	Blue	8
3182	Caster_Mold-on TPR_6" Rigid	Blue	8
3183	Caster_Mold-on TPR_6" Swivel	Blue	8
3184	Caster_Mold-on TPR/ Polypropylene Hub_ 6" Swvl w/Brake	Blue	8
3186	Caster_Mold-on TPR_8" Swivel	Blue	8
3201	Leg Tip_Rubber_1/2" Black	Yellow	45
3202	Leg Tip_Rubber_5/8" Black	Yellow	45

SKU #	Category	Color Code	Page
3203	Leg Tip_Rubber_3/4" Black	Yellow	45
3204	Leg Tip_Rubber_7/8" Black	Yellow	45
3205	Leg Tip_Rubber_1" Black	Yellow	45
3206	Leg Tip_Rubber_1-1/8" Black	Yellow	45
3207	Leg Tip_Rubber_1-1/4" Black	Yellow	45
3208	Leg Tip_Rubber_1-1/2" Black	Yellow	45
3210	Leg Tip_Rubber_1/2" Off-White	Yellow	45
3211	Leg Tip_Rubber_5/8" Off-White	Yellow	45
3212	Leg Tip_Rubber_3/4" Off-White	Yellow	45
3213	Leg Tip_Rubber_7/8" Off-White	Yellow	45
3214	Leg Tip_Rubber_1" Off-White	Yellow	45
3215	Leg Tip_Rubber_1-1/8" Off-White	Yellow	45
3216	Leg Tip_Rubber_1-1/4" Off-White	Yellow	45
3217	Leg Tip_Rubber_1-1/2" Off-White	Yellow	45
3258	Caster_Mold-on TPR_2-1/2" Swvl w/Brake	Blue	8
3259	Caster_Mold-on TPR_2-1/2" Swvl w/Brake	Blue	8
3264	Caster_Mold-on TPR_2" Swvl w/Brake	Blue	8
3265	Caster_Mold-on TPR_3" Swivel	Blue	8
3266	Caster_Mold-on TPR_3" Swvl w/Brake	Blue	8
3275	Caster_Polyurethane_8" Rigid	Blue	9
3276	Caster_Mold-on Polyurethane_8" Swivel	Blue	9
3277	Caster_Mold-on Polyurethane_4" Swivel	Blue	9
3278	Caster_Mold-on Polyurethane_4" Rigid	Blue	9
3279	Caster_Mold-on Polyurethane_5" Swivel	Blue	9
3280	Caster_Mold-on Polyurethane_5" Rigid	Blue	9
3320	Caster_Mold-on Polyurethane_3" Swivel Medium Duty Red	Blue	9
3321	Caster_Mold-on Polyurethane_3" Swivel Oeil Med. Duty Red	Blue	9
3322	Caster_Mold-on Polyurethane_3" Swivel Medium Duty Red	Blue	9
3332	Wheel_Inner Tube_ Fits 6" w/L Valve Stem	Brown	25
3335	Wheel_10" Tire fits 4" Rim - Sawtooth Tread	Brown	25
3336	Wheel_16" Tubeless Tire - Ribbed Tread	Brown	25
3337	Wheel_14" Tubeless Tire - Ribbed Tread	Brown	25
3339	Wheel_7" Semi-Pneumatic Rubber Metal Hub	Brown	24
3354	Move-it_PREMIER Series	Black	27
3355	Wheel_8" Semi-Pneumatic Rubber Metal Hub	Brown	24
3360	Move-it_HOME Series	Black	27
3361	Move-it_PREMIER Series	Black	27
3362	Move-it_PREMIER Series	Black	27
3363	Move-it_PREMIER Series	Black	27
3365	Move-it_PREMIER Series	Black	27
3366	Move-it_HOME Series	Black	27
3367	Move-it_HOME Series	Black	27
3368	Move-it_HOME Series	Black	27
3541	Caster_Medium Duty TPU	Blue	9
3542	Caster_Medium Duty TPU	Blue	9
3543	Caster_Medium Duty TPU	Blue	9
3545	Caster_Medium Duty TPR	Blue	8

SKU #	Category	Color Code	Page
3546	Caster_Medium Duty TPR	■	8
3547	Caster_ Medium Duty TPR	■	8
3598	SurfaceGrip_Anti-Skid_2" x 4" Blanket	■	41
3600	SurfaceGrip_Anti-Skid_4-1/4" x 6" Blanket	■	41
3601	SurfaceGrip_Anti-Skid_3/4" Round Pad	■	41
3602	SurfaceGrip_Anti-Skid_1" Round Pad	■	41
3603	SurfaceGrip_Anti-Skid_1-1/2" Round Pad	■	41
3608	SurfaceGrip_Anti-Skid_2-1/2" Round Pad	■	41
3615	SurfaceGrip_Anti-Skid_1" Square Pad	■	41
3616	SurfaceGrip_Anti-Skid_1-1/2" x 1-1/2" Corner Pad	■	41
3624	SurfaceGrip_Anti-Skid_1" x 3-3/4" Pad	■	41
3627	SurfaceGrip_Anti-Skid_2" Round Pad	■	41
3628	SurfaceGrip_Anti-Skid_3" Round Pad	■	41
3633	FeltGard+_Snap-on/off Pads_7/8" Round Pads	■	33
3634	FeltGard+_Snap-on/off Pads_1" Round Pads	■	33
3635	FeltGard+_Snap-on/off Pads_1-1/2" Round Pads	■	33
3636	FeltGard+_Snap-on/off Pads_7/8" Round Pads - Felt only	■	33
3637	FeltGard+_Snap-on/off Pads_1" Round Pads - Felt only	■	33
3638	FeltGard+_Snap-on/off Pads_1-1/2" Round Pads - Felt only	■	33
3687	Slider 'n Gripper_3 -1/4" Wood Effect Dual Function Pad	■	41
3691	Slider 'n Gripper_1" Wood Effect Furniture Glide	■	41
3692	Slider 'n Gripper_1-1/4" Non Slip Wood Effect Furniture Pad	■	41
3693	Slider 'n Gripper_2" Wood Effect Non Slip Furniture Cup	■	41
3694	Slider 'n Gripper_3/4" Wood Effect Furniture Glide	■	41
3696	Slider 'n Gripper_2-1/4" I.D. Wood Effect Non Slip Furn. Cup	■	41
3697	Slider 'n Gripper_1-3/4" I.D. Wood Effect Non Slip Furn. Cup	■	41
3728	Caster_Mold-on Polyurethane_3" Swivel	■	9
3729	Caster_Mold-on Polyurethane_3" Swivel w/Brake	■	9
3731	Caster_Mold-on TPR_3" Swivel	■	8
3732	Caster_Mold-on TPR_3" Rigid	■	8
3733	Caster_Mold-on TPR_3" Swivel w/Brake	■	8
3735	Caster_Mold-on TPR_4" Rigid	■	8
3736	Caster_Mold-on TPR_4" Swivel w/Brake	■	8
3737	Caster_Mold-on Polyurethane_3" Swivel	■	9
3738	Caster_Mold-on Polyurethane_3" Rigid	■	9
3739	Caster_Mold-on Polyurethane_3" Swivel w/Brake	■	9
3747	Caster_Mold-on TPU_4" Swivel	■	9
3748	Caster_Mold-on TPU_4" Swivel w/Brake	■	9
3749	Caster_Mold-on TPU_4" Rigid	■	9
3755	Caster_Mold-on TPU_3" Swivel	■	9
3756	Caster_Mold-on TPU_3" Rigid	■	9
3757	Caster_Mold-on TPU_3" Swivel w/Brake	■	9
3758	Caster_Mold-on TPU_4" Swivel	■	9
3759	Caster_Mold-on TPU_4" Rigid	■	9
3760	Caster_Mold-on TPU_4" Swivel w/Brake	■	9
3762	Door Stop_ Jumbo Heavy-Duty Door Wedge Black	■	51
3763	Door Stop_ Jumbo Heavy-Duty Door Wedge Yellow	■	51

SKU #	Category	Color Code	Page
3910	Caster_Twin Wheel _2" Swivel Plate	■	20
3911	Caster_Twin Wheel _2" Swivel Stem 02	■	20
3912	Caster_Twin Wheel _2" Swivel Stem 88	■	20
3921	FeltGard+_Leg Tip_3/4" Plastic Leg Tips w/ Felt White	■	47
3922	FeltGard+_Leg Tip_7/8" Plastic Leg Tips w/ Felt White	■	47
3923	FeltGard+_Leg Tip_1" Plastic Leg Tips w/ Felt White	■	47
3924	FeltGard+_Leg Tip_1-1/4" Plastic Leg Tips w/ Felt White	■	47
3931	FeltGard+_Leg Tip_3/4" Plastic Leg Tips w/ Felt Black	■	47
3932	FeltGard+_Leg Tip_7/8" Plastic Leg Tips w/ Felt Black	■	47
3933	FeltGard+_Leg Tip_1" Plastic Leg Tips w/ Felt Black	■	47
3934	FeltGard+_Leg Tip_1-1/4" Plastic Leg Tips w/ Felt Black	■	47
3943	Slide Glide Plus Pads_1-1/2" Round Self-Adhesive	■	37
3944	Slide Glide Plus Pads_2" Round Self-Adhesive	■	37
3948	Slide Glide Plus Pads_1" Square Self-Adhesive	■	37
3949	Slide Glide Plus Pads_2" Square Self-Adhesive	■	37
3951	Slide Glide Plus Pads_Value Pack 1" & 1-3/4" Round	■	37
3955	Slide Glide Plus Pads_3-1/2" Round Non-Adhesive	■	35
3956	Slide Glide Plus Pads_5" Square Non-Adhesive Store/Reuse	■	35
3957	Slide Glide Plus Pads_Value Pack_7" +3-1/2"	■	35
3960	Value Pack_3-1/2" Felt & Low Friction Sliders -Reuse/Store	■	35
4560	Designer Caster Display Rack w/Color Header Sign	■	15
6210	Leg Tip_Plastic_3/4" Clear	■	46
6211	Leg Tip_Plastic_7/8" Clear	■	46
6212	Leg Tip_Plastic_1" Clear	■	46
6213	Leg Tip_Plastic_1-1/8" Clear	■	46
6214	Leg Tip_Plastic_1-1/2" Clear	■	46
6610	Leg Tip_Plastic_3/4" Clear	■	46
6611	Leg Tip_Plastic_7/8" Clear	■	46
6612	Leg Tip_Plastic_1" Clear	■	46
6265	Designer Casters /COLOR/ 3" Snow	■	13
6266	Designer Casters /COLOR/ 3" Rhubarb	■	13
6267	Designer Casters /COLOR/ 3" Sky	■	13
6268	Designer Casters /Smooth/ 3" Chrome Spoke	■	13
6269	Designer Casters /Smooth/ 4" Chrome Spoke	■	13
6270	Designer Casters /Smooth/ 5" Chrome Spoke	■	13
6271	Designer Casters /COLOR/ 2" Cherry	■	13
6272	Designer Casters /COLOR/ 2" Ocean	■	13
6273	Designer Casters /COLOR/ 2" Honey	■	13
6274	Designer Casters /COLOR/ 2" Kermit	■	13
6275	Designer Casters /MAGS/ 3" Black Bling	■	13
6276	Designer Casters /MAGS/ 3" Black Bling w/Brake	■	13
6277	Designer Casters /CLEAR/ 1.4" Mini Jewel w/brake 2 pk	■	13
6278	Designer Casters /CLEAR/ 1.4" Mini Jewel 2 pk	■	13
6279	Designer Casters /CLEAR/ 2" Jewel w/Brake 2 pk	■	13
6280	Designer Casters /CLEAR/ 2" Jewel 2 pk	■	13
6281	Designer Casters /HUB-FREE/ 2-3/8" Wheel Vacant	■	14
6282	Designer Casters /HUB-FREE/ 2-3/8" Wheel Vacant w/Brake	■	14















































SKU #	Category	Color Code	Page
6283	Designer Casters /CLEAR/ 2" Twin Jewel	Light Green	13
6284	Designer Casters /WOODY/ 3" Trunk	Light Green	14
6285	Designer Casters /WOODY/ 3" Trunk w/Brake	Light Green	14
6286	Designer Casters /SAUCER/ 2" Aluminum Petite	Light Green	14
6287	Designer Casters /SAUCER/ 3" Aluminum Petite	Light Green	14
6288	Designer Casters /SAUCER/ 2" Aluminum Petite w/Brake	Light Green	14
6289	Designer Casters /SAUCER/ 3" Aluminum Petite w/Brake	Light Green	14
6290	Designer Casters /HUB-FREE/ 3" Twin Wheel Vacant	Light Green	14
6291	Designer Casters /HUB-FREE/ 3" Twin Wheel Vacant w/Brake	Light Green	14
6292	Designer Casters /Smooth/ 3" Skate	Light Green	13
6293	Designer Casters /Smooth/ 3" Race	Light Green	13
6294	Designer Casters /MAGS/ 3" Chrome Bling	Light Green	13
6295	Designer Casters /MAGS/ 3" Chrome Bling w/Brake	Light Green	13
6296	Designer Casters /MAGS/ 3" White Bling w/Brake	Light Green	13
6297	Designer Casters /MAGS/ 3" White Bling	Light Green	13
6298	Designer Casters /MAGS/ 3" Raw Bling	Light Green	13
6299	Designer Casters /MAGS/ 3" Raw Bling w/Brake	Light Green	13
6610	Leg Tip_Plastic_3/4" Clear 24 pcs	Orange	46
6611	Leg Tip_Plastic_7/8" Clear 24 pcs	Orange	46
6612	Leg Tip_Plastic_1" Clear 24 pcs	Orange	46
6705	Commercial Grade Felt 3/4" Round pads 20 pcs	Yellow	30
6706	Commercial Grade Felt 1" Round pads 16 pcs	Yellow	30
6707	Commercial Grade Felt 1-1/2" Round pads 8 pcs	Yellow	30
6708	Commercial Grade Felt 1" Rounds pads 48 pcs	Yellow	30
6709	Commercial Grade Felt 1" Round pads 96 Pcs	Yellow	30
6710	Commercial Grade Felt Roll 1/2" x 58"	Yellow	30
6720	Eclipse Felt Pads 1" Round 16 pcs	Dark Blue	33
6721	Eclipse Felt Pads 1" Round 48 pcs	Dark Blue	33
6730	Value Pack Polybag Heavy-duty Felt Pads 82 pcs - Beige	Dark Blue	31
6731	Value Pack Polybag Heavy-duty Felt Pads 82 pcs - Brown	Dark Blue	31
8569	Bed Sliders insert into Bed Frame for Easy Moving	Green	17
8734E	Caster_Gate Flat-Free_8" Swivel Spring Loaded	Dark Blue	11
8735E	Caster_Gate Hard Rubber_5" Swivel Spring Loaded	Dark Blue	11
8747	Caster Chair Kit_Universal Twin Wheel_ 2" Swivel Hard Tread	Dark Blue	21
8748	Caster Chair Kit_Universal Twin Wheel_ 2" Swivel Soft Tread	Dark Blue	21
89851	Move-it_PREMIER Series_70" x 80" Blanket Blue	Black	27
9008	Caster_Soft Rubber_2" Swivel Grip ring Stem 87	Dark Blue	5
9011	Caster_Toolbox_5" Swivel w/Brake	Dark Blue	11
9012	Caster_Toolbox_5" Swivel w/Brake	Dark Blue	11
9013	Caster_Toolbox_6" Swivel w/Brake	Dark Blue	11
9018	Caster_Mold-on Polyurethane_5" Swivel	Dark Blue	9
9019	Caster_Mold-on Polyurethane_5" Rigid	Dark Blue	9
9020	Caster_Mold-on Polyurethane_5" Swivel w/Brake	Dark Blue	9
9021	SurfaceGard_Felt_3/8" Self-Adhesive Round Pads Beige	Orange	43
9034	Caster_Soft Rubber_4" Swvl w/Brake Threaded Stem	Dark Blue	5
9040	Caster_Light Duty_2" Swivel - Stem 04 Plastic White	Dark Blue	19
9041	Caster_Light Duty_2" Swivel - Plate Plastic White	Dark Blue	19















































SKU #	Category	Color Code	Page
9045	Slide Glide + Felt Slider Assortment Movers Pack	Green	35
9046	Surface Gard Protection Kit_Large Assort. w/Storage Box	Orange	43
9048	Caster_Soft Rubber_Dual Wheel_2" - Copper Oxide Plate	Dark Blue	5
9051	Caster_Wood Light Duty_1-5/8" - Stem 02	Dark Blue	19
9052	Caster_Light Duty_1-1/4" Swivel Plate Plastic White	Dark Blue	19
9053	Caster_Light Duty_1-1/4" Swivel Stem 02 Plastic White	Dark Blue	19
9054	Caster_Light Duty_1-5/8" Swivel Plate Plastic White	Dark Blue	19
9055	Caster_Light Duty_1-5/8" Swivel Stem 02 Plastic White	Dark Blue	19
9056	Cups_2-1/8" Plastic Spike Round	Red	39
9058	Cups_2-3/8" Wood grain Effect TPR base	Red	39
9061	Caster_Hard Rubber Dual Wheel_2"	Dark Blue	6
9064	Socket_Plastic 1/2" I.D.	Dark Blue	17
9066	Socket_Plastic 5/8" I.D.	Dark Blue	17
9067	Cups_3" Rubber Round Brown	Red	39
9068	Cups_3" Rubber Round Off-White	Red	39
9069	Socket_Plastic 3/4" I.D.	Dark Blue	17
9071	Socket_Plastic 7/8" I.D.	Dark Blue	17
9072	SurfaceGard_Bumpers_Screw_Clear	Orange	43
9073	Socket_Plastic 1" I.D.	Dark Blue	17
9074	Cups_1-5/8" Rubber Square Brown	Red	39
9075	Cups_1-5/8" Rubber Round Brown	Red	39
9076	Cups_2" Rubber Square Brown	Red	39
9077	Cups_1-3/4" Rubber Round Brown	Red	39
9078	Cups_3" Rubber Square Brown	Red	39
9079	Cups_3" Carpet Base Round	Red	39
9080	Cups_1-1/2" Carpet Base Square	Red	39
9081	Cups_1-1/2" Plastic Spike Round	Red	39
9082	Cups_1-7/8" Plastic Spike Round	Red	39
9083	Cups_1-7/8" Plastic Spike Square	Red	39
9087	Cups_1-1/2" Plastic Round Clear	Red	39
9088	Cups_2" Plastic Round Clear	Red	39
9089	Cups_1-3/4" Plastic Square Clear	Red	39
9090	Cups_2" Carpet Base Round	Red	39
9091	Cups_1-3/4" Carpet Base Round	Red	39
9092	Cups_3" Carpet Base Round	Red	39
9094	GLIDES_Swivel_5/8" I.D. Brass Plated	Yellow	49
9095	GLIDES_Swivel_3/4" I.D. Brass Plated	Yellow	49
9096	GLIDES_Swivel_7/8" I.D. Brass Plated	Yellow	49
9097	GLIDES_Swivel_1" I.D. Brass Plated	Yellow	49
9098	Glide_Nail-on_1" Swivel Brass Plated	Yellow	49
9099	Glide_Nail-on_7/8" Metal Cushion	Yellow	49
9100	Glide_Nail-on_1-1/16" Metal Cushion	Yellow	49
9101	Glide_Nail-on_1-1/4" Metal Cushion	Yellow	49
9102	Glide_Plastic Tack_7/8" Plastic Cushion	Yellow	49
9103	Glide_Nail-on_1" Carpet Base	Yellow	49
9105	Leg Tip_Plastic_1/2" White	Yellow	47
9106	Leg Tip_Plastic_5/8" White	Yellow	47

SKU #	Category	Color Code	Page
9107	Leg Tip_Plastic_3/4" White	Yellow	47
9108	Leg Tip_Plastic_7/8" White	Yellow	47
9109	Leg Tip_Plastic_1" White	Yellow	47
9111	Leg Tip_Plastic_1/2" Black	Yellow	47
9112	Leg Tip_Plastic_5/8" Black	Yellow	47
9113	Leg Tip_Plastic_3/4" Black	Yellow	47
9114	Leg Tip_Plastic_7/8" Black	Yellow	47
9115	Leg Tip_Plastic_1" Black	Yellow	47
9117	Leg Tip_Rubber_1/2" White	Yellow	45
9118	Leg Tip_Rubber_5/8" White	Yellow	45
9119	Leg Tip_Rubber_3/4" White	Yellow	45
9120	Leg Tip_Rubber_7/8" White	Yellow	45
9121	Leg Tip_Rubber_1" White	Yellow	45
9122	Leg Tip_Rubber_1-1/8" White	Yellow	45
9124	Leg Tip_Rubber_1/2" Black	Yellow	45
9125	Leg Tip_Rubber_5/8" Black	Yellow	45
9126	Leg Tip_Rubber_3/4" Black	Yellow	45
9127	Leg Tip_Rubber_7/8" Black	Yellow	45
9128	Leg Tip_Rubber_1" Black	Yellow	45
9129	Leg Tip_Rubber_1-1/8" Black	Yellow	45
9131	SurfaceGard_Bumpers_7/8" Screw Off-White	Orange	43
9132	Door Stop_Rubber Wedge Brown	Yellow	51
9133	Door Stop_Heavy Duty Rubber Wedge Brown	Yellow	51
9140	FeltGard_Sliders_5" Round Pads Felt w/1/2" Black foam	Green	35
9141	FeltGard_Sliders_2-1/2" x 9" Pads Felt w/1/2" Black foam	Green	35
9142	FeltGard_Sliders_4" x 7" Pads Felt w/1/2" Black foam	Green	35
9143	Glide_Plastic Base Tack_5/8" Nail-On	Yellow	49
9144	Glide_Plastic Base Tack_3/4" Nail-On	Yellow	49
9155	Glide_Nail-on_1-1/4" Carpet Base	Yellow	49
9162	Door Stop_Rubber Wedge Off-White	Yellow	51
9163	Door Stop_Heavy Duty Rubber Wedge	Yellow	51
9165	Cups_1-1/2" Rubber Round Off-White	Red	39
9166	Cups_2" Rubber Square Off-White	Red	39
9167	Cups_1-3/4" Rubber Round Off-White	Red	39
9168	Cups_3" Rubber Square Off-White	Red	39
9174	Caster_Cast Iron_2" Swivel Plate	Blue	7
9176	Caster_Cast Iron_2-1/2" Swivel Plate	Blue	7
9180	Caster_Mold-on Poly/Steel Hubs_6" Swivel	Blue	9
9182	Caster_Cast Iron_2" Rigid	Blue	7
9184	Caster_Cast Iron_2-1/2" Rigid	Blue	7
9186	Caster_Mold-on Polyurethane/Steel Hubs_6" Swvl w/Brake	Blue	9
9187	Caster_Mold-on Polyurethane/Steel Hubs_8" Swvl w/Brake	Blue	9
9188	Caster_General Duty_1-5/8" Antique Copper Stem	Blue	19
9189	Caster_Soft Rubber_3" Swivel w/Brake - Threaded Stem	Blue	5
9190	Caster_Soft Rubber_2" Swivel w/Brake - Threaded Stem	Blue	5
9191	Caster_Soft Rubber_2-1/2" Swivel Grip ring Stem	Blue	5
9192	Caster_Soft Rubber_2" Swivel Grip ring Stem	Blue	5

SKU #	Category	Color Code	Page
9193	Caster_Soft Rubber_2" Swivel Grip ring Stem	Blue	5
9194	Caster_Soft Rubber_2" Swivel Threaded Stem	Blue	5
9195	Caster_Soft Rubber_3" Swivel Threaded Stem	Blue	5
9196	Caster_Soft Rubber_4" Swivel Threaded Stem	Blue	5
9197	Caster_Soft Rubber_2-1/2" Swivel Grip ring Stem	Blue	5
9200	Leg Tip_Vinyl_5/8" White	Yellow	46
9201	Leg Tip_Vinyl_3/4" White	Yellow	46
9202	Leg Tip_Vinyl_7/8" White	Yellow	46
9203	Leg Tip_Vinyl_1" White	Yellow	46
9204	Leg Tip_Vinyl_1-1/8" White	Yellow	46
9205	Leg Tip_Vinyl_1/2" White	Yellow	46
9206	Leg Tip_Inside_3/4" Black	Yellow	47
9207	Leg Tip_Inside_7/8" Black	Yellow	47
9208	Leg Tip_Inside_1" Black	Yellow	47
9209	Leg Tip_Inside_1-1/4" Black	Yellow	47
9210	Leg Tip_Vinyl_5/8" Black	Yellow	46
9211	Leg Tip_Vinyl_3/4" Black	Yellow	46
9212	Leg Tip_Vinyl_7/8" Black	Yellow	46
9213	Leg Tip_Vinyl_1" Black	Yellow	46
9215	Leg Tip_Vinyl_1/2" Black	Yellow	46
9219	Slide Glide_1" Leg Tip_Vinyl_Black	Green	37, 46
9220	Slide Glide_1-1/8" Leg Tip_Vinyl_Black	Green	37, 46
9221	Slide Glide_Cup_1-3/8" I.D.	Green	37
9222	Slide Glide_Cup_2-3/4" I.D.	Green	37
9223	Leg Tip_Rubber_1-1/4" White	Yellow	45
9224	Leg Tip_Rubber_1-1/4" Black	Yellow	45
9225	Leg Tip_Rubber_1-1/2" White	Yellow	45
9226	Leg Tip_Rubber_1-1/2" Black	Yellow	45
9234	Leg Tip_Plastic_1" Square Black	Yellow	46
9235	Leg Tip_Inside_3/4" Black	Yellow	47
9236	Leg Tip_Inside_7/8" Black	Yellow	47
9237	Leg Tip_Inside_1" Black	Yellow	47
9238	Leg Tip_Angle_3/4" Black	Yellow	47
9239	Leg Tip_Angle_7/8" Black	Yellow	47
9240	Slide Glide_1" Square Pads w/ Screws	Green	37
9241	Slide Glide_1" x 4" Pads Self-Adhesive	Green	37
9242	Slide Glide_1-3/8" Square Pad w/Screws	Green	37
9243	Slide Glide_2" x 2" x 2-1/2" Triangle Pad w/Screws	Green	37
9244	Slide Glide_2-1/8" Square Pads w/Screws	Green	37
9245	Caster_Polyamide_5" Swivel	Blue	10
9246	Caster_Polyamide_5" Rigid	Blue	10
9247	Caster_Polyamide_5" Swvl w/Brake	Blue	10
9248	Slide Glide_2-3/4" Round Pads w/Screws	Green	37
9249	Slide Glide_1-1/4" Nail-On Pads	Green	37
9260	Caster_Blue Elastic Rubber_4" Swivel	Blue	6
9261	Caster_Blue Elastic Rubber_4" Rigid	Blue	6
9262	Caster_Blue Elastic Rubber_4" Swvl w/Brake	Blue	6

SKU #	Category	Color Code	Page	SKU #	Category	Color Code	Page
9263	Caster_Elastic Soft Rubber_5" Swivel	■	6	9364	Cups_2-1/8" Wood Effect Felt Base	■	39
9264	Caster_Elastic Soft Rubber_5" Rigid	■	6	9369	FeltGard Plus Slider pads_3" Store & Reuse	■	35
9265	Caster_Elastic Soft Rubber_5" Swvl w/Brake	■	6	9388	Caster_Polypropylene_5" Swivel	■	7
9270	Caster_Hard Rubber_2" Swivel	■	6	9389	Caster_Polypropylene_5" Rigid	■	7
9271	Caster_Hard Rubber_2" Swvl w/Brake	■	6	9392	Caster_Polypropylene_2" Swivel Plate	■	7
9272	Caster_Hard Rubber_2" Rigid	■	6	9393	Caster_Polypropylene_2-1/2" Swivel Plate	■	7
9273	Caster_Hard Rubber_2-1/2" Swivel	■	6	9394	Caster_Polypropylene_3" Swivel Plate	■	7
9274	Caster_Hard Rubber_2-1/2" Swvl w/Brake	■	6	9395	Caster_Polypropylene_4" Swivel Plate	■	7
9275	Caster_Hard Rubber_2-1/2" Rigid	■	6	9396	Caster_Polypropylene_2" Rigid	■	7
9276	Caster_Hard Rubber_3" Swivel	■	6	9397	Caster_Polypropylene_2-1/2" Rigid	■	7
9277	Caster_Hard Rubber_3" Swvl w/Brake	■	6	9398	Caster_Polypropylene_3" Rigid	■	7
9278	Caster_Hard Rubber_3" Rigid	■	6	9399	Caster_Polypropylene_4" Rigid	■	7
9279	Caster_Hard Rubber_4" Swivel	■	6	9401	Caster_Twin Wheel_1-5/8" Swivel Plate	■	20
9280	Caster_Hard Rubber_4" Swvl w/Brake	■	6	9402	Caster_Twin Wheel_1-5/8" Swivel Stem	■	20
9281	Caster_Hard Rubber_4" Rigid	■	6	9403	Caster_Twin Wheel_2" Swivel Plate	■	20
9283	Move-it_HOME Series_4" Tri-dolly	■	27	9404	Caster_Twin Wheel_2" Swivel Stem	■	20
9285	Caster_Semi-Elastic Rubber_3" Swivel	■	6	9405	Caster_Twin Wheel_2" Swivel Plate	■	20
9286	Caster_Semi-Elastic Rubber_3" Rigid	■	6	9406	Caster_Twin Wheel_2" Swivel Stem	■	20
9287	Caster_Semi-Elastic Rubber_3" Swvl w/Brake	■	6	9407	FeltGard Plus Slider pads_3-1/2" Round	■	35
9288	Caster_Semi-Elastic Rubber_4" Swivel	■	6	9408	FeltGard Plus Slider pads_2-1/2" Round	■	35
9289	Caster_Semi-Elastic Rubber_4" Rigid	■	6	9417	Caster_Twin Wheel_2" Swivel Plate	■	20
9290	Caster_Semi-Elastic Rubber_4" Swvl w/Brake	■	6	9418	Caster_Twin Wheel_2" Swivel Stem	■	20
9291	Caster_Semi-Elastic Rubber_5" Swivel	■	6	9419	Caster_Twin Wheel_2" Swivel Stem	■	20
9292	Caster_Semi-Elastic Rubber_5" Rigid	■	6	9420	Caster_Twin Wheel_1-5/8" U-Bracket	■	20
9293	Caster_Semi-Elastic Rubber_5" Swvl w/Brake	■	6	9421	Felt_Light Duty_3/8" Pads Round Green	■	43
9298	Dolly_Snowmobile	■	55	9422	Caster_PU on Polypropylene Hub_6" Swivel	■	9
9299	Move-it_HOME Series_6" Tri-dolly	■	27	9423	Felt_Light Duty_Pad Assortment Round Green	■	43
9314	Slide Glide_5" Furniture Slide w/Fleece Socks	■	35	9424	Caster_PU on Polypropylene Hub_6" Rigid	■	9
9316	Slide Glide_4" Furniture Slide	■	35	9425	Felt_Light Duty_Pad Assortment Round Brown	■	43
9333	Door Stop_Wedge Designer Wood Effect	■	51	9427	Felt_Medium Duty_4-1/4" x 6" Blanket Green	■	43
9335	Slide Glide_3" x 3" Mover's Pad Black Square	■	35	9428	Caster_Twin Wheel_2" Swivel Stem	■	20
9336	Slide Glide_3" x 3" Mover's Pad Almond Square	■	35	9431	FeltGard Plus Slider pads_5-3/4" x 8-1/4" Store & Reuse	■	35
9337	Slide Glide_3" x 3" Mover Pad White Square	■	35	9433	Felt_Light Duty_6" x 18" Blanket Green	■	43
9338	Slide Glide_5-3/4" x 8-1/4" Mover Pad	■	35	9435	Wedge-it_Plastic Shims	■	51
9344	Caster_Rubber_2" Swivel Threaded Stem	■	19	9436	Wedge-it_Plastic Shims Bulk Jar	■	51
9345	Caster_Medium Duty_2" Swivel Stem	■	19	9439	Socket_Metal 3/8" I.D.	■	17
9346	Caster_Medium Duty_2" Swivel Plate	■	19	9440	Socket_Plastic 3/8" I.D.	■	17
9347	Caster_Medium Duty_1-5/8" Swivel Stem	■	19	9441	Caster_Appliance_7/8" Dual Wheel w/Threaded Stem	■	18
9348	Caster_Medium Duty_1-5/8" Swivel Plate	■	19	9442	Move-it_HOME Series_12" Tri-dolly	■	27
9352	Caster_Hooded Ball_1-5/8" Bright Brass Stem	■	18	9444	Glide_1-1/4" Phenolic w/Threaded Stem	■	49
9353	Caster_Hooded Ball_1-5/8" Bright Brass Plate	■	18	9445	Glide_5/8" Plastic Cushion Nail-On	■	49
9354	Caster_Hooded Ball_2" Bright Brass Stem	■	18	9446	Glide_3/4" Plastic Cushion Nail-On	■	49
9355	Caster_Hooded Ball_2" Bright Brass Plate	■	18	9447	Glide_7/8" Plastic Cushion Nail-On	■	49
9358	Caster_Hooded Ball_2" Bright Chrome Stem	■	18	9448	Glide_1-1/8" Plastic Cushion Nail-On	■	49
9359	Caster_Hooded Ball_2" Bright Chrome Plate	■	18	9449	Glide_7/8" Metal Cushion w/Threaded Stem	■	49
9360	Caster_Hooded Ball_2" Bright Chrome Stem	■	18	9450	Glide_1-1/8" Metal Cushion w/Threaded Stem	■	49
9363	Cups_1-3/4" Wood Effect Felt Base	■	39	9451	Glide_1-1/4" Metal Cushion w/Threaded Stem	■	49

SKU #	Category	Color Code	Page
9452	Slide Glide_1" Pads w/Screws		37
9453	Slide Glide_2" Pads w/Screws		37
9454	Slide Glide_2-1/2" Pads w/Screws		37
9455	Slide Glide_1-1/2" Pads w/Screws		37
9456	Slide Glide_7/8" Pads w/Screws		37
9457	Slide Glide_5/8" x 3" Pads Strips		37
9468	Slide Glide_1-1/2" Hex Based Appliance w/ Threaded Stem		37
9469	Slide Glide_7/8" Nail On Pad		37
9471	Slide Glide_1" + 1-1/2" Dinette Set (4 Chairs + 1 Table)		37
9477	Caster_Soft Rubber_2" Swivel Plate		5
9478	Caster_Soft Rubber_2-1/2" Swivel Plate		5
9479	Caster_Soft Rubber_3" Swivel Plate		5
9480	Caster_Soft Rubber_4" Swivel Plate		5
9481	Caster_Soft Rubber_2" Rigid		5
9482	Caster_Soft Rubber_2-1/2" Rigid		5
9483	Caster_Soft Rubber_3" Rigid		5
9484	Caster_Soft Rubber_4" Rigid		5
9485	WonderLevel_Glide Pack for uneven floors		49
9487	Caster_Soft Rubber_1-1/4" Swivel Plate		5
9488	Caster_Soft Rubber_1-1/4" Rigid		5
9489	Caster_Soft Rubber_1-1/2" Swivel Plate		5
9490	Caster_Soft Rubber_1-1/2" Rigid		5
9491	Caster_Soft Rubber_6" Swivel		5
9492	Caster_Soft Rubber_6" Rigid		5
9493	Caster_Mold-On Rubber_6" Swivel Plate		10
9494	Caster_Mold-On Rubber_6" Rigid		10
9496	Caster_Soft Rubber_3" Swivel w/Brake Threaded Stem		5
9498	Door Stop_Spring_Nickel		51
9500	Door Stop_Spring_Brass		51
9508	Caster_Soft Rubber_6" Swivel Plate w/Brake		5
9509	Caster_Soft Rubber_2" Swivel Plate w/Brake		5
9510	Caster_Soft Rubber_2-1/2" Swivel Plate w/Brake		5
9511	Caster_Soft Rubber_3" Swivel Plate w/Brake		5
9512	Caster_Soft Rubber_4" Swivel Plate w/Brake		5
9513	Glide_1-1/2" Nail-On_Plastic		49
9516	Caster_Hooded Ball_2" Bright Brass Stem		18
9517	Caster_Hooded Ball_2" Bright Brass Plate		18
9518	Caster_Bed Roller_2-1/8" Soft Tread w/Brake		17
9523	Bed Riser_6-1/8" Molded Black		17
9532	Caster_Bed Roller_2-1/8" Adjustable w/Brake		17
9535	Caster_Bed Roller_2-1/8" Swivel		17
9536	Caster_Bed Roller_2-1/8" Swvl w/Brake		17
9541	Caster_Polypropylene_2" Swivel Plate w/Brake		7
9543	Caster_Polypropylene_3" Swivel Plate w/Brake		7
9546	Lazy Susan_3" Metal_Square		55
9547	Lazy Susan_4" Metal_Square		55
9548	Lazy Susan_6" Metal_Square		55

SKU #	Category	Color Code	Page
9549	Lazy Susan_12" Metal_Round		55
9551	Wall Protectors_3-1/4" Paintable White Disc		51
9552	Wall Protectors_5" Paintable White Disc		51
9556	Caster_Light Duty_1-1/4" Plastic Wheel Black - Plate		19
9557	Caster_Light Duty_1-1/4" Plastic Wheel Black - Stem		19
9558	Caster_Light Duty_1-5/8" Plastic Wheel Black - Plate		19
9559	Caster_Light Duty_1-5/8" Plastic Wheel Black - Stem		19
9560	SurfaceGard_Bumpers_1/2" Vinyl White - Square		43
9561	SurfaceGard_Bumpers_1/2" Vinyl Brown - Square		43
9562	SurfaceGard_Bumpers_1/2" Vinyl Clear - Square		43
9563	SurfaceGard_Bumpers_3/4" Vinyl White - Square		43
9564	SurfaceGard_Bumpers_3/4" Vinyl Brown - Square		43
9565	SurfaceGard_Bumpers_3/4" Vinyl Clear - Square		43
9568	Door Stop_Cushion White		51
9573	Door Stop_Cushion Clear		51
9584	Wheel_12" Semi-Pneumatic Rubber Metal Hub		24
9589	Wheel_6" Semi-Pneumatic Rubber Metal Hub		24
9590	Wheel_6" Semi-Pneumatic Rubber Metal Hub		24
9591	Wheel_6" Semi-Pneumatic Rubber Metal Hub		24
9592	Wheel_7" Semi-Pneumatic Rubber Metal Hub		24
9593	Wheel_7" Semi-Pneumatic Rubber Metal Hub		24
9594	Wheel_8" Semi-Pneumatic Rubber Metal Hub		24
9595	Wheel_8" Semi-Pneumatic Rubber Metal Hub		24
9596	Wheel_10" Semi-Pneumatic Rubber Metal Hub		24
9597	Wheel_10" Semi-Pneumatic Rubber Metal Hub		24
9599	Wheel_8" Semi-Pneumatic Rubber Metal Hub		24
9600	Wheel_8" Hand Truck 5/8" Off-Center Bore		24
9601	Appliance Roller_Stamped Steel_Adjustable		18
9602	Wheel_10" Hand Truck 5/8" Off-Center Bore		24
9603	Appliance Roller_Aluminum_Adjustable		18
9606	Wheel_16" Wheelbarrow Inner Tube		25
9610	Wheel_6" Semi-Pneumatic Rbbr Plastic Hub		24
9611	Wheel_7" Semi-Pneumatic Rbbr Plastic Hub		24
9613	Wheel_8" Semi-Pneumatic Rbbr Plastic Hub		24
9614	Wheel_8" Semi-Pneumatic Rbbr Plastic Hub		24
9615	Wheel_10" Semi-Pneumatic Rbbr Plastic Hub		24
9629	Caster_Soft Rubber_4" Swivel Plate		5
9630	Caster_Soft Rubber_4" Swivel w/Brake Plate		5
9634	Wheel_10" Semi-Pneumatic Rubber Metal Hub		25
9636	Wheel_8" Semi-Pneumatic Rubber Metal Hub		24
9644	SurfaceGrip_1" Anti-Skid Disc		41
9645	SurfaceGrip_1-1/2" Anti-Skid Disc		41
9646	SurfaceGrip_2" Anti-Skid Disc		41
9647	SurfaceGrip_2-1/2" Anti-Skid Disc		41
9653	Wheel_12" Hand Truck 3/4" Center Bore		24
9654	Wheel_12" Hand Truck 5/8" Center Bore		24
9659	Caster_Soft Rubber_4" Rigid		5

SKU #	Category	Color Code	Page
9672	Caster_Twin Wheel_ 2" Swivel Stem - Black	■	20
9673	Caster_Twin Wheel_ 2" Swivel Stem - Black	■	20
9674	Caster_Twin Wheel_ 2" Swivel Stem - Black	■	20
9685	Caster_Hooded Ball_2" Bright Chrome Stem	■	18
9686	Caster_Hooded Ball_2" Bright Chrome Stem	■	18
9694	Caster_Twin Wheel_ 2" Swivel Stem - Black	■	20
9702	Wheel_7" Semi-Pneumatic Rubber Metal Hub	■	24
9703	Wheel_6" Semi-Pneumatic Rubber Metal Hub	■	24
9704	Wheel_10" Flat Free Tire 5/8" Off-Center Bore	■	24
9708	Wheel_15" Flat Free Tire 5/8" Center Bore	■	25
9709	Wheel_14.33" Flat Free Tire Universal Bore	■	25
9721	Caster_Hooded Ball_2" Swivel Bright Chrome Plate	■	18
9722	Caster_Hooded Ball_2" Swivel Bright Chrome Stem	■	18
9733	Caster_Twin Wheel_ 2" Swivel Stem - Black	■	20
9735	Caster_TPR_4" Swivel Plate	■	8
9736	Caster_TPR_4" Swivel Plate w/Brake	■	8
9737	Caster_TPR_4" Rigid	■	8
9738	Caster_TPR_5" Swivel Plate	■	8
9739	Caster_TPR_5" Swivel Plate w/Brake	■	8
9740	Caster_TPR_5" Rigid	■	8
9741	Caster_Twin Wheel_ 2" Swivel Stem - Black	■	20
9742	Crutch Tip_Rubber_ 3/4" - 7/8"	■	45
9743	Leg Tip_Rubber_ 1-1/4" Off-White	■	45
9744	Leg Tip_Plastic_1-1/8" White	■	47
9745	Leg Tip_Plastic_1-1/4" White	■	47
9746	Leg Tip_Rubber_1-1/4" Black	■	45
9751	Leg Tip_Rubber_ 1/2" Off-White	■	45
9752	Leg Tip_Rubber_ 5/8" Off-White	■	45
9753	Leg Tip_Rubber_ 3/4" Off-White	■	45
9754	Leg Tip_Rubber_ 7/8" Off-White	■	45
9755	Leg Tip_Rubber_1" Off-White	■	45
9756	Leg Tip_Rubber_ 1-1/8" Off-White	■	45
9758	Leg Tip_Rubber_1/2" Black	■	45
9759	Leg Tip_Rubber_5/8" Black	■	45
9760	Leg Tip_Rubber_ 3/4" Black	■	45
9761	Leg Tip_Rubber_ 7/8" Black	■	45
9762	Leg Tip_Rubber_1" Black	■	45
9763	Leg Tip_Rubber_ 1-1/8" Black	■	45
9766	Leg Tip_Rubber_ 1-1/2" Black	■	45
9768	Leg Tip_Plastic_ 1-1/8" Black	■	47
9769	Leg Tip_Plastic_ 1-1/4" Black	■	47
9770	Caster_Phenolic_4" Swivel	■	10
9771	Caster_Phenolic_4" Rigid	■	10
9774	Caster_Phenolic_6" Swivel	■	10
9775	Caster_Phenolic_6" Rigid	■	10
9776	Caster_Phenolic_10" Swivel	■	10
9777	Caster_Phenolic_8" Rigid	■	10

SKU #	Category	Color Code	Page
9778	Caster_Phenolic_6" Swivel w/Brake	■	10
9779	Caster_Phenolic_4" Swivel w/Brake	■	10
9780	Caster_Cast Iron_3" Swivel	■	7
9781	Caster_Cast Iron_3" Rigid	■	7
9782	Caster_Cast Iron_4" Swivel	■	7
9783	Caster_Cast Iron_4" Rigid	■	7
9784	Caster_Polypropylene_ 4" Swivel	■	7
9785	Caster_Gate Hard Rubber_4" Swivel Spring Loaded	■	11
9786	Caster_Polypropylene_ 4" Swivel	■	7
9787	Caster_Soft Rubber_ 5" Swivel	■	5
9788	Caster_Soft Rubber_5" Swivel w/Brake	■	5
9789	Caster_Soft Rubber_5" Rigid	■	5
9790	Caster_TPR_2" Swivel - Stem	■	8
9793	Wheel_10" Pneumatic	■	25
9794	Caster_Pneumatic_8" Swivel	■	11
9795	Caster_Pneumatic_8" Rigid	■	11
9796	Caster_Pneumatic_10" Swivel	■	11
9797	Caster_Pneumatic_10" Rigid	■	11
9798	Caster_Gate Pneumatic_8" Swivel Spring Loaded	■	11
9799	Caster_Polypropylene_4" Swivel w/Brake	■	9
9805	Caster_TPR_4" Swivel Medium Duty	■	8
9807	Caster_TPR_3" Swivel Grip-ring Stem	■	8
9810	Caster_TPR_5" Swivel	■	8
9811	Caster_TPR_5" Rigid	■	8
9813	Caster_TPR_8" Rigid	■	8
9815	FeltGard_Heavy Duty_ 1" Square Pad	■	31
9816	FeltGard_Heavy Duty_ 1-1/2" x 1-1/2" L-Shape Corner Pad	■	31
9818	FeltGard_Heavy Duty_ 1/2" x 58" Roll	■	31
9819	FeltGard_Heavy Duty_ 1" Round Pad w/ Nylon Insert	■	32
9820	SurfaceGard_Felt_ Medium-Duty 1/2" Round Green Pads	■	43
9821	SurfaceGard_Felt_ Medium-Duty 3/4" Round Green Pads	■	43
9822	SurfaceGard_Felt_ Medium-Duty 1" Round Brown Pads	■	43
9823	SurfaceGard_Felt_ Medium-Duty 1" Square Brown Pads	■	43
9824	FeltGard_Heavy Duty Felt Pad Combo	■	32
9825	FeltGard PLUS_Cup 1" Round	■	32
9826	FeltGard PLUS_Cup 1-1/2" Round	■	32
9827	FeltGard PLUS_Cup 2" Round	■	32
9828	FeltGard PLUS_Cup 2-1/2" Round	■	32
9829	FeltGard PLUS_Cup 1-1/2" Square	■	32
9832	FeltGard_Heavy Duty_ 3/4" Square Pad	■	32
9839	FeltGard_Heavy Duty_ Value pack Assortment	■	32
9840	FeltGard_Heavy Duty_ 3/4" felt w/ nylon discs + drill bit	■	32
9841	FeltGard_Heavy Duty_ 1" felt w/ nylon discs + drill bit	■	32
9842	FeltGard_Heavy Duty_ 1-1/2" felt w/ nylon discs + drill bit	■	32
9843	FeltGard_HD_ 1" + 1-1/2" felt w/ nylon discs + drill bit	■	32
9844	FeltGard_HD_ 1"x 3-3/4" felt w/ nylon discs	■	32
9845	FeltGard_HD_ 1"x 3-3/4" felt w/ nylon discs + drill bit	■	32

SKU #	Category	Color Code	Page
9846	Move-it_PREMIER Series_24" x 36" Platform Cart	Black	27
9847	Move-it_HOME Series_19" x 29" Platform Cart	Black	27
9848	Appliance Rollers_Plastic 19" x 28"	Blue	18
9850	Move-it_PREMIER Series_20" x 31" Dolly	Black	27
9851	MOVERS BLANKET_72" X 80"	Black	27
9852	FeltGard_Heavy Duty_1" Pads Round	Blue	31
9854	Move-it_PREMIUM Series_12" x 18" Wood Top Dolly	Black	27
9855	3-in-1 VALUE PACK Assortment - 4" Pads & Cups	Green	35
9858	Caster_Polypropylene 4" Swivel Plate w/Brake	Blue	7
9860	FeltGard_Heavy Duty_4-1/4" x 6" Sheet Brown	Blue	31
9861	FeltGard_Heavy Duty_3/4" Round Pad Brown	Blue	31
9862	FeltGard_Heavy Duty_1" Round Pad Brown	Blue	31
9863	FeltGard_Heavy Duty_1-1/2" Pad Brown	Blue	31
9864	FeltGard_Heavy Duty_1" Square Pad Brown	Blue	31
9865	FeltGard_Heavy Duty_1/2" x 2-5/8" Strip Pad Brown	Blue	31
9866	FeltGard_Heavy Duty_1" x 3-3/4" Rectangle Pad Brown	Blue	31
9867	FeltGard_Heavy Duty_2" Round Pad Brown	Blue	31
9868	FeltGard_Heavy Duty_3" Round Pad Brown	Blue	31
9873	FeltGard_Heavy Duty_1" Round Pad Brown Bonus Pack	Blue	31
9877	FeltGard_Heavy Duty_1-1/2" Pad Brown Bonus Pack	Blue	31
9882	FeltGard_Heavy Duty_1" Round Pad Value Pack 96 pcs.	Blue	31
9892	FeltGard_Heavy Duty Hook & Loop Felt Pads_1-1/2"	Blue	32
9908	FeltGard Plus_Glide 1" Almond w/Threaded Stem 1/4"	Blue	32
9909	FeltGard Plus_Glide 1-1/2" Almond w/Threaded Stem 1/4"	Blue	32
9910	FeltGard_Heavy Duty_7/8" Nail-on Pads	Blue	32
9911	FeltGard_Heavy Duty_1-1/2" Nail-on Pads	Blue	32
9915	Self-Leveling Felt_Heavy Duty_1" Pads	Blue	31
9916	Self-Leveling Felt_Heavy Duty_1-1/2" Pads	Blue	31
9918	FeltGard_Heavy Duty_1" Nail-on Pads	Blue	32
9921	FeltGard_Heavy Duty_1-1/4" Pad Beige	Blue	31
9927	FeltGard_Heavy Duty_2" Pad Beige	Blue	31
9928	FeltGard_Heavy Duty_3" Pad Beige	Blue	31
9930	FeltGard_Heavy Duty Hook & Loop Felt Pads_3/4"	Blue	32
9931	FeltGard_Heavy Duty Hook & Loop Felt Pads_1"	Blue	32
9933	FeltGard PLUS_7/8" Glide w/Hollow Nail Almond	Blue	32
9934	FeltGard PLUS_1" Glide w/Hollow Nail Almond	Blue	32
9935	FeltGard PLUS_1-1/2" Glide w/Hollow Nail Almond	Blue	32
9936	FeltGard_Heavy Duty Felt_Nail-on Pads - Dinette Set	Blue	32
9936 _{ns}	FeltGard_Heavy Duty Felt_Nail-on Pads - Dinette Set	Blue	32
9937	FeltGard_Heavy Duty_1/2" x 2-5/8" Strip Pad	Blue	31
9938	FeltGard PLUS_Glide Swivel 1" Brass Almond Felt	Blue	32
9939	FeltGard_Heavy Duty_Nail-on Pads Combo	Blue	32
9941	SurfaceGard_General-Duty Value Pack	Orange	43
9943	SurfaceGard_Multi-pak combo Cork, Foam, Vinyl Pads	Orange	43
9943D	SurfaceGard_Multi-pak combo Cork, Foam, Vinyl Pads	Orange	43
9947	FeltGard_Heavy Duty Assortment	Blue	31
9948	FeltGard_Heavy Duty_2" x 4" Sheets	Blue	31

SKU #	Category	Color Code	Page
9949	SurfaceGard_Felt_Medium-Duty 3/8" Round Brown Pads	Orange	43
9950	FeltGard_Heavy Duty_4-1/4" x 6" Sheet	Blue	31
9951	FeltGard_Heavy Duty_3/4" Round Pad Beige	Blue	31
9952	FeltGard_Heavy Duty_1" Round Pad Beige	Blue	31
9953	FeltGard_Heavy Duty_1-1/2" Round Pad Beige	Blue	31
9954	FeltGard_Heavy Duty_1/2" x 6" Strip Pad	Blue	31
9955	FeltGard_Heavy Duty_1" Pad w/ 1-1/8" Glide	Blue	32
9956	SurfaceGard_Felt_Medium-Duty 4-1/4" x 6" Brown Sheet	Orange	43
9957	SurfaceGard_Felt_Medium-Duty 3/8" Round White Pad	Orange	43
9958	SurfaceGard_Felt_Medium-Duty 1/2" Round Brown Pads	Orange	43
9959	SurfaceGard_Felt_Medium-Duty 3/4" Round Brown Pads	Orange	43
9960	SurfaceGard_Felt_Medium-Duty 3/4" Square Brown Pads	Orange	43
9961	SurfaceGard_Cork_3/4" Pads Round	Orange	43
9962	SurfaceGard_Cork_1/2" Pads Round	Orange	43
9963	SurfaceGard_1/2" x 1" Pads Rectangle Clear	Orange	43
9964	SurfaceGard_Disc_3/8" Pads Round Clear	Orange	43
9965	SurfaceGard_Disc_3/4" Pads Round Clear	Orange	43
9966	SurfaceGard_Disc_3/4" Pads Round Clear Non-Adhesive	Orange	43
9967	SurfaceGard_Disc_1/2" Pads Round Clear	Orange	43
9969	SurfaceGard_Value Pack 36 pcs.	Orange	43
9969 _{ns}	SurfaceGard_Value Pack 36 pcs.	Orange	43
9970	SurfaceGrip_Foam Anti-Skid Pads 2" Round	Light Blue	41
9971	SurfaceGrip_Foam Anti-Skid Pads 1-1/2" Round	Light Blue	41
9972	FeltGard_Heavy Duty_1" Pad Bonus Pack	Blue	31
9973	SurfaceGard_Foam_3/4" Round Pads	Orange	43
9974	SurfaceGard_Foam_1/2" Round Pads	Orange	43
9976	FeltGard_Heavy Duty_1-1/2" Pad Bonus Pack	Blue	31
9980	SurfaceGard_Foam_3/8" X 2-3/8" Strip	Orange	43



Best On the Floor!
shepherd
HARDWARE PRODUCTS

Three Oaks, Michigan

Terms of Payment

Net thirty (30) days from date of invoice with approved credit.

Minimum Prepaid Freight Order

\$500 minimum order for prepaid freight (standard ground) within the continental US for established accounts. Orders will be adjusted to conform to standard packaging quantities.

Product Specification

We reserve the right to adjust product specification in line with our policy of continuous development.

Return Merchandise

Written authorization must be obtained from Shepherd Hardware Products LLC before merchandise may be returned. All merchandise must be shipped on a pre-paid basis and is subject to a 20% handling charge.

Claims

Claims for shortage of goods must be made within three (3) working days from receipt of goods.

Pricing

Prices may be subject to change without prior notice.

Order Acknowledgement

Confirmation/acknowledgement of order receipt is not sent as standard procedure.

Overdue Accounts

We reserve the right to charge a late fee of 1.5% per month on the unpaid total balance due when more than thirty (30) days past due.

shepherd
HARDWARE PRODUCTS

www.shepherdhardware.com



Printed in USA 042019



A COLSON ASSOCIATE