

Introducing  
**GEN II**

**THE  
ULTIMATE  
FASTENERS**



**AXIS™**

STRUCTURAL WOOD SCREWS



**EPIC™**

TRIM HEAD SCREWS



**PICO™**

FINISH HEAD SCREWS



**NOVA™**

STRUCTURAL LAG SCREW



**YUKON™**

STRUCTURAL HEX LAGS



**AURA™**

FOR CABINETRY & MORE



**MORE INSIDE!**

- For Drywall & Cement Board
- Specialty Screws
- Bit Holders & Star Drive Bits
- Other Accessories

**ROCO™**

WOOD TO STEEL SCREWS

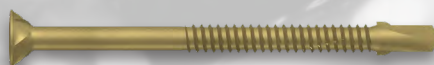

**FOR DECKING**

- Composite Deck Screws
- DeckLok & RailLok Brackets
- Hidden Deck Fasteners
- Deck2Wall Spacers

**WWW.SCREW-PRODUCTS.COM**

9401 Bujacich Rd. Bldg 1B, Gig Harbor, WA 98332  
Toll-Free 1-877-844-8880

**THE ULTIMATE FASTENERS**

FOLLOW US



#SCREWPRODUCTSINC

Nov 15, 2020

# Introducing GEN II



# THE ULTIMATE FASTENERS

## TABLE OF CONTENTS

<b>AXIS</b>		AXIS™ General Interior Structural Wood Screw	1" to 6"	4
		AXIS™ General Exterior Structural Wood Screw	3/4" to 8"	6
		AXIS™ Stainless Steel Structural Wood Screw	1" to 4"	8
<b>EPIC</b>		EPIC™ General Exterior Trim Screw	1-5/8" to 5"	10
		EPIC™ Stainless Steel Trim Screw	1-5/8" to 4"	12
<b>PICO</b>		PICO™ General Exterior Finish Screw	1-5/8" to 3"	14
		PICO™ Stainless Steel Finish Screw	1-5/8" to 3"	16
<b>AURA</b>		AURA™ For Cabinetry & More! Exterior/Interior	1" to 3"	18
<b>NOVA</b>		NOVA™ General Exterior Structural Lag Screw	1" to 16"	20
<b>YUKON</b>		YUKON™ General Exterior Structural Hex Lag	4" to 14"	22
<b>ROCO</b>		ROCO™ Wood to Steel General Exterior	1-1/2" to 4-3/4"	26
		C-Deck Composite Deck Screws	2-3/4"	28
		Phillips Drywall Screws - Drill & Sharp Point	1-1/8" to 3"	31
		Coated Cement Board - Sharp & Drill Point	1-1/4" to 1-5/8"	32
		Tapcon Masonry Screws	1-3/4" to 3-1/4"	32

**Decking Hardware Pg 29-30**

**Specialty Screws Pg 30-32**

**Accessories & More! Pg 33-34**

- DeckLok® Lateral Anchor System
- RailLok® Railing & Fence Bracket
- The Ultimate Hidden Deck Fastener
- D2W™ Deck2Wall Spacers

- Gutter Screws
- Phillips Mod Truss Metal to Metal
- M2M Metal To Metal Screws

- WINBAG® Inflatable Reusable Shims
- Star Drive Bits & Bit Holders
- HOLDSaBIT Bit Holder

**WWW.SCREW-PRODUCTS.COM**

9401 Bujacich Rd. Bldg 1B, Gig Harbor, WA 98332  
Toll-Free 1-877-844-8880

Weights and counts subject to change without notice.

**THE ULTIMATE FASTENERS**

2

FOLLOW US



#SCREWPRODUCTSINC

Nov 15, 2020

Introducing  
**GEN II**



**THE  
ULTIMATE  
FASTENERS**

**SUPERIOR COATINGS**



**INT**

**Typical Interior Use**

Corrosion Protection:  
**Medium**

Typical heated, dry room environments with clean air (low or no condensation / minimal outdoor exposure) such as homes, shops, offices, schools, hotels, etc. Environmentally friendlier than any Yellow Zinc that contains Chromium 6.

- ZYTEC™+



**EXT**

**Typical Exterior Use**

Corrosion Protection:  
**High**

Compatible with most above ground pressure treated lumber. For ground contact treated lumber, areas within one mile of saltwater, near swimming pools, exposure to corrosive chemicals, or other areas where corrosion is more like to occur, use proper grade **Stainless Steel**.

- ZYTEC™ GX
- ZYTEC™ XT



**SS**

**Tough Environments**

Corrosion Protection:  
**Very High**

Outdoor coastal areas, surfaces with salt exposure, shipyards, ground contact treated lumber, medium polluted industrial areas, chemical plants, etc.

- 316 STAINLESS STEEL
- STAINLESS STEEL \*

\* Our Gen II Products marked "Stainless Steel" are Austenitic Stainless Steel AISI 305 or better!

**Always follow timber manufacturer's recommendations for fasteners!**

**WWW.SCREW-PRODUCTS.COM**  
9401 Bujacich Rd. Bldg 1B, Gig Harbor, WA 98332  
Toll-Free 1-877-844-8880

Weights and counts subject to change without notice.

**THE ULTIMATE FASTENERS**

FOLLOW US  
  
#SCREWPRODUCTSINC

Introducing  
**GEN II**



**THE  
ULTIMATE  
FASTENERS**

**INTERIOR**

**STRUCTURAL**

**AXIS™**



**Horizon Curve™**

A slight curvature of the head for elegant, professional, architectural results. The Finish Ring underneath the head also provides a better finish by cutting the top fibers in the wood for an extra step in countersinking.



**Turbine Ribs™**

(patent pending) Turbine Ribs cut quickly into the wood, leaving a professional, clean finish with maximum wood contact. The cup shaped, countersinking head provides increased holding power and reduced risk of splitting.



**Twin Blades™**

(patent pending) This set of knurls cuts fast to dramatically reduce friction and heat on the shank, while reducing load on the drill. They also provide better performance by removing debris faster than a standard fastener's knurl.



**Fast Start Tip**

With sharp threads all the way to the tip, the fastener has an immediate grip for a fast start. The inset thread cut drastically reduces the splitting effect and minimizes the driving torque needed to engage the wood.

This advanced, General Purpose Structural Wood Screw is for typical interior, medium-corrosive environments. Use them on any size job or project from framing to small wood working!



Available in 1lb, 5lb and 1/4 Keg  
All Packaging Includes Drive Bit!

**WWW.SCREW-PRODUCTS.COM**

9401 Bujacich Rd. Bldg 1B, Gig Harbor, WA 98332  
Toll-Free 1-877-844-8880

Weights and counts subject to change without notice.

**THE ULTIMATE FASTENERS**

4

FOLLOW US



#SCREWPRODUCTSINC

Nov 15, 2020



# THE ULTIMATE FASTENERS

## INTERIOR

## STRUCTURAL

The AXIS™ Structural Wood Screw is the next step in fastener design. Every facet has been evaluated and improved (patents pending). Our extra sharp Fast Start Tip saves you time onsite and the Twin Blades outperform the competitor's knurls. The Turbine Ribbs ensure an incredibly clean finish. Its cup shaped, countersinking head, provides unparalleled holding power and less risk of splitting the wood. The Horizon Curve Head has been architecturally engineered to leave an elegant finish.

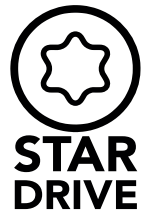

Sizes Available: #8 x 1" to #10 x 6"



### TYPICAL INTERIOR USE

**ZYTEC™+ Coating:** Typical heated, dry room environments with clean air (low or no condensation/minimal outdoor exposure) such as homes, shops, offices, schools, hotels, etc. Environmentally friendlier than any Yellow Zinc that contains Chromium 6. Always follow timber manufacturer's recommendations for fasteners.

### Common Applications

- Commercial & residential
- General indoor jobs
- Remodeling and repair
- Interior framing
- Trim work & Cabinetry
- Windows and doors
- Post and beam & much more!

General Info				
Type of Screw	General Purpose Structural Wood			
Material	Heat Treated, Hardened Steel			
Coating	ZYTEC™ +			
Head Style	Countersinking TX20 Star Drive			
Point Type	Modified Type 17			
Construction		#8	#9	#10
Head diameter (inch)		0.323	0.350	0.386
Minor thread diameter		0.106	0.122	0.136
Major thread diameter		0.165	0.183	0.211
Shaft diameter		0.122	0.136	0.154
Drive Size		TX20	TX20	TX20
Product Range		Approx Count per 1lb		
Length	Thread	#8	#9	#10
1"	3/4"	253		
1-1/4"	7/8"	214		
1-1/2"	1"	181		111
1-3/4"	1-1/8"	159		
2"	1-1/4"	146	112	85
2-1/2"	1-1/2"	118	92	70
2-3/4"	1-1/2"		83	
3"	1-1/2"		78	59
3-1/2"	2"			51
4"	2"			46
5"	2-1/2"			37
6"	2-1/2"			31

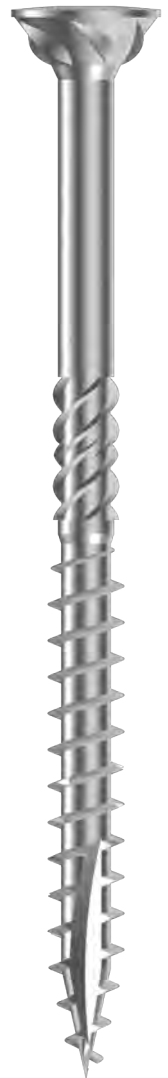

**WWW.SCREW-PRODUCTS.COM**  
9401 Bujacich Rd. Bldg 1B, Gig Harbor, WA 98332  
Toll-Free 1-877-844-8880

THE ULTIMATE FASTENERS

FOLLOW US  
  
#SCREWPRODUCTSINC

Weights and counts subject to change without notice.

Introducing  
**GEN II**



**THE  
ULTIMATE  
FASTENERS**

**EXTERIOR**

**STRUCTURAL**

**AXIS™**



**Horizon Curve™**

A slight curvature of the head for elegant, professional, architectural results. The Finish Ring underneath the head also provides a better finish by cutting the top fibers in the wood for an extra step in countersinking.



**Turbine Ribs™**

(patent pending) Turbine Ribs cut quickly into the wood, leaving a professional, clean finish with maximum wood contact. The cup shaped, countersinking head provides increased holding power and reduced risk of splitting.



**Twin Blades™**

(patent pending) This set of knurls cuts fast to dramatically reduce friction and heat on the shank, while reducing load on the drill. They also provide better performance by removing debris faster than a standard fastener's knurl.



**Fast Start Tip**

With sharp threads all the way to the tip, the fastener has an immediate grip for a fast start. The inset thread cut drastically reduces the splitting effect and minimizes the driving torque needed to engage the wood.

This advanced, General Purpose Structural Wood Screw with ZYTEC™ XT corrosion protection coating is for typical high-corrosive exterior and interior environments. Use them on any size job or project from framing to small wood working!



Available in 1lb, 5lb and 1/4 Keg  
All Packaging Includes Drive Bit!

**WWW.SCREW-PRODUCTS.COM**

9401 Bujacich Rd. Bldg 1B, Gig Harbor, WA 98332  
Toll-Free 1-877-844-8880

Weights and counts subject to change without notice.

**THE ULTIMATE FASTENERS**

6

FOLLOW US



#SCREWPRODUCTSINC

Nov 15, 2020



# THE ULTIMATE FASTENERS

## EXTERIOR

## STRUCTURAL

The AXIS™ Structural Wood Screw is the next step in fastener design. Every facet has been evaluated and improved (patents pending). Our extra sharp Fast Start Tip saves you time onsite and the Twin Blades outperform the competitor's knurls. The Turbine Ribbs ensure an incredibly clean finish. Its cup shaped, countersinking head, provides unparalleled holding power and less risk of splitting the wood. The Horizon Curve Head has been architecturally engineered to leave an elegant finish.



### TYPICAL EXTERIOR USE

**ZYTEC™ XT Coating:** For general outdoor use. Compatible with most above ground pressure treated lumber. For ground contact treated lumber, areas within one mile of saltwater, near swimming pools, exposure to corrosive chemicals, or other areas where corrosion is more like to occur, use proper grade **Stainless Steel**. Always follow timber manufacturer's recommendations for fasteners.

### Common Applications

- Commercial & residential
- General indoor and outdoor jobs
- Decking, railing and fencing
- Roofing and siding
- Construction, remodeling and repair
- Framing, windows and doors
- Trim & Cabinetry
- And much more!

### Sizes Available: #8 x 3/4" to #14 x 8"

General Info					
Type of Screw	General Purpose Structural Wood				
Material	Heat Treated, Hardened Steel				
Coating	ZYTEC™ XT				
Head Style	Countersinking TX20/30 Star Drive				
Point Type	Modified Type 17				
Construction	#8	#9	#10	#14	
Head diameter (inch)	.323	.350	.386	.488	
Minor thread diameter	.106	.122	.136	.152	
Major thread diameter	.165	.183	.211	.246	
Shaft diameter	.122	.136	.154	.173	
Drive Size	TX20	TX20	TX20	TX30	
Product Range		Approx Count per 1lb			
Length	Thread	#8	#9	#10	#14
3/4"	5/8"	326			
1"	3/4"	256	196		
1-1/4"	7/8"	219	164		
1-1/2"	1"	183	141		
1-3/4"	1-1/8"	162			
2"	1-1/4"	144	112	85	
2-1/2"	1-1/2"		90	69	
2-3/4"	1-1/2"		78		
3"	1-1/2"		78	59	
3-1/2"	2"			51	
4"	2"			45	
5"	2-1/2"			36	28
6"	2-1/2"			30	24
7"					20
8"					18



**WWW.SCREW-PRODUCTS.COM**  
9401 Bujacich Rd. Bldg 1B, Gig Harbor, WA 98332  
Toll-Free 1-877-844-8880

**THE ULTIMATE FASTENERS**

FOLLOW US  
  
#SCREWPRODUCTSINC

Weights and counts subject to change without notice.

Introducing  
**GEN II**



**THE  
ULTIMATE  
FASTENERS**

**STAINLESS STEEL**

**STRUCTURAL**

**AXIS™**

**STAINLESS STEEL**



**Horizon Curve™**

A slight curvature of the head for elegant, professional, architectural results. The Finish Ring underneath the head also provides a better finish by cutting the top fibers in the wood for an extra step in countersinking.



**Turbine Ribs™**

(patent pending) Turbine Ribs cut quickly into the wood, leaving a professional, clean finish with maximum wood contact. The cup shaped, countersinking head provides increased holding power and reduced risk of splitting.



**Twin Blades™**

(patent pending) This set of knurls cuts fast to dramatically reduce friction and heat on the shank, while reducing load on the drill. They also provide better performance by removing debris faster than a standard fastener's knurl.



**Fast Start Tip**

With sharp threads all the way to the tip, the fastener has an immediate grip for a fast start. The inset thread cut drastically reduces the splitting effect and minimizes the driving torque needed to engage the wood.

This advanced, General Purpose Structural Wood Screw is for typical very high-corrosive environments. Great for any size job or project such as decks, docks, boardwalks, fencing, railings, pools, hot tubs and more!



Available in 1lb, 5lb and 1/4 Keg  
All Packaging Includes Drive Bit!

**WWW.SCREW-PRODUCTS.COM**

9401 Bujacich Rd. Bldg 1B, Gig Harbor, WA 98332  
Toll-Free 1-877-844-8880

Weights and counts subject to change without notice.

**THE ULTIMATE FASTENERS**

8

FOLLOW US



#SCREWPRODUCTSINC

Nov 15, 2020



# THE ULTIMATE FASTENERS

## STAINLESS STEEL

## STRUCTURAL

The AXIS™ Structural Wood Screw is the next step in fastener design. Every facet has been evaluated and improved (patents pending). Our extra sharp Fast Start Tip saves you time onsite and the Twin Blades outperform the competitor's knurls. The Turbine Ribs ensure an incredibly clean finish. Its cup shaped, countersinking head, provides unparalleled holding power and less risk of splitting the wood. The Horizon Curve Head has been architecturally engineered to leave an elegant finish.

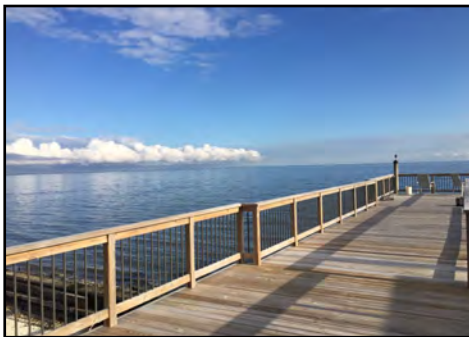
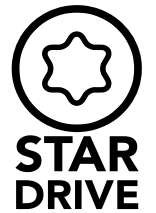

**Sizes Available: #8 x 1" to #10 x 4"**

General Info	
Type of Screw	General Purpose Structural Wood
Material	Stainless Steel <sup>1</sup> & 316 Stainless
Head Style	Countersinking TX20 Star Drive
Point Type	Modified Type 17
1. Our Gen II Products marked "Stainless Steel" are Austenitic Stainless Steel AISI 305 or better!	

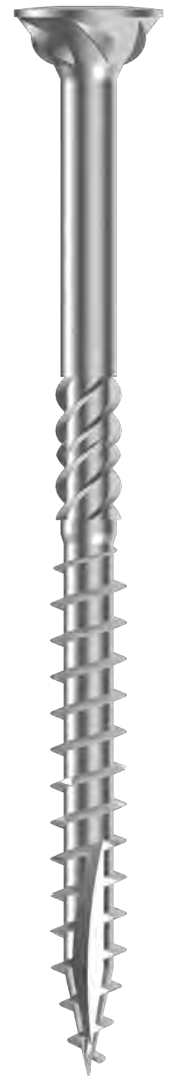

### TOUGH ENVIRONMENTS

**Stainless Steel:** Outdoor Coastal areas, surfaces with salt exposure, ground contact treated lumber, shipyards, medium polluted industrial areas, chemical plants, etc. Always follow timber manufacturer's recommendations for fasteners.

### Common Applications

- Commercial & residential
- Decking and railing
- Fencing
- Siding & roofing
- Remodeling and repair
- Framing
- Trim & Cabinetry
- Windows and doors
- Chlorinated areas
- Hot tubs & Swimming pools
- And much more!

Construction	#8	#9	#10
Head diameter (inch)	0.323	0.350	0.386
Minor thread diameter	0.106	0.122	0.136
Major thread diameter	0.165	0.183	0.211
Shaft diameter	0.122	0.136	0.154
Drive Size	TX20	TX20	TX20

Product Range		Approx Count per 1lb		
Length	Thread	#8	#9	#10
1"	Full Thread	252		
1-1/4"	7/8"	211		
1-1/2"	1"	178	146	
2"	1-1/4"	138	113	
2-1/2"	1-1/2"		87	70
3"	1-1/2"		76	60
3-1/2"	2"			51
4"	2"			46

Also Available in 316 Stainless Steel

**WWW.SCREW-PRODUCTS.COM**  
9401 Bujacich Rd. Bldg 1B, Gig Harbor, WA 98332  
Toll-Free 1-877-844-8880

**THE ULTIMATE FASTENERS**

FOLLOW US  
  
#SCREWPRODUCTSINC

Weights and counts subject to change without notice.

Introducing  
**GEN II**



**THE  
ULTIMATE  
FASTENERS**

**EXTERIOR**

**TRIM HEAD SCREW**

**EPIC™**

#### Advanced Trim Head

The Epic Trim Head is slightly larger in diameter than industry standards. This combined with the patent pending Turbine Ribs give maximum holding power while leaving a clean, professional finish.

#### Turbine Ribs™

(patent pending) Turbine Ribs cut quickly into the wood, leaving a professional, clean finish with maximum wood contact. The cup shaped, countersinking head provides increased holding power and reduced risk of splitting.

#### Twin Blades™

(patent pending) This set of knurls cuts fast to dramatically reduce friction and heat on the shank, while reducing load on the drill. They also provide better performance by removing debris faster than a standard fastener's knurl.

#### Fast Start Tip

With sharp threads all the way to the tip, the fastener has an immediate grip for a fast start. The inset thread cut drastically reduces the splitting effect and minimizes the driving torque needed to engage the wood.

This advanced, Trim Head Wood Screw with ZYTEC™ XT corrosion protection coating is for typical high-corrosive exterior and interior environments. Great for any size job or project.



Available in 1lb, 5lb and 1/4 Keg  
All Packaging Includes Drive Bit!

**WWW.SCREW-PRODUCTS.COM**

9401 Bujacich Rd. Bldg 1B, Gig Harbor, WA 98332  
Toll-Free 1-877-844-8880

Weights and counts subject to change without notice.

**THE ULTIMATE FASTENERS**

10

FOLLOW US



#SCREWPRODUCTSINC

Nov 15, 2020



# THE ULTIMATE FASTENERS

## EXTERIOR

## TRIM HEAD SCREW

The EPIC™ Trim Head Screw is designed to take wood screws to an entire new level (patent pending). Our extra sharp Fast Start Tip saves you time onsite and our Twin Blades outperform the competitor's knurls. The Turbine Ribs ensure an incredibly clean finish. Its cup shaped, countersinking head provides unparalleled holding power and less risk of splitting. The small trim head provides a clean, professional connection.



**Sizes Available: #9 x 1-5/8" to #9 x 5"**

General Info		
Type of Screw	Trim Head Wood Screw	
Material	Heat Treated, Hardened Steel	
Coating	ZYTEC™ XT	
Head Style	Countersinking TX20 Star Drive	
Point Type	Modified Type 17	
Construction		#9
Head diameter (inch)	0.260	
Minor thread diameter	0.122	
Major thread diameter	0.183	
Shaft diameter	0.136	
Drive Size	TX20	
Product Range		Approx Count per 11lb
Length	Thread	#9
1-5/8"	1"	148
2"	1-1/4"	122
2-1/2"	1-1/2"	98
3"	1-1/2"	82
4"	2"	61
5"	2-1/2"	50
Also Available with White Painted Head		



### TYPICAL EXTERIOR USE

**ZYTEC™ XT Coating:** For general outdoor use. Compatible with most above ground pressure treated lumber. For ground contact treated lumber, areas within one mile of saltwater, near swimming pools, exposure to corrosive chemicals, or other areas where corrosion is more like to occur, use proper grade **Stainless Steel**. Always follow timber manufacturer's recommendations for fasteners.

### Common Applications

- Commercial & residential
- General indoor and outdoor jobs
- Trim & Cabinetry
- Interior and exterior framing
- Windows and doors
- Remodeling and repair
- And Much more!

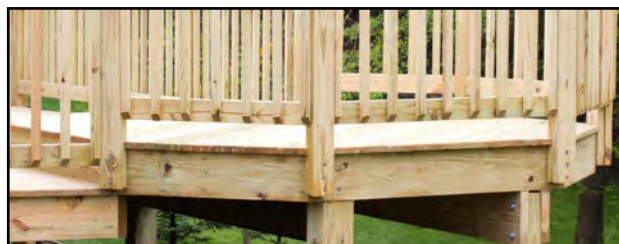

**WWW.SCREW-PRODUCTS.COM**  
9401 Bujacich Rd. Bldg 1B, Gig Harbor, WA 98332  
Toll-Free 1-877-844-8880

**THE ULTIMATE FASTENERS**

FOLLOW US  
  
#SCREWPRODUCTSINC

Weights and counts subject to change without notice.

Introducing  
**GEN II**



**THE  
ULTIMATE  
FASTENERS**

**STAINLESS STEEL**

**TRIM HEAD SCREW**

**EPIC™**

**STAINLESS STEEL**



**Advanced Trim Head**

The Epic Trim Head is slightly larger in diameter than industry standards. This combined with the patent pending Turbine Ribs give maximum holding power while leaving a clean, professional finish.



**Turbine Ribs™**

(patent pending) Turbine Ribs cut quickly into the wood, leaving a professional, clean finish with maximum wood contact. The cup shaped, countersinking head provides increased holding power and reduced risk of splitting.



**Twin Blades™**

(patent pending) This set of knurls cuts fast to dramatically reduce friction and heat on the shank, while reducing load on the drill. They also provide better performance by removing debris faster than a standard fastener's knurl.



**Fast Start Tip**

With sharp threads all the way to the tip, the fastener has an immediate grip for a fast start. The inset thread cut drastically reduces the splitting effect and minimizes the driving torque needed to engage the wood.

This advanced, Trim Head Wood Screw for typical very high-corrosive environments. Use them on any size job or project. Great for decks, docks, fencing and railings!



Available in 1lb, 5lb and 1/4 Keg  
All Packaging Includes Drive Bit!

**WWW.SCREW-PRODUCTS.COM**  
9401 Bujacich Rd. Bldg 1B, Gig Harbor, WA 98332  
Toll-Free 1-877-844-8880

Weights and counts subject to change without notice.

**THE ULTIMATE FASTENERS**

FOLLOW US  
  
#SCREWPRODUCTSINC



THE ULTIMATE FASTENERS

STAINLESS STEEL

TRIM HEAD SCREW

The EPIC™ Trim Head Screw is designed to take wood screws to an entire new level (patent pending). Our extra sharp Fast Start Tip saves you time onsite and our Twin Blades outperform the competitor's knurls. The Turbine Ribs ensure an incredibly clean finish. Its cup shaped, countersinking head provides unparalleled holding power and less risk of splitting. The small trim head provides a clean, professional connection.

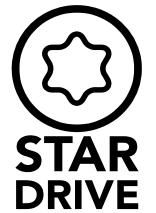

Sizes Available: #9 x 1-5/8" to #9 x 4"



TOUGH ENVIRONMENTS

Stainless Steel: Outdoor Coastal areas, surfaces with salt exposure, ground contact treated lumber, shipyards, medium polluted industrial areas, chemical plants, etc. Always follow timber manufacturer's recommendations for fasteners.

Common Applications

- Commercial & residential
• General indoor and outdoor jobs
• Trim & Cabinetry
• Interior and exterior framing
• Windows and doors
• Remodeling and repair
• Chlorinated areas
• Hot tubs
• Swimming pools
• And Much more!

Table with General Info, Construction, and Product Range sections. Includes details like Type of Screw, Material, Head Style, Point Type, and a table for Product Range with Length, Thread, and Approx Count per 1lb.

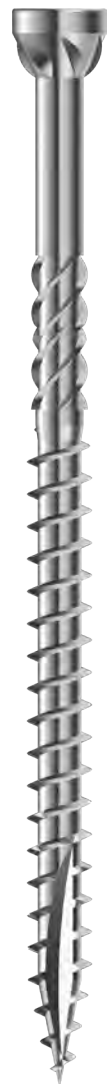

Introducing  
**GEN II**



**THE  
ULTIMATE  
FASTENERS**

**EXTERIOR**

**FINISH HEAD SCREW**

**PICO™**

#### **Tiny Finish Head**

The tiny finishwork head has been specifically engineered to be almost invisible when installed without compromising strength of the head or screw. The head size fits with concealed mounting tools.

#### **Reverse Threads**

The reverse threads helps to pull down debris and works perfectly together with the small head size to create a clean finish.

#### **Fast Start Tip**

With sharp threads all the way to the tip, the fastener has an immediate grip for a fast start. The inset thread cut drastically reduces the splitting effect and minimizes the driving torque needed to engage the wood.

#### **Also For Concealed Fastening**

For jobs where concealing the fastener is important, we have engineered these screws to fit most concealed fastening tools.

This advanced, Finish Head Wood Screw with ZYTEC™ GX corrosion protection coating is for typical high-corrosive exterior and interior environments. Great for any size job or project.



Available in 1lb, 5lb and 1/4 Keg  
All Packaging Includes Drive Bit!

**WWW.SCREW-PRODUCTS.COM**

9401 Bujacich Rd. Bldg 1B, Gig Harbor, WA 98332  
Toll-Free 1-877-844-8880

Weights and counts subject to change without notice.

**THE ULTIMATE FASTENERS**

14

FOLLOW US



#SCREWPRODUCTSINC

Nov 15, 2020



# THE ULTIMATE FASTENERS

## EXTERIOR

## FINISH HEAD SCREW

The PICO™ Finish Screw is a slim fastener, yet engineered for good holding power. Our extra sharp Fast Start Tip grips quickly into the wood and saves you time on site. The wide threads provides a strong connection while the reverse threads helps pull down fibers. The tiny head stays out of sight for a clean, professional finish. Fits with most concealed mounting tools.



**Sizes Available: #8 x 1-5/8" to #8 x 3**

General Info		
Type of Screw	Finish Head Wood Screw	
Material	Heat Treated, Hardened Steel	
Coating	ZYTEC™ GX	
Head Style	Countersinking TX15 Star Drive	
Point Type	Modified Type 17	
Construction		#8
Head diameter (inch)	0.201	
Minor thread diameter	0.106	
Major thread diameter	0.165	
Shaft diameter	0.122	
Drive Size	TX15	
Product Range		Approx Count per 1lb
Length	Thread	#8
1-5/8"	1"	206
2"	1-1/4"	164
2-1/2"	1-1/2"	130
3"	1-1/2"	109
Also Available with White Painted Head		



### TYPICAL EXTERIOR USE

**ZYTEC™ GX Coating:** For general outdoor use. Compatible with most above ground pressure treated lumber. For ground contact treated lumber, areas within one mile of saltwater, near swimming pools, exposure to corrosive chemicals, or other areas where corrosion is more like to occur, use proper grade **Stainless Steel**. Always follow timber manufacturer's recommendations for fasteners.

### Common Applications

- Commercial & residential
- Finish & trim work
- Hidden decking
- Interior and exterior framing
- Windows and doors
- Remodeling and repair
- Cabinetry
- And Much more!



**WWW.SCREW-PRODUCTS.COM**  
9401 Bujacich Rd. Bldg 1B, Gig Harbor, WA 98332  
Toll-Free 1-877-844-8880

**THE ULTIMATE FASTENERS**

FOLLOW US  
  
#SCREWPRODUCTSINC

Weights and counts subject to change without notice.

Introducing  
**GEN II**



**THE  
ULTIMATE  
FASTENERS**

**STAINLESS STEEL**

**FINISH HEAD SCREW**

**PICO™**

**STAINLESS STEEL**



**Tiny Finish Head**

The tiny finishwork head has been specifically engineered to be almost invisible when mounted without compromising strength of the head or screw. The head size fits with concealed mounting tools.



**Reverse Threads**

The reverse threads helps to pull down debris and works perfectly together with the small head size to create a clean finish.



**Fast Start Tip**

With sharp threads all the way to the tip, the fastener has an immediate grip for a fast start. The inset thread cut drastically reduces the splitting effect and minimizes the driving torque needed to engage the wood.



**Also For Concealed Fastening**

For jobs where concealing the fastener is important, we have engineered these screws to fit most concealed fastening tools.

This advanced, Finish Head Wood Screw is for typical very high-corrosive environments. Great for any size job or project.



Available in 1lb, 5lb and 1/4 Keg  
All Packaging Includes Drive Bit!

**WWW.SCREW-PRODUCTS.COM**  
9401 Bujacich Rd. Bldg 1B, Gig Harbor, WA 98332  
Toll-Free 1-877-844-8880

Weights and counts subject to change without notice.

**THE ULTIMATE FASTENERS**

FOLLOW US  
  
#SCREWPRODUCTSINC



# THE ULTIMATE FASTENERS

## STAINLESS STEEL

## FINISH HEAD SCREW

The PICO™ Finish Screw is a slim fastener, yet engineered for good holding power. Our extra sharp Fast Start Tip grips quickly into the wood and saves you time on site. The wide threads provides a strong connection while the reverse threads helps pull down fibers. The tiny head stays out of sight for a clean, professional finish. Fits with most concealed mounting tools.



**Sizes Available: #8 x 1-5/8" to #8 x 3**



### TOUGH ENVIRONMENTS

**Stainless Steel:** Outdoor Coastal areas, surfaces with salt exposure, ground contact treated lumber, shipyards, medium polluted industrial areas, chemical plants, etc. Always follow timber manufacturer's recommendations for fasteners.

### Common Applications

- Commercial & residential
- For tough environments
- Finish & trim work
- Hidden decking
- Interior and exterior framing
- Windows and doors
- Remodeling and repair
- Cabinetry
- Chlorinated areas
- Swimming pools & Hot Tubs
- And Much more!

General Info		
Type of Screw	Finish Head Wood Screw	
Material	Stainless Steel <sup>1</sup> & 316 Stainless	
Head Style	Countersinking TX15 Star Drive	
Point Type	Modified Type 17	
1. Our Gen II Products marked "Stainless Steel" are Austenitic Stainless Steel AISI 305 or better!		
Construction		#8
Head diameter (inch)	0.201	
Minor thread diameter	0.106	
Major thread diameter	0.165	
Shaft diameter	0.122	
Drive Size	TX15	
Product Range		Approx Count per 1lb
Length	Thread	#8
1-5/8"	1"	187
2"	1-1/4"	158
2-1/2"	1-1/2"	119
3"	1-1/2"	104
Also Available in 316 Stainless Steel		



**WWW.SCREW-PRODUCTS.COM**  
9401 Bujacich Rd. Bldg 1B, Gig Harbor, WA 98332  
Toll-Free 1-877-844-8880

**THE ULTIMATE FASTENERS**

FOLLOW US  
  
#SCREWPRODUCTSINC

Weights and counts subject to change without notice.

Introducing  
**GEN II**



**THE  
ULTIMATE  
FASTENERS**

**INTERIOR/EXTERIOR**

**CABINETS & MORE**

**AURA™**



**Aesthetic Design Mushroom Head**

The aesthetic head design is shaped to compliment a clean finish in cabinetry, furniture, and more. The head is bold to show its architectural shape and decorates visible surfaces.



**Graduated Shoulder**

The bigger head increases holding power on the wood, while the graduated shoulder from head to shank ensures maximum strength for the fastener head.



**Fast Start Tip**

With sharp threads all the way to the tip, the fastener has an immediate grip for a fast start. The inset thread cut drastically reduces the splitting effect and minimizes the driving torque needed to engage the wood.



**Excellent For Joinery Tools**

Size #8 head has been designed to fit perfectly with most pocket joinery tools on the market. Excellent for cabinetry and more! Kreg Jig® compatible.

This advanced, Cabinetry (& more!) Wood Screw with ZYTEC™ GX corrosion protection coating is for typical high-corrosive exterior and interior environments. Great for any size job or project.



Available in 1lb, 5lb and 1/4 Keg  
All Packaging Includes Drive Bit!

**WWW.SCREW-PRODUCTS.COM**

9401 Bujacich Rd. Bldg 1B, Gig Harbor, WA 98332  
Toll-Free 1-877-844-8880

Weights and counts subject to change without notice.

**THE ULTIMATE FASTENERS**

18

FOLLOW US



#SCREWPRODUCTSINC

Nov 15, 2020



# THE ULTIMATE FASTENERS

## INTERIOR/EXTERIOR

## CABINETS & MORE

The AURA™ screw features an aesthetic design of the mushroom head shaped to fit in cabinetry, furniture and more. The large diameter head of the fastener ensures increased holding power. The head size on the #8 version has been designed to fit most pocket joinery tools on the market. Our extra sharp Fast Start Tip allows the screw to grip quickly into the wood providing easy installation.

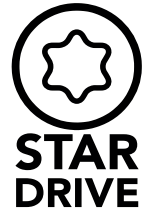

**Sizes Available: #8 x 1" to #10 x 3"**

General Info			
Type of Screw	General Purpose Wood		
Material	Heat Treated, Hardened Steel		
Coating	ZYTEC™ GX		
Head Style	Mushroom TX20 Star Drive		
Point Type	Modified Type 17		
Construction		#8	#10
Head diameter (inch)		0.362	0.476
Minor thread diameter		0.106	0.136
Major thread diameter		0.165	0.211
Shaft diameter		0.122	0.154
Drive Size		TX20	TX20
Product Range		Approx Count per 1lb	
Length	Thread	#8	#10
1"	3/4"	215	126
1-1/4"	7/8"	187	108
1-1/2"	1"	161	94
2"	1-1/4"	131	77
2-1/2"	1-1/2"	108	63
3"	1-1/2"		54
Also Available with White Painted Head			

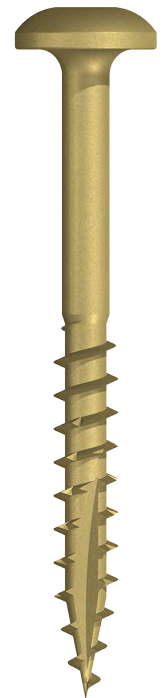

### TYPICAL EXTERIOR USE

**ZYTEC™ GX Coating:** For general outdoor use. Compatible with most above ground pressure treated lumber. For ground contact treated lumber, areas within one mile of saltwater, near swimming pools, exposure to corrosive chemicals, or other areas where corrosion is more like to occur, use proper grade **Stainless Steel**. Always follow timber manufacturer's recommendations for fasteners.

### Common Applications

- Commercial & residential
- General indoor and outdoor jobs
- Cabinetry
- #8 version is great for pocket joinery
- Vinyl & aluminum screens and doors
- Furniture manufacturing
- And Much more!



**WWW.SCREW-PRODUCTS.COM**  
9401 Bujacich Rd. Bldg 1B, Gig Harbor, WA 98332  
Toll-Free 1-877-844-8880

**THE ULTIMATE FASTENERS**

FOLLOW US  
  
#SCREWPRODUCTSINC

Weights and counts subject to change without notice.

Introducing  
**GEN II**



**THE  
ULTIMATE  
FASTENERS**

**EXTERIOR**

**STRUCTURAL LAG**

# NOVA™



### Horizon Curve™

A slight curvature of the head for elegant, professional, architectural results. Whether countersinking or surface mounting, the results are impressive!



### Locking Wedges

The locking wedges help to mill and countersink the head into the wood for a clean finish. It also locks the head into place preventing unwanted future movement.



### Twin Blades™

(patent pending) This set of knurls cuts fast to dramatically reduce friction and heat on the shank, while reducing load on the drill. They also provide better performance by removing debris faster than a standard fastener's knurl.



### Fast Start Tip

With sharp threads all the way to the tip, the fastener has an immediate grip for a fast start. The inset thread cut drastically reduces the splitting effect and minimizes the driving torque needed to engage the wood.

The advanced, Heavy Duty Structural Lag Screw with **ZYTEC™ GX** corrosion protection coating is for typical high-corrosive, exterior, and interior environments. Great for any size job or project.



Available in 50ct, 100ct & 1/4 Keg  
All Packaging Includes Drive Bit!

[WWW.SCREW-PRODUCTS.COM](http://WWW.SCREW-PRODUCTS.COM)

9401 Bujacich Rd. Bldg 1B, Gig Harbor, WA 98332  
Toll-Free 1-877-844-8880

Weights and counts subject to change without notice.

**THE ULTIMATE FASTENERS**

20

FOLLOW US



#SCREWPRODUCTSINC

Nov 15, 2020



# THE ULTIMATE FASTENERS

## EXTERIOR

## STRUCTURAL LAG

The new NOVA™ Structural Lag is the superior lag screw for any of your projects. With a strong thread that ensures maximum withdrawal strength and extra sharp Fast Start Tip that easily grips and cuts its way through the wood, you will feel the power and quality of the NOVA. The Twin Blades ensures minimum friction on the shank and the Locking Wedges under the head countersink perfectly with maximum wood contact.



### TYPICAL EXTERIOR USE

**ZYTEC™ GX Coating:** For general outdoor use. Compatible with most above ground pressure treated lumber. For ground contact treated lumber, areas within one mile of saltwater, near swimming pools, exposure to corrosive chemicals, or other areas where corrosion is more like to occur, use proper grade **Stainless Steel**. Always follow timber manufacturer's recommendations for fasteners.

### Common Applications

- Commercial & residential
- Timber
- Ledgers, posts & beams
- LVL (Laminated Veneer Lumber)
- SIP (Structural Insulated Panels)
- Rigid Foam Insulation
- Roofing
- Deck framing
- Docks
- And much more!

### Sizes Available: #14 x 1" to #18 x 16"

General Info			
Type of Screw	General Purpose Wood		
Material	Heat Treated, Hardened Steel		
Coating	ZYTEC™ GX		
Head Style	Low Profile TX30/40 Star Drive		
Point Type	Modified Type 17		
Construction	#14	#16	#18
Head diameter (inch)	0.531"	0.630"	0.728"
Minor thread diameter	0.152"	0.177"	0.205"
Major thread diameter	0.246"	0.283"	0.315"
Shaft diameter	0.173"	0.205"	0.226"
Drive Size	TX30	TX30	TX40
Product Range	Thread Length		
Length	#14	#16	#18
1"	3/4"		
1-1/2"	1"		
2"	1-1/2"	1-1/2"	
2-1/2"	1-1/2"	1-1/2"	
3"	1-1/2"	1-1/2"	
3-3/8"			1-1/2"
3-1/2"		1-1/2"	
4"	2"	2"	2"
4-1/2"		2"	
5"	3"	3"	1-1/2"
6"	3"	3"	3"
6-3/4"			1-1/2"
7"			3-1/2"
8"			4"
10"			4"
12"			5"
14"			6"
16"			6"



Introducing  
**GEN II**



THE  
**ULTIMATE  
FASTENERS**

**#16x 5/16" HEX HEAD**

**STRUCTURAL LAG**

**YUKON™**



**Small Washer Hex Head**

Strong Structural Lag screw with 5/16" Hex Head for a powerful torque transmission and easy installation. The built-in washer underneath the head provides great holding power and works well for heavy duty applications.



**Twin Blades™**

(patent pending) This set of knurls cuts fast to dramatically reduce friction and heat on the shank, while reducing load on the drill. They also provide better performance by removing debris faster than a standard fastener's knurl.



**Fast Start Tip**

With sharp threads all the way to the tip, the fastener has an immediate grip for a fast start. The inset thread cut drastically reduces the splitting effect and minimizes the driving torque needed to engage the wood.

The advanced, Heavy Duty Structural Lag Screw with **ZYTEC™ GX** corrosion protection coating for typical typical high-corrosive, exterior, and interior environments. Great for any size job or project.



Available in 50ct and 250ct.  
All Packaging Includes Hex Driver.

**WWW.SCREW-PRODUCTS.COM**

9401 Bujacich Rd. Bldg 1B, Gig Harbor, WA 98332  
Toll-Free 1-877-844-8880

Weights and counts subject to change without notice.

**THE ULTIMATE FASTENERS**

22

FOLLOW US



#SCREWPRODUCTSINC

Nov 15, 2020



# THE ULTIMATE FASTENERS

## #16x 5/16" HEX HEAD

## STRUCTURAL LAG



### TYPICAL EXTERIOR USE

**ZYTEC™ GX Coating:** For general outdoor use. Compatible with most above ground pressure treated lumber. For ground contact treated lumber, areas within one mile of saltwater, near swimming pools, exposure to corrosive chemicals, or other areas where corrosion is more like to occur, use proper grade **Stainless Steel**. Always follow timber manufacturer's recommendations for fasteners.

### Common Applications

- Commercial & residential
- Landscaping
- Heavy duty lumber
- LVL (Laminated Veneer Lumber)
- Deck framing
- Trusses
- Ledgers
- Posts
- Beams
- And Much more!

Sizes Available: #16 x 4" to #16 x 14"

General Info	
Type of Screw	Hex Head Structural Wood Screw
Material	Heat Treated, Hardened Steel
Coating	ZYTEC™ GX
Head Style	5/16" Hex Head
Point Type	Modified Type 17
Construction #16	
Head diameter (inch)	0.472"
Minor thread diameter	0.177"
Major thread diameter	0.283"
Shaft diameter	0.205"
Drive Size	5/16" HEX
Product Range #16	
Length	Thread
4"	2"
6"	2"
8"	2"
10"	2"
12"	2"
14"	2"



**WWW.SCREW-PRODUCTS.COM**  
9401 Bujacich Rd. Bldg 1B, Gig Harbor, WA 98332  
Toll-Free 1-877-844-8880

Weights and counts subject to change without notice.

**THE ULTIMATE FASTENERS**

FOLLOW US  
  
#SCREWPRODUCTSINC

Introducing  
**GEN II**



THE  
**ULTIMATE  
FASTENERS**

#18x 5/16" HEX HEAD

STRUCTURAL LAG

**YUKON™**



#### Large Washer Hex Head

Strong Structural Lag screw with 5/16" Hex Head for a powerful torque transmission and easy installation. The built-in washer underneath the head provides great holding power and works well for heavy duty applications.



#### Twin Blades™

(patent pending) This set of knurls cuts fast to dramatically reduce friction and heat on the shank, while reducing load on the drill. They also provide better performance by removing debris faster than a standard fastener's knurl.



#### Fast Start Tip

With sharp threads all the way to the tip, the fastener has an immediate grip for a fast start. The inset thread cut drastically reduces the splitting effect and minimizes the driving torque needed to engage the wood.

The advanced, Heavy Duty Structural Lag Screw with **ZYTEC™ GX** corrosion protection coating for typical typical high-corrosive, exterior, and interior environments. Great for any size job or project.



Available in 50ct and 250ct.  
All Packaging Includes Hex Driver.

[WWW.SCREW-PRODUCTS.COM](http://WWW.SCREW-PRODUCTS.COM)

9401 Bujacich Rd. Bldg 1B, Gig Harbor, WA 98332  
Toll-Free 1-877-844-8880

Weights and counts subject to change without notice.

THE ULTIMATE FASTENERS

24

FOLLOW US



#SCREWPRODUCTSINC

Nov 15, 2020



THE ULTIMATE FASTENERS

#18x 5/16" HEX HEAD

STRUCTURAL LAG



### TYPICAL EXTERIOR USE

**ZYTEC™ GX Coating:** For general outdoor use. Compatible with most above ground pressure treated lumber. For ground contact treated lumber, areas within one mile of saltwater, near swimming pools, exposure to corrosive chemicals, or other areas where corrosion is more like to occur, use proper grade **Stainless Steel**. Always follow timber manufacturer's recommendations for fasteners.

### Common Applications

- Commercial & residential
- Landscaping Timbers
- Heavy duty lumber
- LVL (Laminated Veneer Lumber)
- Deck framing
- Ledgers
- Posts
- Beams
- And Much more!

Sizes Available: #18 x 4" to #18 x 11"

General Info	
Type of Screw	Hex Head Structural Wood Screw
Material	Heat Treated, Hardened Steel
Coating	ZYTEC™ GX
Head Style	5/16" Hex Head
Point Type	Modified Type 17
Construction #18	
Head diameter (inch)	0.630"
Minor thread diameter	0.205"
Major thread diameter	0.315"
Shaft diameter	0.226"
Drive Size	5/16" HEX
Product Range #18	
Length	Thread
4"	2"
5"	2-3/4"
6"	2-3/4"
7"	2-3/4"
9"	2-3/4"
11"	2-3/4"



WWW.SCREW-PRODUCTS.COM  
9401 Bujacich Rd. Bldg 1B, Gig Harbor, WA 98332  
Toll-Free 1-877-844-8880

Weights and counts subject to change without notice.

THE ULTIMATE FASTENERS

FOLLOW US  
#SCREWPRODUCTSINC

Introducing  
**GEN II**



**THE  
ULTIMATE  
FASTENERS**

**EXTERIOR**

**WOOD TO STEEL**

**ROCO**<sup>TM</sup>

#### Horizon Curve<sup>TM</sup>

A slight curvature of the head for elegant, professional, architectural results. The Finish Ring underneath the head also provides a better finish by cutting the top fibers in the wood for an extra step in countersinking.

#### Turbine Ribs<sup>TM</sup>

(patent pending) Turbine Ribs cut quickly into the wood, leaving a professional, clean finish with maximum wood contact. The cup shaped, countersinking head provides increased holding power and reduced risk of splitting.

#### Unique Wing Design

The unique wing design is engineered to mill an oversize hole in the wood without breaking. As soon as the wings reach the steel, they easily break off, allowing the threads to tap into the steel base.

#### Superior Drill Point

The drill point has been specifically engineered to penetrate the steel as fast as possible. The angle and shape of the point makes it possible to remove steel chips fast and efficiently to enhance penetration.

This advanced, Wood to Steel Screw with **ZYTEC<sup>TM</sup> GX** corrosion protection coating is for typical high-corrosive, exterior, and interior environments. Great for any size job or project.



Available in 1lb, 5lb and 1/4 Keg  
All Packaging Includes Drive Bit!

**WWW.SCREW-PRODUCTS.COM**

9401 Bujacich Rd. Bldg 1B, Gig Harbor, WA 98332  
Toll-Free 1-877-844-8880

Weights and counts subject to change without notice.

**THE ULTIMATE FASTENERS**

26

FOLLOW US



#SCREWPRODUCTSINC

Nov 15, 2020



# THE ULTIMATE FASTENERS

## EXTERIOR

## WOOD TO STEEL

The ROCO™ Wood to Steel screw is specifically designed for increased holding power and an incredibly clean finish. When engaging the wood, the screw effortlessly drills through the wood while the wings mill an oversized hole. When the screw engages the steel base, the oversized hole prevents threads from engaging the wood, lifting wood and steel apart (jacking). The specially engineered drill point cuts fast through the steel and the threads firmly clamp the wood and steel together.

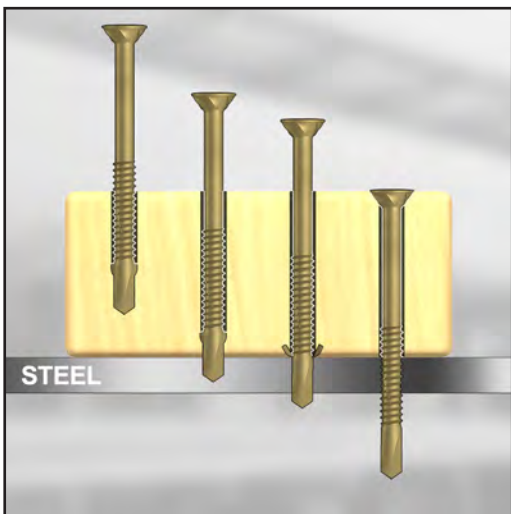

### TYPICAL EXTERIOR USE

**ZYTEC™ GX Coating:** For general outdoor use. Compatible with most above ground pressure treated lumber. For ground contact treated lumber, areas within one mile of saltwater, near swimming pools, exposure to corrosive chemicals, or other areas where corrosion is more likely to occur, use proper grade **Stainless Steel**.

### Common Applications

- Commercial & residential
- Wood to steel
- Truck & Trailer beds
- Wood rails on steel posts
- And Much more!

### Sizes Available: #10 x 1-1/2" to #14 x 3-3/4"

General Info				
Type of Screw	Wood to Steel			
Material	Heat Treated, Hardened Steel			
Coating	ZYTEC™ GX			
Head Style	Countersinking TX20/30 Star Drive			
Point Type	Drill Point			
Construction		#10	#12	#14
Head diameter		0.350"	0.386"	0.488"
Minor thread diameter		0.138"	0.161"	0.192"
Major thread diameter		0.186"	0.212"	0.246"
Shaft diameter	Full Thread	0.173"	0.203"	
Drive Size		TX20	TX20	TX30
Product Range		Approx Count per 1lb		
Length	Drill Point	#10	#12	#14
10 x 1-1/2"	#3	130		
12 x 2"	#3		74	
12 x 2-1/2"	#3		57	
14 x 2-3/4"	#4			38
14 x 3-3/4"	#4			28
		Drill Capacity		Wood Thickness
#10 Drill Point #3		Min	Max	Max
10 X 1-1/2"		0.059"	0.217"	0.87"
		#12 Drill Point #3		
12 X 2"		0.059"	0.236"	1.30"
12 X 2-1/2"		0.059"	0.236"	1.89"
		#14 Drill Point #4		
14 X 2-3/4"		0.138"	0.315"	1.89"
14 X 3-3/4"		0.138"	0.315"	2.87"

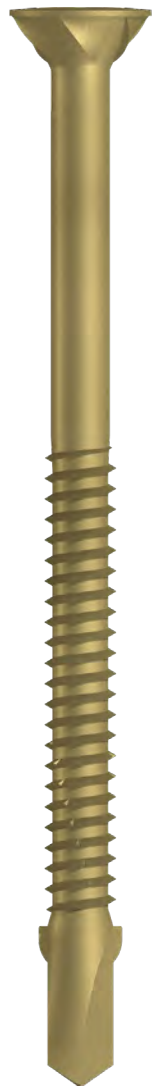

[WWW.SCREW-PRODUCTS.COM](http://WWW.SCREW-PRODUCTS.COM)

9401 Bujacich Rd. Bldg 1B, Gig Harbor, WA 98332  
Toll-Free 1-877-844-8880

Weights and counts subject to change without notice.

THE ULTIMATE FASTENERS

FOLLOW US



#SCREWPRODUCTSINC



# THE ULTIMATE FASTENERS

EXTERIOR & 305 SS

COMPOSITE DECK

# C-DECK



*Includes Drive Bit!*

*.26" Head Diameter*

**TREX® Approved!**

**The Ultimate Composite Deck Screw! Available in ACQ Compatible Coated and 305 Stainless Steel.** For use with wood, composite, PVC and other plastic materials. Our e-coat screws are available in 23 colors that will match most common deck colors on the market and has shown over 1000 hours of resistance in salt spray tests! Our C-deck is specially designed to eliminate the mushrooming that can occur in composite materials.

Coverage Chart	Decking	16" centers
1750 ct	5 ½"	500 sq ft
350 ct	5 ½"	100 sq ft
75ct	5 ½"	20 sq ft

## Coated Steel

## 305 Stainless Steel

Item Number	Net Wt*	Drive Size	Item Number	Drive Size	Net Wt*		
Unpainted			Unpainted				
Cedar	CD234TTC	19.3 lbs	TX20	SSCD234	TX20	22.3 lbs	
Desert Bronze	CD234DB	19.3 lbs	TX20	Cedar	SSCD234TTC	TX20	22.2 lbs
Fire Pit	CD234FP	19.3 lbs	TX20	Desert Bronze	SSCD234DB	TX20	22.2 lbs
Flint	CD234FT	19.3 lbs	TX20	Fire Pit	SSCD234FP	TX20	22.2 lbs
Gravel Path	CD234GP	19.3 lbs	TX20	Flint	SSCD234FT	TX20	22.2 lbs
Madeira	CD234M	19.3 lbs	TX20	Gravel Path	SSCD234GP	TX20	22.2 lbs
Rope Swing	CD234RS	19.3 lbs	TX20	Madeira	SSCD234TTG	TX20	22.2 lbs
Saddle	CD234S	19.3 lbs	TX20	Gray	SSCD234M	TX20	22.2 lbs
Sandridge	CD234SR	19.3 lbs	TX20	Rope Swing	SSCD234RS	TX20	22.2 lbs
Teak	CD234TK	19.3 lbs	TX20	Saddle	SSCD234S	TX20	22.2 lbs
Tree House	CD234TH	19.3 lbs	TX20	Sandridge	SSCD234SR	TX20	22.2 lbs
Vintage Lantern	CD234VL	19.3 lbs	TX20	Teak	SSCD234TK	TX20	22.2 lbs
Winchester Grey	CD234WG	19.3 lbs	TX20	Tree House	SSCD234TH	TX20	22.2 lbs
Woodland Brown	CD234WB	19.3 lbs	TX20	Vintage Lantern	SSCD234VL	TX20	22.2 lbs
Walnut	CD234WN	19.3 lbs	TX20	Winchester Grey	SSCD234WG	TX20	22.2 lbs
Gray	CD234TTG	19.3 lbs	TX20	Woodland Brown	SSCD234WB	TX20	22.2 lbs
Mountain Cedar	CD234MC	19.3 lbs	TX20	Walnut	SSCD234WN	TX20	22.2 lbs
Pebble Grey	CD234PG	19.3 lbs	TX20				
Redwood	CD234RW	19.3 lbs	TX20				
River Rock	CD234RR	19.3 lbs	TX20				
Rosewood	CD234ROW	19.3 lbs	TX20				
Rustic Bark	CD234RB	19.3 lbs	TX20				
White	CD234WH	19.3 lbs	TX20				

**WWW.SCREW-PRODUCTS.COM**

9401 Bujacich Rd. Bldg 1B, Gig Harbor, WA 98332  
Toll-Free 1-877-844-8880

Weights and counts subject to change without notice.

**THE ULTIMATE FASTENERS**

FOLLOW US



#SCREWPRODUCTSINC

## DeckLok® Advanced Lateral Anchor System

DeckLok® – The Original Lateral Anchor System – is revolutionizing the decking industry. The patented DeckLok system will provide a bolted connection at all critical structural locations of your deck. A single pair of DeckLok brackets will provide 4000 lbs of pull out resistance. DeckLok will also increase rail post connections by up to 500%. Great for the deck-to-ledger connection, stair stringer, rail post and more. You NEED DeckLok to meet code! See [screw-products.com](http://screw-products.com) for instructions and video.

Item Number	Description	Net Wt
DL316SS	316 Stainless Steel Lateral Anchor	0.9 lbs
DLHDG	Hot Dip Galvanized Lateral Anchor	0.9 lbs

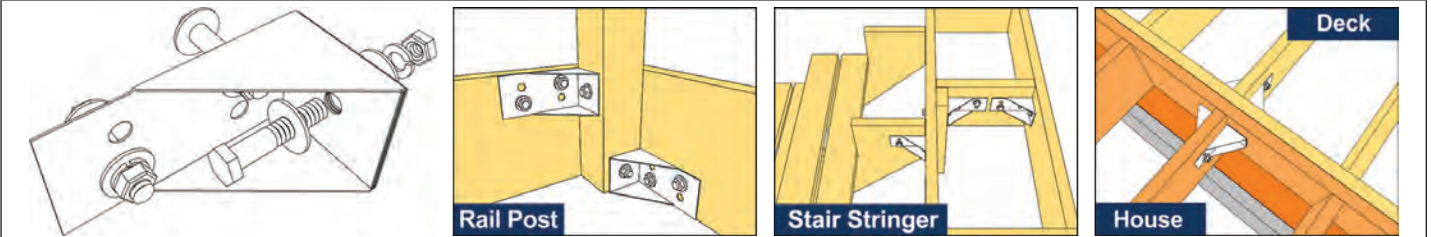

- For use with lumber or engineered flooring systems.
- Use with standard 1/2" hot-dipped galvanized or SS bolts.
- Code compliant hot-dipped galvanized or 316 stainless steel.
- Easy to install on existing structures or new construction
- One pair of DeckLok lateral anchors provides up to 4,000 lbs. of pullout resistance.
- DeckLok® is one of the most cost effective ways to consistently build a safe and secure deck and guardrail system.

**Made In The USA!**



## RailLok® Railing & Fence Section Connection

RailLok® is used to connect railing and fence sections to the rail post. Attach the brackets to the rail post using included screws and then slip pre-assembled railing or fence sections into the brackets and screw them in place. The RailLok brackets provide a strong, reliable fence section to post connection. The brackets are built to outlast the service life of the railing and fence sections.

Item Number	Description	Net Wt
RLBLK (also available in 4 Packs)	Black RailLok Bracket (Includes 5 Star Drive Screws)	0.2 lbs
RLWHT (also available in 4 Packs)	White RailLok Bracket (Includes 5 Star Drive Screws)	0.2 lbs
RL316SS (also available in 4 Packs)	316 Stainless RailLok Bracket (Includes 5 Star Drive Screws)	0.2 lbs



**Made In The USA!**

**WWW.SCREW-PRODUCTS.COM**

9401 Bujacich Rd. Bldg 1B, Gig Harbor, WA 98332  
Toll-Free 1-877-844-8880

Weights and counts subject to change without notice.

**THE ULTIMATE FASTENERS**

## The Ultimate Hidden Deck Fastener



The Ultimate Hidden Deck Fastener All-In-One System! Marine grade aluminum clip and paired with included black coated 305 Stainless Steel Star Drive screws. Our clip requires no drilling. The aluminum clip holds decks more effectively than plastic clips and it's literally out of sight!



- ★ Holds deck more effectively than plastic clips
- ★ Black marine grade aluminum clip
- ★ Includes black stainless steel star drive screws
- ★ No drilling. No glue. No hassle.
- ★ Excellent for Rain Screens



**Each unit contains:**

- (175) Clips
- (175) 2-1/4" Star Drive Screws
- (10) 2-1/4" starter & finisher screws
- Hard Wood Plugs
- (1) TX20x2 Drive Bit
- Instructions

When using 5-1/2" wide decking, each jar will install 100 square feet of decking on 16" centers, or 150 square feet on 24" centers.

Item Number	Description	Net Wt	Package
DC175	Deck Clip System	3.3 lbs	1 Pack
DCPlugs	Package of 50ct Hole Plugs	.1 lbs	1 Pack

## D2W™ Deck2Wall Spacers



Deck2Wall Spacers vs Washers

Designed to easily and efficiently provide airspace between buildings and deck ledgers, stair stringers, shade structures, railing posts, fence posts, and more to help prevent rot. Deck2Wall Spacers are easy to install. Simply fasten the spacer to the ledger with properly sized screws or nails through the attachment holes prior to bolting the ledger to the structure. The large diameter provides greater bearing surface than standard washers.

Item #	Description	Net Wt (10)
D2W58	Deck2Wall Spacer 2 1/2"	0.1 lbs
D2W58-10PK	(10) Deck2Wall Spacer 2 1/2"	1 lbs
D2W58-100	(100) Deck2Wall Spacer 2 1/2"	6.8 lbs
D2W38	Deck2Wall Spacers 2"	0.1 lbs
D2W38-10PK	(10) Deck2Wall Spacers 2"	1 lbs
D2W38-100	(100) Deck2Wall Spacers 2"	4 lbs



Space With Deck2Wall Spacers



**Made In The USA!**

## 7" Gutter Screws, Ceramic Coated Star Drive



**Includes Drive Bit!**

**.425" Head Diameter**

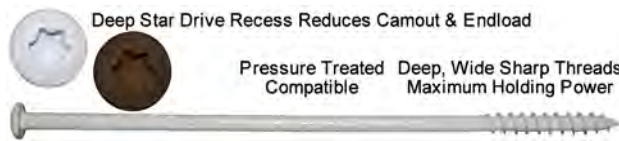

Deep Star Drive Recess Reduces Camout & Endload

Pressure Treated Compatible    Deep, Wide Sharp Threads    Maximum Holding Power

Gutter Screw Ceramic Coated Star Drive Screws in brown or white finish, #14 x 7". Includes TX30 bit. Conveniently packed in a reusable 250 piece pail, 50ct box and individually. Includes driver bit. Treated lumber compatible.

Item Number	Size	Drive	Net Wt*	Carton Qty	Jar Qty	Other Qty
GTR147B Brown	#14 x 7"	T30	13.9 lbs	250	50	Each
GTR147W White	#14 x 7"	T30	13.9 lbs	250	50	Each

## M2M Metal To Metal Screws



**Includes Drive Bit!**



**The Ultimate Metal to Metal Screw!** Our M2M Metal to Metal screw is the perfect option for getting through that heavy gauge steel! Great for metal joists and any job where metal to metal joinery is needed! It's advanced Tek, quadrex drive & superior strength make this screw a sure win! Use a #2 square. 16 threads per inch. • # 3 Point • Drilling capacity 0.110 (12 gauge) – 0.179 (7 gauge) • Application: low profile design provides added clearance for standing seam roof or a concealed fastener panel system • Suggested Tool: Screwgun (1800-2500 RPM) with clutch depth sensitive nose piece.

Item Number	Size	Drive	Net Wt*	Carton Qty	Lge Jar Qty	Med Jar Qty	Sml Jar Qty	Head Diam.
M2MQC-101634	10-16 x 3/4"	#2 Sq	47.4 lbs	7500	1000	500	100	.45"

## Phillips Drive Modified Truss Head K-Lath Screws



**Includes Drive Bit!**



Our new self-drilling Modified Truss Head screws are for metal to metal applications. They feature a Phillips Drive, Zinc plating for corrosion resistance, a low profile modified truss head, and include a #2 Phillips Bit. Available in 20lb Bulk Pails and 1lb & 5lb Jars.

Item Number	Size	Drive	Net Wt*	Carton Qty	5lb Jar Qty	1lb Jar Qty
MT-0812D	8 X 1/2"	#2	20lbs	6060	1515	303
MT-0834D	8 X 3/4"	#2	20lbs	4444	1111	222
MT-08114D	8 X 1-1/4"	#2	20lbs	3226	806	161

## Phillips Bugle Head Drywall Screws



**Includes Drive Bit!**

**.32" Head Diameter**

**Easy Drywall Installation!**

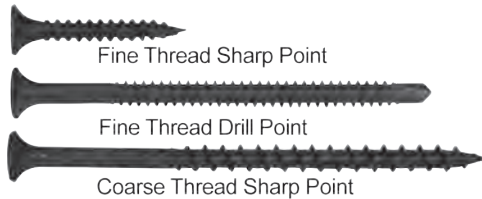
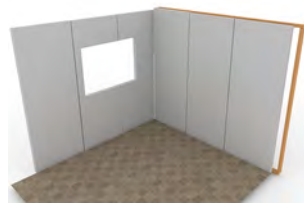

Our drywall screws have a bugle head to prevent tearing, a phosphate coating to help resist corrosion, and a phillips drive recess. They are excellent for wall board, drywall, plaster board, sheet rock, gypsum board, and other materials.

Item Number	Size	50lb Box Qty	Bulk Pail Weight	Bulk Pail Qty	20lb Pail Qty	5lb Jar Qty	1lb Jar Qty
DW-6118F	6 X 1-1/8"	13,800	36.2 lbs	10,000	5,520	1,380	276
DW-6114C	6 X 1-1/4"	12,900	31.0 lbs	8,000	5,160	1,290	258
DW-6158C	6 X 1-5/8"	10,050	27.4 lbs	5,500	4,020	1,005	201
DW-8200C	8 X 2"	6,750	25.9 lbs	3,500	2,700	675	135
DW-8212C	8 X 2-1/2"	5,300	23.6 lbs	2,500	2,120	530	106
DW-8300C	8 X 3"	4,450	28.1 lbs	2,000	1,780	445	89
<b>Drill Point</b>							
DW-06114D	6 X 1-1/4"				5,010	1,244	250
DW-06158D	6 X 1-5/8"				40,37	992	200
DW-08258D	8 X 2-5/8"				1,947	486	98

## Ceramic Coated Star Drive Cement Board Screws



*Includes Drive Bit!*

**.409" Head Diameter  
Cement Panels!**



Cement Board Ceramic Coated Star Drive Screws, Includes TX25 bit and conveniently packed in reusable containers. Deep sharp threads with a sharp point. Includes driver bit. Great for use with all cement boards. Treated lumber compatible.

Item Number	Size	Drive Size	Net Wt*	Carton Qty	5lb Jar Qty	1lb Jar Qty
CB114S (Sharp Point)	#8 x 1-1/4"	T25	30.9 lbs	5,000	795	159
CB158S (Sharp Point)	#8 x 1-5/8"	T25	30.8 lbs	4,000	650	130
CB114D (Drill Point)	#8 x 1-1/4"	T25	29.6 lbs	5,000	882	177
CB158D (Drill Point)	#8 x 1-5/8"	T25	28.5 lbs	4,000	709	144

## Tapcon Masonry Screws (Phillips or Slotted Hex Head)



**3/16" Screw Head  
Diameter .35"  
1/4" Screw Head  
Diameter .454"**

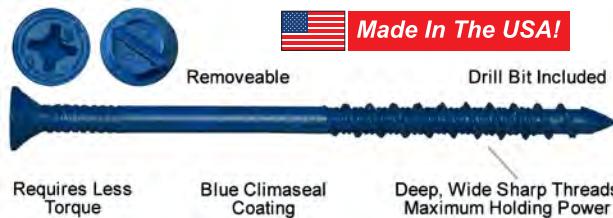

Tapcon Masonry Phillips and Slotted Hex Head Screws are milled with a Blue Climaseal® Coating for longer life. Fast and easy installation, removable, and the Advanced Threadform Technology requires less torque resulting in less end user fatigue. Great for securing all applications to concrete.

Item Number	Size	Drive	Net Wt*	Carton
PFH3134	3/16" x 1-3/4"	Phillips	0.9 lbs	(includes Drill Bit) 100
PFH3214	3/16" x 2-1/4"	Phillips	1.2 lbs	(includes Drill Bit) 100
PFH3314	3/16" x 3-1/4"	Phillips	1.7 lbs	(includes Drill Bit) 100
PFH4314	1/4" x 3-1/4"	Phillips	2.8 lbs	(includes Drill Bit) 100
HH3134	3/16" x 1-3/4"	Slotted Hex	0.9 lbs	(includes Drill Bit) 100
HH3214	3/16" x 2-1/4"	Slotted Hex	1.2 lbs	(includes Drill Bit) 100
HH3314	3/16" x 3-1/4"	Slotted Hex	1.7 lbs	(includes Drill Bit) 100

# THE ULTIMATE

## WINBAG® Inflatable Reusable Shims

MAHE **IBS** 2016 NEW AWARD WINNING TOOL

Announcing a **MUST** for every toolbox!



The WINBAG® is a very powerful hand operated inflatable air shim made of fiber reinforced material that will save you countless hours on the jobsite. It is designed to provide a maximum pressure of up to 300 lbs. and can be used in conjunction with shims and wedges in a wide variety of applications.

The WINBAG® gives the user infinite adjusting possibilities; save time installing windows, positioning heavy doors and leveling furniture, kitchen cabinets and household appliances just to name a few practical uses.

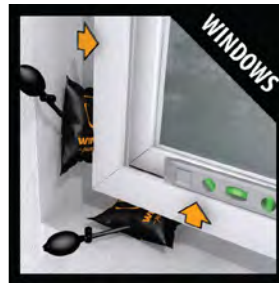

Tower Display

#17801  
5pc Stingray



Counter Display

10% off orders of 100 pcs or more on WINBAG

Item #	Item Description	Minimum Order Qty
17801	STINGRAY - Single Stingray with 5 WINBAGS	Carton of 5 Stingrays
15730	WINBAG - Single	20 WINBAGS
16054	<b>Available Upon Request</b> WINBAG - Free Counter Display Unit with minimum purchase of 20 (Single) WINBAGS	
15769	<b>Available Upon Request</b> WINBAG - Free Tower Display Unit with minimum purchase of 50 (Single) WINBAGS	

**Maximize Your Potential!** One carton of 5 Stingrays gives you the opportunity to hang a set in five different areas of your store!

- Cabinetry
- Doors
- Windows
- Appliances
- Contractor Desk
- Tools
- Levels
- Shims
- And More!

[WWW.SCREW-PRODUCTS.COM](http://WWW.SCREW-PRODUCTS.COM)

9401 Bujacich Rd. Bldg 1B, Gig Harbor, WA 98332  
Toll-Free 1-877-844-8880

Weights and counts subject to change without notice.

THE ULTIMATE FASTENERS

FOLLOW US



#SCREWPRODUCTSINC

## Star Drive Bits & Bit Holders

Drive	1" (25)	2" (25)	1" (100)	2" (100)	2-3/4" (10)	3-1/2" (10)	6" (10)	1" and 2" Bits Available In 100ct Jars!
TX10	•	•	•	•	<i>High Quality, Long Lasting Bits!</i>			<p><b>Impact Driver Ready!</b></p> <p>1" and 2" Bits Available In 100ct Jars!</p>
TX15	•	•	•	•				
TX20	•	•	•	•	•	•	•	
TX25	•	•	•	•	•	•	•	
TX30	•	•	•	•				
TX40	•	•	•	•				
2PMBH213	C-Ring 2 pc SS Magnetic Bit Holder 2-1/3" <i>For 1" Bits Only</i>							
2PMBH6	C-Ring 2 pc SS Magnetic Bit Holder 6" <i>For 1" Bits Only</i>							
SS1PMBH3	C-Ring 1 pc SS Magnetic Bit Holder <i>For 1" Bits Only</i>							
QR213	Quick Release Magnetic Bit Holder 2-1/3"							
SPRMBH	SuperMag Magnetic Bit Holder							

## HOLDSaBIT



**Made In The USA!**

Introducing the HOLDSaBIT! Simply the easiest and best way to hold multiple insert drill bit driver tips on your cordless drill or impact. It goes on and off in seconds and holds up to 16 - 1" bit drivers, as well as 1000's of combinations of bits. The HOLDSaBIT slips on a cordless drill or impact in seconds, providing channels that hold all the tips you need for your projects. Made of a proprietary blend which provides strength & holding power at the same time. UV rated for outdoor use. Fits all full sized cordless drill and drivers.



**Here are a few things you can place in your HOLDSaBIT:**

- Bits - Star, Torx, Square, Phillips, Straight - From 1" to 4"
- Hex shank drill bits • Nut drivers • Pencils/Pens
- Magnetic tip holders, and many, more tools



Item Number	Description	Included Bits in HAB8:
HAB8	HOLDSaBIT With 8 bits	<ul style="list-style-type: none"> <li>• (1) 2" TX10</li> <li>• (1) 2" TX15</li> <li>• (2) 2" TX20</li> <li>• (2) 2" TX25</li> <li>• (1) 2" TX30</li> <li>• (1) 2" TX40</li> </ul>
HAB815	15 ct Jar of HOLDSaBIT With 8 bits	
HAB	HOLDSaBIT Only	
HAB15	15 ct Jar of HOLDSaBIT Only	

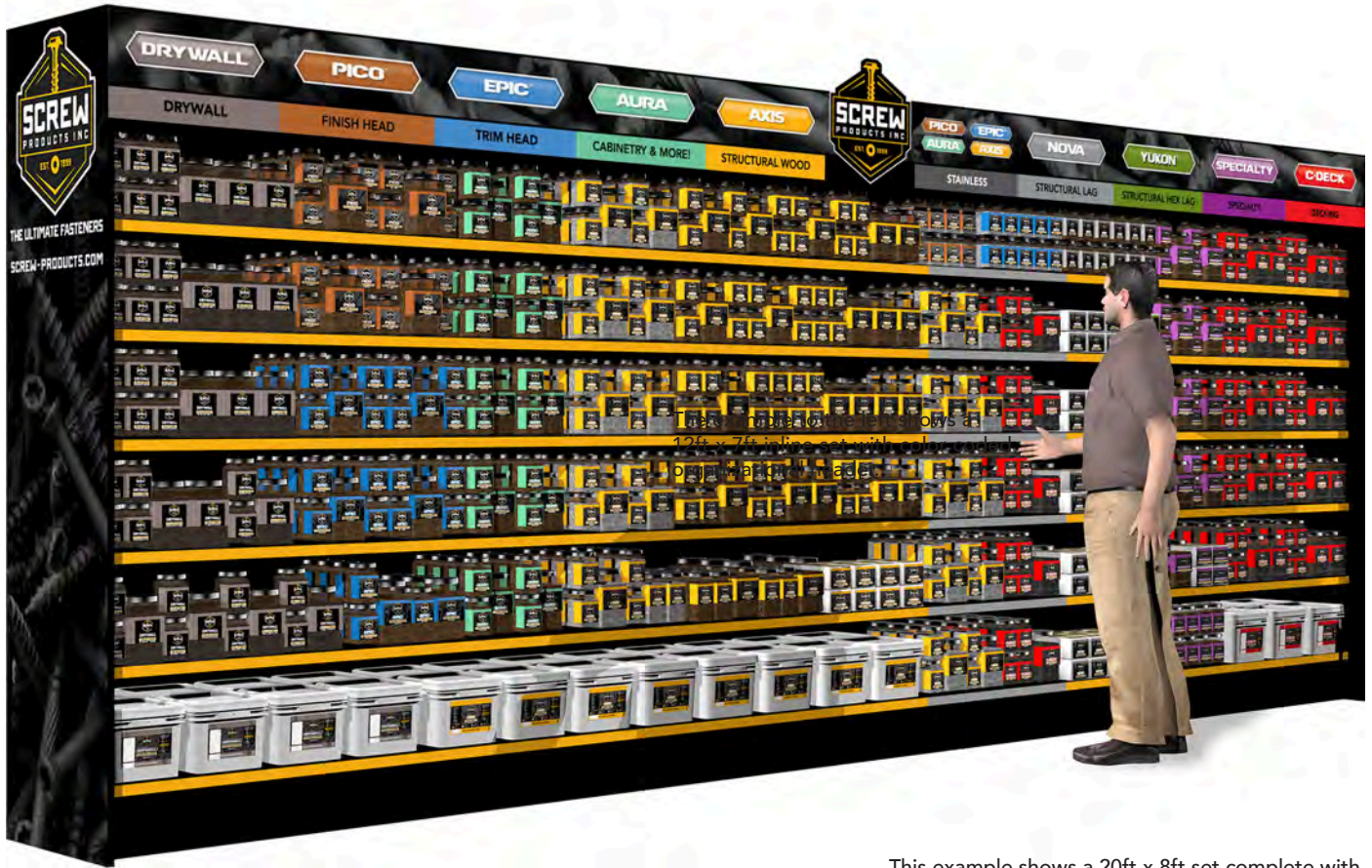

This example shows a 20ft x 8ft set complete with sideboards and color coded organizational header.



Example 4ft x 6ft Standalone Set



Example 8ft x 7ft Standalone Set

## Make An Impact!

We offer custom tailored sets to your store's customers and potential! Whether you are by the Ocean Shores or inland, we'll work with you to put together the set that's right for you.

From fastener type specific to our full line of fasteners, hardware and accessories; we'll help you put together an attention getting set that makes it easy for your customers to find what they need quickly.

Speak with your Screw Products, Inc. Representative for more information!

**WWW.SCREW-PRODUCTS.COM**  
 9401 Bujacich Rd. Bldg 1B, Gig Harbor, WA 98332  
 Toll-Free 1-877-844-8880

Weights and counts subject to change without notice.

**THE ULTIMATE FASTENERS**

FOLLOW US



#SCREWPRODUCTSINC



**THE ULTIMATE FASTENERS**

**WWW.SCREW-PRODUCTS.COM**  
9401 Bujacich Rd. Bldg 1B, Gig Harbor, WA 98332  
Toll-Free 1-877-844-8880

**THE ULTIMATE FASTENERS**

FOLLOW US



#SCREWPRODUCTSINC

Jun 1, 2020