



Architectural  
guide

For more than 100 years,  
Allegion brands have been  
providing innovative security  
solutions ranging from  
wireless security products  
and biometrics to high  
security mechanical locking  
systems.

With a wide range of solutions and services, Allegion has what you need, no matter how demanding your project specifications may be. And we stand behind every product we make with some of the best service and support in the business. It's this commitment to design, performance and technology that ensures you can stand behind our products too.



## Table of contents

<b>4</b>	<b>STEELCRAFT</b>	<b>94</b>	<b>LCN</b>
6-7	Frames	98-100	4000 Surface Mounted Closers
8	Flush doors	101-102	1000 Slim Surface Mounted Closers
9	Full glass entrance doors	103	High security closers
10	GRAINTECH™ doors	104	Concealed closers
11	Severe weather doors	105-106	Fire/life safety solutions
12-13	Specialty doors and applications	107	LCN finishes
14-15	Fire-rated doors and frames	108-111	Automatic operators and accessories
<b>16</b>	<b>SCHLAGE ELECTRONICS</b>	<b>112</b>	<b>GLYNN-JOHNSON</b>
18	NDE Series wireless electronic locks	113-114	Overhead door holders/stops
19-22	AD Series networked electronic locks	115	Push/pull latches
21	CT5000 Offline Controller	<b>116</b>	<b>VON DUPRIN</b>
23-24	CO Series standalone electronic locks	118-119	Popular options
26-27	Biometric HandReaders	120	98/99 Series touchbar exit devices
28	Electromagnetic locks	121	98/99 Series trim options
29	PS900 Series power supplies	122	33A/35A Series touchbar exit devices
30	System accessories	123	33A/35A trim options
31	Warranties	124-125	INPACT® recessed exit devices
<b>25</b>	<b>aptiQ®/XceedID®</b>	126	55 Series crossbar exit devices
25	Readers	126	88 Series crossbar exit devices
25	Credentials	128	Power transfer
<b>32</b>	<b>SCHLAGE MECHANICAL</b>	127	22 Series touchbar exit devices
34-35	Mechanical lock guide	127	GUARD-X®
36-40	L Series Grade 1 mortise locks	128	Electric strikes
41	Vandlgard® and electrified locks	130	Finishes
42	ND Series Grade 1 cylindrical locks - levers	131	Lever design options
43	D Series Grade 1 cylindrical locks - knobs	<b>132</b>	<b>FALCON</b>
44-45	B Series Grades 1 & 2 deadbolts	134	Heavy-duty commercial locksets
46	AL Series Grade 2 cylindrical locks - levers	135	Medium-duty commercial locksets
47	A Series Grade 2 cylindrical locks - knobs	136	Deadbolts
48	H Series cylindrical interconnected locks	137	24/25 Series touch bar exit device
50	S Series Grade 2 tubular locks	139	19 Series touch bar exit device
51	S200 Series Grade 2 tubular interconnected locks	139	XX Series cross bar exit device
52-53	Commercial finishes	140	1690/1789 Series concealed vertical rod touch bar exit device
54-55	Commercial grade portable security	141	1590 Series touch bar exit device
56-57	CL Series cabinet locks	141	1490 Series concealed vertical rod touch bar exit device
58-61	Key systems	142	Vertical rod devices
62-63	Interchangeable cores	142	Crossbar exit devices
64	Accessories and services	143	Accessories
65-68	Mechanical lock functions	144-145	Closers
<b>69</b>	<b>SCHLAGE RESIDENTIAL</b>	146	Electromechanical automatic operator
70-74	Electronics	<b>147</b>	<b>ZERO INTERNATIONAL</b>
75	Handlesets	148-149	Thresholds and ramps
76	Deadbolts	150-151	Traction tread™
77	Levers and knobs	152-153	Sill protection
78	Decorative trim	154-155	Head and jamb protection
79-80	J Series	156	Meeting stiles
81-82	Hardware and accessories	157	Flood barrier shield for doors
83-85	Multi-family	158-159	Sound trap
86	Mechanical interconnected locks	160	Hinges
<b>87</b>	<b>IVES</b>		
88	Architectural hinges, continuous hinges, and pivots		
89	Flush bolts		
90	Coordinators and dust-proof strikes		
91	Door trim		
92	Stops, roller latches and catches		
93	Surface bolts		
93	Architectural hardware finishes		



### Contents

#### Frames

#### Flush doors

#### Full glass entrance doors

#### GRAINTECH™ doors

#### Severe weather doors

#### Specialty doors

#### Specifications

#### Fire-rated frames and doors

### Steel doors and frames that set the industry standard

No other manufacturer offers as robust a selection of steel doors and frames as Steelcraft. Our sole focus is on the design, manufacture and constant improvement of steel doors and frames, and it shows. Designed for institutional, commercial and industrial applications, our doors and frames have continuously set the industry standard for high performance, reliability and style.

### Standard door construction features and benefits

- Beveled hinge and lock edges Tighter tolerances and opening fit with a  $\frac{3}{32}$ " gap, ensuring easier operation and eliminating binding and sticking
- Full height, epoxy-filled mechanical interlock edges Structural support and stability the full height of the door
- Universal hinge preparations Patented design creating fast and easy field conversion from the standard weight .134" to heavy weight .180" hinges
- True 7-gauge hinge reinforcements Strong internal support for hinges to keep the door from sagging during everyday use and abuse
- Recessed Dezigner™ glass trim Interior welds and fasteners, inset into a recessed perimeter channel for a clean, neat, and flush finish
- Screwed-in top caps Flush cap installed into top and bottom channels for additional protection from the elements, dirt and debris
- Heavy 14-gauge top and bottom channels Performance and stability for the top and bottom door edges
- Seamless edge Option creating a finished, one-piece look with clean lines
- Mortise lock body stabilizers Easier installation by centering the lock body in the door
- 61L cylindrical lock preparation Universal features accommodate any cylindrical lock in the market with a 3-7/16" or larger rose
- Structural honeycomb core design Greater structural integrity than steel stiffened doors while reducing overall weight, successfully tested to 10,000,000 cycles including 21 twist tests using 300 pounds of applied force. Optional cores for better insulating value include polystyrene, polyurethane, steel stiffened with fiberglass batting, and temperature rise mineral fiber board.
- Factory applied baked-on rust inhibiting primer Provides the best possible protection against corrosion, abrasion and weather, and is an excellent base for our finish paint in standard or custom colors. In accordance with ANSI A250.10-1998 (R2004).

# The only door good enough to be called Steelcraft



Recessed Dezigner™ glass trim

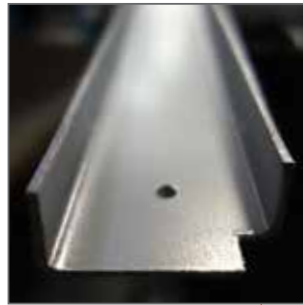

Heavy 14-gauge top and bottom channels



- Factory installed screw-in flush top and bottom caps
- Optional seamless vertical edges



Universal hinge preparations with true 7-gauge reinforcements



Mortise lock body stabilizers



- Structural honeycomb core design
- Optional cores:
- Polystyrene
  - Polyurethane
  - Steel stiffened - fiberglass batts
  - Temp rise mineral fiber board



- Beveled hinge and lock edges
- Full height, epoxy-filled mechanical interlock edges



61L cylindrical lock universal features

Descriptions on page 4.

## Frames

Steelcraft manufactures a wide variety of frames in jamb depths for virtually any wall condition or entryway requirement.

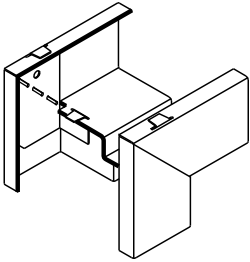

### Flush frames

Flush (F, FE and FN Series) frames are designed to be installed as part of the wall framing sequence for exterior and interior walls of wood stud, steel stud and masonry construction. Frames are manufactured from 16-, 14- and 12-gauge (F only) commercial-quality carbon steel in cold-rolled, A60 galvanized and G90 galvanized steel. Flush frame corners in 16 and 14-gauge may lock together by bending over four integral tabs, and may also be welded and ground smooth.

### Multiple use frames

Multiple use (MU Series) frames have a jamb profile similar to drywall frames but are designed to be installed as part of the wall framing sequence. MU Series frames are available in 16- or 14-gauge cold-rolled, A60 galvanized or G90 galvanized steel.

### Drywall frames

Drywall (DW and K Series) frames are designed to be installed in rough openings after the wall is constructed. They can be installed in minutes and can be relocated without damage to the frame. Drywall frame corners lock together once the frame is assembled. The tab design prohibits the head from raising, and keeps the head and jamb members in the same plane.

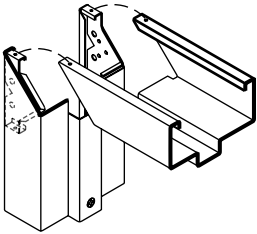

### Specifications

Door thickness	1 <sup>3</sup> / <sub>4</sub> " (45mm)	1 <sup>3</sup> / <sub>8</sub> " (35mm)	
Standard heights	6'8" (2032mm)	7'0" (2134mm)	7'2" (2184mm)
	8'0" (2438mm)	9'0" (2743mm)	10'0" (3048mm)
Standard widths	Increments of 2" (50mm) from 1'6" (457mm) to 8'0" (2438mm)		

Custom sizes per request.

### Typical wall conditions – F and FN Series

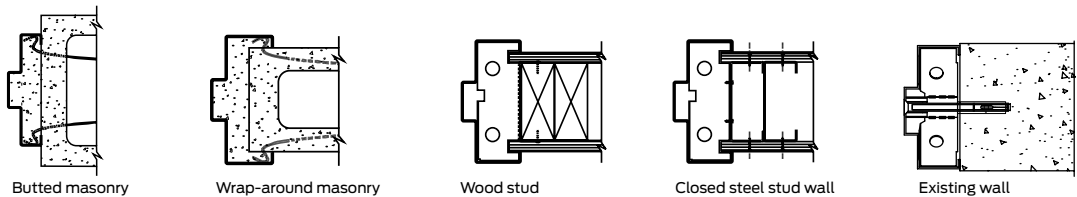

### Typical wall conditions – DW and K Series

Drywall frames are designed for drywall construction using wood studs or steel studs. DW and K Series frames are available in 16- or 14-gauge cold-rolled, A60 galvanized or G90 galvanized steel.

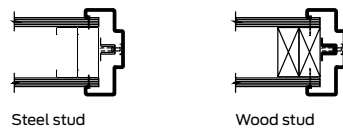

# Frames

## Anchors – F and FN Series



Adjustable wire anchor for masonry



Wood stud anchor



Closed steel stud anchor



Adjustable base anchor

## Anchors – DW and K Series



Lock in base anchor – DW Series



Quick and easy base anchor – K Series



Compression anchor – DW and K Series



Optional security anchor

## Design options

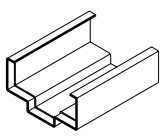

14-gauge closer reinforcing sleeve

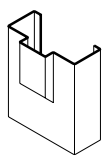

Hospital stop

(F, FN, DW, and MU Series only)

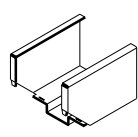

4" face head

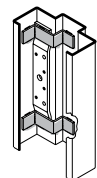

10-gauge high frequency reinforcement (F, MU, DW and FE Series only)

High frequency hinge reinforcement

## Frame profiles



DE Series



F Series



FE Series



MU Series



DW Series

## Relative cost

F16, 1 3/4" (45mm), 3'0" (914mm) x 7'0" (2134mm), 5 3/4" (147mm) prime painted, CRS knock down frame used as base of 100.

F16-4	CRS	16-gauge, 1 3/4" KD 100
F16-4	CRS 7'2"	16-gauge, 1 3/4" KD 102
F16-4	Galvannealed	16-gauge, 1 3/4" KD 114
F16-4	Label	16-gauge, 1 3/4" KD 116
FN16-4	CRS	16-gauge, 1 3/4" KD 100

F14-4	CRS	14-gauge, 1 3/4" KD 123
F12-4	CRS	12-gauge, 1 3/4" KD 161
DW16-4	Drywall	16-gauge, 1 3/4" KD 102
MU16-4	Multi-use	16-gauge, 1 3/4" KD 102



## Typical elevations

### Flush panel and glass doors

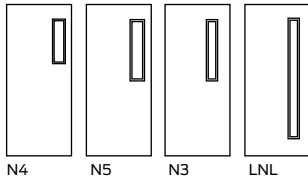
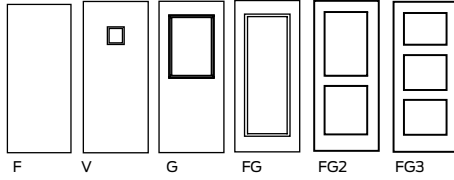

### Dutch doors Doors with louvers or grilles

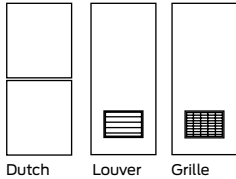

### Embossed panel doors

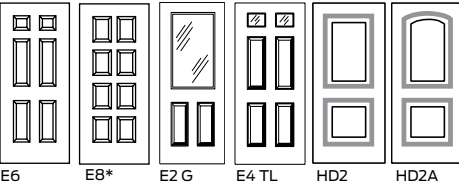

\*Available in 20-gauge only.

## Flush doors

Flush doors are defined as having no seams on the face, with seams permitted on the edges. Doors are available in commercial-quality carbon steel or A-60 galvanized steel, G-90 galvanized steel and stainless steel (Type 304 and 316).

### L Series

The L Series door has a honeycomb core, beveled hinge, and lock edge with a visible seam on both edges. Optional cores are polystyrene or polyurethane. L Series doors are available in 14-, 16-, 18- and 20-gauge steel.

### B Series

The B Series door has a steel-stiffened core with visible seams on the hinge and lock edges. 20-gauge vertical steel stiffeners are welded to the inside of one face sheet and bonded to the opposite face. Void areas between the stiffeners are filled with fiber bat insulation. B Series doors are available in 14-, 16- and 18-gauge steel.

### T Series

The T Series doors are designed to meet the requirements for temperature rise fire-rated applications. These doors include the same construction features of the L Series doors, yet include a mineral board core for a 250° or 450° temperature rise rating. T Series doors are available in 14-, 16-, 18- and 20-gauge steel.

### CE Series

CE Series are decorative doors featuring deeply embossed panels on both sides, creating the appearance of hand-carved doors. The door includes all construction features of the L Series door and is available with a variety of glass sizes. These doors are available in 16-, 18- and 20-gauge steel.

### H Series

H Series hurricane-rated doors offer the utmost in life safety solutions. Each door, frame and hardware configuration offered has been tested and certified as an assembly to meet stringent Florida Building Code and Miami Dade standards. With this approach of assembly approval, Allegion offers the assurance of a turnkey solution that is certified as a whole, while also expediting project approval.

### Paladin™ Series

The Paladin opening system is designed and tested to address the requirements of FEMA 361 and 320 guidelines, and those established by the Red Cross to protect the general public from the extreme environmental effects of tornadoes. The severe storm opening system is designed for commercial and residential tornado storm shelters.

## Specifications

Door thickness 1<sup>3</sup>/<sub>4</sub>" (45mm)

Standard heights	6'8" (2032mm)	7'0" (2134mm)
L and B Series	7'2" (2184mm)	8'0" (2438mm)
	9'0" (2743mm)	10'0" (3048mm)

Standard heights	6'8" (2032mm)	7'0" (2134mm)
CE Series	8'0" (2438mm)	

Standard widths	Increments of 2" (50mm)
L and B Series	from 1'6" (457mm) to 4'0" (1219mm)
	Custom dimensions available on request

Standard widths	Increments of 2" (50mm) from
CE Series	2'6" (762mm) to 3'8" (1118mm)

Custom sizes per request.

## Design options

### GRAINTECH™

GRAINTECH™ doors are L, T, H or CE Series doors, produced using steel sheets that have been embossed to create a wood grain appearance. GRAINTECH™ doors are fabricated from stainable steel and available with an optional factory finish in six standard color stains, including a factory-applied clear coat with ultraviolet (UV) inhibitors. GRAINTECH™ gives you the look of wood with the durability and fire-rating of a steel door.



## Full glass entrance doors

Steelcraft heavy-duty A-14 Series doors provide trouble-free service and attractive styling for high traffic areas such as main entrances.

### A-14 Series

The A-14 Series doors are designed to meet the architectural requirements for exterior entrance applications. It has a honeycomb core, beveled hinge and seamless edges with full height, epoxy filled with interlocked edges. The A-14 Series doors are available for high frequency openings and entrances where large full glass lights are required.

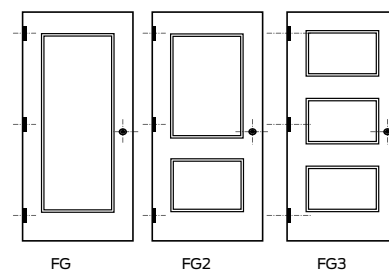

### Specifications

Door thickness	1 <sup>3</sup> / <sub>4</sub> " (45mm)	
Standard heights	6'8" (2032mm)	7'0" (2134mm)
A-14 Series	7'2" (2184mm)	8'0" (2438mm)
Standard widths	Increments of 2" (50mm) from 1'6" (457mm)	
A-14 Series	to 4'0" (1219mm)	

Custom sizes per request.

### Get flexible performance with removable keyed mullions.

Mullions provide single door performance in double door openings with rim exit devices. Keyed removable mullions make removal faster and easier by a single operation of the mortise cylinder. The unit will self-lock when re-installed without the use of a cylinder key.

When ordering, specify KR before the mullion model number.

For more information see page 117.



### Relative cost

L18, 1<sup>3</sup>/<sub>4</sub>" (45mm), 3'0" (914mm) x 7'0" (2134mm) flush door used as base of 100.

L18	Flush, 18-gauge	100	B18	Flush, 18-gauge, steel stiffened	125
L20	Flush, 20-gauge	87	B16	Flush, 16-gauge, steel stiffened	149
LF20	Flush, 20-gauge	96	BW16	Flush, 16-gauge, steel stiffened (edge welded)	161
L18	Galvannealed, flush, 18-gauge	113	B14	Flush, 14-gauge, steel stiffened	173
L18	UL flush, 18-gauge	115	CE20	Embossed, 20-gauge	105
L18	Finished paint, flush, 18-gauge	116	CE18	Embossed, 18-gauge	122
LF18	Full flush, 18-gauge (edge filled)	110	CE16	Embossed, 16-gauge	139
LW18	Full flush, 18-gauge (edge welded)	112	L16	Stainable, 16-gauge, factory finished	149
T18	UL temperature rise, 18-gauge	154	L18	Stainable, 18-gauge, factory finished	143
L16	Flush, 16-gauge	123			
LF16	Flush, 16-gauge (edge filled)	133			
LW16	Flush, 16-gauge (edge welded)	139			
L14	Flush, 14-gauge	148			

# STEELCRAFT®

GRAINTECH™ doors the beauty of wood, the strength of steel



Steelcraft's GRAINTECH Series of stainable steel doors provides the beauty of wood with the features and benefits of steel. Our exclusive engraving and staining process simulates a wide variety of wood finishes, from ash to walnut, including custom finish matching.

GRAINTECH doors are available in a wide variety of options including size, glass lite designs, gauges and hardware preps, and are designed for interior and exterior applications.

Unlike veneered or solid wood doors, GRAINTECH is fully warranted for use on exterior openings, is less susceptible to damage, and will never warp, crack, peel or bow. It is also available in CE Series panel doors, L Series flush doors, T Series temperature rise doors, and H Series hurricane doors. The GRAINTECH Series is available with a full range of positive pressure fire-ratings, from 20 minutes to three hours.

## Glass Lite Options

Flush doors (L Series and T Series)

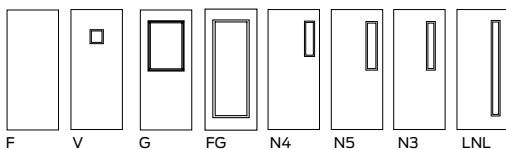

Embossed panel doors (CE Series)

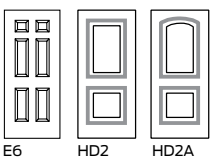

\*Available in 20-gauge only.

## CE Series GRAINTECH Doors

- Six-panel embossed design
- Available in 16-gauge heavy-duty or 18-gauge extra heavy-duty
- Available in six standard finishes, as well as custom-matched finishes
- Half-glass and top-lite available featuring Designer trim, a Steelcraft exclusive
- Polystyrene core system for structural integrity
- Fire-rated 20 minutes to three hours

## L Series GRAINTECH Doors

- Laminated flush design
- Available in 16 or 18-gauge to fit any application from standard to extra heavy-duty
- Available in six standard finishes, as well as custom-matched finishes
- Half-glass, narrow lite, vision lite or custom size lites featuring Designer trim, a Steelcraft exclusive
- Available with honeycomb, polystyrene or polyurethane insulated cores

## T Series GRAINTECH Doors

- Temperature rise-rated full-flush design
- Available in 16 or 18-gauge to fit any application from standard to extra heavy-duty
- Available in six standard finishes as well as custom matched finishes
- Mineral board core provides a 250° or 450° temperature rise-rating

## GRAINTECH Standard colors



Ash Birch Mahogany Maple Oak Walnut  
Colors may vary based on your monitor, printer, and settings. Request a GRAINTECH swatch for color matching



## Severe weather doors

### Tough weather protection

Whether you're in a coastal area subject to hurricane-force storms, or in one of the many areas across the country at risk for tornadoes, Steelcraft has a tough, dependable door system that can take whatever nature dishes out. Our Paladin tornado doors and H Series hurricane-rated doors are built to exacting standards that ensure tough protection when it's needed most.

### Standard construction for both Paladin and H Series Doors

- **A60 galvanized steel for superior corrosion resistance** on exterior openings
- **Full height lock-side reinforcement channel** ensures structural stability and locking hardware functionality under extreme pressure conditions
- **Full height, epoxy-filled mechanical interlock edges** provide structural support and stability the full height of the door edges
- **Patented universal hinge preparations** allow for easy field conversion from standard-weight hinges to heavy-weight hinges
- **14-gauge top and bottom channels** provide stability and protection from abuse for the top and bottom edges
- **Beveled hinge and lock edges** allow for tighter tolerances, ensure easier operation, and eliminate binding and sticking
- **Recessed Designer glass trim** provides a clean, neat and flush finish with the door surface\*
- **Factory-applied baked-on rust inhibiting primer** in accordance with ANSI A250.10

\*Not available on Paladin

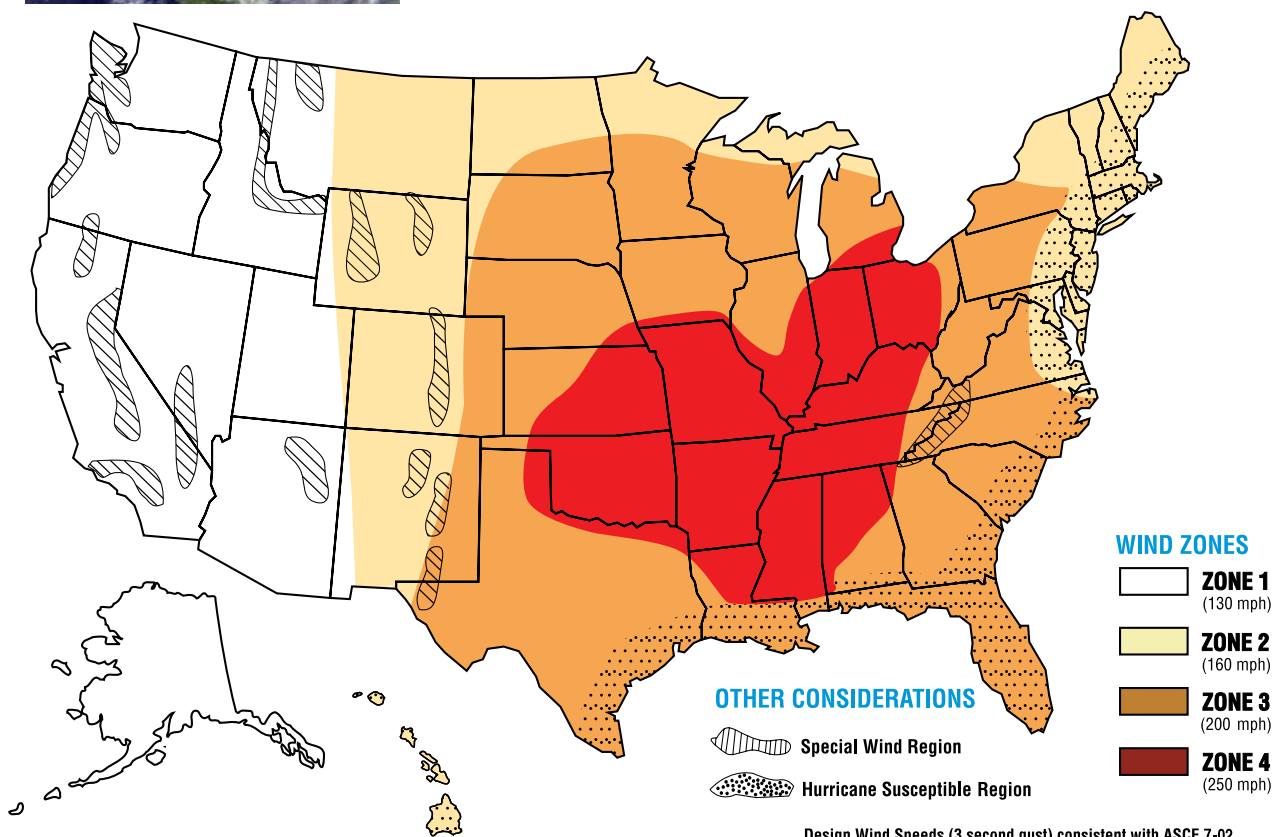

**WIND ZONES**

	<b>ZONE 1</b> (130 mph)
	<b>ZONE 2</b> (160 mph)
	<b>ZONE 3</b> (200 mph)
	<b>ZONE 4</b> (250 mph)

**OTHER CONSIDERATIONS**

- Special Wind Region
- Hurricane Susceptible Region

Design Wind Speeds (3 second gust) consistent with ASCE 7-02

American Samoa, Puerto Rico, Virgin Islands    Guam

**Note:** always reference local codes for specific jurisdiction requirements.





## Acoustical doors

### Acoustical doors

Now you can get special application doors from the same source as your standard steel doors with the same lead time. Steelcraft sound control doors and frames are an ideal solution for applications ranging from sound studios to school band rooms, hospitals, office complexes and museums. These special-use doors deliver quality you can count on.

Note: STC ratings vary by door series and core type, please see the Specialty Section of our Technical Data Manual for a complete listing.



## Steelcraft high definition doors - sophisticated style, core strength

### Exterior finish fits any decor

From executive office settings to multi-family housing units to university conference facilities, the Steelcraft commercial embossed high definition two panel doors enhance any environment. Crafted detailing gives these doors a face of beauty and elegant style that's sure to upgrade the appearance of your setting. Available in standard paint or GRAINTECH finishes, these doors feature two inset panels with deep shadow detail and your choice of straight cut or arched top design.

### Interior designed for durability

Steelcraft construction combines the strength and dimensional stability of steel with the structural integrity of our laminate core. Our process of continuous bonding seals the core to steel face sheets for a flat door finish, free of face welding marks. Lab studies prove this door outperforms all others in its class, meeting the requirements of fire-rated doors from 20 minutes to 3 hours.



HD2A



HD2

## Factory finish paint

Steelcraft's factory finish paint offers a variety of popular standard color choices along with custom match options. The finish paint is applied to our quality commercial grade doors, carefully packaged and supplied to our customer, pre-finished. Our efficient method of application and pre-finished delivery saves in money and time - from a brand you know and trust.

### Our 16 standard color options:



Rookwood brown  
P2807



Downing earth  
P2820



Downing stone  
P2821



Downing sand  
P2822

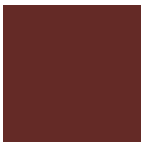

Aurora brown  
P2837



Weathered shingle  
P2841



Chelsea gray  
P2850



Black bean  
P6006

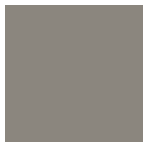

Spalding gray  
P6074



Blonde  
P6128



Mannered gold  
P6130



Burgundy  
P6300



Luxurious red  
P6314



Sierra redwood  
P7598



Poolhouse  
P7603



Homberg gray  
P7622



Cascades  
P7623



Raisin  
P7630



## Stainless steel doors and frames

### LS Series doors and FS Series frames

Steelcraft stainless steel LS series doors and FS Series frames utilize all stainless steel construction including reinforcement components and anchors. Available in either 304 or 316 alloy for maximum durability and corrosion protection. Designed and built to withstand the harshest environments.

In addition to standard flush and panel doors, custom doors are available in a wide range of polished, embossed and etched finishes. The nearly unlimited choice of design options can provide you the performance and creative look to meet your special project needs.

Doors are seamless with interlocking edge; core options include polystyrene, honeycomb or polyurethane. Stainless steel stiffeners are epoxy-glued to eliminate surface imperfections associated with welding.

#### Available ratings:

- Three hour Class A fire-rated
- STC 51 sound rated
- Hurricane approved

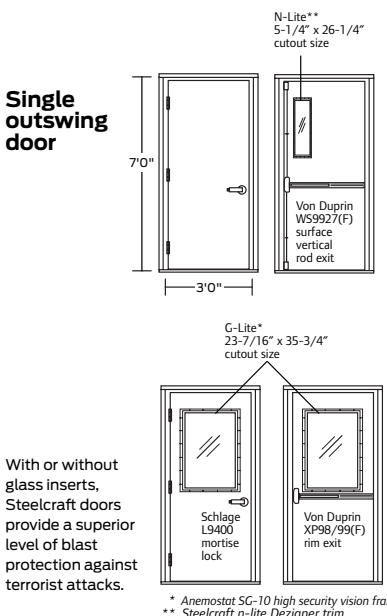

## Blast-resistant ratings standard doors, specialty performance

### Superior protection in an uncertain world

From military installations and government facilities to hospitals and office buildings, some locations demand an extra layer of safety. Steelcraft meets that demand with proven blast-resistance glazing on its most popular honeycomb and steel-stiffened core models. Tested (ASTM F1642) under the most stringent United States Department of Defense guidelines, Steelcraft doors offer your building occupants an increased level of personal security.

### Setting the industry standard







Traditionally, construction managers have been forced to rely on specialty manufacturers for doors built to withstand blast impact. Among Steel Door Institute (SDI) members, Steelcraft has invested in the testing and meets the top blast-resistant rating of No Hazard. With a peak blast pressure rating of up to 10.3 psi and a positive phase duration of up to 26 milliseconds, you won't find a better way to build in protection.

# STEELCRAFT®

## Fire-rated frames

### Frame type

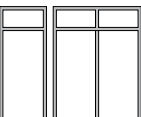
### Frame size

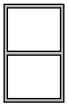
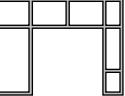
Three sided frames	Max. overall size	Max. door size	Max. rating	Jamb depths	Max. panel size	Max. glass area
 <p><b>F16, FN16 F14, FN14, F12</b></p>		4'0" x 10'0" single (1219mm x 3048mm) 8'0" x 10'0" pair (2438mm x 3048mm)	3 hour	Min. 3" (75mm) Max. 14" (350mm) Max. 20" (F16 and F14 masonry)		
 <p><b>DW16, K16 DW14, K14</b></p>		4'0" x 8'10" single (1219mm x 2692mm) 8'0" x 8'10" pair (2438mm x 3048mm)	1 1/2 hour	Min. 3 1/2" (121mm) Max. 14"		
 <p><b>F14</b></p>		4'0" x 8'0" single 8'0" x 8'0" pair	3 hour	Min. 5 3/4" (146mm) Max. 10 3/4" (273mm)		
 <p><b>Transom frames with panel, without bar</b></p>	4'4" single (1319mm x 3505mm) 8'4" pair (2538mm x 3505mm) 11'4" OA height	4'0" x 8'0" single (1219mm x 2438mm) 8'0" x 8'0" pair (2438mm x 2438mm)	3 hour - masonry 1 1/2 hour - stud (10'2" OA height)	Min. 3" (121mm) Max. 14" (324mm)	8'0" x 4'0" (2438mm x 1219mm)	
 <p><b>Transom frames with bar</b></p>	<b>F16, F14 MU16, MU14 FN16, FN14</b>	4'4" x 12'2" single (1319mm x 3531mm) 8'4" x 12'2" pair (2538mm x 3531mm) without mullion 8'6" x 12'2" (2590mm x 3531mm) with mullion	4'0" x 10'0" single (1219mm x 3048mm) 8'0" x 10'0" pair (2438mm x 3048mm)	1 1/2 hour	Min. 3" (121mm) Max. 14" (324mm)	8'0" x 3'2" (2438mm x 965mm) Per glass mfr.
 <p><b>Borrowed lite frames</b></p>	<b>F16, F14 MU16, MU14 FN16, FN14</b>	13'2" x 12'2" (4013mm x 3531mm) stud wall  13'6" x 12'2" masonry		1 1/2 hour	Min. 3" (121mm) Max. 14" (324mm)	Per glass mfr.
 <p><b>Borrowed lite frames</b></p>	<b>DW16, DW14</b>	8'4" x 7'2" single (2540mm x 2184mm) 4'4" x 9'0" (with Loriz rem mullion)		1 hour	Min. 3 1/2" (121mm) Max. 14" (324mm)	Per glass mfr.
 <p><b>Transom/sidelite frames</b></p>	<b>F16, F14 MU16, MU14 FN16, FN14</b>	13'2" x 12'2" (4013mm x 3531mm) stud wall  13'6" x 12'2" masonry	4'0" x 10'0" single (1219mm x 3048mm) 8'0" x 10'0" pair (2438mm x 3048mm)	1 1/2 hour	Min. 3" (121mm) Max. 14" (324mm)	Transom or side panel 8'0" x 3'2" 2438mm x 965mm) Per glass mfr.

Interior dividing members may have a minimum 1" (25mm) face. Maximum size frame available will vary with wall construction. See Steelcraft spec sheets for exact sizes. Approved glazing required in all fire-rated products.

## Fire-rated doors

### Maximum glass area for labeled doors

Label	A	B	C	D*	E*		
<b>Rating</b>	3 hour	1½ hour	¾ hour	1½ hour	¾ hour	20 minutes	
<b>Max. glass area</b>	100 sq. in. (0.6 sq. m)	1850 sq. in. <sup>2</sup> mfg. (1.19 sq. m) list	2700 sq. in	none	2700 sq. in (1.74 sq. m)	as tested	

\*Exterior rated openings Firelite glass [1296 sq. in. (84 sq. M)] with Firelite glass.

### Single doors label rating

Doors	Max. size	3 hour	1½ hour	¾ hour	1½ hour	¾ hour	20 minute
<b>L20</b>	3'0" x 7'2" (914mm x 2184mm)	A	B	C	D	E	✓
<b>L20</b>	3'0" x 8'0" (914mm x 2438mm)		B	C	D	E	✓
<b>L18, L16</b>	4'0" x 10'0" (1219mm x 3048mm)		B	C	D	E	✓
<b>L14</b>	4'0" x 10'0" (1219mm x 3048mm)	A	B	C	D	E	✓
<b>B18, B16</b>	4'0" x 10'0" (1219mm x 3048mm)	A	B	C	D	E	✓
<b>B14</b>	4'0" x 8'0"/10'0" (1219mm x 2438mm/3048)	A - 8'0" 4'0" x 8'0"	B - 10'0"	C - 10'0"	D - 10'0"	E - 10'0"	✓ - 10'0"
<b>A14</b>	4'0" x 8'0" (1219mm x 2438mm)		B - (FG2, FG3)	C - (FG, FG2, FG3)		E - (FG2, FG3)	✓ - (FG, FG2, FG3)
<b>T20, T18 T16, T14</b>	4'0" x 9'0" (1219mm x 2438mm)	A - 250° temp. rise	B - 250° or 450° temp. rise				
<b>CE20, CE16</b>	3'0" x 9'0" (914mm x 2134mm)	A - (3'0" x 7'0" CE20)	B	C	D	E	✓
<b>CE18</b>	3'8" x 8'0" (1118mm x 2438mm)	A	B	C	D	E	✓
<b>PW14</b>	4'0" x 8'0" single 8'0" x 8'0" pair	A	B	C			✓
<b>H16/H14</b>	4'0" x 8'0" single 8'0" x 8'0" pair	A	B	C			✓
<b>TH16/TH14</b>	4'0" x 8'0" single 8'0" x 8'0" pair	A	B - (100 sq in max.)				
<b>HD16, HD18</b>	3'8" x 7'0" single 3'0" x 8'0" single	A	B	C	D	E	✓
<b>HD16, HD18</b>	7'4" x 7'0" pair 6'0" x 8'0" pair	A	B	C	D	E	✓

### Pair of doors label rating

Doors	Max. size	3 hour	1½ hour	¾ hour	1½ hour	¾ hour	20 minutes
<b>L20</b>	6'0" x 7'2" (1892mm x 2184mm)		B	C	D	E	✓
<b>L18, L16</b>	8'0" x 8'0" (2438mm x 2438mm)	A	B	C	D	E	✓
<b>L14</b>	8'0" x 10'0" (2438mm x 3048mm)	A - 8'0"	B - 9'0"	C - 9'0"	D - 9'0"	E - 9'0"	✓ - 9'0"
<b>B18, B16</b>	8'0" x 10'0" (2438mm x 3048mm)	A	B	C	D	E	✓
<b>B14</b>	8'0" x 8'0"/10'0" (2438mm x 2438mm)	A - 8'0"	B - 10'0"	C - 10'0"	D - 10'0"	E - 10'0"	✓ - 10'0"
<b>A14</b>	8'0" x 8'0" (2438mm x 2438mm)		B - (FG2, FG3)	C - (FG2, FG3)		E - (FG2, FG3)	✓ - (FG, FG2, FG3)
<b>T20, T18 T16, T14</b>	8'0" x 9'0" (2438mm x 2743mm)	A - 250° temp. rise	B - 250° or 450° temp. rise (FG2, FG3)				
<b>CE20</b>	6'0" x 7'0" (1892mm x 2134mm)		B	C	D	E	✓
<b>CE18</b>	7'4" x 8'0" (2235mm x 2438mm)	A	B	C	D	E	✓
<b>CE16</b>	6'0" x 8'0" (1892mm x 2438mm)	A	B	C	D	E	✓

L, B, T, H Series label doors are available with the seams filled or welded. Doors over 8'0" (2438mm) high require two pair of heavy-weight hinges.  
Note: Consult the factory or an authorized Steelcraft distributor for specific fire-rated applications.



Commercial electronics

## Contents

### Schlage

NDE Series electronic lock with ENGAGE™ technology

AD Series networked electronic locks

CO Series standalone electronic locks

CT5000 Offline Controller

Biometrics

Electromagnetic locks

Power supplies

Accessories

### aptiQ/XceedID

Readers and credentials

### Warranties

While mechanical hardware is the foundation of our business, security lies in addressing the needs of an increasingly connected world. Electronic solutions don't replace mechanical products – they add innovative functionality, simplicity and flexibility. Our strength in mechanical security combined with our cutting edge interconnected electronic solutions, our open architecture technology, and expertise in style and design make us a respected leader in the marketplace.





**Take security to the next level with our portfolio of electronic solutions.**

Allegion is at the forefront of electronic access control with a comprehensive line of innovative hardware ranging from Schlage electronic locks to aptiQ® wall mount readers. Allegion's electronic product portfolio offers versatile, stylish and user friendly access control solutions to meet the security needs of virtually any facility—whether historic or new construction. For every type of building need, from schools and hospitals to office buildings and retail centers, our products are designed to provide the toughest, most reliable security no matter the application.



## NDE Series wireless electronic lock with ENGAGE™ technology

The Schlage® NDE Series wireless lock with ENGAGE™ technology is designed to be easy to install, connect, manage and use. Developed specifically for facilities that want to upgrade to electronic credentials for improved security and efficiency, it is ideal for interior office doors, common area doors and sensitive storage spaces. NDE Series wireless locks simplify installation by combining the lock, credential reader, door position sensor and request-to-exit switch all in one unit. NDE Series wireless locks utilize the standard ND cylindrical door prep and can be installed in minutes with only a Phillips screwdriver; no need to install additional components, drill holes or run wires to each opening. ENGAGE cloud-based web and mobile apps make it easy to configure lock settings, add users and view audits and alerts from anywhere. NDE Series wireless locks with ENGAGE technology are compatible with most proximity and smart cards including aptiQ® and aptiQmobile™.



### Features and benefits

- Built-in door position sensor on the lock and strike plate, eliminating the time and cost to install
- Fits standard mechanical cylindrical door prep with no additional holes
- Compatible with most leading key systems
- Available in a variety of finishes and lever styles to complement a facility's décor
- Certifications include ANSI/BHMA A156.25, ANSI/BHMA Grade 1, UL 294, UL 10C, FCC Part 15, ADA, RoHS, Industry Canada (IC)

### Lever/finish styles

Standard cylinders shown, SFIC and FSIC also available.



Sparta



Rhodes



Athens

### Warm tone finishes



605  
Bright brass



606  
Satin brass



612  
Satin bronze



643e  
Aged bronze

### Cool tone finishes



619  
Satin nickel



625  
Bright chrome

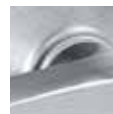

626  
Satin chrome

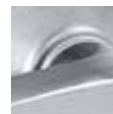

626AM  
Satin chrome  
with antimicrobial



## AD Series

Electronic locks



### AD Series: Networked and standalone electronic locking solutions

AD Series electronic locks from Schlage can be customized to fit the security needs of virtually any opening. Modular design and open architecture format allows them to adapt to any environment, today and in the future. The AD Series offers easy and affordable ways to grow a security system from a simple standalone solution to a more sophisticated networked access control solution.

AD Series locks can be ordered from the factory with a variety of customizable options that include credential reader type, chassis type, communication module, lever style and finish. As technology or needs change, the interchangeable reader heads can also be updated in the field without taking the lock off the door.

To simplify installation, AD Series combines all the access control hardware components required at the door into one integrated design that includes the electrified lock, credential reader, request-to-exit and -enter sensors, door position switch, tamper guard and more.



## AD Series - Networked electronic locks

AD-300 and AD-400 networked electronic locks from Schlage are modular, customizable and upgradeable by design, allowing them to fit the needs of any application now and adapt to meet future needs without removing them from the door. A wide variety of reader and communication modules are available and can be switched out on any AD Series lock, upgrading it to suit changing business needs.

Built on an open architecture platform, AD-300 and AD-400 networked electronic locks feature open architecture and are designed to adapt to any environment, enabling streamlined integration with virtually any access control system a facility uses. Networked AD Series locks offer a number of field-configurable features as well as a wide variety of capabilities that integrate with most leading access control software providers.

### Features

- Multiple panel interface options help ensure seamless communication with your existing access control system
- Secure encrypted data transmission
- Field configurable fail-safe/fail-secure and other capabilities
- Compatible with major brands of master key systems
- FIPS 201-1 compliant reader modules available for government applications
- Variety of lock capabilities that can be monitored by your existing access control panel
- ANSI/BHMA A156.25, ANSI/BHMA Grade 1, UL 294, UL10C, FCC Part 15, ADA, RoHS, Industry Canada (IC)
- Wireless accessories available for remote gate, elevator and portable applications

### Models

#### AD-300/301

The AD-300 hardwired networked lock provides instant control of your access control system. Whether you're trying to lock down or unlock one door or every door in the facility, add or remove a user, or simply see the status of the opening—you can be confident that you're doing so in real-time, right from your computer.

- Real-time communication between access control software panel and lock
- AD-301 FIPS 201-1 compliant hardwired lock available for government applications



#### AD-400/401

The AD-400 wireless networked lock gives you all the benefits of a hardwired access control system—without the wires. This allows you to secure doors that were difficult to run wires to in the past, such as historic buildings or sensitive areas, while increasing security throughout the facility.

- Unique communication protocol that won't interfere with other wireless networks
- Patent-pending wireless feature that enables efficient centralized lockdown in less than 10 seconds—while still optimizing battery life up to 2 years
- AD-401 FIPS 201-1 compliant wireless lock available for government applications



#### PIB300-2D: Panel interface board

If access control software panel requires Wiegand or Clock and Data protocol (rather than a direct RS-485 connection,) a PIB300 is required for communication between the AD-300 hardwired lock and the access control panel.

The AD Series platform enables connection of up to two AD-300 locks to the PIB300 (sold separately).



#### Panel interface module

A panel interface module (PIM) provides communication between lock and access control panel for seamless integration with access control system provider modules.

#### PIM400-TD2

Integrates to an access control panel and its reader interface modules via Wiegand or Clock & Data protocols. The PIM400-TD2 can support up to 2 locks depending on the access control software.



#### PIM400-485

Integrates to access control panel via RS-485 eliminating the need for reader interface modules. The PIM400-485 can support up to 16 locks depending on the access control software.



## AD Series - Standalone electronic locks

On all AD Series standalone locks, Schlage has built in many of the incremental features needed in a networked system such as request-to-exit and -enter sensors, interior cover tamper guard, as well as the door position switch. This way, if the customer chooses to network the opening in the future, all the components will be there to make the transition an easy one.

Just like AD-300 and AD-400 networked locks, the AD-200 and AD-250 standalone locks are modular and customizable by design, allowing them to fit the needs of any application now and adapt to meet future needs without removing them from the door.

### Features

- Modular design allows customization and ability to upgrade to a networked wireless solution
- Audit trail reports allow you to track usage and events
- Field configurable fail-safe/fail-secure and other capabilities
- Battery operation eliminates wires to the door making it ideal for sensitive or historic spaces
- Compatible with major brands of master key systems and exit devices
- ANSI/BHMA A156.25, ANSI/BHMA Grade 1, UL 294, UL 10C, FCC Part 15, ADA, RoHS

### Models

#### AD-200

The AD-200 is a simple, economical solution if no access control system currently exists in a facility, or for openings that don't require networked access control. The AD-200 is easily upgradeable to a networked lock by replacing reader and communication module, if requirements change in the future.

- Multi-technology reader options are NFC compatible
- Update users and access rights at the lock using keypad or handheld device



#### AD-250

The AD-250 is a unique solution in which the access rights are stored on a magnetic stripe card rather than the lock. This allows dynamic rights management on the card to minimize at-the-door reprogramming. And, the lock still maintains an audit trail of events at the door, making it a smart and economical solution for campus-like environments with a large number of users and offline openings.

- Compatible with magnetic stripe reader only, with or without keypad
- Rights stored on credential, allowing users and access rights to be updated with credentials instead of having to visit each lock



#### CT5000 offline controller

Designed for applications where the security and convenience of offline electronic access control is desired, but an integrated electronic lock may not be practical. It is an ideal solution for narrow stile aluminum store front applications because it can work with a variety of readers, as well as interface with peripheral devices such as automatic operators, electric strikes and electromagnetic locks.



- Can make updates to users or access rights using Schlage Express software via Handheld Device or manually at opening
- Supports up to 5000 users and 5000 audits
- Supports up to two paralleled Wiegand readers on a single opening
- Programmed using Schlage handheld device (HHD) via USB connection or compatible keypad
- Three form C relay outputs for strike, auxiliary and alarm
- Three inputs that include door position and request-to-exit
- UL294, Canada UL, FCC Part 15, RoHS



## AD Series - more options to choose from

### Chassis Availability

- Cylindrical
- Mortise
- Mortise deadbolt
- Exit Trim

### Exit device compatibility

- Designed to suite with AD Series locksets and Allegion exit devices to ensure facility remains aesthetically consistent
- For retrofit or new construction applications
- Compatible with many Von Duprin, Falcon or and other manufacturers' devices

### Reader modular compatibility

AD-200/300/400

AD-301/  
401



**Multi-technology**  
 • KEYPAD  
 • MIFARE Classic  
 • MIFARE DESFire EV1  
 • NFC  
 • Proximity

**For AD-301/401**  
 FIPS 201-1 Compliant  
 FMK reader available

AD-250



**Multi-technology**  
 • MIFARE Classic  
 • MIFARE DESFire EV1  
 • NFC  
 • Proximity



Magnetic stripe  
insertion  
 • KEYPAD



Magnetic stripe  
insertion



Magnetic stripe  
(Swipe)  
 • KEYPAD



Magnetic stripe  
(Swipe)



Keypad

### Lever/finish styles

Standard cylinders shown, SFIC and FSIC also available.



Sparta

Rhodes

Athens

Tubular

### Warm tone finishes



605  
Bright brass

606  
Satin brass

612  
Satin bronze

643e  
Aged bronze

### Cool tone finishes



619  
Satin nickel

625  
Bright chrome

626  
Satin chrome

626AM  
Satin chrome  
with antimicrobial

## CO Series - Standalone electronic locks

CO Series standalone electronic locks by Schlage provide the security, efficiency and convenience of electronic access control without the cost or complexity of a fully networked system. Compatible with most major brands of key systems, the CO Series is based on the trusted chassis design of Schlage ND & L Series mechanical locks. It leads the industry in independent third party testing and certification ensuring the highest degree of reliability.

### Models

#### CO-100

The CO-100 is a standalone lock that is manually programmable with user rights stored on the lock. Unique PIN codes can be assigned to each user which can be easily added or deleted at any time, right at the door.

- Manually programmable with user rights stored on lock
- Up to 500 unique 3-6 digit PIN codes
- Keypad only
- Classroom/storeroom and office functions available
- ANSI/BHMA A156.25, ANSI/BHMA Grade 1, UL 294, UL 10C, FCC Part 15, ADA, RoHS



#### CO-200

The CO-200 is computer or manually programmable with users rights stored on the lock. The Handheld Device (HHD), used in conjunction with your access control software, allows you to easily add or delete users and retrieve audits.

- Manually or computer programmable via handheld device with user rights stored on lock
- Up to 2000 users and audits
- Keypad, magnetic stripe, and proximity reader options available, as well as proximity + keypad for dual authentication
- Classroom/storeroom, office and privacy functions available
- ANSI/BHMA A156.25, ANSI/BHMA Grade 1, UL 294, UL 10C, FCC Part 15, ADA, RoHS



#### CO-220

The CO-220 classroom lockdown solution allows immediate local lockdown of up to 10 paired locks by simply pushing the remote fob button from up to 75' inside the classroom or up to 25' outside the classroom. The CO-220 is manually or computer programmable, and includes an illuminated visual indicator providing instant verification that the door is secured. Use in conjunction with the HHD to easily manage users and audits on the CO-220.



- Manually or computer programmable via handheld device with user rights stored on lock
- Includes one pre-paired remote lockdown fob
- Up to 2000 users and audits
- Keypad, magnetic stripe, and proximity reader options available, as well as proximity + keypad for dual authentication
- Classroom/storeroom function
- ANSI/BHMA A156.25, ANSI/BHMA Grade 1, UL 294, UL 10C, FCC Part 15, ADA, RoHS

#### CO-250

The CO-250 is a computer programmable offline lock that stores user rights on the magnetic stripe credential, and captures an audit trail in the lock. The CO-250 provides dynamic rights management, allowing you to change user access rights without having to visit the door. This makes it a cost effective solution for offline environments with a large number of users. Use in conjunction with the HHD to easily manage users and audits on the CO-250.



- Computer programmable with user access rights stored on card
- Unlimited number of users
- Up to 4000 audits, depending on access control software
- Magnetic stripe reader (standard) with or without keypad available
- Classroom/storeroom, office and privacy functions available
- ANSI/BHMA A156.25, ANSI/BHMA Grade 1, UL 294, UL 10C, FCC Part 15, ADA, RoHS

### Schlage Utility Software on handheld device

The Schlage Utility Software (SUS) on the handheld device (HHD) used in conjunction with your access control software provides an easy way to manage users, audits and locks for simple access control management.





## CO Series - more options to choose from

### Chassis Availability

- Cylindrical
- Mortise
- Mortise deadbolt
- Exit Trim

### Exit device compatibility

- Designed to suite with CO Series locksets and Allegion exit devices to ensure facility remains aesthetically consistent
- For retrofit or new construction applications
- Compatible with many Von Duprin, Falcon or other manufacturers' devices

### Reader modular compatibility



### Lever/finish styles

Standard cylinders shown, SFIC and FSIC also available.



### Warm tone finishes

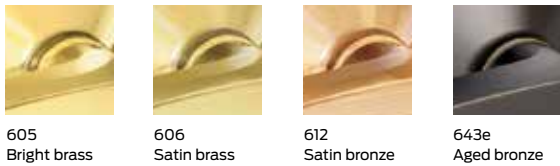

### Cool tone finishes





## Readers and credentials

Allegion's comprehensive portfolio of aptiQ and XceedID readers and credentials not only features cutting-edge security technologies, but provides the versatility and simplicity desired of any electronic access control solution.

### Readers

Allegion's comprehensive reader lineup offers a streamlined portfolio of wall-mount devices designed to meet the access control needs of any facility or business.

aptiQ® readers communicate with most security systems and products and read a variety of card formats, including magnetic stripe, proximity, smart and NFC, offering a complete solution today and an effortless migration path to future technologies.

The simplified line of aptiQ multi-technology readers offers five models suitable for almost any installation. The aptiQ smart reader and XceedID® proximity reader provide ideal options for installations that require one specific technology solution.

- Accommodates interior, exterior, metal and non-metal installation environments
- Wiegand output for simple interface with most access control panels
- Ability to read magnetic stripe, proximity, smart and mobile credentials
- FIPS 201-1 compliant
- Quick-connect design for easy installation
- Easy-to-install mounting bracket



SM10

MT11

MT15

MTK15

MTMS15

MTMSK15

### Credentials

With the latest in contactless smart card and traditional proximity card technologies, Allegion offers a credential solution for every budget and business need.

aptiQ® 13.56 MHz smart cards with MIFARE® Classic and MIFARE DESFire™ EV1 technologies utilize encrypted data, providing an extra layer of security. aptiQ smart credentials also support a variety of applications beyond access control, such as transit, cashless vending and cafeteria point-of-sale.

#### Smart technology:

Using MIFARE DESFire EV1 - This card protects sensitive data by utilizing extra layers of security protection and features the most rapid data transfer in the industry.

Using MIFARE Classic - Ideal for facilities with moderate security needs and for business that want to use credentials to support multiple business functions.

**Proximity technology:** Cost-effective solution for facilities with less demanding security needs

**Multi-technology:** Extremely flexible solution that uses both proximity and smart technology, enabling easy migration from one technology to the other

**Mobile:** aptiQmobile™ takes campus and work life to the next level by providing the convenience of using a smartphone the same way a smart card is used today. This easy-to-use mobile app utilizes NFC (Near Field Communication) technology. Use your phone to access secure buildings and many additional services. Just hold your phone up to an aptiQ reader and you're in.





## Biometrics - hand geometry readers

Biometric products identify people by analyzing their unique human characteristics. Schlage Hand Geometry readers use field-proven technologies to provide increased security at any door and to ensure that the right person is at the right place at the right time. These technologies are frequently used in universities, data centers, day care centers, airports, health care facilities and government buildings.

### Biometrics for access control

Schlage biometrics offers biometric technology as a highly secure alternative to easily lost or compromised ID cards and PIN numbers. Not only are they more secure, but our biometric hand readers are amazingly versatile and can fit the needs of nearly any type of business. They can be used as standalone system to protect critical access points and also can be easily integrated into virtually every new or existing access control system in the market today. Security levels can be customized to be user-specific, as well as time zones, holidays and languages.

### HandKey II

The HK-II is ideal for applications where consistent and dependable security is of prime importance. The product is easy to maintain, and provides an ideal mix of convenience, security and peace of mind.

#### Features & benefits

- Supports of multiple credential options such as proximity, magnetic stripe, barcode, HID Legacy iCLASS® and aptiQmobile™
- Onboard Ethernet with PoE capability
- Field installable WiFi communication module
- Outdoor enclosure options for use in outdoor applications
- Field-upgradeable and expandable memory options from 512 to 206,272 users

#### Applications

- Critical infrastructure including transportation hubs, data centers, construction facilities, government facilities, prisons, military installations
- Healthcare facilities
- Financial institutions
- Education
- Hospitality
- Commercial buildings



## Biometrics - hand geometry readers

### Biometrics for workforce management (time & attendance)

The Schlage GT-400 Series and HandPunch Series terminals utilize the same hand geometry technology in the HandKey II to automate Workforce Management systems, control labor costs, eliminate costly badges and cards, reduce compliance risk and stop time fraud.

#### HandPunch G-Series

The HandPunch G-Series time clock, coupled with your time & attendance software provider, provides daily, tangible benefits such as accurate record keeping, risk mitigation and increased employee productivity.

#### HandPunch F-Series

Our HandPunch F-Series eliminates the time and potential errors associated with manually calculating employee hours. These readers also eliminate costly "buddy punching" because biometrics identify a person based on their unique physical characteristics instead of a card or other credential.



### Enclosure options for outdoor applications

Schlage biometrics provides various options to protect your HandKey II or HandPunch from the elements. Two different, proven solutions are available to ensure your HandKey II keeps performing regardless of your environment.

Part number	FX ENCL	TX ENCL
<b>Temperature range</b>	-20°F to 120°F -29°C to 49°C	-45°F to 120°F -43°C to 49°C
<b>Dimensions H x W x D</b>	14.75" x 12.00" x 10.50" (37.5 cm x 30.5 cm x 26.7 cm)	23.00" x 14.00" x 11.25" (58.5 cm x 35.6 cm x 28.6 cm)
<b>Gross weight</b>	7.3 lbs / (3.3 kg)	45.0 lbs / (20.4 kg)
<b>Handkey models</b>	HK-2-F3	HK-2-F3
<b>Heater</b>	Factory installed option only, model no. INT-HTR	Factory installed option only, model no. INT-HTR





## Electromagnetic locks

Schlage electromagnetic locks are used to secure the door in conjunction with push bars, request-to-exit devices, or credential readers for fail-safe applications when code compliance permits. You can use them on a single standalone door or as part of an access control system. Electromagnetic locks are extremely durable and do not contain moving parts, making them ideal for high security applications.

Electromagnetic locks consist of an armature and coil assembly that becomes magnetized when an electric current passes through them, creating a magnetic field to secure the door. Electromagnetic locks are fail-safe by design. To unlock the door simply remove power.



### M400 Series

The M400 electromagnetic locks are designed to be robust, secure and easy to install. All M400 Series locks are both non-handed and symmetrical, allowing optimum placement of the magnet no matter the application. Available in basic or Plus configurations with intelligent sensing and reporting features.

Models: M420, M450, M490, M490DE

Certifications:

M420/450/490: ANSI/BHMA A156.23, UL 10C, UL 1034, cUL, CSFM  
M490DE: UL special locking arrangements, UL 10C, cUL, CSFM

### 40/70 Series

Common templates and a variety of standard features make 40/70 Series electromagnetic locks ideal for virtually any retrofit application.

Models: 40, 40TJ (tob jamb), 70, 70TJ

Certifications: ANSI/BHMA A156.23, UL 10C, cUL, CSFM

### GF3000 Series

Mortise or surface mounted shear lock options offer a totally concealed locking mechanism providing superior security and a streamlined appearance.

Models: Mortise- GF3000, GF3000TRD (top rail door), GF3000BRD (bottom rail door)  
Surface- GF3000SM, GF3000TJ

Certifications: ANSI/BHMA A156.23, UL 10C, cUL, CSFM

### M390RFK

The M390RFK magnetic lock is designed to retrofit the Locknetics 390+ without any additional prep, ensuring ease of installation for retrofit applications. The M390RFK includes a door position switch (DPS), magnetic bond sensor (MBS), and relocking time delay (RTD). All models easily interface with most electronic access control systems in the market today, as well as automatic door operators and fire or other hazard sensing systems for egress and emergency egress

Model: M390RFK

Certifications: UL 10C, cUL

### 320M

The 320M mortise mounted electromagnetic lock is designed for use on sliding doors and interfaces with electronic access control systems, automatic door operators, and fire or hazard sensing systems to provide egress upon detectable emergency. With no moving parts and a fail-safe design, it offers an excellent solution for both security and life safety requirements when connected to the fire alarm circuit.

Model: 320M

Certifications: Meets ANSI/BHMA A156.23, UL 10C, cUL, CSFM

### M490G

The M490G is a weather resistant high security electromagnetic lock with 1500 lbs. of holding force designed for use on all types of sliding and swinging gates.

Model: M490G

**Certifications:** ANSI/BHMA A156.23 for outdoor use

Model	Application	Holding force	Magnetic bond sensor	Door position switch	Relock time delay	Double door configuration
M420	Traffic control	500 lb.	*	*	*	Optional
M450	High security	1000 lb.	*	*	*	Optional
M490	Max security	1500 lb.	*	*	*	Optional
M490DE	Delayed egress	1500 lb.	*	*	*	Optional
M490G	Exterior gate	1500 lb.	■	■	-	-
M390RFK	Locknetics 390+ replacement	1500 lb.	■	■	■	-
<b>Specialty locks</b>						
GF3000SM	Shear lock outswinging door	3000 lb.	Optional	Optional	■	-
GF3000TJ	Shear lock inswinging door	3000 lb.	Optional	Optional	■	-
320M	Sliding door	500 lb.	■	■	■	-
40	Traffic control	500 lb.	-	-	-	-
70	High security	1000 lb.	-	-	-	Optional

\*Only available on Plus (P) model

## Power supplies

The PS900 Series incorporates Schlage and Von Duprin power supplies to cover a range of power needs for virtually any electronic access control application. Available accessories include five distribution boards, a fire alarm board and a battery backup board to offer enhanced flexibility and functionality. The complete line of UL 294, ULC-S318, RoHS, and FCC Part 15 certified power supplies meets the industry standard for reliability and performance.

The PS900 Series can be used in a variety of applications to convert high voltage AC power into the low voltage DC outputs required by most access control devices. PS900 Series power supplies protect devices downstream by providing ultra steady low voltage, regulated and filtered DC. Distribution board options allow for basic fuse protection, simple relay and advanced logic providing complex sequencing and timing functions.



### Models

#### Schlage PS902

- 2 Amps at 12/24 VDC output
- Single polarized option board connector
- Fire alarm relay connection on main or option board
- Class 2 rated power limited output

#### Schlage PS906

- 6 Amps at 12/24 VDC output
- Three polarized option board connectors
- Fire alarm relay connection requires option board
- Can provide class 2 rated outputs when used with 900-8P distribution board

#### Schlage PS904

- 4 Amps at 12/24 VDC output
- Two polarized option board connectors
- Fire alarm relay connection requires option board
- Class 2 rated power limited output

#### Von Duprin PS914

- Designed for high in-rush to use with delayed egress or electric latch panic devices
- 4 Amps at 12/24 VDC output
- Two polarized option board connectors
- Fire alarm relay connection requires option board
- Class 2 rated power limited output



### Option boards

A variety of option boards are available to meet all access control needs:

- 900-4R\* - Independently controlled relays to power multiple devices
- 900-2RS\* - 2 relay EL panic device control board
- 900-4RL\* - 4 relay board with integrated logic for controlling security interlocks
- 900-8F\* - 8 individually fuse protected outputs, giving the flexibility to power multiple devices
- 900-8P\* - 8 PTC protected outputs
- 900-FA - Emergency interface relay integrates with fire alarm (main board connection on PS902, requires available option board for connection on other models)
- 900-BB - Battery backup board (main board connection on all models)

\*Indicates that fire alarm relay can be added to these boards.



## Electronic system accessories

Schlage's broad portfolio of system accessories allows you to customize each unique opening to meet specific security and safety concerns. System accessories include a variety of devices that enable specific functionality whether in standalone applications or as part of networked access control systems. System accessories are commonly used in conjunction with wall mounted readers as part of a traditional hardwired access control system.

We offer a variety of system accessories that include: pushbuttons, key switches, request to exit bars, monitoring stations & consoles, exit sensors, electric horns and more. Our products easily integrate together to help reduce the complexity of securing a facility.

### Keyswitches

#### 650 Series keyswitches

A switch that can only be activated by a key. Single gang and narrow stile options with wall plates available in six finishes.

### Pushbuttons

#### 620/631 Series pushbutton

A pushbutton designed for heavy-duty applications. Used to control the ingress and/or egress of a door. Wall plates available in six finishes.

#### 700 Series pushbutton

A pushbutton designed for standard-duty for commercial applications. Used to control the ingress and/or egress of a door.

#### 740 Series emergency break glass release

Designed for use as an emergency release of non-designated egress doors.

#### 660 Series mini station control

Designed for concealed desk application and is used to release an electric or electronic locking mechanism from a remote location.

### Request-to-exit bars

#### 672 Series TouchBar

A request to exit device that releases electromagnetic or electronic locks when bar is depressed.

- Heavy-duty aluminum extruded bar
- SPDT monitoring switch, DPDT switch optional
- Available in standard lengths for 36", 42" and 48" doors
- Models 672 and 692 are field reversible

#### 692 Series SmartBar™

An electronic switching device which serves as a non-latching request to exit bar. Touching the SmartBar at any point on the bar activates internal circuitry which controls power to the locking device.

- Breaking either of the two redundant and directionally opposed infrared beams activates the relay
- DPDT relay

### Motion detectors

#### Scan II™ passive infrared motion sensor

A motion sensor that provides passive infrared motion sensors specifically designed for "request-to-exit" applications.

### Other accessories

#### 800 Series monitoring stations

A remote and local monitoring station that provides monitoring for a single zone with up to 2 LED indicators.

#### 8200 Series consoles

A monitoring console that provides door control and monitoring for up to eight zones.

#### PB405/PB405S electrified deadbolts

Electrified deadbolt with a mortise, right angle deadbolt with a .61" x.67" throw. Available in fail-safe (PB405) or fail-secure (PB405S)

#### 1910 Series electronic horn

Designed for use as an immediate local audible warning device incorporated into a security system.

#### 7764 / 7766 Series door position switch

Door position switch used to detect the open or closed status of an opening and send the status to a control panel. Concealed and surface mounted designs available.

#### 788 / 798 Series armored door cord

Provides a simple and economical solution for transferring power from frame to door.



650 Series keyswitches



620 Series pushbuttons



620 Series pushbuttons



672 TouchBar

## Warranties

We stand behind the products we make.



### Schlage warranties are some of the best in the business

From our networked electronic locks to commercial locks and levers, residential locks and handlesets, and even portable security, Schlage backs every product we sell with a warranty you can depend on.

Please see your current Schlage price book for warranty details.

### Safety, security and confidence

When you choose a Schlage product you can be sure you've done the job right the first time. After all, our products are among the most durable and dependable on the market today. Our locks are easy to install, and simple to repair and maintain. That means fewer callbacks for you and total security for your customers.

For warranty service and shipping instructions contact:

#### Schlage commercial customers

Schlage Electronics

#### Placing orders

Order\_Entry\_Schlage\_Commercial@allegion.com

#### Technical support:

Electronic\_Lock\_TechProdSupport@allegion.com

#### Paying invoices:

Schlage Electronic Security  
15934 Collections Center Drive  
Chicago, IL 60693

#### Customer care:

877-671-7011

#### Schlage residential customers

Schlage

Customer Care  
1010 West Santa Fe  
Olathe, KS 66051-1210

(800) 847-1864, Option 1  
(888) 805-9837 Consumers  
Fax (800) 366-LOCK (6525)

The Schlage Lock Company reserves the right to make changes in designs, specifications and warranty coverage, or to make additions or improvements to its products without notice and without incurring any obligation to incorporate them on products previously manufactured. The Schlage Lock Company is not responsible for any modification, addition or to our products by others.

Mechanical

## Contents

### Schlage

Mechanical lock guide

L Series

Vandlgard® and electrified

ND Series

D Series

B Series

AL Series

A Series

H Series

S Series

S200 Series

CS210 Series

Finishes

Commercial grade portable security

Cabinet locks

Key systems

Accessories and service

Lock functions







### Commercial mechanical security

Schlage built its legacy on the strength and innovation of its commercial mechanical security products. Our broad line of mechanical access control systems ranges from vandal- and break-in-resistant door hardware to ADA compliant levers, high security key systems and portable security products. Many of our commercial lines also can be suited to provide the style you need across the varying needs of commercial buildings.



Schlage commercial locks



Tubular interconnected locks



Tubular locks

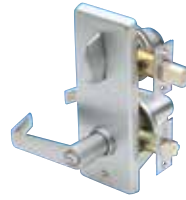

Tubular interconnected locks







Cylindrical locks



Cylindrical interconnected locks

CS200 Series	S Series	S200 Series	A Series	H Series
Grade 2	Grade 2		Grade 2	
Security level:				
ANSI/BHMA certified A156.2-2013 Exceeds 400,000 ANSI cycles Medium traffic	ANSI/BHMA certified A156.2-2011 Exceeds 400,000 ANSI cycles Light traffic	- - Exceeds 400,000 ANSI cycles Medium traffic	ANSI/BHMA certified A156.2-2011 Exceeds 400,000 ANSI cycles Medium traffic	- - Exceeds 400,000 ANSI cycles Medium traffic
Typical applications:				
Exterior Interior New construction Retrofit	- Interior - Retrofit	Exterior Interior New construction Retrofit	Exterior Interior New construction Retrofit	Exterior Interior - Retrofit
Functions available:				
1 Function - -	6 Functions - -	5 Functions - -	11 Functions - -	5 Functions - -
Design options:				
6 Finishes 15 Lever styles - 1 Matching rose 2 Interior escutcheons Tactile warning available	7 Finishes 4 Lever styles - 1 Matching rose - Tactile warning available	7 Finishes 4 Lever styles - 1 Matching rose 1 Interior escutcheon -	10 Finishes 1 Lever style 4 Knob styles 1 Matching rose - -	7 Finishes 1 Lever style 2 Knob styles 1 Matching rose 1 Interior escutcheon -
Often used in:				
Commercial Multi-family Office	Commercial Multi-family Office	Commercial Multi-family Office	Commercial Govt/military Healthcare Hospitality Office Retail	Commercial Govt/military Multi-family

Not all functions and finishes available with all products. Please consult your SSC representative for details.

				
Cylindrical locks	Deadbolts	Cylindrical locks	Cylindrical locks	Mortise locks
AL Series	B Series	D Series	ND Series	L Series
Grade 2	Grade 2	Grade 1	Grade 1	Grade 1
<b>Security level:</b>				
ANSI/BHMA certified A156.2-2011 Exceeds 400,000 ANSI cycles Medium traffic	ANSI/BHMA certified A156.5-2010 Exceeds 150,000/250,000 ANSI cycles High traffic, heavy-duty	ANSI/BHMA certified A156.2-2011 Exceeds 1,000,000 ANSI cycles High traffic	ANSI/BHMA certified A156.2-2011 Exceeds 1,000,000 ANSI cycles Heavy-duty traffic	ANSI/BHMA certified A156.13-2012 Exceeds 1,000,000 ANSI cycles Heavy-duty traffic
<b>Typical applications:</b>				
Exterior Interior New construction Retrofit	Exterior - New construction Retrofit	Exterior Interior - Retrofit	Exterior Interior New construction Retrofit	Exterior Interior New construction Retrofit
<b>Functions available:</b>				
10 Functions - -	7 Functions - -	6 Functions - -	14 Functions 2 Electrified -	29 Functions 6 Electrified Vandgard® available
<b>Design options:</b>				
10 Finishes 4 Lever styles - 1 Matching rose - Tactile warning available	10 Finishes - - - - Indicator rose	10 Finishes - 3 Knob styles 1 Matching rose - -	9 Finishes 5 Lever styles - 2 Matching roses - Tactile warning available	13 Finishes 31 Lever style 3 Knob styles 5 Matching roses 2 Escutcheons Tactile warning available Antiligature available
<b>Often used in:</b>				
Commercial Healthcare Hospitality Office Retail	Commercial/institutional Govt/military Heavy-duty residential Hospitality Office Retail	Institutional Govt/military Hospitality Retail	Institutional Education Healthcare Office Retail	Commercial/institutional Govt/military Education Healthcare Office Retail

This chart shows the most common uses/applications. These products are often used in other applications in addition to those listed.



## L Series Grade 1 mortise locks

### L9000 mortise lock

#### Standard features

- The most durable lock we sell
- Highly versatile, easily convertible functions
- Fully wrapped heavy-gauge steel case protects against door edge attacks.
- Hub blocking plate protects lock against spindle manipulation
- No exposed trim mount screws
- Universal lock case available - ten functions in one case
- Optional sleek, contemporary lever line available
- Electrified options on page 41



#### Specifications

<b>Certifications</b>	Exceeds ANSI/BHMA certified A156.13 - 2012, Series 1000, Grade 1 operational, Grade 1 security, UL Listed for 3-hour fire door.
<b>Applications</b>	Heavy-duty traffic, Grade 1 commercial exterior, interior, new construction and retrofit applications. Often used in institutional, education, healthcare and office buildings.
<b>Cylinders</b>	Solid brass 6-pin cylinder in a stainless steel front and back housing Everest keyway standard. Patented Primus XP high security cylinders. Interchangeable cores available in FSIC and SFIC. Two nickel silver cut keys per lock. Master keying, grand master keying, and construction keying available.
<b>Deadbolt</b>	1" (25mm) stainless steel throw.
<b>Standard strike</b>	1 1/4" x 4 7/8" (32mm x 124mm), square corner, 1 3/16" (30mm) lip, box.

#### Finishes

Series	605 US3	606 US4	609 US5	612 US10	613 US10B	619 US15	625 US26	626* US26D	629 US32	630 US32D	643e
03, 06, 07, 12, 17	▪	▪	▪	▪	▪	▪	▪	▪	▪	▪	▪
01, 02, 05 and 18	▪	▪	▪	▪	▪	▪	▪	▪	▪	▪	▪
Asti/Merano, Accent	▪					▪	▪	▪			▪
Latitude/longitude	▪	▪	▪			▪	▪	▪	▪	▪	▪
Omega	▪	▪	▪	▪	▪	▪	▪	▪	▪	▪	▪
41 and 42 knob	▪	▪	▪	▪	▪	▪	▪	▪	▪	▪	▪

Complete finish chart on page 52

\*Antimicrobial coating available; use suffix AM

### L Series small case mortise deadbolt

#### Standard features

- High-strength steel alloy cylinder retainer
- Steel case and parts are corrosion resistant
- Armored front adjustable for door bevel.



L460

#### Specifications

<b>Certifications</b>	Exceeds ANSI/BHMA certified A156.36-2010, Grade 1, UL Listed for 3-hour fire door.
<b>Applications</b>	Deadbolts are designed for use as primary locks where no latching is required, such as restrooms and small doors to utility spaces. They also offer optimum security when used as auxiliary locks in other applications.
<b>Cylinders</b>	Solid brass 6-pin cylinder in a stainless steel front and back housing, Everest™ 29 S123 keyway standard. Patented Primus® XP high security cylinders. Interchangeable cores available in FSIC and SFIC. Two nickel silver cut keys per lock. Master keying, grand master keying, and construction keying available.
<b>Deadbolt</b>	1" (25mm) stainless steel throw.
<b>Standard strike</b>	1 1/8" x 3 5/8" (29mm x 92mm), square corner, box.

#### Finishes

605 US3	606 US4	609 US5	612 US10	613 US10B	619 US15	625 US26	626* US26D	629 US32	630 US32D	643e
▪	▪	▪	▪	▪	▪	▪	▪	▪	▪	▪

Complete finish chart on page 52

\*Antimicrobial coating available; use suffix AM

#### Available on L Series mortise locks



= Antimicrobial coating available on select finishes



= Helps meet LEED certification



= Electrified functions available



= BHMA certified



= Heavy-duty traffic applications



= Complies with ADA accessibility guidelines

**Vandlgard®** = Anti-vandalism protection

## L Series Grade 1 mortise locks

### Mortise lock construction

#### Strength and durability

- Fully wrapped heavy-gauge steel case protects against door edge attacks
- All metal zinc dichromate plated working parts
- Inside lock case protects electronic components
- Two-piece anti-friction tongue reduces wear and tear
- Outside and inside trim through-bolted together and through the door

#### Security built in

- Break-away spindle prevents unsecured failures and provides easy spindle replacement
- Hub blocking plate protects lock against spindle manipulation
- Spring-loaded fusible link provides fail-secure mode in case of fire
- Inside lever applied by screwless shank mounting – no exposed trim mount screws

#### Adaptable to your application

- Universal lock case – ten functions in one case
- Floating mounting tabs automatically adjust to fit a beveled door edge
- Field-reversible handing without opening lock case
- External spring cages allow for simple trim retrofit
- Locking thumbturn on the inside of door visually shows when the door is locked and unlocked
- Lever rotation in both directions (up and down) for ease of use
- Independent lever rotation

#### Fast, easy lock-hand changing

Only Schlage mortise locks can be rehanded with no need to open the lock case. Simply rotate the latch 180° and change the catch screw position.

##### A. Change latchbolt handing

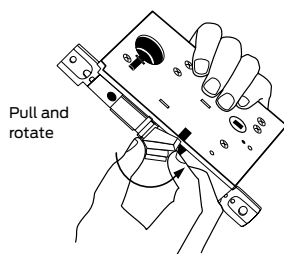

##### B. Change chassis handing

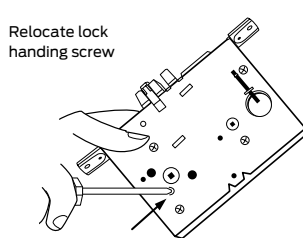

## Antimicrobial coated hardware.

High traffic environments like schools, hospitals and public/government buildings are ideal for antimicrobial hardware. Allegion offers a range of door hardware with a specially formulated antimicrobial coating that inhibits the growth of bacteria by interrupting cell multiplication. That means fewer germs can survive on the hardware's surface. Products available with an antimicrobial coating include:

- Von Duprin exit devices
- Schlage locks and biometric readers
- Ives door accessories
- Glynn-Johnson push/pull levers

EXPERT TIPS

Look for this symbol throughout our catalog to identify those products available with antimicrobial coating.

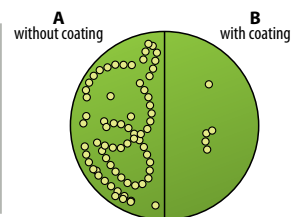

# L Series Grade 1 mortise locks

## Standard lever design options

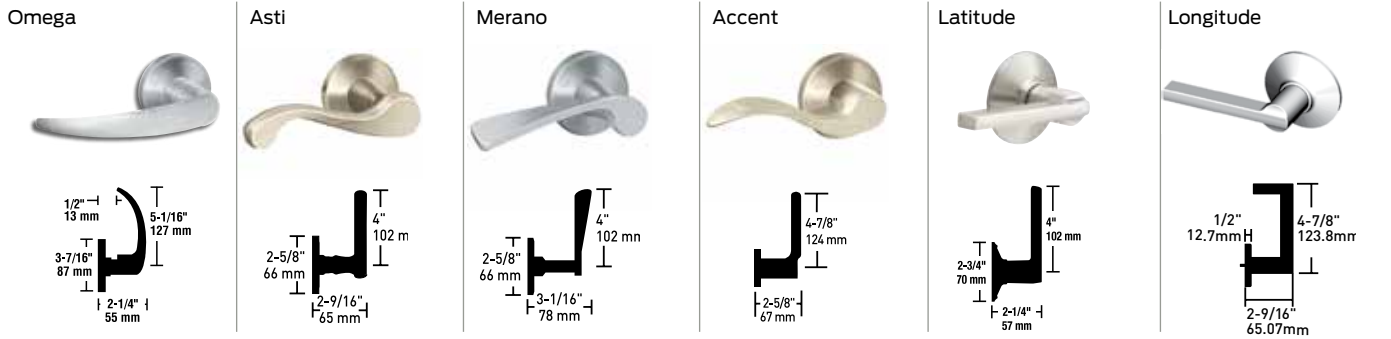
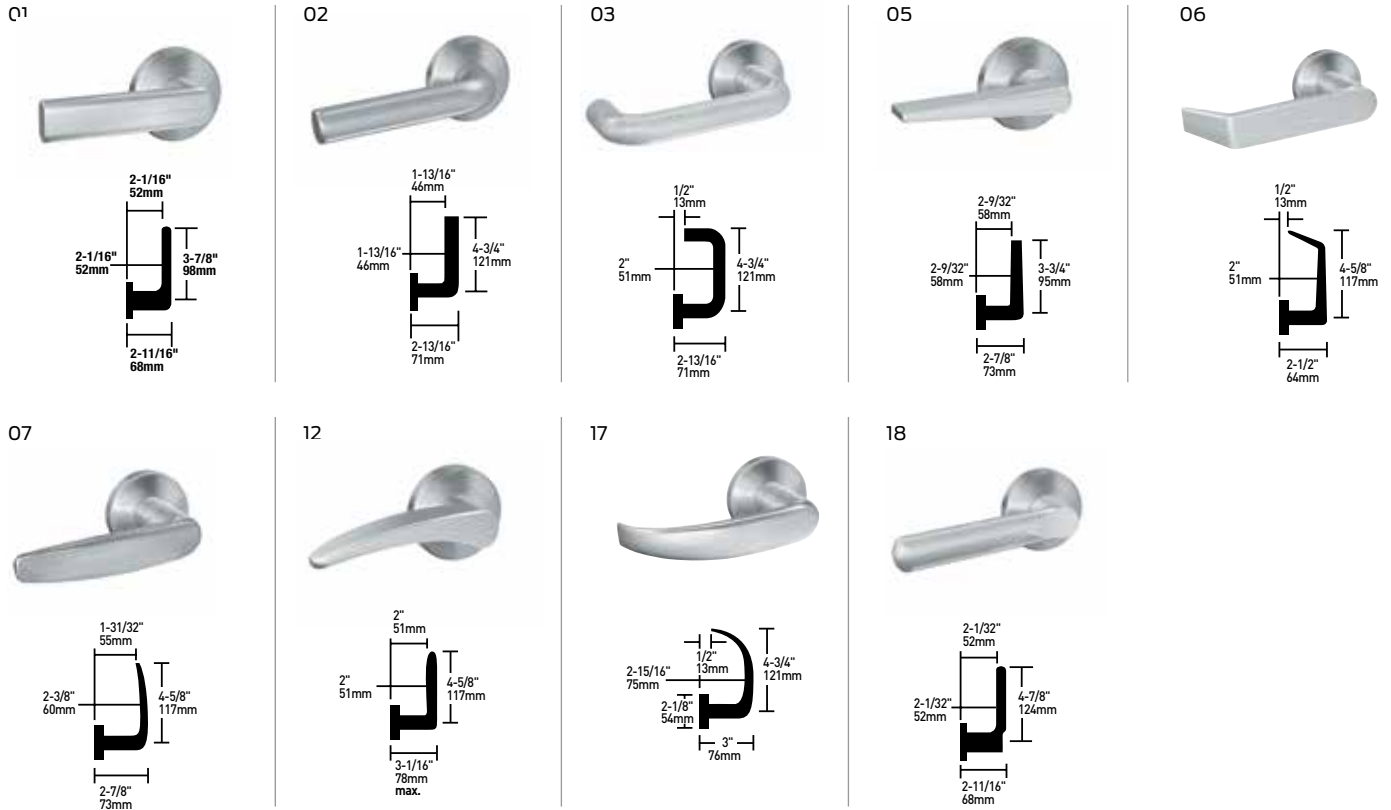



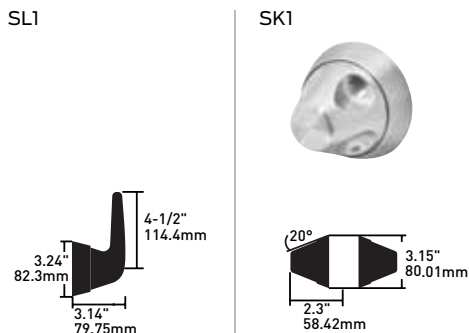







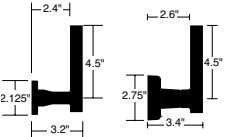

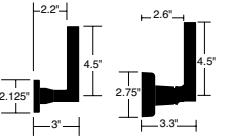

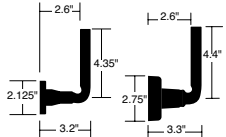

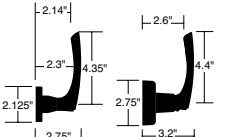

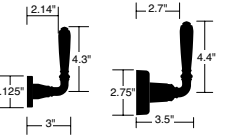

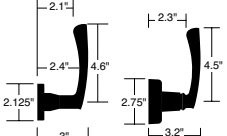

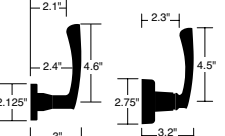

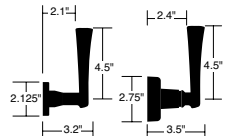

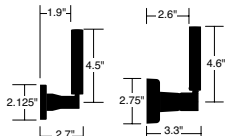

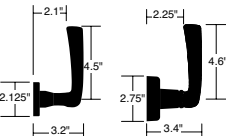
## Anti-ligature

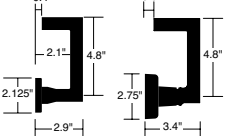

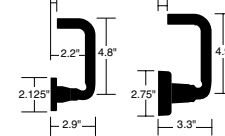
Many L Series levers shown can be suited with Von Duprin exit devices and Schlage residential locks. Call your Allegion representative for details.

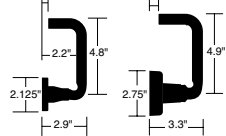
# L Series Grade 1 mortise locks

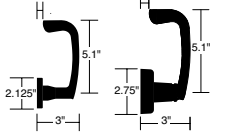
## M Collection lever design options

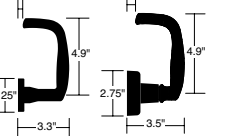
<p><b>M51</b> Knurling available</p>   <p><b>SCHLAGE</b>    <b>VON DUPRIN</b></p>	<p><b>M52</b> Knurling available</p>   <p><b>SCHLAGE</b>    <b>VON DUPRIN</b></p>	<p><b>M53</b></p>   <p><b>SCHLAGE</b>    <b>VON DUPRIN</b></p>	<p><b>M54</b></p>   <p><b>SCHLAGE</b>    <b>VON DUPRIN</b></p>	<p><b>M55</b></p>   <p><b>SCHLAGE</b>    <b>VON DUPRIN</b></p>
<p><b>M56</b></p>   <p><b>SCHLAGE</b>    <b>VON DUPRIN</b></p>	<p><b>M57 ..</b></p>   <p><b>SCHLAGE</b>    <b>VON DUPRIN</b></p>	<p><b>M61</b> (Handed)</p>   <p><b>SCHLAGE</b>    <b>VON DUPRIN</b></p>	<p><b>M62 ..</b> (Handed)</p>   <p><b>SCHLAGE</b>    <b>VON DUPRIN</b></p>	<p><b>M63</b> (Handed)</p>   <p><b>SCHLAGE</b>    <b>VON DUPRIN</b></p>
<p><b>M81</b> Knurling available</p>   <p><b>SCHLAGE</b>    <b>VON DUPRIN</b></p>	<p><b>M82</b></p>   <p><b>SCHLAGE</b>    <b>VON DUPRIN</b></p>	<p><b>M83</b></p>   <p><b>SCHLAGE</b>    <b>VON DUPRIN</b></p>	<p><b>M84</b></p>   <p><b>SCHLAGE</b>    <b>VON DUPRIN</b></p>	<p><b>M85</b> (Handed)</p>   <p><b>SCHLAGE</b>    <b>VON DUPRIN</b></p>

.. Available in stainless steel substrate only.



## L Series Grade 1 mortise locks

### Trim design options

Standard mortise cylinder

L escutcheon standard cylinder

L escutcheon concealed cylinder

N escutcheon standard cylinder



7<sup>15</sup>/<sub>16</sub>" x 1<sup>3</sup>/<sub>4</sub>" x 7<sup>7</sup>/<sub>16</sub>"  
(202mm x 44mm x 11mm)



7<sup>15</sup>/<sub>16</sub>" x 1<sup>3</sup>/<sub>4</sub>" x 7<sup>7</sup>/<sub>16</sub>"  
(202mm x 44mm x 11mm)



7<sup>7</sup>/<sub>8</sub>" x 2<sup>1</sup>/<sub>2</sub>" x 7<sup>7</sup>/<sub>16</sub>"  
(200mm x 64mm x 11mm)

L Series mortise locks meet all requirements for installation in doors and frames prepared in accordance with ANSI 115.1.



### L583-363 "EZ" thumbturn

Disability turn (ADA) option to standard thumbturn. Can be used with any thumbturn function L Series lock, except L9463 and L463.

### 180 degree Indicators

All-new design available for Sectional or N-Escutcheon trim. Available with new locks or as retrofits for existing Schlage L-series locks. See "expert tips" on this page for more details.



### SK1 antiligature knob and SL1 antiligature lever

For use in healthcare and detention facilities and available in a wide variety of functions. Includes antiligature thumbturn or cylinder ring as appropriate with function.

## Visual indicators.

Several Allegion brands have products equipped with visual indicators. This innovative feature immediately alerts a user about a door's locked or unlocked status.

In many applications, particularly in K-12 and higher education, indicators are part of the overall security plan. With indicators on locks or exit devices, an opening can be quickly assessed—from a distance—to determine if it is locked. The convenience of using at-a-glance indicators to assess a lock saves time and alleviates confusion in the event of an emergency.

### Schlage L Series indicator

- 2" x 1/2" display with 180 degree windows and high-mount design for easy visibility from anywhere in the room
- Available for use on either the inside or outside of door; supports cylinder, thumbturn, cointurn or privacy functions.
- Four available messages - LOCKED/UNLOCKED, OCCUPIED/VACANT, DO NOT DISTURB/blank, or symbols only
- For sectional or N-escutcheon trim
- Available as a new product or as a retrofit to an existing L-Series mortise lock

EXPERT TIPS



## Vandlgard® and electrified locks featured on L Series and ND Series

### Vandlgard

Schlage L Series and ND Series locks with Vandlgard provide exceptional vandal-resistant performance designed for maximum accessibility, security and durability in heavy-duty traffic applications subject to abuse. The unique features of Vandlgard prevent damage to internal lock components caused by excessive force from persons kicking, hitting or standing on the lever to gain access. Vandlgard functions maintain total architectural design and key system compatibility with your Schlage commercial locks.

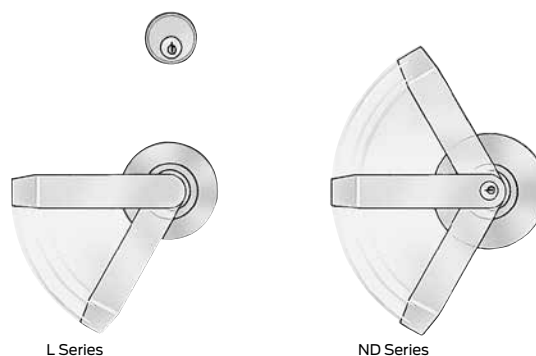

The locked lever freely rotates while remaining securely locked. The Vandlgard function also increases resistance to over-rotation of the lever.

### Electrified locks

Schlage L Series and ND Series locks make a great choice for electrified openings. They offer the ultimate in toughness, style and installation flexibility for a wide range of applications.

#### L Series electrified locks

L Series locks are available for electrically locking and unlocking in high security and fire safety applications. They are UL/cUL Listed and rated for both fire and single point locking on labeled doors. Refer to the lock function pages for function availability.

Request-to-exit and latch monitoring available on select functions.

#### Electrical requirements

##### Voltage:

Autodetects 12 or 24V DC  
(minimum 10.8V, maximum 26.4V)

##### Peak current:

0.4 amps

##### Holding current:

0.01 amps

##### Operating temperature:

Maximum +140°F (+60°C)  
Minimum -22°F (-30°C)

All installations should be in accordance with local electrical codes.



#### ND Series electrified locks

ND Series locks are available for electrically locking and unlocking controls for high security and fire safety applications. They are UL Listed and rated for both fire and electrical single-point locking on labeled doors. Refer to the lock function pages 65-68 for function and design availability.

Request-to-exit available on select functions. The factory installed switch is wired for both normally open or normally closed configuration requirements.

#### Electrical requirements

##### Voltage:

Autodetects 12 through 24V DC

##### Peak current:

0.23 amps (230mA)

##### Holding current:

**0.01 amps (10mA)**

##### Operating temperature:

Maximum +120°F (+49°C)  
Minimum +32°F (0°C)

All installations should be in accordance with local electrical codes.





# ND Series Grade 1 cylindrical locks

## Lever design options

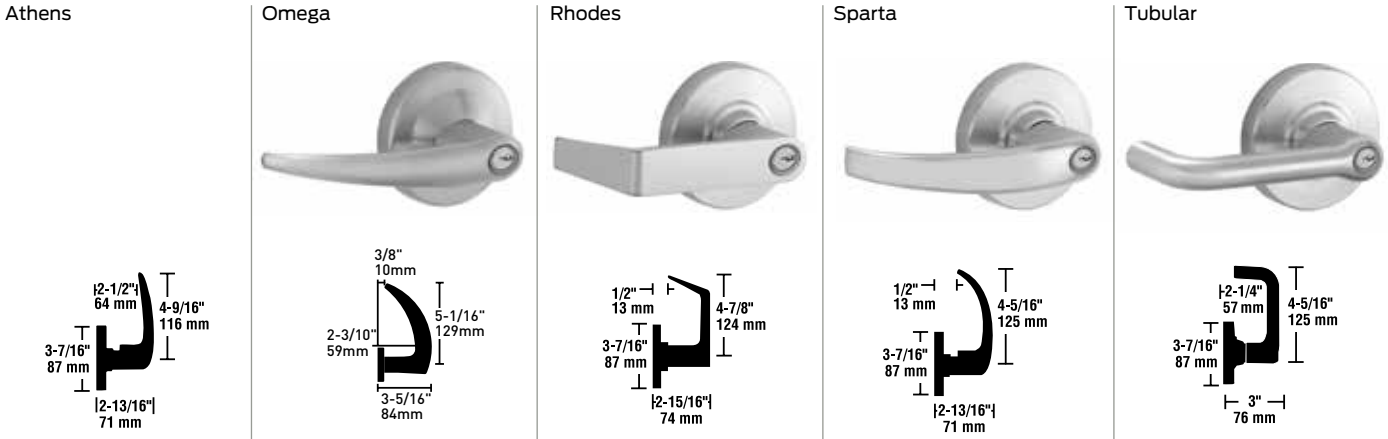

### Standard features

- Through-bolted mechanism for positive interlock to door
- Concealed mounting screws
- Independent heavy-duty spring cages for effective lever support
- All ND Series lever locksets are non-handed
- Electrified options on page 41

### Finishes

Levers	605 US3	606 US4	612 US10	613 US10B	619 US15	625 US26	626 US26D	643e	626
Athens	▪	▪	▪	▪	▪	▪	▪	▪	▪
Omega	▪	▪	▪	▪	▪	▪	▪	▪	▪
Rhodes	▪	▪	▪	▪	▪	▪	▪	▪	▪
Sparta	▪	▪	▪	▪	▪	▪	▪	▪	▪
Tubular	▪	▪	▪	▪	▪	▪	▪	▪	▪

Complete finish chart on page 52

### Specifications

<b>Certifications</b>	Exceeds ANSI/BHMA certified A156.2-2011, Series 4000, Grade 1, UL Listed for 3-hour fire door.
<b>Applications</b>	Heavy-duty traffic, Grade 1 commercial exterior, interior, new construction and retrofit applications. Often used in institutional, education, healthcare, office and retail buildings.
<b>Cylinders</b>	Solid brass 6-pin cylinder, Everest 29 S123 standard. Patented Primus XP high security cylinders. Interchangeable cores available on select styles. Two nickel silver cut keys per lock. Master keying, grand master keying, and construction keying available.
<b>Standard latch</b>	1 1/8" x 2 1/4" (29mm x 57mm, square corner faceplate, 1" (25mm) housing diameter, 1/2" (13mm) throw.
<b>Standard strike</b>	1 1/4" x 4 7/8" (32mm x 124mm), ANSI, square corner, no box.

## Visual indicators

Several Allegion brands have products equipped with visual indicators. This innovative feature immediately alerts a user about a door's locked or unlocked status.

In many applications, particularly in K-12 and higher education, indicators are part of the overall security plan. With indicators on locks or exit devices, an opening can be quickly assessed—from a distance—to determine if it is locked. The convenience of using at-a-glance indicators to assess a lock saves time and alleviates confusion in the event of an emergency.

### Schlage ND Series indicator

- Clear direction on the inside of the lock on how to safely and quickly secure a room
- Available as a new product or retrofit to an existing ND Series lock

EXPERT TIPS

### Available on ND Series

= Antimicrobial coating available on select finishes	= Electrified functions available	= Heavy-duty traffic applications	= Anti-vandalism protection
= Helps meet LEED certification	= Safe school locks on select functions	= Complies with ADA accessibility guidelines	= BHMA certified

# D Series Grade 1 cylindrical locks

## Knob design options

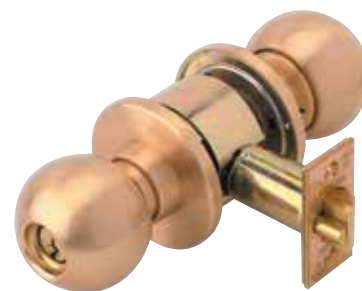

Orbit

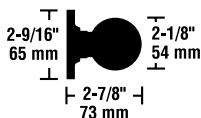

Plymouth

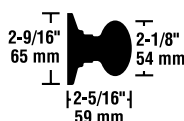

Tulip

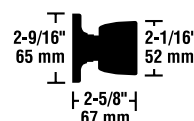

### Standard features

- Long life and smooth action with roller bearings and coil compression springs on latch retractors
- Corrosion resistant lock chassis using steel and zinc dichromate plating
- Concealed mounting screws

### Finishes

Knobs	605	606	609	612	613	619	625	626	629	630	643e
	US3	US4	US5	US10	US10B	US15	US26	US26D	US32	US32D	
Orbit	▪	▪		▪	▪		▪	▪	▪	▪	▪
Plymouth	▪	▪		▪	▪		▪	▪	▪	▪	▪
Tulip	▪	▪		▪	▪		▪	▪			▪

Complete finish chart on page 52

### Specifications

<b>Certifications</b>	Exceeds ANSI/BHMA certified A156.2-2011, Series 4000, Grade 1, UL Listed for 3-hour fire door.
<b>Applications</b>	High traffic, Grade 1 commercial exterior, interior and retrofit applications. Often used in institutional, government/military, hospitality and retail buildings.
<b>Cylinders</b>	Solid brass 6-pin cylinder, Everest 29 S123 keyway standard. Patented Primus XP high security cylinders. Interchangeable cores available on select styles. Two nickel silver cut keys per lock. Master keying, grand master keying, and construction keying available.
<b>Standard latch</b>	1 1/8" x 2 1/4" (29mm x 57mm), square corner faceplate, 1" (25mm) housing diameter, 1/2" (13mm) throw.
<b>Standard strike</b>	1 1/4" x 4 7/8" (32mm x 124mm), ANSI, square corner, no box.

### Available on D Series

= High traffic applications
 = Helps meet LEED certification
 = Complies with ADA accessibility guidelines
 = BHMA certified





## B Series Grade 1 and 2 commercial deadbolts

### B600, B700, B800 Series Grade 1 commercial



Shown: B660P single cylinder

B660G single cylinder

#### Standard features

- Highest grade deadbolt locks
- Heavy-duty performance - solid rotating trim rings
- Hardened steel balls protect mounting bolts from drill attack
- Available in single and double cylinder†

#### Specifications

<b>Certifications</b>	Exceeds ANSI/BHMA certified A156.36-2010, Grade 1, UL Listed for 3-hour fire door.
<b>Applications</b>	Heavy-duty traffic, Grade 1 commercial exterior, new construction and retrofit applications. Often used in commercial/institutional, government/military, heavy-duty residential, hospitality, office and retail buildings.
<b>Cylinders</b>	Solid brass 6-pin cylinder, Everest 29 S123 keyway standard. Patented Primus XP high security cylinders Interchangeable cores available in SFIC and FSIC for all cylinder functions. Two nickel silver cut keys per lock. Master keying, grand master keying, and construction keying available.
<b>Deadbolt</b>	1 1/8" x 2 1/4" (29mm x 57mm), square corner faceplate, 1" (25mm) housing diameter, 1" (25mm) throw.
<b>Standard strike</b>	1 1/8" x 2 3/4" (29mm x 70mm), square corner.

#### Available on B600, B700 and B800 Series

- = Antimicrobial coating available on select finishes
- = Heavy-duty traffic applications
- = Helps meet LEED certification
- = Complies with ADA accessibility guidelines
- = BHMA certified

### B500 Series Grade 2 commercial



Shown: B560P single cylinder

#### Standard features

- Higher security - 10% larger diameter deadbolt
- Tougher performance - seamless steel construction from beginning of latch to back of bolt
- Installation versatility - adjustable backset with lock-in-place helix design
- Available in single and double cylinder†

#### Specifications

<b>Certifications</b>	Exceeds ANSI/BHMA certified A156.36-2010, Series 4000, Grade 2, optional UL Listed for 3-hour fire door (except B562 and B571).
<b>Applications</b>	High traffic, Grade 2 commercial exterior, new construction and retrofit applications. Often used in commercial/institutional, government/military, heavy-duty residential, hospitality, office and retail buildings.
<b>Cylinders</b>	Solid brass 6-pin cylinder, Everest 29 S123 keyway standard. Patented Primus XP high security cylinders available. Two nickel silver cut keys per lock. Master keying and construction keying available.
<b>Deadbolt</b>	1" x 2 1/4" (25mm x 57mm), square corner faceplate, 1" (25mm) housing diameter, 1" (25mm) throw.
<b>Standard strike</b>	1 1/8" x 2 3/4" (29mm x 70mm), square corner, box.

#### Available on B500 Series

- = Antimicrobial coating available on select finishes
- = High traffic applications
- = Helps meet LEED certification
- = Complies with ADA accessibility guidelines
- = BHMA certified

†Caution: Double cylinder locks on residences and any door in any structure which is used for egress are a safety hazard in times of emergency and their use is not recommended. Installation should be in accordance with existing codes only.

## B Series Grade 2 commercial deadbolts

### B250 Series

#### Grade 2 commercial



Shown: B250PD deadlatch

#### Standard features

- Ideally suited for pool, condominium gates, and utility panels
- Concealed wood frame reinforcer protects from kick-in attacks
- Holdback feature keeps the deadlatch in a retracted position
- Available in single and double cylinder†

#### Specifications

<b>Certifications</b>	Exceeds ANSI/BHMA certified A156.36 - 2010, Grade 2.
<b>Applications</b>	High traffic deadlatch, Grade 2 commercial exterior, new construction and retrofit applications. Often used in commercial or heavy-duty residential gate latch and night latch applications.
<b>Cylinders</b>	Solid brass 6-pin cylinder, Everest 29 S123 keyway standard. Patented Primus XP high security cylinders. Interchangeable cores available on select styles. Two nickel silver cut keys per lock. Master keying, grand master keying, and construction keying available.
<b>Deadlatch</b>	1 <sup>1</sup> / <sub>8</sub> " x 2 <sup>1</sup> / <sub>4</sub> " (29mm x 57mm), square corner faceplate, 1" (25mm) housing diameter, <sup>9</sup> / <sub>16</sub> " (14mm) throw.
<b>Standard strike</b>	1 <sup>1</sup> / <sub>8</sub> " x 2 <sup>3</sup> / <sub>4</sub> " (29mm x 70mm), square corner

#### Finishes

Series	605 US3	606 US4	609 US5	612 US10	613 US10B	619 US15	625 US26	626 US26D	626AM	643e US11
B250	▪	▪	▪	▪	▪		▪	▪		
B500	▪	▪	▪	▪	▪	▪	▪	▪	▪	▪
B600	▪	▪	▪	▪	▪	▪	▪	▪	▪	▪
B700/800	▪	▪	▪	▪	▪	▪	▪	▪	▪	▪

Complete finish chart on page 52

#### Available on B250 Series



= High traffic applications



= BHMA certified



# AL Series Grade 2 cylindrical locks



## Lever design options

Jupiter

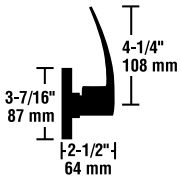

Neptune

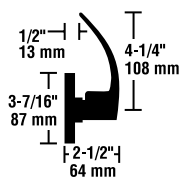

Saturn

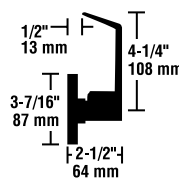

Omega

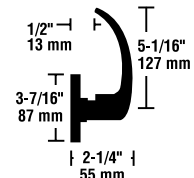

### Standard features

- Through-bolting prevents lock chassis rotation and disengagement from latch
- Stainless steel interlocking spindle design for added strength against excess force
- Heavy-duty compression springs extend life of spring cage

### Finishes

Levers	605 US3	606 US4	609 US5	612 US10	613 US10B	619 US15	625 US26	626 US26B	626	643e
Jupiter	■	■	■	■	■	■	■	■	■	■
Neptune	■	■	■	■	■	■	■	■	■	■
Omega	■	■	■	■	■	■	■	■	■	■
Saturn	■	■	■	■	■	■	■	■	■	■

Complete finish chart on page 52

### Specifications

<b>Certifications</b>	Exceeds ANSI/BHMA certified A156.2-2011, Series 4000, Grade 2, UL Listed for 3 hour fire door.
<b>Applications</b>	Medium-traffic, Grade 2 - commercial exterior, interior, new construction and retrofit applications. Often used in commercial, healthcare, hospitality, office and retail buildings.
<b>Cylinders</b>	Solid brass 6-pin cylinder, Everest 29 S123 keyway standard. Patented Primus XP high security cylinders. Interchangeable cores available on select styles. Two nickel silver cut keys per lock. Master keying, grand master keying and construction keying available.
<b>Standard latch</b>	1 1/8" x 2 1/4" (29mm x 57mm), square corner faceplate, 1" (25mm) housing diameter, 1/2" (13mm) throw.
<b>Standard strike</b>	1 1/4" x 4 7/8" (32mm x 124mm), ANSI, square corner, no box.

### Available on AL Series

= Antimicrobial coating available on select finishes

= Medium-duty traffic applications

= Helps meet LEED certification

= Complies with ADA accessibility guidelines

= BHMA certified

# A Series Grade 2 cylindrical locks

## Knob/lever design options

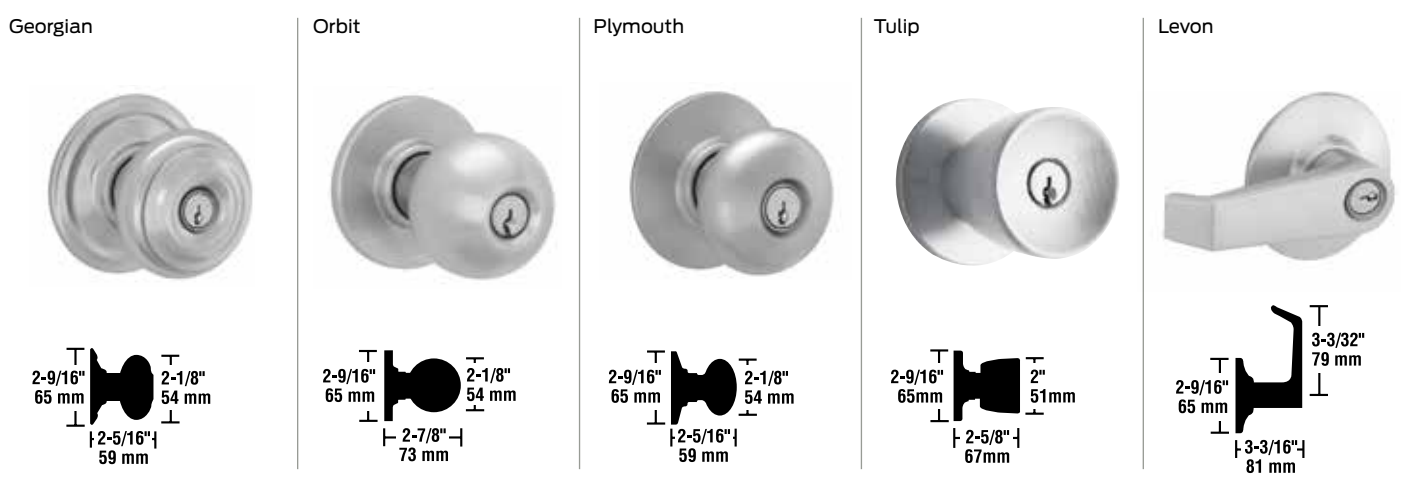

Levon is available on inside only of deadlatch and keyed functions. On keyed functions, the Levon lever is available for inside trim only.

### Standard features

- Exceeds 400,000 cycle ANSI Grade 2 requirements
- Concealed mounting screws
- Corrosion resistant lock chassis using steel and zinc dichromate plating
- Independent heavy-duty torsion springs for individual lever support

### Finishes

Knobs	605 US3	606 US4	609 US5	612 US10	613 US10B	625 US15	626 US26	629 US32	630 US32D
Georgian	■	■	■			■	■		
Orbit	■	■	■	■	■		■		
Plymouth	■	■	■	■	■	■	■	■	■
Tulip	■	■	■			■	■		
<b>Levers</b>									
Levon	■			■	■		■		

Complete finish chart on page 52

### Specifications

<b>Certifications</b>	Exceeds ANSI/BHMA certified A156.12 – 2011, Grade 2, UL Listed for 3-hour fire door.
<b>Applications</b>	Medium traffic, Grade 2 commercial exterior and interior, new construction and retrofit applications. Often used in commercial, multi-family and office buildings.
<b>Cylinders</b>	Solid brass 6-pin cylinder, Everest 29 S123 keyway standard. Patented Primus XP high security cylinders interchangeable cores available on select styles. Two nickel silver cut keys per lock. Master keying, grand master keying, and construction keying available.
<b>Deadlatch</b>	1" x 2 1/4", square corner faceplate, 7/8" housing diameter, 1/2" throw.
<b>Standard strike</b>	1 1/8" x 2 3/4" (29mm x 70mm), square corner box, deadlatch has T strike.

### Available on A Series

= Helps meet LEED certification

= Medium-duty traffic applications

= BHMA certified



# H Series cylindrical interconnected locks



## Knob/lever design options

Orbit  
Exterior trim

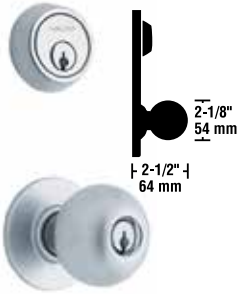

Plymouth  
Exterior trim

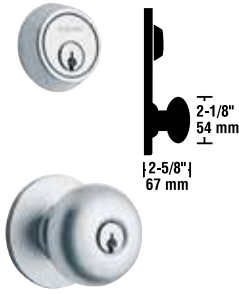

Levon  
Exterior trim



Meteor escutcheon  
Optional exterior trim



3 1/4" x 8 1/4" x 3/16"  
(83mm x 210mm x 5mm)

Levon  
Interior trim



Inside escutcheons are 2 3/4" x 6 15/16" x 5/32" (70mm x 176mm x 4mm)

### Standard features

- UL Listed for 3-hour fire door
- Single-motion egress by simultaneous retraction of deadbolt and deadlatch
- Concealed mounting screws
- 1" throw deadbolt with hardened steel roller resists sawing

### Finishes

Knobs/levers	605 US3	606 US4	609 US5	612 US10	613 US10B	625 US26	626 US26B
Levon	■			■	■		■
Orbit	■	■	■	■	■	■	■
Plymouth	■	■	■	■	■	■	■
Escutcheon							
Meteor (36-056)	■	■	■	■	■	■	■

Complete finish chart on page 52

### Specifications

Certifications	UL Listed for 3-hour fire door.
Applications	Medium traffic, commercial exterior, interior, new construction and retrofit applications. Often used in commercial, healthcare, hospitality, office and retail buildings.
Cylinders	Solid brass 6-pin cylinder, Everest 29 S123 keyway standard. Patented Primus XP high security cylinders. Interchangeable cores available on select styles. Two nickel silver cut keys per lock. Master keying, grand master keying, and construction keying available.
Standard latch	1" x 2 1/4" (25mm x 57mm) square corner faceplate, 7/8" (22mm) housing diameter, 1/2" (13mm) throw.
Standard strike	1 1/8" x 2 3/4" (29mm x 70mm), square corner, T-strike, box.

### Available on H Series

= Helps meet LEED certification
 = Medium-duty traffic applications
 = BHMA certified





## Prevent vandalism and break-in at every opening.

Allegion offers a variety of vandal-resistant hardware that is ideal for use in educational, healthcare or sports arena settings that experience high traffic and product abuse.

Technology from Schlage prevents damage to internal lock components that's caused by excessive force from kicking, hitting or standing on the lever to gain access, and prevents over-rotation of the lever, which can lead to lever sag.

### Pick-resistant Everest 29 Primus XP cylinders

from Schlage provide superior pick resistance with a high security UL437 drill-resistant cylinder, a controlled access cylinder or a mixture of both.

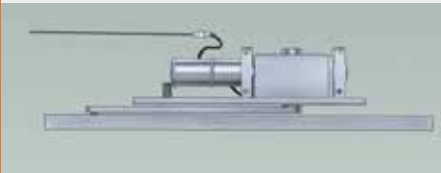
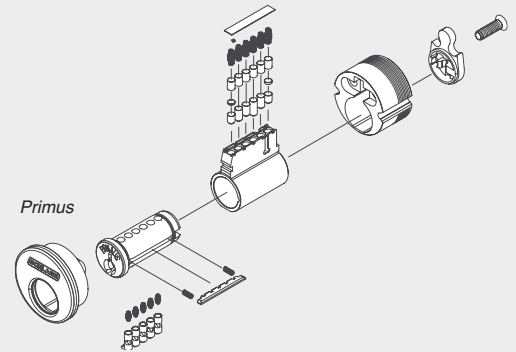

**Prevents damage** from vandalism and are ideal for areas that experience extreme weather.

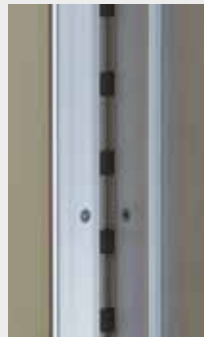

**Continuous hinges** eliminate the gap between the door and the frame, making it harder to pry open or tamper with the door, and preventing fingers from being pinched.

## Build the perfect opening with Allegion.

If you've already specified Schlage commercial locks and key systems for your project, let Allegion help you deliver the complete solution with closers and exit devices that are just as tough.

**Von Duprin exit devices** – Von Duprin pioneered the development of the panic exit device and, today, offers a full spectrum of mechanical, electronic and ADA-compliant exit devices. With a measurably less expensive life cycle cost and legendary durability, Von Duprin exit devices are ideally suited for hospitals, universities, stadiums and other high-traffic buildings. See page 116.

**LCN door closers** – LCN offers one of the industry's broadest selections of premium door closers, including heavy-duty closers for interior/exterior use, fire/life safety closers/holders, high security manual closers, and automatic operators and closers for people with physical challenges. These tough, long-lasting devices are built to perform in schools, healthcare facilities, sports arenas, and government and commercial settings. See page 94.



## S Series Grade 2 tubular locks

### Lever design options



Flair

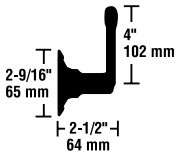

Jupiter

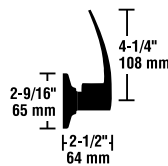

Neptune

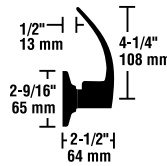

Saturn

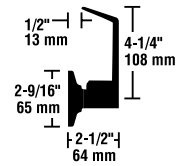

### Standard features

- Exceeds 400,000 cycle ANSI Grade 2 requirements
- Exceeds 450 Lbf-locks lever torque ANSI Grade 2 requirements
- Interlocking chassis and latchbolt
- Snap-on inside rose conceals mounting screws
- Key removable outside lever for quick and easy cylinder replacement
- S Series products installed on educational facilities are not under warranty

### Finishes

Levers	605 US3	606 US4	609 US5	613 US10B	619 US15	625 US26	626 US26B
Flair	■	■	■	■	■	■	■
Jupiter	■	■	■	■	■	■	■
Neptune	■	■	■	■	■	■	■
Saturn	■	■	■	■	■	■	■

Complete finish chart on page 52

### Specifications

Certifications	Exceeds ANSI/BHMA certified A156.2 - 2011, Series 4000, Grade 2, UL Listed for 3-hour fire door.
Applications	Light traffic, Grade 2 commercial interior, and retrofit applications. Often used in commercial, multi-family, and office buildings.
Cylinder	Solid brass 6-pin cylinder, Everest 29 S123 keyway standard. Patented Primus® XP high-security cylinders. Interchangeable cores available on select styles. Two nickel silver cut keys per lock. Master keying, grand master keying and construction keying available.
Deadlatch	1 <sup>1</sup> / <sub>8</sub> " x 2 <sup>3</sup> / <sub>4</sub> " (29mm x 70mm), square corner, T-strike, box.
Standard strike	1 <sup>1</sup> / <sub>8</sub> " x 2 <sup>3</sup> / <sub>4</sub> " (29mm x 70mm), square corner box, deadlatch has T-strike.

### Available on S Series



= Helps meet LEED certification



= Light-duty traffic applications



= BHMA certified



= Complies with ADA accessibility guidelines

# S200 Series tubular interconnected locks

## Lever design options

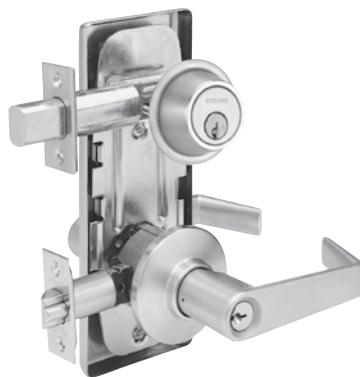

Flair



Jupiter



Neptune



Saturn



### Standard features

- Interconnected latchbolt and deadbolt chassis
- Independent heavy-duty torsion springs
- Key removable outside levers for quick cylinder replacement
- Large inside thumbturn for easy deadbolt operation

### Finishes

Levers	605 US3	606 US4	609 US5	612 US10	613 US10B	619 US15	625 US26	626 US26B
Flair	▪	▪	▪	▪	▪	▪	▪	▪
Jupiter	▪	▪			▪	▪	▪	▪
Neptune	▪	▪	▪	▪	▪	▪	▪	▪
Saturn	▪	▪	▪	▪	▪	▪	▪	▪

Complete finish chart on page 52

### Specifications

<b>Certifications</b>	UL Listed for 3-hour fire door.
<b>Applications</b>	Medium traffic, Grade 2 commercial exterior, interior, new construction and retrofit applications. Often used in commercial, multi-family and office buildings.
<b>Cylinders</b>	Solid brass 6-pin cylinder, Everest 29 S123 keyway standard. Patented Primus XP high security cylinders. Interchangeable cores available on select styles. Two nickel silver cut keys per lock. Master keying, grand master keying, and construction keying available.
<b>Deadbolt</b>	1" x 2-1/4" (25mm x 57mm), square corner faceplate, 1" (25mm) housing diameter, 1" (25mm) throw.
<b>Deadlatch</b>	1" x 2 1/4" (25mm x 57mm), square corner faceplate, 1" (25mm) housing diameter, 1/2" (13mm) throw.
<b>Standard strike</b>	1 1/8" x 2 3/4" (29mm x 70mm), square corner, box, deadlatch has T-strike.

### Escutcheon designs

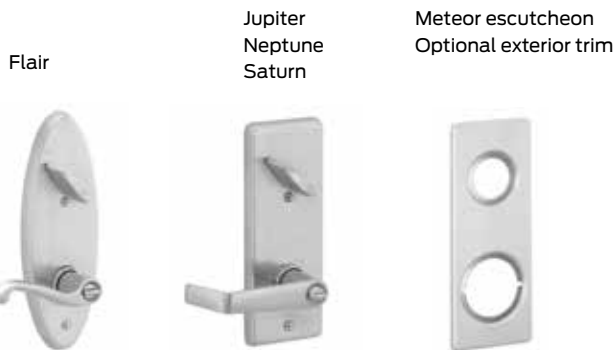

### Available on S200 Series



= Helps meet LEED certification



= Medium-duty traffic applications













= BHMA certified



= Complies with ADA accessibility guidelines













## Commercial finishes

	 605 US3	 606 US4	 609 US5	 612 US10	 613 US10B	 619 US15	 625 US26	 626 US26B	 629 US32	 630 US32D	 643e US11
<b>S Series locks</b>											
Flair	▪	▪	▪	▪	▪	▪	▪	▪			
Jupiter	▪	▪			▪	▪	▪	▪			
Neptune	▪	▪	▪		▪	▪	▪	▪			
Saturn	▪	▪	▪	▪	▪	▪	▪	▪			
<b>S200 Series locks</b>											
Flair	▪	▪	▪	▪	▪	▪	▪	▪			
Jupiter	▪	▪			▪	▪	▪	▪			
Neptune	▪	▪	▪		▪	▪	▪	▪			
Saturn	▪	▪	▪	▪	▪	▪	▪	▪			
<b>H Series locks</b>											
Levon	▪			▪	▪			▪			
Orbit	▪	▪	▪	▪	▪		▪	▪			
Plymouth	▪	▪	▪	▪	▪		▪	▪			
<b>A Series locks</b>											
Orbit	▪	▪	▪	▪	▪		▪	▪			
Georgian	▪	▪	▪				▪	▪			
Plymouth	▪	▪	▪	▪	▪		▪	▪	▪	▪	
Tulip	▪	▪	▪				▪	▪			
Levon	▪			▪	▪			▪			
<b>AL Series locks</b>											
Jupiter	▪	▪		▪	▪	▪	▪	▪			▪
Neptune	▪	▪	▪	▪	▪	▪	▪	▪			▪
Omega	▪	▪	▪	▪	▪	▪	▪	▪			▪
Saturn	▪	▪	▪	▪	▪	▪	▪	▪			▪

Schlage commercial finishes offer a full spectrum of style options. Some finishes require extended lead times and/or additional non-standard finish charges. Please consult your Allegion representative for details. 613 oil-rubbed bronze is a living finish that is designed to change in appearance over time and through daily use. Many Schlage commercial finishes can be suited with LCN door closers, Von Duprin exit devices and Schlage commercial electronics and residential locks.

## Commercial finishes

	 605 US3	 606 US4	 609 US5	 612 US10	 613 US10B	 619 US15	 625 US26	 626 US26B	 629 US32	 630 US32D	 643e US11
<b>B Series locks</b>											
B500	▪	▪	▪	▪	▪	▪	▪	▪			▪
B250	▪	▪	▪	▪	▪		▪	▪			
B600, B700, B800	▪	▪	▪	▪	▪	▪	▪	▪			▪
<b>D Series locks</b>											
Orbit	▪	▪		▪	▪		▪	▪	▪	▪	▪
Plymouth	▪	▪		▪	▪		▪	▪	▪	▪	▪
Tulip	▪	▪		▪	▪		▪	▪			▪
<b>ND Series locks</b>											
Athens	▪	▪		▪	▪	▪	▪	▪			▪
Omega	▪	▪		▪	▪	▪	▪	▪			▪
Rhodes	▪	▪		▪	▪	▪	▪	▪			▪
Sparta	▪	▪		▪	▪	▪	▪	▪			▪
Tubular	▪	▪		▪	▪	▪	▪	▪			▪
<b>L Series locks</b>											
03, 06, 07, 12, 17	▪	▪		▪	▪	▪	▪	▪	▪	▪	▪
01, 02, 05, 18	▪	▪		▪	▪	▪	▪	▪	▪	▪	▪
Asti/Merano/ Latitude/Longitude	▪	▪		▪	▪	▪	▪	▪	▪	▪	▪
Accent	▪	▪		▪	▪	▪	▪	▪	▪	▪	▪
Omega	▪	▪		▪	▪	▪	▪	▪	▪	▪	▪
M Collection M51, M52, M53, M54, M55, M56, M57, M61, M62, M63, M81, M82, M83, M84, M85	▪	▪		▪	▪	▪	▪	▪	▪	▪	▪

Schlage commercial finishes offer a full spectrum of style options. Some finishes require extended lead times and/or additional non-standard finish charges. Please consult your Allegion representative for details. 613 oil-rubbed bronze is a living finish that is designed to change in appearance over time and through daily use. Many Schlage commercial finishes can be suited with LCN door closers, Von Duprin exit devices and Schlage commercial electronics and residential locks.









## Commercial grade portable security

For integration into Schlage key systems

Padlocks, flexible steel locking cables and security chains can be master keyed into any new or existing Schlage key system, allowing you to integrate padlocks with door hardware and eliminating the need for separate keys.

These products are also compatible with Primus XP or Everest cylinders for applications that require extra security.

For a full catalog of portable security products please contact your Allegion representative.

	10 Series 1/4" shackle diameter	20 Series 5/16" shackle diameter	40 Series 3/8" shackle diameter	70 Series 7/16" shackle diameter	KC Series 15mm and 20mm cable diameter	KK Series†† 7/16" shackle diameter
<b>FINISH*</b>						
<b>Brass 606</b>		KNK**	KNK** IC			
<b>Steel 652</b>				KNK**	KNK** SFIC	
<b>Chrome plated 625</b>	SFIC	SFIC	SFIC			

\* Body finish is for appearance reference only.

\*\* Available keyed different and less cylinder. All other products less cylinder only.

\*\*\* Available keyed different.

† Chains only. Order padlock separately.

### 10 Series / 20 Series / 40 Series padlocks



### Features

- Molybdenum hardened steel shackle offers greater cut resistance
- Double deadbolt locking mechanism provides extra security
- Patented interchangeable shackle design allows for easy disassembly
- Meets or exceeds ASTM standards for standard steel shackle, shackle cutting and corrosion resistance
- Optional key retaining function

### Cylinders

#### Brass padlocks

- Schlage conventional key-in-knob (KNK) cylinder (less cylinder)
- Schlage conventional key-in-knob (KNK) cylinder (keyed different)
  - 6-pin solid brass cylinder (pinned 5)
  - Two nickel silver cut Schlage keys
- Full size interchangeable core (IC) - 40 Series only (less cylinder)

#### Chrome-plated brass padlocks

- 7-pin SFIC (less cylinder) – compatible with Schlage, Falcon, BEST, Master Lock and Arrow

### Finishes

- Solid brass body resists corrosion for all-weather performance
- Chrome-plated solid brass body resists corrosion for all-weather performance

	Body size			Shackle dimension		
	Width	Height	Depth	A	B	C
<b>10 Series</b>	1 25/32"	2 3/16"	7/8"	1/4"	1 1/2" 2"	3/4"
<b>20 Series</b>	1 25/32"	2 3/16"	7/8"	5/16"	1 1/2" 2"	3/4"
<b>40 Series</b>	1 15/16"	2 3/16"	7/8"	3/8"	1 1/2" 2"	3/4"

# Commercial grade portable security

For integration into Schlage key systems

## 70 Series / 80 Series / 90 Series padlocks

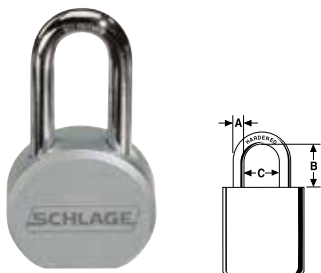

72 Series (steel) with 2" shackle

	Body size			Shackle dimension		
	Width	Height	Depth	A	B	C
<b>70 Series</b>	2 <sup>5</sup> / <sub>8</sub> "	2 <sup>3</sup> / <sub>8</sub> "	1 <sup>3</sup> / <sub>32</sub> "	7/ <sub>16</sub> "	1", 2"	7/ <sub>8</sub> "

### Features

- Molybdenum hardened-steel shackle offers greater cut resistance
- Double deadbolt locking mechanism provides extra security
- Patented interchangeable shackle design allows for easy disassembly
- Meets or exceeds ASTM standards for standard steel shackle, shackle cutting and corrosion resistance
- Optional key retaining function

### Cylinders

- Schlage conventional key-in-knob (KNK) cylinder (keyed different)
- 6-pin solid brass cylinder (pinned-5)
- Two nickel silver cut Schlage keys

### Finishes

- Case-hardened solid steel body resists impact

## KS Series padlock parts

### SFIC

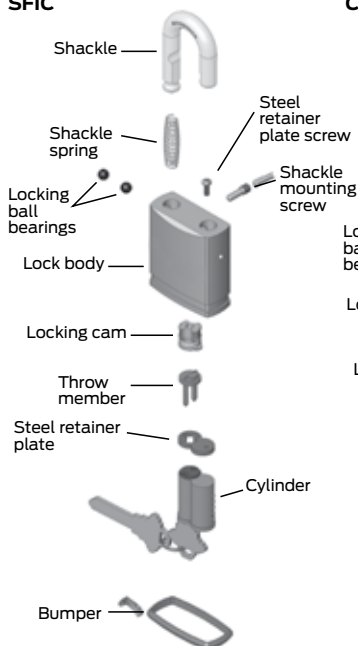

### Conventional key-in-knob

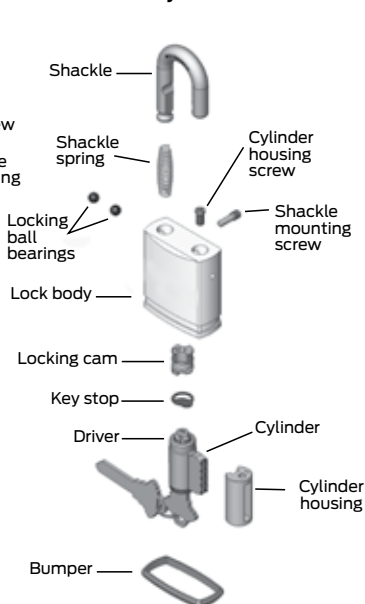

## KC Series locking cables



	Cable size	
	Length	Diameter
<b>KC215E Series</b>	6"	5/ <sub>8</sub> " (15mm)
<b>KC215A Series</b>	2"	
<b>KC215B Series</b>	4"	

All are available keyed

KC215 Series

### Features

- Braided steel vinyl-coated cable provides greater cut resistance than twisted cable
- Dust cover protects cylinder from dirt and grime

### Cylinders

- Schlage conventional key-in-knob (KNK) cylinder (keyed different)
  - 6-pin solid brass cylinder (pinned-5)
  - Two nickel silver cut Schlage keys
- 7-pin SFIC (less cylinder) – compatible with Schlage, Falcon, BEST, Master Lock and Arrow

### Finishes

- Integrated die-cast zinc locking head (407 satin finish)

## KK Series security chains



	Chain length
<b>KKX16 Series</b>	3' 3"
<b>KKY16 Series</b>	5"

KKY Series

### Features

- Triple heat-treated boron manganese steel chain
- Unique trapezoidal-shaped links for maximum cut resistance
- Ships with KS72F2300 solid steel round padlock
- Chain and padlocks must be ordered separately
- Recommended for use with KS72F2300 solid steel round padlock

## Parts and accessories

A full range of padlock, cable parts and accessories are available for you to order, including a complete service repair kit, additional shackles and a 9" retaining chain.

## KC Series cable parts

### Conventional key-in-knob

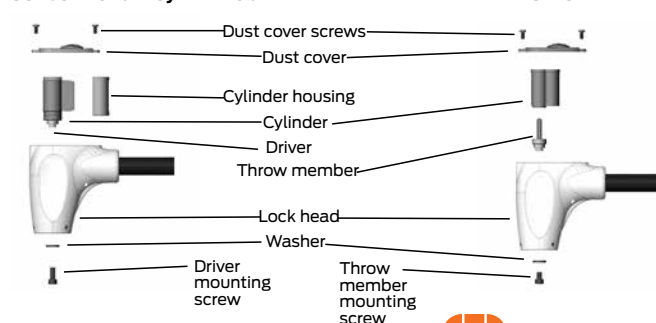

### SFIC





# CL Series cabinet locks conventional cylinder

## CL Series cabinet and drawer locks

### Conventional cylinder



Cabinet door lock - CL100PB

Rekeyable: Easily rekeyed via patented set-screw cylinder removal mechanism

Certifications: ANSI A156.11, Grade 2

Body: Die cast zinc

Bolt: Brass, <sup>15</sup>/<sub>16</sub>" projection

Door thickness: <sup>7</sup>/<sub>8</sub>" to 1<sup>3</sup>/<sub>8</sub>"

Barrel diameter: 1<sup>1</sup>/<sub>8</sub>"

Cylinder: Schlage Everest 29 S123

Keying: KD, KA or MK

Finishes: 626 and 605

Not available without cylinder.



Drawer lock - CL200PB

Rekeyable: Easily rekeyed via patented set-screw cylinder removal mechanism

Certifications: ANSI A156.11, Grade 2

Body: Die cast zinc

Bolt: Steel, <sup>3</sup>/<sub>4</sub>" throw

Door thickness: <sup>7</sup>/<sub>8</sub>" to 1<sup>3</sup>/<sub>8</sub>"

Barrel diameter: 1<sup>1</sup>/<sub>8</sub>"

Cylinder: Schlage Everest 29 S123

Stock keying: KD, KA or MK

Finishes: 626 and 605

Not available without cylinder.

### Finishes

See product description for available finishes.

Bright brass 605



Satin chrome 626



### Full size interchangeable core (FSIC)



Cabinet door lock - CL777R

Rekeyable: Easily rekeyed via patented set-screw cylinder mechanism

Certifications: ANSI A156.11, Grade 1

Body: Die cast zinc

Bolt: Brass, <sup>15</sup>/<sub>16</sub>" projection

Barrel length: 1<sup>7</sup>/<sub>16</sub>"

Barrel diameter: 1<sup>1</sup>/<sub>8</sub>"

Cylinder: Primus XP, Everest or Classic

Keying: KA, KD, MK or construction core

Finishes: 626 and 605

Not available without cylinder.



Drawer lock - CL888R

Rekeyable: Easily rekeyed via patented set-screw cylinder mechanism

Certifications: ANSI 156.11, Grade 2

Body: Die cast zinc

Bolt: Brass, <sup>7</sup>/<sub>8</sub>" projection

Door thickness: <sup>7</sup>/<sub>8</sub>" to 1<sup>3</sup>/<sub>8</sub>"

Barrel diameter: 1<sup>1</sup>/<sub>8</sub>"

Cylinder: Primus XP, Everest or Classic

Keying: KA, KD, MK or construction core

Finishes: 626 and 605

Not available without cylinder.



Cam lock - CL920R

Body: Die cast zinc

Body diameter: 1<sup>1</sup>/<sub>8</sub>"

Mounting cutout: 1<sup>5</sup>/<sub>32</sub>"

Max material thickness: 1<sup>1</sup>/<sub>8</sub>"

Min material thickness: 0.08"

Across flats: <sup>7</sup>/<sub>8</sub>"

Cylinder: Primus XP, Everest or Classic

Keying: KA, KD, MK or construction core

Finishes: 626 and 605

Not available without cylinder.



## Cylinders for exit devices, aluminum door, etc.

### CL Series cabinet locks

CL1000

CL2009

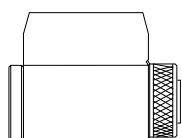

Door

Drawer

Application	Bolt	Complete lock			Cylinder only		
		Conventional	Primus/ Primus XP	Primus/ Primus XP UL	Conventional	Primus XP	Primus UL
Door	1" (std)	CL100PB	CL1740PB CL1740PB-XP	CL1540PB CL1540PB-XP	20-172	20-772XP	20-572
Drawer	$\frac{3}{4}$ " (std)	CL200PB	CL2749PB	CL2549PB	20-174	20-774XP	20-574

Available 605 and 626 finish. Everest 29 S123 keyway standard.



## Choose the right level of key control.



### Protect new key systems with Everest 29™

Schlage can help you design a system that can grow and change along with your needs, allowing you the flexibility to upgrade your security without the need to replace all your cylinders.

What it operates	What it is
<ul style="list-style-type: none"> <li>Everest 29 Primus® XP cylinders</li> <li>Everest 29 restricted cylinders</li> <li>Everest 29 open cylinders</li> </ul>	<p><b>UL 437 Version</b></p> <ul style="list-style-type: none"> <li>UL 437 versions provide drill and pick resistance and withstand physical attack</li> <li>High security cylinders have a second set of pins for added security</li> <li>Patented key control sold with various levels of geographic exclusivity</li> <li>Keys operate high security, as well as restricted security or standard security cylinders</li> <li>Available only in conventional</li> </ul>
<ul style="list-style-type: none"> <li>Everest 29 Primus XP cylinders</li> <li>Everest 29 restricted cylinders</li> <li>Everest 29 open cylinders</li> </ul>	<p><b>Controlled access</b></p> <ul style="list-style-type: none"> <li>Patented key control sold with various levels of geographic exclusivity</li> <li>High security cylinders have a second set of pins for added security and pick resistance</li> <li>Keys operate high security, as well as restricted security or standard security cylinders</li> <li>Available only in conventional and FSIC</li> </ul>  <p><b>EVEREST 29™ PRIMUS XP HIGH SECURITY</b></p>
<ul style="list-style-type: none"> <li>Everest 29 restricted cylinders</li> </ul>	<ul style="list-style-type: none"> <li>Key distribution is restricted—duplication must be authorized</li> <li>End user's ID numbers are stamped on all keys, enabling Schlage to identify the source of any unauthorized keys</li> <li>Patent-protected keys are drop-shipped from the factory directly to an end-user specified location to guarantee exclusivity</li> <li>Available in conventional, SFIC and FSIC</li> </ul>  <p><b>EVEREST 29™ RESTRICTED SECURITY</b></p>
<ul style="list-style-type: none"> <li>Everest 29 open cylinders</li> </ul>	<ul style="list-style-type: none"> <li>Patented key blanks can be stored by commercial locksmiths and security dealers</li> <li>Keys can be duplicated without any paperwork or signature verification</li> <li>Sold only through commercial outlets</li> <li>Available in conventional and FSIC</li> </ul>  <p><b>EVEREST 29™ STANDARD SECURITY</b></p>

### Upgrade existing classic key systems with Primus XP

Schlage offers key system solutions that are ideal for upgrading an existing key system to control key management. Our patent-protected cylinders help prevent unauthorized duplication and can be integrated into virtually any existing system.

What it is	What it operates
<p><b>UL 437 Version</b></p> <ul style="list-style-type: none"> <li>UL 437 versions provide drill and pick resistance and withstand physical attack</li> <li>High security cylinders have a second set of pins for added security</li> <li>Patented key control sold with various levels of geographic exclusivity</li> <li>Keys operate high security, as well as restricted security or standard security cylinders</li> <li>Available only in conventional</li> </ul>	<ul style="list-style-type: none"> <li>Primus XP cylinders</li> <li>Classic cylinders</li> </ul>
<ul style="list-style-type: none"> <li>UL 437 versions provide drill and pick resistance and withstand physical attack</li> <li>High security cylinders have a second set of pins for added security</li> <li>Patented key control sold with various levels of geographic exclusivity</li> <li>Keys operate high security, as well as restricted security or standard security cylinders</li> <li>Available only in conventional</li> </ul>	<p><b>Controlled access</b></p> <ul style="list-style-type: none"> <li>Patented key control sold with various levels of geographic exclusivity</li> <li>Primus XP cylinders</li> <li>Classic cylinders</li> </ul>
 <p><b>PRIMUS XP HIGH SECURITY</b></p>	<ul style="list-style-type: none"> <li>Patented key control sold with various levels of geographic exclusivity</li> <li>High security cylinders have a second set of pins for added security and pick resistance</li> <li>Keys operate high security, as well as restricted security or standard security cylinders</li> <li>Available only in conventional</li> </ul>
 <p><b>CLASSIC BASIC SECURITY</b></p>	<ul style="list-style-type: none"> <li>Keys can be duplicated at most retail and commercial points of sale with no restrictions</li> <li>Recommended only for residential applications or existing commercial systems that cannot rekey</li> <li>Can be upgraded to Primus XP without rekeying the entire facility</li> <li>Available in conventional and FSIC</li> </ul>

# Primus® XP high-security patented key control system

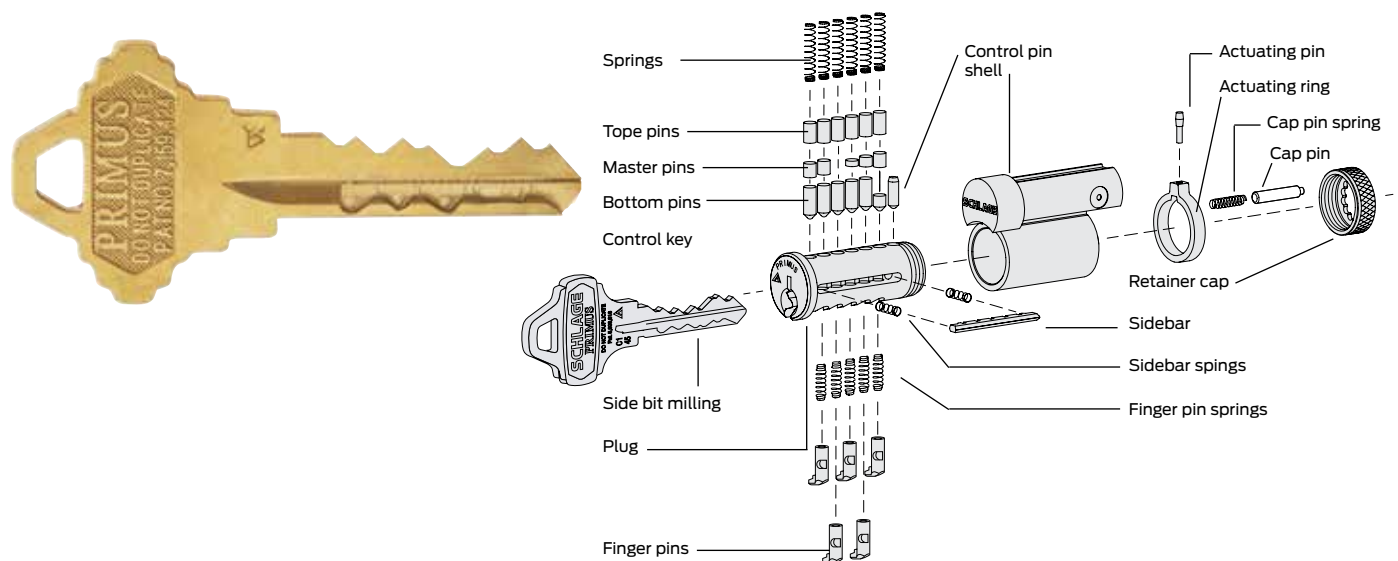

The Schlage Primus XP high-security key control system offers keys that are geographically exclusive to either an authorized Schlage Primus XP dealer or to an end user's facility. All Schlage Primus keys require verification of a pre-authorized signature before keys can be duplicated or reordered. Primus XP is strongly recommended for facilities where sensitive materials, theft or personal protection are a concern, such as educational facilities, hospitals, large office complexes and government facilities.

Primus XP side bit millings offer a unique "fingerprint" of the key that is used to geographically control the distribution of keys. Primus XP systems are available in Classic, Everest and Everest 29 keyways. Primus XP is available in the 20-700-XP controlled access series and the drill-resistant 20-500-XP high-security UL 437 rated Series.

## Specifications

<b>Applications</b>	Fine homes, multi-family housing, retail stores, office and commercial space, schools, universities, hospitals, industrial sites and wherever key control and physical security are important concerns.
<b>Certifications</b>	20-500 high-security cylinder: UL/cUL 437 listed; ANSI A156.5, 1992, Grade 1. 20-700 controlled access cylinder: ANSI A156.5, 1992, Grade 1 operational.
<b>Keying</b>	6-pin with two nickel silver keys per lock. Primus XP allows integration with existing standard Schlage key systems by utilizing a Primus XP key to operate both Primus XP cylinders, as well as Schlage standard pin tumbler cylinders. Primus XP keys can be cut to operate all cylinders while standard keys will not operate Primus XP cylinders. Primus XP cylinders may be master or grand master keyed.
<b>Product compatibility</b>	Primus XP cylinders can be used with: A, AL, B, CL, D, ND, H, L, S, S200 Series locks, KS Series padlocks and KC Series locking cables. All Primus XP cylinders are available in key-in-knob/lever, mortise, rim and a variety of competitor retrofit formats. 20-700 controlled access cylinders are also available in Schlage's family of full size interchangeable core cylinders.

## Finishes

	Primus	605	606	609	610	611	612	613	616	619	625	626	629	630
<b>Cores</b>			■											■
<b>Cylinder Plugs</b>			■											■
<b>Cylinders</b>														
<b>Mortise</b>	■	■	■	■	■	■	■	■	■	■	■	■	■	■
<b>Rim</b>	■	■	■	■	■	■	■	■	■	■	■	■	■	■
<b>Interchangeable core cylinder housings</b>														
<b>Mortise</b>	■	■	■	■	■	■	■	■	■	■	■	■	■	■
<b>Rim</b>	■	■	■	■	■	■	■	■	■	■	■	■	■	■

See finish chart on page 52



# Key control system security levels

The Primus system features multiple levels of security. For the classic Primus XP system, security increases from level one through level four. For Everest 29 Primus XP, security increases from level seven to level nine. Each level requires an appropriate ID card and/or signature verification for key duplication. All levels utilize patent-protected Primus cylinders and keys to protect against unauthorized duplication. To select the proper level of security, consideration should be given to the overall key control, convenience and service required for the installation.

High security and patented cylinders patented keys distributed with geographic exclusivity

**CLASSIC Primus XP**  
Ideal for existing key systems  
patent protected through 2024



**EVEREST 29<sup>™</sup> XP**  
PRIMUS

Ideal for new key systems  
patent protected through 2029



## Typical applications

LEVEL XP	Dealer controlled system	<p><b>National non-exclusive</b> Stocked by distributors and resold to end users via commercial locksmiths; All Level 1 locksmiths have the same side bit millings.</p>	<ul style="list-style-type: none"> <li>Strip mall shops</li> <li>Small businesses</li> <li>Upscale homes</li> </ul>	<p>Consider Everest open for commercial exclusivity</p>	Dealer controlled system	LEVEL XP
		<p><b>Dealer exclusive</b> Owned and stocked by dealers; resold to end users. Keys bear unique Dealer ID based upon three digit zip-code exclusivity of side bit milling.</p>		<p><b>Dealer exclusive</b> Owned and stocked by dealers; resold to end users. Keys bear unique dealer ID based upon three digit zip-code, exclusivity of side bit milling.</p>		
LEVEL XP	Dealer controlled system	<p><b>Dealer exclusive</b> Dealers that sell directly to end users are eligible for side bit milling exclusivity. Exclusivity is for the dealer physical location time zone.</p>	<ul style="list-style-type: none"> <li>Office buildings</li> <li>Banks</li> <li>Private schools</li> <li>Healthcare residences</li> </ul>	<p><b>Dealer exclusive</b> Dealers that sell directly to end users are eligible for side bit milling exclusivity. Exclusivity is for the dealer physical location time zone.</p>	Dealer controlled system	LEVEL XP
LEVEL XP	End user exclusive systems	<p><b>End user exclusive</b> Exclusivity is based on either random assignment or on the first 2 digits of the zip code, depending on end user commitment.</p>		<ul style="list-style-type: none"> <li>Educational facilities</li> <li>Healthcare facilities</li> <li>Large office complexes</li> <li>Government buildings</li> <li>Detention centers</li> <li>Franchises</li> </ul>	<p><b>End user exclusive</b> Exclusivity is based on random assignment, on the first 2 digits of the zip code, on time zone, or on a nationwide basis, depending on end user commitment.</p>	End user exclusive systems
LEVEL XP	End user exclusive systems	<p><b>End user exclusive</b> Exclusivity is based on either a time zone or nationwide basis, depending on end user commitment.</p>				



## Full size interchangeable core (FSIC)



23-030  
Interchangeable core



Rhodes



Orbit



Saturn



L Series



Rim cylinders



B762R



KS43F

Schlage interchangeable core cylinders allow the immediate rekeying of a lock without the time and expense of repinning cylinders. The replacement core is installed or replaced with the use of a control key. Schlage interchangeable cores are compatible with a large selection of lock designs, finishes and functions. Interchangeable cores are available in the 20-700 Primus XP controlled access series, as well as in the Everest 29 patent-protected keying system. To order locks with interchangeable core cylinders change the product suffix from P to R. Example: D53RD.

### A Series, AL Series, D Series, H Series and S Series:

Athens, Jupiter, Neptune, Orbit, Rhodes, Saturn and Sparta designs for interchangeable core are available as complete locks or in retrofit kits. When ordering, specify design, finish and keying requirements.

### Retrofit kits:

A Series, H Series and AL Series	01-054
D Series	04-034
ND Series	03-032 (lever only)
S Series	08-030

### Installation tool:

M504-413 (order as needed).

### L Series, mortise cylinders:

All L Series keyed functions are available with interchangeable core cylinders. Complete lock units are furnished with compression and blocking rings for 1<sup>3</sup>/<sub>4</sub>" (44mm) doors. Specify door thickness if other than 1<sup>3</sup>/<sub>4</sub>" (44mm).

### B Series, H Series and S Series:

1" (25mm) trim rings and hardened steel inserts are provided for 1<sup>3</sup>/<sub>4</sub>" (44mm) doors. B600/700 Series furnished with solid 1<sup>1</sup>/<sub>8</sub>" (29mm) trim rings. (Ring/insert sizes vary according to door ranges.) All listed functions are available with interchangeable cores except H185 lower cylinders.

### Finishes:

605, 606, 612, 613, 625, 626. (H110 is available in all listed finishes.)

### Rim cylinders:

The interchangeable core rim cylinder has the cylinder bar affixed to the cylinder housing. Rotating the bar either horizontally or vertically adapts the cylinder for use with most rim cylinder applications.

### Padlocks:

KS43 Series, solid brass and KS72 and KS92 Series, solid steel padlocks are available for use with full size interchangeable cores. All padlocks ship less cylinder.

## Small format interchangeable core (SFIC)



### Schlage patented keyways

Schlage Everest 29 R delivers even higher performance and longer life for the cores thanks to a proprietary manufacturing process. This Schlage Everest 29 patented SFIC is protected from unauthorized key duplication under U.S. Utility Patent 7,665,337.

Combined 80-037  
Uncombined 80-036



### BEST®

Keyways 6- and 7-pin uncombined cores in two finishes and the ten most popular BEST keyways: A, D, E, F, G, H, J, K, L and M. To order cores, specify the product number and add suffix "B" to the keyway letter. For example: order 7-pin "A" keyway core as 80-033 AB. These cores can be combined in any depth system and work with most existing service equipment.

6-pin 80-043,  
7-pin 80-033

### Specifications

<b>Applications</b>	Retail stores, office and commercial space, schools, universities, hospitals, industrial sites and wherever key control and physical security are a priority.
<b>Certifications</b>	ANSI 156.5, 1992, Grade 1 operational.
<b>Keying</b>	Pin tumbler with two nickel silver keys per lock. Patented cores may be master keyed or grand master keyed.

### Standard features

- 7-pin cores with a "check pin" operable only by patented Everest 29 keys.
- Utility patents help protect keys from unauthorized duplication.
- Cores retrofit into competitor SFIC prepared locksets.

### Finishes

SFIC cylinders	605	606	609	612	613	616	619	625	626	629	630
Schlage patented		▪			▪					▪	
Best		▪								▪	
<b>SFIC Series</b>											
AL	▪	▪	▪	▪	▪	▪	▪	▪	▪	▪	▪
B600	▪	▪	▪	▪	▪	▪	▪	▪	▪	▪	▪
ND	▪	▪	▪	▪	▪	▪	▪	▪	▪	▪	▪
L400	▪	▪	▪	▪	▪	▪	▪	▪	▪	▪	▪
L9000	▪	▪	▪	▪	▪	▪	▪	▪	▪	▪	▪
<b>SFIC cylinder housings</b>											
Mortise	▪				▪		▪		▪	▪	▪
Rim	▪				▪		▪		▪	▪	▪

See finish chart on page 52

### Padlocks and cables

KS11, KS21, KS41, KS72, KS82 and KS92 Series padlocks and KC Series cables are available for use with SFIC cylinders. All padlocks ship less cylinder.

### Specifications

<b>Applications</b>	For commercial and institutional buildings where BEST key systems exist.
<b>Certifications</b>	ANSI 156.5, 1992, Grade 1 operational.
<b>Keying</b>	Schlage does not offer factory master keying on this product.

### Standard features

- 6- and 7-pin cores available.
- Can be keyed into existing BEST key systems.

SFIC is available with the AL and ND Series cylindrical locks, B500 Series deadbolts, B600 Series deadbolts, L400 Series small case mortise deadbolts, L9000 Series mortise locks, Schlage padlocks and locking cables, and mortise and rim cylinders. To order locks less core, change the product suffix from P or PD to BD. For locks with temporary SFIC construction cores, change the suffix from P or PD to HD. For locks with the patented-protected Everest SFIC core, change the suffix from P or PD to GD. For example: AL53PD should be ordered as AL53BD, AL53HD or AL53GD.

### Mortise cylinders

Since the cam on the SFIC mortise cylinder is retained by a screw, SFIC mortise cylinders can be easily adapted to operate a variety of other manufacturers' mortise locks and exit devices.

### Rim cylinders

The SFIC rim cylinder has the cylinder bar affixed to the cylinder housing. Rotating the bar either horizontally or vertically adapts the cylinder for use with most applications.



## Accessories and service

### Keys

All Schlage locks come standard with two nickel silver keys, embossed with our company logo. When special stamping is required for key identification, keys can be ordered without embossing. Also, Schlage will stamp "DO NOT DUPLICATE" across the bow of its keys at no extra charge when specified.

### Mortise cylinders:

Schlage mortise cylinders are made of a solid brass cylinder held in a Stainless Steel front and back housing and manufactured to precise specifications. Full face cylinders can be provided with compression rings, with an adjustment range of  $\frac{1}{16}$ " (2mm) to  $\frac{3}{32}$ " (4mm). Changing the cam adapts the cylinder for use with a variety of mortise locks and exit devices. Cylinder #30-001 is standard for all Schlage L Series locks. Cylinder #20-001, used for the outside of function L9060, is standard for most mortise locks and exit devices. Additional cams are available for Schlage mortise cylinders to operate other manufacturers' mortise locks. Everest, Everest 29, Primus and Primus XP cylinders utilize the same standard cam.

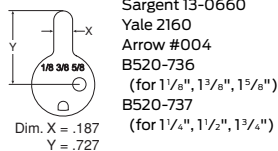
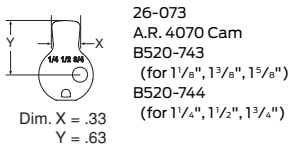
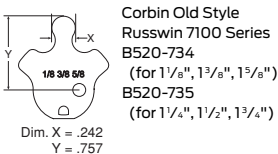
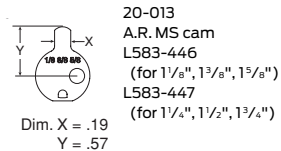
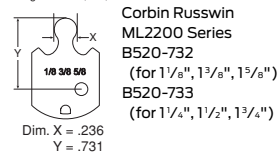
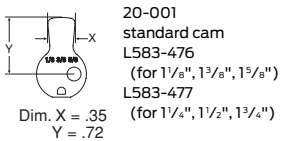
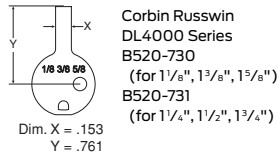
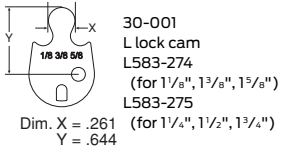
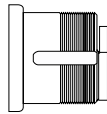

### SITEMASTER 200®

SiteMaster 200 is a complete key and facility management software, designed for end users and service providers, that allows you to track and manage keys, rooms, buildings, assets and personnel. Designed for simplicity, the program is a cost efficient method of creating and maintaining key control. SiteMaster 200 is particularly effective when used with Classic Primus XP or Everest Primus XP high-security cylinders for assurance of complete key control.

### Applications:

Commercial, industrial, institutional or government facilities.

### Format:

Windows® compatible.

- Create, expand or maintain multiple key systems.
- Manage doors, door hardware, rooms, buildings, keys and cylinders.
- Track facility personnel and assets.
- Print receipts, tracking reports and budgets.
- Import key and door hardware schedules directly from Spextra.

### Rim lock cylinders

These cylinders are used with various exit devices and nightlatches. Orientation of the cylinder bar determines the part number for the complete cylinder. A  $\frac{3}{16}$ " (30mm) bore is required to fit the trim collar. Rim cylinders also available with Primus XP high-security cylinders.

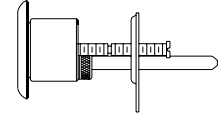

20-021 #1 bar  
20-022 #2 bar

### Retrofit cylinders

All of the following are available with Conventional, Primus, Primus XP and Primus UL437XP cylinder mechanisms.

#### Corbin Russwin retrofit cylinders

CL3300
CL3400
CL3600
C303-437
CL3600
CK4200/UT5200 (since 1963)

#### Sargent retrofit cylinders

7L, 8L, 10 line levers
7, 8, 9 line knobs
6 line except B knob

#### Yale retrofit cylinders

5300LN, 5400LN levers
5300, 5400, 6200 Series knobs

Sargent® is a registered trademark of Assa Abloy. Yale® is a registered trademark of Yale Security Co. Arrow® is a registered trademark of the Arrow Lock Manufacturing Co. Corbin Russwin® is a registered trademark of Corbin Russwin, Inc.

### Finishes









Cylinders	605	606	609	612	613	616	619	625	626
Mortise and rim	■	■	■	■	■	■	■	■	■
Mortise IC	■	■	■	■	■	■	■	■	■
Rim IC	■	■	■	■	■	■	■	■	■

See finish chart on page 52











## Mechanical lock functions









### ANSI A156.2, 1996, Series 4000 Non-keyed locks

								
	<b>Passage latch</b>	<b>Exit lock</b>	<b>Exit lock</b>	<b>Patio lock</b>	<b>Bed/bath privacy lock</b>	<b>Communicating lock</b>	<b>Hospital privacy lock</b>	<b>Single dummy trim</b>
<b>Schlage</b>	A10S / Grade 2 AL10S / Grade 2 ND10S / Grade 1 FA10/F10 / Grade 2 S10D / Grade 2	ND12D / Grade 1	A25D	A30D / Grade 2	A40S / Grade 2	A43D / Grade 2	ND44S	A170
<b>ANSI</b>	F75	F89	-	F77	F76	F79	-	
	Both knobs/levers always unlocked. D10● / Grade 1	Outside lever always fixed. Inside always unlocked.	Blank plate outside. Inside knob always unlocked.	Push-button locking. Turning inside knob releases button, preventing opening or closing door.	Push-button locking. Turning inside knob/ lever releases push-button. Can open from outside via emergency release. D40● / Grade 1 ND97H ● / Grade 1	Turn-button in outer knob locks and unlocks knob and inside thumbturn.	Push-button locking. Unlocked from outside by turning emergency turn-button. Turning inside knob/lever closing door releases button.	Single dummy trim for one side of door. Used for door pull or inactive matching trim.

### ANSI A156.2, 1996, Series 4000 Keyed locks (cont'd)

								
	<b>Entrance lock</b>	<b>Entrance/office lock</b>	<b>Entrance lock</b>	<b>Vestibule lock</b>	<b>Store lock</b>	<b>Classroom lock</b>	<b>Communicating lock</b>	<b>Corridor lock</b>
<b>Schlage</b>	FA51/F51/ Grade 2 S51PD / Grade 2	AL50PD / Grade 2 ND50PD / Grade 1 ND91PDH / Grade 1	A53PD / Grade 2 AL53PD / Grade 2 ND53PD / Grade 1 ND92PD H / Grade 1 D53PD L / Grade 1	ND60PD / Grade 1 ND93PD H D60PD L / Grade 1	ND66PD/Grade 1 D66PD L / Grade 1	A70PD / Grade 2 AL70PD / Grade 2 ND70PD / Grade 1 ND94PD H / Grade 1 D70PD L / Grade 1	ND72PD <sup>†</sup> /Grade D72PD L /Grade 1	ND73PD / Grade 1 D73 L / Grade 1 S70PD / Grade 2
<b>ANSI</b>	F81	F82	F109	F88	F91	F84	F80	F90
	Turn button locking. Unlocked by key from outside. Inside always unlocked.	Unlocked by key from outside or turning inside lever.	Turn/push-button locking. Unlock with key or manual turn/push button release.	Latch retracted by key from outside. Inside always unlocked. Locked or unlocked by key inside.	Key in either knob/lever locks or unlocks both sides.	Outside knob/lever locked and unlocked by key. Inside always unlocked.	Key in either knob locks or unlocks each knob independently.	Locked or unlocked by key from outside. Push-button locking from inside. Turning inside knob or closing door releases buttons.

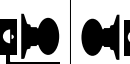
### ANSI A156.2, 1996, Series 4000 Keyed locks (cont'd)

									
	<b>Classroom security lock</b>	<b>Communicating lock</b>	<b>Storeroom lock</b>	<b>Institution lock</b>	<b>Hotel/motel lock</b>	<b>Electrically locked</b>	<b>Electrically unlock</b>	<b>Electrically lock</b>	<b>Electrically unlock</b>
<b>Schlage</b>	ND75PD / Grade 1 ND95PDH / Grade 1	A79PD	A80PD / Grade 2 AL80PD / Grade 2 ND80PD / Grade 1 ND96PDH / Grade 1 FA80/F80 / Grade 2 S80PD / Grade 2 D80PD / Grade 1	ND82PD <sup>†</sup> / Grade 1 D82 ● / Grade 1	A85PD / Grade 2 AL85PD / Grade 2 ND85PD / Grade 1 D85 ● / Grade 1	ND80PDEL D80PDEL ● D96PDEL ●	ND80PDEU	ND12DEL	ND12DEU
<b>ANSI</b>	-	-	F86	F87	F93	-	-	-	-
	Key in either lever locks or unlocks outside lever. Inside lever is always unlocked.	Locked or unlocked by key from outside. Blank plate inside.	Outside knob/lever fixed. Key only. Inside knob/lever always unlocked.	Both knobs/levers fixed. Entrance by key in either knob/lever.	Outside knob fixed. Key only. Push-button in inside knob.	Outside locked continuously electrically. Unlock by key/switch/power failure.	Outside fixed. Unlock by key/ electric current. Inside always unlocked.	Outside fixed. Inside always unlocked.	Outside locked continuously until unlocked electrically. Auxiliary latch deadlocks latchbolt when door is closed. Inside always free.

• Available function for Athens, Rhodes and Sparta designs.

★ Vandalgard<sup>®</sup> function for lever designs only.

† Caution: Double cylinder locks on residences and any door in any structure which is used for egress are safety hazards in times of emergency and their use is not recommended. Installation should be in accordance with existing codes only.







● Knob designs only.



## Mechanical lock functions









### ANSI A156.2, 1996, Series 4000 Keyed locks (cont'd)

### ANSI A156.5, 1992 Bored deadbolt locks





						
	<b>Single cylinder deadbolt lock</b>	<b>Double cylinder</b>	<b>One-way deadbolt lock</b>	<b>Classroom deadbolt lock</b>	<b>Cylinder lock</b>	<b>Door bolt</b>
<b>Schlage</b>	BC160P / Grade 2 BA360 / Grade 2 B360N / Grade 2 B660P / Grade 1 B760P / Grade 1 B860P / Grade 1	BC162P <sup>†</sup> / Grade 2 BA362 <sup>†</sup> / Grade 2 B362N <sup>†</sup> / Grade 2 B662P <sup>†</sup> / Grade 1 B762P <sup>†</sup> / Grade 1 B862P <sup>†</sup> / Grade 1	B661P / Grade 1 B761P / Grade 1 B761P / Grade 1 B861 / Grade 1	B663P / Grade 1 B763P / Grade 1 B763P / Grade 1 B863 / Grade 1	B664P / Grade 1 B764P / Grade 1 B864P / Grade 1 B864 / Grade 1	BC180 / Grade 2 B380 / Grade 2 B680 / Grade 1
<b>ANSI</b>	E2153, E2152, E2151	E2143, E2142, E2141	E2161	E2171	E2101	E2193, E2192, E2191
	Thrown/retracted by key outside/inside unit. Deadlocks when fully thrown.	Thrown/retracted by key either side. Deadlocks when fully thrown.	Thrown/retracted by key only. Blank inside. Deadlocks when fully thrown.	Thrown/retracted by key outside. Inside retract bolt only. Deadlocks when thrown.	Thrown/retracted by key one side. No trim inside. Deadlocks when fully thrown.	Thrown/retracted by turn unit only. No outside trim. Deadlocks when thrown.

### ANSI A156.2, 1996, Bored deadlatch locks





### ANSI A156.5, 1992 Mortise deadbolt locks

								
	<b>Night latch</b>	<b>Double cylinder deadlatch</b>	<b>Cylinder x thumbturn</b>	<b>Double cylinder</b>	<b>Classroom lock</b>	<b>Cylinder lock</b>	<b>Deadbolt</b>	<b>Deadbolt with "OCCUPIED" Indicator</b>
<b>Schlage</b>	B250PD / Grade 2	B252PD <sup>†</sup> / Grade 2	L460P / Grade 1	L462P / Grade 1	L463P / Grade 1	L464P / Grade 1	L480	L496
<b>ANSI</b>	E2122	E2112	E06071	E06061	E06091	E06081	-	-
	Retracted by key outside/inside unit. Hold-back feature keeps latch retracted.	Retracted by key either side. No hold-back feature.	Thrown/retracted key outside/ thumbturn inside.	Key either side.	Thrown/retracted key outside. Inside retracts only.	Thrown/retracted key one side. No trim opposite side.	Thrown/retracted thumbturn one side. No trim opposite side.	Deadbolt thrown or retracted by key outside or thumbturn inside. When deadbolt is thrown "OCCUPIED" plate is displayed. (Previously XL11-911)

### ANSI A156.5, 2001, Auxiliary locks and ANSI A156.2, 2003, Bored locks and latches









				
	<b>Keypad deadbolt single locking</b>	<b>Keypad front entry/entrance, single locking</b>	<b>Keypad entry with flex-lock</b>	<b>Keypad entry with auto-lock</b>
<b>Schlage</b>	BE365 / Grade 2	FE365 / Grade 2	FE595 / Grade 2	FE575 / Grade 2
<b>ANSI</b>	E2122	E2112	E06071	E06061
	Deadbolt thrown from outside by keyway turn after pressing Schlage button or by inside thumbturn. Deadbolt retracted from outside by entering valid user code then rotating keyway turn or by inside thumbturn. Key can be used to unlock as backup.	Deadbolt thrown from outside by keyway turn after pressing Schlage button or by inside thumbturn. Deadbolt retracted from outside by entering valid user code then rotating keyway turn or by inside thumbturn. Key can be used to unlock as backup.	Flex-Locking, choose to remain unlocked from outside by rotating inside thumbturn. Unlocked by valid user code from outside. Inside lever/knob always unlocked. Key can be used to unlock as back-up.	Auto-locking. Unlocked by valid user code from outside. Inside lever/knob always unlocked. Key can be used to unlock as back-up.

### ANSI A156.12, 1992 Interconnected locks

					
	<b>Entrance single locking</b>	<b>Entrance double locking</b>	<b>Entrance double locking</b>	<b>Classroom lock</b>	<b>Storeroom lock</b>
<b>Schlage</b>	H110 S210PD / Grade 2	S251PD / Grade 2	H153	S270PD	H180 S280
<b>ANSI</b>	F95	F97	F97		F98
	Thrown/retracted key upper lock outside/inside unit. Deadlocks when fully thrown. Latchbolt retracted knob/lever either side.	Thrown/retracted key upper lock outside/inside unit. Deadlocks when fully thrown. Inside lever retracts bolt/latch simultaneously.	Thrown/retracted key upper lock outside/ inside unit. Deadlocks when thrown. Deadlatch retracted key outer knob when pushing button inner knob. Inside knob retracts bolt/latch simultaneously.	Thrown/retracted key outside/ inside unit. Deadlocks when thrown. Outer lever locks/unlocks key only. Inside knob/lever retracts bolt/latch simultaneously.	Thrown/retracted key outside/ inside unit. Deadlocks when thrown. Outside knob/ lever fixed. Key only. Inside knob/lever retracts bolt/latch simultaneously.









# Mechanical lock functions

## ANSI A156.12, 1992 Interconnected locks (cont'd) ANSI A156.13, 1994, Series 1000 Mortise locks, non-keyed









								
<b>Schlage</b>	H185	S290	H170	L9010	L9040	L9044	L9440	L9444
<b>ANSI</b>	H185	S290	H170	L9010	L9040	L9044	L9440	L9444
	Thrown/retracted key upper lock from outside/inside unit. Deadlocks when thrown.	For one side. Used for door pull or matching trim.	Snap-on rose/knob. Concealed screws.	Retracted by knob/lever either side.	Retracted knob/lever either side unless outside locked by thumbturn. Turning inside knob/lever, closing door, or emergency turn unlocks outside.	Retracted knob/lever either side unless outside locked by thumbturn or coin turn. Turning inside knob/lever, closing door, rotating inside thumbturn, or outside coin turn unlocks outside.	Retracted knob/lever either side. Deadbolt operated by thumbturn. Turning inside knob/lever or emergency button unlocks outside.	Retracted knob/lever either side. Deadbolt operated by thumbturn or coin turn. Turning inside knob/lever or coin turn unlocks outside.

## ANSI A156.13, 1994, Series 1000 Mortise locks, non-keyed (cont'd)

## ANSI A156.13, 1994, Series 1000 mortise locks, keyed

									
<b>Schlage</b>	L0170	L0172	L9175	L9176	L9050 / Grade 1	L9056	L9060	L9066 x XL11-897	L9070 / Grade 1
<b>ANSI</b>	-	-	-	-	F04	-	F09	-	F05
	Knob/lever one side fixed. Includes lock chassis and arm or front.	Knob/lever both sides fixed by mounting bar.	Knob/lever one side fixed. Includes lock chassis and armor front.	Knob/lever both sides fixed. Includes lock chassis and arm or front.	Retracted knob/lever either side unless outside is made inoperative by key or thumbturn. Latchbolt retracted by knob/lever inside.	Retracted knob/lever either side unless outside operable by key/thumbturn. Inside knob/lever simultaneously retracts latchbolt/unlocks outside.	Retracted knob/lever either side unless outside locked by inside key. Unlocked by key outside or knob/lever inside.	Key in either cylinder locks or unlocks both levers. Specify XL11-897.	Retracted knob/lever either side unless outside locked by key. Inside always unlocked.

## ANSI A156.13, 1994, Series 1000 Mortise locks, keyed

								
<b>Schlage</b>	L9071 / Grade 1	L9076 / Grade 1	L9077 / Grade 1	L9080 / Grade 1	L9092EL/EU	L9095EL/EU	L9453 / Grade 1	L9456 / Grade 1
<b>ANSI</b>	-	F06	-	F07	-	-	F20	F13
	Retracted by knob/lever either side unless locked by key from either side. Unlocked by key outside or knob/lever inside.	Latchbolt operated knob/lever either side except when locked by key. Inside always unlocked. Holdback latch with key.	Retracted knob/lever either side unless locked by key. Unlocked by key outside or knob/lever inside. Either key holds back latch.	Latchbolt retracted key outside or knob/lever inside. Outside or knob/lever always inoperative. Auxiliary latch.	Outside knob/lever continuously locked (EL, aka Fail Safe) or unlocked (EU, aka Fail Secure) by 12 or 24V DC. Latchbolt retracted by key outside or knob/lever inside. Auxiliary latch. Request to Exit (RX) available.	Both knob/lever continuously locked (EL, aka Fail Safe) or unlocked (EU, aka Fail Secure) by 12 or 24V DC. Latchbolt retracted by key either side. Auxiliary latch. Request to Exit (RX) available.	Retracted knob/lever either side unless outside locked by 20° rotation of thumbturn. Deadbolt thrown or retracted by 90° rotation of thumbturn. Retracts deadbolt and latchbolt simultaneously. Auxiliary latch.	Retracted knob/lever either side. Deadbolt operated by key or inside thumbturn. Throwing deadbolt locks outside knob/lever. When locked, inside knob/lever simultaneously retracts deadbolt and latchbolt.



## Mechanical lock functions

### ANSI A156.13, 1994, Series 1000 Mortise locks, keyed (cont'd)

	<b>Security classroom with deadbolt</b>	<b>Classroom security lock with auxillary latch</b>	<b>Closet storage lock</b>	<b>Store/utility room lock</b>	<b>Dormitory/bedroom lock</b>	<b>Storeroom lock with deadbolt</b>
<b>Schlage</b>	L9457 / Grade 1	L9458	L9465	L9466† / Grade 1	L9473 / Grade 1	L9480
<b>ANSI</b>	F14	F34	-	F14	F21	-
	Latchbolt operated by knob/lever either side. Deadbolt projected and outside lever locked by key from either side. Inside knob/lever retracts deadbolt/latchbolt simultaneously.	Latchbolt operated by lever from either side except when outside lever is lock from inside or outside by key. Deadbolt retracted by key from inside or outside. Operating inside lever retracts both bolts and unlocks outside.	Auxiliary deadlatch when deadbolt is thrown. Inside lever is always free for immediate egress. Retracted knob/lever either side. Deadbolt extended or retracted by key outside.	Retracted knob/lever either side. Deadbolt extended or retracted by key either side.	Retracted knob/lever either side. Deadbolt extended or retracted by key outside or thumbturn inside.	Retracted key outside or knob/lever inside. Outside knob/lever always inoperative. Deadbolt operated by key outside/ thumbturn inside. When locked, inside knob/lever simultaneously retracts deadbolt and latchbolt.

### ANSI A156.13, 1994, Series 1000 Mortise locks, keyed (cont'd)

	<b>Hotel lock</b>	<b>Hotel lock DND indicator</b>	<b>Hotel lock occupied indicator</b>	<b>Privacy lock occupied indicator</b>	<b>Institution lock with deadbolt</b>	<b>Exit lock with deadbolt</b>
<b>Schlage</b>	L9485	L9486u / Grade 1	L9486 x L583-375	L9496	L9482	L9412
<b>ANSI</b>	-	F15	-	-	-	-
	Retracted key outside or knob/lever inside. Outside knob/lever always fixed. Deadbolt thrown or retracted inside thumbturn. Deadbolt thrown—“DO NOT DISTURB”—only operable by emergency keys. Inside knob/lever retracts deadbolt/latchbolt simultaneously. Auxiliary latch.	Retracted key outside or knob/lever inside. Outside knob/lever fixed. Deadbolt operated inside thumbturn. Deadbolt thrown—“DO NOT DISTURB”—only operable by emergency keys. Inside knob/lever simultaneously retracts deadbolt and latchbolt.	Retracted key outside or knob/lever inside. Outside knob/lever fixed. Deadbolt operated inside thumbturn. Deadbolt thrown—“OCCUPIED”—only operable by emergency keys. Inside knob/lever simultaneously retracts deadbolt and latchbolt.	Retracted knob/lever either side. Deadbolt by key outside/ thumbturn inside. Deadbolt thrown—“OCCUPIED”—locks outside knob/lever. Inside knob/lever simultaneously retracts deadbolt and latchbolt.	Latchbolt retracted by key from either side. Knob/lever on both sides always inoperative. Deadbolt thrown or retracted by key either side. Auxiliary latch deadlocks latchbolt when door is closed. Specify per XL11-543.	Latchbolt retracted by knob/lever inside. Outside knob/lever always fixed. Deadbolt thrown or retracted by inside thumbturn. Turning inside knob/lever retracts both deadbolt and latchbolt simultaneously. Auxiliary latch deadlocks latchbolt when door is closed. Specify per XL11-907.

### ANSI A156.13, 1994, Series 1000 Mortise locks, keyed deadlocks entrance handlesets

	<b>Cylinder x thumbturn</b>	<b>Storeroom lock with deadbolt</b>	<b>Hotel lock</b>	<b>Hotel lock DND indicator</b>	<b>Privacy lock occupied indicator</b>	<b>Institution lock with deadbolt</b>	<b>Exit lock with deadbolt</b>
<b>Schlage</b>	L9460 / Grade 1	L9462 / Grade 1	L9463	L9464 / Grade 1	F360	F362	F393
<b>ANSI</b>	F17	F16	-	F18	-	-	-
	Deadbolt thrown/ retracted key outside/ thumbturn inside.	Deadbolt operated by key either side.	Deadbolt thrown/ retracted by key outside. Inside cylinder turn retracts deadbolt but cannot project.	Deadbolt thrown/ retracted key one side. No trim on opposite side.	Deadbolt thrown or retracted by key from outside or by inside turn unit. Latch retracted by thumbpiece from outside or by inside knob/lever.	Deadbolt thrown or retracted by key from either side. Latch retracted by thumbpiece from outside or by inside knob/lever.	For use as door pull or as dummy trim on inactive leaf of pair of doors. Fixed thumbpiece and inside knob/lever. Dummy cylinder with inside plate.

#### Door handing:

Most Schlage locks are reversible. However, door hand should be specified for locks with lever designs to ensure that the correct finish is provided for latches and strikes on reverse beveled doors. Use the diagram to determine the hand of door.

Note: Not all locks are reversible. Please check price book listing for specifications.

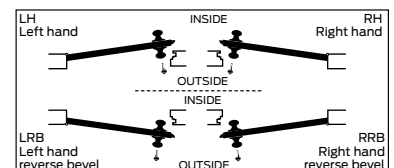

# Schlage Residential



## Contents

### Schlage

### Electronics

### Handlesets

### Lever

### Knobs

### Deadbolts

### Hardware & Accessories

### Multi-family

## Personal style, perfected.

For more than 95 years, Schlage has offered durable door hardware in a range of unique style combinations to express any personality. So welcome home. Welcome thousands of possibilities. Welcome style.



Easy

Quickly install Schlage products with just a Phillips screwdriver



Stylish

Choose from a range of lever, knob and trim styles to instantly elevate any room



Strong

Built with premium metal construction that adds strength, security and long life



Innovative

Products feature advanced technology to keep the state-of-the-art moving forward



Every day, made easier.

## Schlage Sense™

The Bluetooth®-enabled Schlage Sense™ Smart Deadbolt gives you easy accessibility and unparalleled control over access to your home. There's no need to memorize complex programming steps - just use the free Schlage Sense app to add and delete access codes right out of the box.

The lock also works with your iPhone®, iPad® or iPod touch®, so you can talk to unlock your door using Siri® when in Bluetooth range. And, with an Apple TV® within range of the lock, you can control the lock from anywhere using the Schlage Sense app.

### Easy to manage access

- Share and manage up to 30 access codes through the free Schlage Sense app, available in the Apple iTunes app store.
- Set access code schedules so the plumber or contractor can only enter at certain times
- See activity history of who is coming and going

### Easy installation

- No wiring needed – all you need is a screwdriver
- Guaranteed to fit on existing, standard pre-drilled doors

### Keyless convenience

- The Schlage Sense Smart Deadbolt works with Bluetooth Smart technology and your iPhone, iPad or iPod touch so you can use Siri when in range.
- When the Schlage Sense lock is placed near an Apple TV, you can use the Schlage Sense app to control your lock from anywhere. For best results, the lock should be within 40 feet of an Apple TV for remote capability.
- Apple HomeKit™ technology provides advanced security with end-to-end encryption and authentication between the Schlage Sense Smart Deadbolt and your iPhone, iPad or iPod touch.

### Finishes

Function	605	608	609	613	618	619	620	622	625	626	716
BE479AA Camelot											
BE479AA Century											

### Door preparation

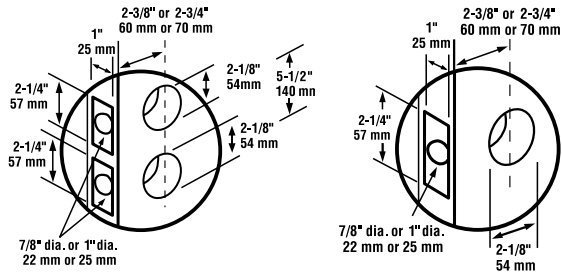

Apple TV, iPad, iPhone, iPod, iPod touch and Siri are trademarks of Apple Inc., registered in the U.S. and other countries. The Bluetooth word mark and logos are registered trademarks owned by Bluetooth SIG, Inc. and is licensed for use by Schlage. HomeKit is a trademark of Apple Inc. HomeKit requires an iPhone, iPad, or iPod touch with iOS 8.4 or later. Controlling HomeKit-enabled accessories away from home requires an Apple TV (3rd generation or later) with Apple TV software 7.0 or later.

# Home access anywhere.

## Schlage Connect™

The Schlage Connect™ Touchscreen Deadbolt with alarm combines advanced features and compatibility with your smart home or alarm system – allowing you to control your home from anywhere and freeing you from the hassles of lost keys, being locked out, or hiding a spare for friends and family.\*

### Connect with your lock, remotely

- Works with Z-Wave®-enabled smart home and alarm systems
- Lock/unlock and manage access codes from anywhere with your smartphone\*
- Illuminated fingerprint-resistant touchscreen holds up to 30 access codes so you can come and go without a key

### Built-in alarm technology senses potential door attacks

- Alarm functionality is easily customized to fit your security needs
- Meets the highest industry rating for security and durability

### Choose your own access codes

- Create and delete access codes remotely for visiting friends and family\*

\* Remote access requires a compatible home automation or security system. Features dependent on platform provider. For a complete listing of our partners, visit [schlage.com/partners](http://schlage.com/partners).

### Express your style

- Suites perfectly with our most popular trim styles to coordinate the look throughout your home
- Available in a variety of durable finishes to complement your home's style

### Easy installation

- Installs in minutes with a screwdriver - no wiring needed
- Guaranteed to fit on standard doors

### Finishes

Function	605	608	609	613	618	619	620	622	625	626	716
BE469 Camelot		•							•		•
BE469 Century										•	
BE468 Camelot		•							•		•
BE468 Century										•	•



BE469NX  
Camelot (CAM)



BE469NX  
Century (CEN)



BE468NX  
Camelot (CAM)



BE468NX  
Century (CEN)

### Door preparation

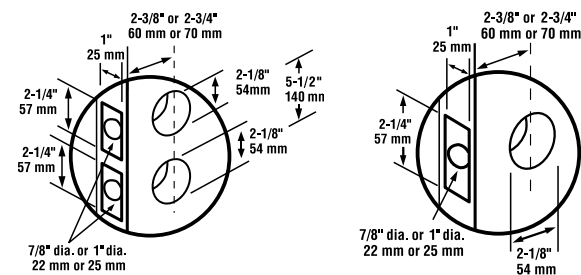



Keys, your number's up.

### Schlage Touch™

With the Schlage Touch™ Keyless Touchscreen lock, there's no keyhole for intruders to pick or bump, and no need to ever rekey. Just use the fingerprint-resistant touchscreen to enter with an access code – no key necessary. All in a slim profile that's every bit as sleek as it is strong.

#### No more keys to lose, hide, carry or forget

- No key needed: use a convenient access code
- Works in the rain and with gloves
- Eliminates need to re-key or cut new keys
- 2-year battery life with low battery icon and 9V battery backup

#### Slim profile without sacrificing strength

- Easily fits between front door and screen door
- Available in a variety of styles and finishes to complement your home
- Sleek lever options coordinate with interior hardware

#### Choose your own access codes

- Create and delete codes for visiting friends and family
- Memory for 19 access codes

#### Easy installation

- Installs in minutes with a screwdriver - no wiring needed
- Guaranteed to fit on standard doors

#### Finishes

Function	605	608	609	613	618	619	620	622	625	626	716
<b>BE375 Camelot</b>	•		•					•	•	•	•
<b>BE375 Century (CAM)</b>							•	•	•	•	•
<b>FE695 Accent</b>	•		•				•	•	•	•	•
<b>FE695 Accent (CEN) Century</b>	•		•							•	•
<b>FE695 Broadway</b>							•	•	•	•	•
<b>FE695 Elan</b>										•	
<b>FE695 Latitude</b>							•	•	•	•	•
<b>FE695 Merano</b>							•	•	•	•	•

#### Door preparation

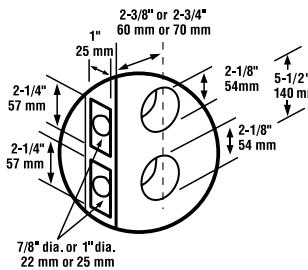

#### Door Preparation

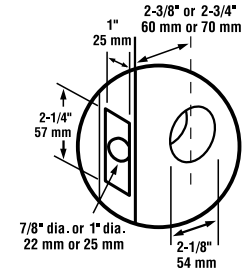

#### Schlage Touch™ deadbolts



BE375 Camelot (CAM)



BE375 Century (CEN)

#### Schlage Touch™ levers



FE695 Camelot x Accent (CAM) (ACC)



FE695 Camelot x Flair (CAM) (FLA)



FE695 Century x Broadway (CEN) (BRW)



FE695 Century x Latitude (CEN) (LAT)



FE695 Century x Merano (CEN) (MER)



# Code or key. You decide.

## Keypad locks

Say goodbye to lost, stolen and just plain forgotten keys. With an easy-to-install Schlage keypad, coming and going is keyless, effortless – and painless.

### Keyless option makes sharing access easier and more secure

- Back-lit keypad
- Silicone-coated keypad prevents numbers from wearing off
- Ideal for: front door, garage door, home office, wine cellar or utility closet
- Low battery indicator

### Choose your own access codes

- Create and delete codes for visiting friends and family
- Memory for 19 access codes

### Express your style

- Available in a variety of durable finishes to complement your home's style
- Sleek knob and lever options coordinate with interior hardware

### Easy installation

- Installs in minutes with a screwdriver - no wiring needed
- Guaranteed to fit on standard doors

### Finishes

**BE and FE Series 605 608 609 613 618 619 620 622 625 626 716**

BE365 Camelot	▪	▪	▪	▪	▪	▪	▪	▪	▪	▪	▪
BE365 Plymouth	▪	▪	▪	▪	▪	▪	▪	▪	▪	▪	▪
FE595 Camelot x Accent	▪	▪	▪	▪	▪	▪	▪	▪	▪	▪	▪
FE595 Camelot x Georgian	▪	▪	▪	▪	▪	▪	▪	▪	▪	▪	▪
FE595 Plymouth x Flair	▪	▪	▪	▪	▪	▪	▪	▪	▪	▪	▪
FE595 Plymouth x Plymouth	▪	▪	▪	▪	▪	▪	▪	▪	▪	▪	▪
FE575 Camelot x Accent	▪	▪	▪	▪	▪	▪	▪	▪	▪	▪	▪
FE575 Plymouth x Flair	▪	▪	▪	▪	▪	▪	▪	▪	▪	▪	▪
FE575 Plymouth x Elan	▪	▪	▪	▪	▪	▪	▪	▪	▪	▪	▪
FE575 Plymouth x Jazz	▪	▪	▪	▪	▪	▪	▪	▪	▪	▪	▪
FE575 Plymouth x Plymouth	▪	▪	▪	▪	▪	▪	▪	▪	▪	▪	▪

### Door preparation

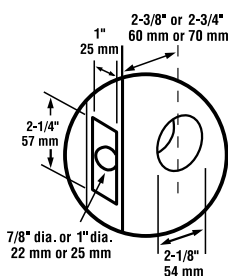

## Keypad deadbolts



## Keypad levers with Flex-lock



## Keypad levers with Auto-lock

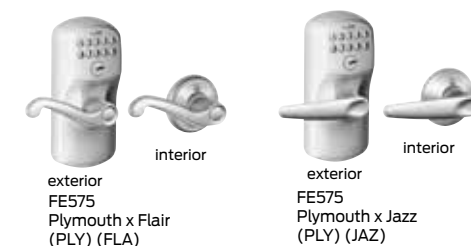



## Electronic Specifications

### BE479 Specifications

<b>Certification</b>	ANSI A156.36-2010 Grade 1
<b>Product dimensions (w x h x d)</b>	Exterior: 3" x 4-3/4" x 7/8" (76mm x 121mm x 22mm) Interior: 3" x 8-1/5" x 2-1/10" (76mm x 208mm x 54mm)
<b>Weight</b>	3.5 lbs. (1.6kg)
<b>Warranty</b>	Limited three-year electronics; limited lifetime mechanical and finish
<b>Batteries required</b>	Yes
<b>Batteries included</b>	Yes
<b>Type of battery</b>	AA
<b>Number of batteries required</b>	4
<b>Battery life (hours)</b>	8,760
<b>Deadbolt throw</b>	1" (25mm)
<b>Key &amp; cylinder</b>	1 key, 5-pin C keyway
<b>Door thickness range</b>	1-3/8" to 1-3/4" (35mm to 44mm)
<b>Cross bore diameter</b>	2-1/8" (54mm) or 1-1/2" (38mm)
<b>Edge bore diameter</b>	1" (25mm)
<b>Backset</b>	Adjusts to 2-3/8" (60mm) or 2-3/4" (70mm)
<b>Latch faceplate size</b>	1" x 2-1/4" (25mm x 57mm)
<b>Latch faceplate options</b>	Round corner, square corner, and drive-in (triple option standard)
<b>Strike</b>	Round corner strike 1-1/8" x 2-3/4" (29mm x 70mm) with reinforcer
<b>ADA compliant</b>	No
<b>Codes</b>	2 pre-set unique four-digit user codes, storage of up to 30 user codes
<b>Communications</b>	Apple HomeKit™, Bluetooth® Smart technology
<b>Homekit™ compatibility</b>	HomeKit™ requires an iPhone®, iPad®, or iPod touch® with iOS 8.4 or later
<b>Remote access</b>	Controlling HomeKit-enabled accessories away from home requires an Apple TV® (3rd generation or later with Apple TV® software 7.0 or later and an iPhone®, iPad® or iPod touch® with iOS 8.4 or later)
<b>Alarm</b>	Built-in alarm to detect activity or forced entry with selectable sensitivity
<b>Mobile app</b>	Free mobile app available for iPhone®, iPad® and iPod touch®.
<b>Operating temperatures</b>	Outside lock body (exterior mounted): -35C to 66C Inside lock body (interior mounted): -10C to 50C

### BE469NX Specifications

<b>Certification</b>	ANSI A156.36-2010 Grade 1
<b>Warranty</b>	3 year electronics, limited lifetime mechanical and finish
<b>Backset</b>	2 3/8" or 2 3/4"
<b>Strike</b>	1 1/8" x 2 3/4" round corners, strike reinforcer
<b>Key &amp; cylinder</b>	1 key, 5-pin, C keyway
<b>Door thickness</b>	1 3/8" to 1 3/4"; thick door kit extends 1 7/8" to 2 1/2"
<b>Product dimensions (w x h x d)</b>	ext: 3" x 4 3/4" x 1" int: 3" x 8" x 2"
<b>Communications</b>	900 MHz (Z-Wave® RF)**
<b>Operating temps</b>	Ext: -35C to 66C Int: -10C to 49C
<b>Battery</b>	4 AA
<b>Codes</b>	Pre-set, unique 6-digit programming code, 2 pre-set unique 4-digit user codes, 30 user code capacity (4-8 digits)

\*\* Z-Wave is a registered trademark of Zensys Inc, and/or its subsidiaries.

### BE369NX Specifications

<b>Certification</b>	ANSI A156.36-2010 Grade 2
<b>Warranty</b>	3 year electronics, limited lifetime mechanical and finish
<b>Backset</b>	2 3/8" or 2 3/4"
<b>Strike</b>	1 1/8" x 2 3/4" round corners, strike reinforcer
<b>Key &amp; cylinder</b>	2 keys, 5-pin, C keyway
<b>Door thickness</b>	1 3/8" to 1 3/4"
<b>Product dimensions (w x h x d)</b>	ext: 3 1/8" x 5 1/2" x 2 1/8" int: 3 1/4" x 7 1/2" x 2 1/4"
<b>Communications</b>	900 MHz (Z-Wave® RF)**
<b>Operating temps</b>	Ext: -30C to 66C Int: -10C to 49C
<b>Battery</b>	9V, 3AA
<b>Codes</b>	Pre-set, unique 6-digit programming code, 2 pre-set unique 4-digit user codes, 19 code capacity

\*\* Z-Wave is a registered trademark of Zensys Inc, and/or its subsidiaries.

### FE599NX Specifications

<b>Certification</b>	ANSI A156.2-2003 Grade 2
<b>Warranty</b>	3 year electronics, limited lifetime mechanical and finish
<b>Backset</b>	2 3/8" or 2 3/4"
<b>Strike</b>	1 5/8" x 2 1/4" radius corner, full lip, latch strike
<b>Key &amp; cylinder</b>	2 keys, 5-pin, C keyway
<b>Door thickness</b>	1 3/8" to 1 3/4"
<b>Product dimensions (w x h x d)</b>	ext: 6 7/8" x 3" x 2 3/4" int: 3 1/4" x 8 1/4" x 2 3/4"
<b>Communications</b>	900 MHz (Z-Wave® RF)**
<b>Operating temps</b>	Ext: -30C to 66C Int: -10C to 49C
<b>Battery</b>	9V, 4AA
<b>Codes</b>	Pre-set, unique 6-digit programming code, 2 pre-set unique 4-digit user codes, 19 code capacity

\*\* Z-Wave is a registered trademark of Zensys Inc, and/or its subsidiaries.

### BE365 Specifications

<b>Application</b>	Residential single- and multi-family doors
<b>Keying</b>	5-pin tumbler with two keys per lock; stock locks are keyed 5-pin
<b>Door range</b>	1 3/8" to 1 3/4" thick (35mm - 44mm) standard; thick door kit available on BE365
<b>Backset</b>	Universal latches and deadbolts fit 2 3/8" (60 mm) or 2 3/4" (70 mm) backsets
<b>Warranty</b>	3 year electronics, limited lifetime mechanical and finish

### FE575 & FE595 Specifications

<b>Warranty</b>	Limited lifetime mechanical and finish warranty, 3 year electronics warranty
<b>Keypad lock latch</b>	1" x 2 1/4" (25mm x 57mm) latch with radius corner faceplate, 7/8" (22mm) housing diameter, 1/2" (13mm) throw spring latch with square corner and circular drive-in faceplates
<b>Keypad deadbolt latch</b>	1" x 2 1/4" (25mm x 57mm) radius corner faceplate, 1" (25mm) housing diameter, requires 1" (25mm) edge bore, 1" (25mm) throw with square corner and circular drive-in faceplates
<b>Latch strikes</b>	1 5/8" x 2 1/4" (41mm x 57mm), square and radius corner, full lip
<b>Deadbolt strike</b>	2 3/4" (70mm), round corner, latch strike, metal strike reinforcer
<b>Cylinder</b>	5-pin solid brass, keyed 5-pin, C keyway, keyed different (KD)

A new way in.

### Handlesets F Series

Your front door is more than just a secured entrance, it's also a showpiece – one of the first things a guest sees. That's why it's important to choose the right handleset. Schlage offers a wide variety of designs and finishes, from angular to flowing, classic to contemporary, all designed to ensure that your front door is the perfect introduction to your home.

#### Express your style

- Available in a variety of unique finishes to complement your home's style
- Decorative trim options add the perfect finishing touch
- Choose from a wide range of interior knob and lever styles

#### Proven quality & durability

- Designed for strength and durability
- Larger, solid 1-inch bolt
- Stronger, durable finish meets all industry requirements backed by a limited lifetime warranty\*
- Highest residential security rating

#### Easy installation

- Installs in minutes with a screwdriver
- Adjustable pieces guarantee fit on standard doors
- Simple 3-step deadbolt assembly

\*See the product warranty for full details

#### Finishes

Handlesets	605	608	609	613	618	619	620	621	622	625	626	716
Addison	.	.	.	.	.	.	.	.	.	.	.	.
Brookshire	.	.	.	.	.	.	.	.	.	.	.	.
Camelot	.	.	.	.	.	.	.	.	.	.	.	.
Century	.	.	.	.	.	.	.	.	.	.	.	.
Greenwich	.	.	.	.	.	.	.	.	.	.	.	.
Plymouth	.	.	.	.	.	.	.	.	.	.	.	.
Wakefield	.	.	.	.	.	.	.	.	.	.	.	.

#### Door preparation

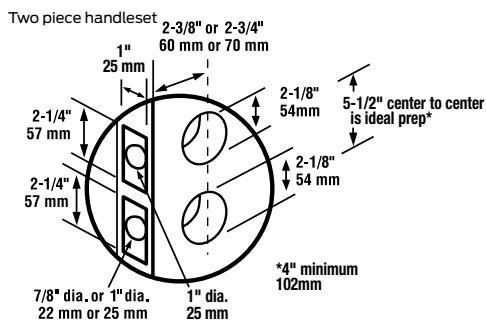

#### F58 Available Exterior Styles

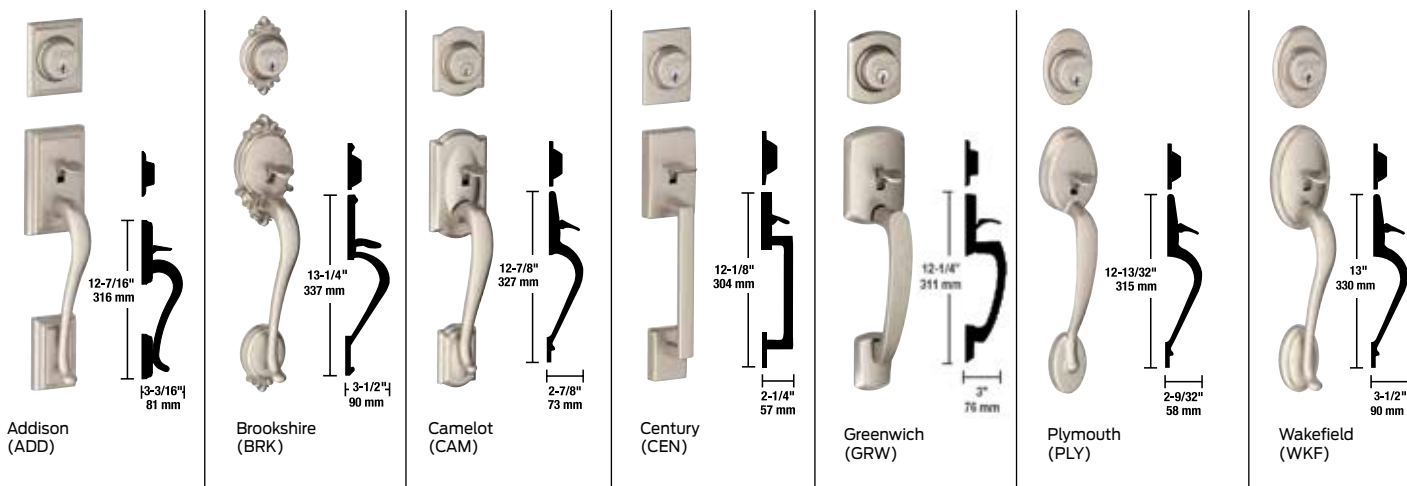



What goes in, keeps them out.

### Deadbolts B Series

With premium metal construction and plated keyways, Schlage deadbolts are made with durability in mind. Combine our wide range of unique finish and style with our easy one-tool installation and you can give your door a stylish makeover in minutes.

#### Express your style

- Available in a variety of durable finishes to complement your home's style
- Decorative trim options add the perfect finishing touch

#### Proven quality & durability

- Designed for strength and durability
- Larger, solid 1-inch bolt
- One-piece exterior protects against prying with sharp objects
- Highest residential security rating
- Contains anti-drill pins and plates to help prevent intruders from drilling out lock

#### Easy installation

- Installs in minutes with a screwdriver
- Guaranteed to fit on standard doors



B60



B62

#### Finishes

Series	605 606 609 612 613 619 620 621 622 625 626 643/716												
	505	US3	US4	US5	US10	US10B	US15	US15A	US17A	US19	US26	US26D	US11
B60	■	■		■		■	■	■	■	■	■	■	716
B62	■	■					■					■	716

Complete finish chart on page 52

#### Specifications

<b>Certifications</b>	Exceeds ANSI/BHMA certified A156.5 - 2001, Grade 1, UL Listed for 3-hour fire door (Grade 2 with FSIC)
<b>Applications</b>	Medium-traffic deadbolt, Grade 1 residential or commercial, exterior, new construction and retrofit applications
<b>Deadbolt</b>	1" x 2 1/4" (25mm x 57mm), square and round corner faceplate included, 1" (25mm) housing diameter, 1" (25mm) throw

#### Door preparation

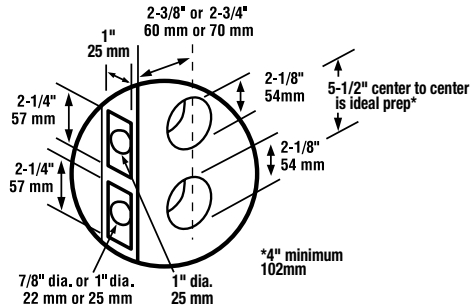

Style is in the details.

### Knobs & levers F Series

Schlage believes that the “finishing touch” is just as important as the first. Which is why we make distinctive door hardware designed not just to match your personal style, but to welcome you home. From classic looks that never go out of style to bold contemporary designs, our knobs and levers fit and accentuate virtually any décor – and, with multiple functions available, any door.

#### Proven quality & durability

- Highest residential security rating
- Safe and Easy Exit keyed entry lock unlocks when the door is opened from the inside, allowing you to leave quickly and conveniently, and re-enter easily
- Limited lifetime finish and mechanical guarantee\*

#### Easy installation

- Guaranteed to fit on standard doors
- Installs in minutes with a screwdriver
- Reversible levers available
- Self-guiding screws align and snap themselves into place
- Universal latches slide easily into place, requiring no additional tools or manual adjustments

\*See the product warranty for full details

#### Specifications

<b>Applications</b>	Residential single-family and multi-family use
<b>Certifications</b>	ANSI A156.2, 1996, Series 4000 Grade 2. UL Listed locks for 3-hour fire doors are furnished with #10-001 T strike, 1 1/8" x 2 3/4" (29mm x 70mm), 1 1/8" (29mm) lip (also available with standard product). Assembled to order when specified with "F" suffix. Example: F51F
<b>Exposed trim</b>	Levers are plated to match finishes indicated.
<b>Keying</b>	5-pin tumbler C keyway with two keys. All F51A functions offer interior emergency exit feature.
<b>Door range</b>	1 3/8" to 1 3/4" (35mm to 44mm) standard.
<b>Backset</b>	Fits either 2 3/8" (60mm) or 2 3/4" (70mm) backset.

#### Door preparation

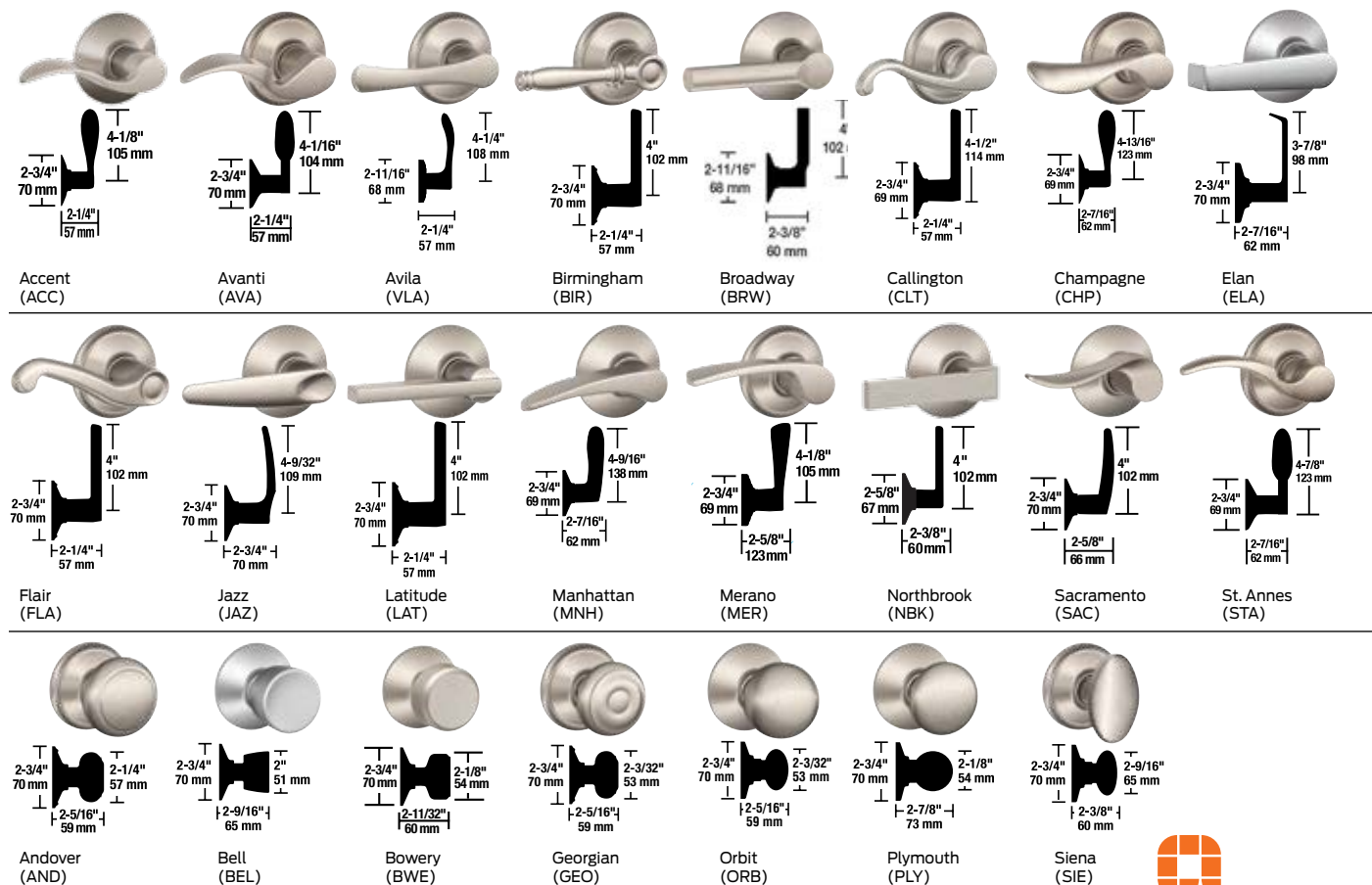
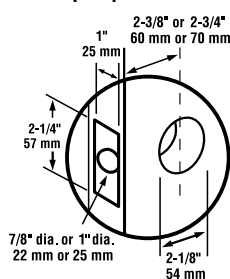

Stand out effortlessly.

### Decorative trim

Schlage's Decorative Collections make it easy to match our strength to your style. With more than 1,000 customized design and finish options in all, your decor will be limited by only your imagination.



Pair a knob or lever with our inspired decorative trim options to bring your vision to life.\*

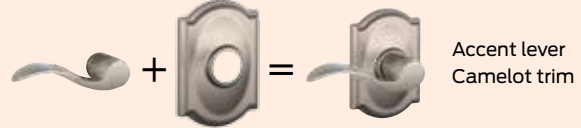

\* Locks ship complete with trim attached

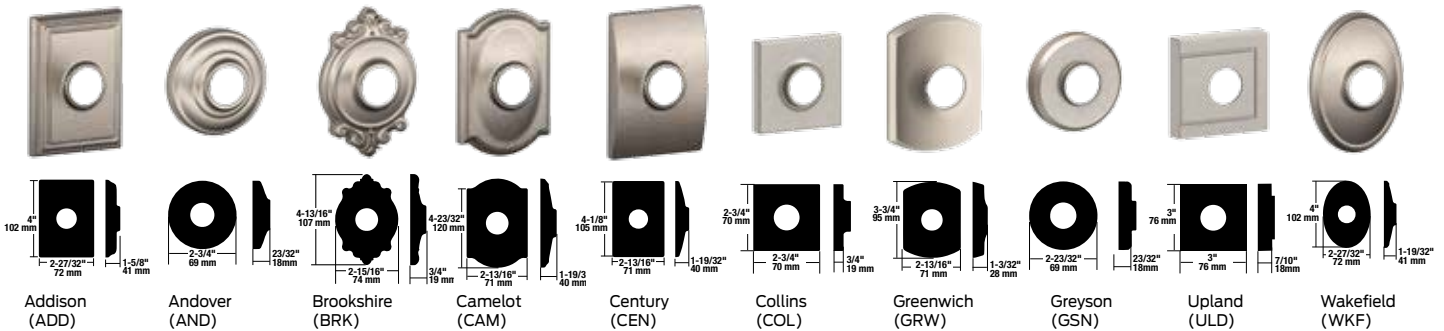

### Finishes

Knobs & Levers	605	608	609	618	619	625	626	505	716	613	620	621	622
Addison (ADD)	■	■	■	■	■	■	■	■	■	■	■	■	■
Brookshire (BRK)	■	■	■	■	■	■	■	■	■	■	■	■	■
Camelot (CAM)	■	■	■	■	■	■	■	■	■	■	■	■	■
Century (CE)	■	■	■	■	■	■	■	■	■	■	■	■	■
Collins (COL)	■	■	■	■	■	■	■	■	■	■	■	■	■
Greenwich (GRW)	■	■	■	■	■	■	■	■	■	■	■	■	■
Wakefield (WKF)	■	■	■	■	■	■	■	■	■	■	■	■	■
Upland (ULD)	■	■	■	■	■	■	■	■	■	■	■	■	■
Andover (AD)*	■	■	■	■	■	■	■	■	■	■	■	■	■
Greyson (GS)*	■	■	■	■	■	■	■	■	■	■	■	■	■

Handlesets F59 & F94 only	605	608	609	618	619	625	626	505	716	613	620	621	622
Addison (ADD)	■	■	■	■	■	■	■	■	■	■	■	■	■
Andover (AD)*	■	■	■	■	■	■	■	■	■	■	■	■	■
Brookshire (BRK)	■	■	■	■	■	■	■	■	■	■	■	■	■
Camelot (CAM)	■	■	■	■	■	■	■	■	■	■	■	■	■
Century (CE)	■	■	■	■	■	■	■	■	■	■	■	■	■
Greenwich (GRW)	■	■	■	■	■	■	■	■	■	■	■	■	■
Wakefield (WKF)	■	■	■	■	■	■	■	■	■	■	■	■	■
Greyson (GS)*	■	■	■	■	■	■	■	■	■	■	■	■	■
Upland (ULD)*, **	■	■	■	■	■	■	■	■	■	■	■	■	■
Collins (COL)**	■	■	■	■	■	■	■	■	■	■	■	■	■

Deadbolts	605	608	609	618	619	625	626	505	716	613	620	621	622
Addison (ADD)	■	■	■	■	■	■	■	■	■	■	■	■	■
Brookshire (BRK)	■	■	■	■	■	■	■	■	■	■	■	■	■
Camelot (CAM)	■	■	■	■	■	■	■	■	■	■	■	■	■
Century (CE)	■	■	■	■	■	■	■	■	■	■	■	■	■
Collins (COL)	■	■	■	■	■	■	■	■	■	■	■	■	■
Greenwich (GRW)	■	■	■	■	■	■	■	■	■	■	■	■	■
Wakefield (WKF)	■	■	■	■	■	■	■	■	■	■	■	■	■

\* Andover, Greyson, and Upland trim available on interior knob or lever only and not on the deadbolt  
 \*\* Upland F59 and F94 features Collins deadbolt

### Door preparation

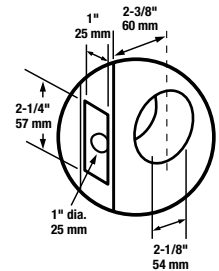

# Form vs. Function. We're not taking sides.

## J Series Grade 3

Inspired design. Proven security. Schlage® J Series door hardware performs without compromise at a price that won't compromise your budget.

### Proven quality & durability

- Security rated for residential use
- Schlage keyway standard
- Limited lifetime mechanical and 5-year finish warranties\*
- Reversible levers
- Deadbolt fits standard 2 1/8" door prep only
- Installs in minutes with a screwdriver

\*See the product warranty for full details



JD60

JD80 one-sided deadbolt

JD81 one-sided deadbolt w/ exterior plate

### Finishes

Handlesets	605	608	609	618	619	620	622	625	630	716
Barcelona	▪	▪	▪	▪	▪	▪	▪	▪	▪	▪
Paris	▪	▪	▪	▪	▪	▪	▪	▪	▪	▪
Deadbolts										
JD60	▪	▪	▪	▪	▪	▪	▪	▪	▪	▪
JD80	▪	▪	▪	▪	▪	▪	▪	▪	▪	▪
JD81	▪	▪	▪	▪	▪	▪	▪	▪	▪	▪

\*Discontinued; available while supplies last

### Deadbolt specifications

Applications	Residential single-family and multi-family use
Certification	ANSI A156.5, 2001 Grade 3.
Exposed trim	Wrought brass or bronze.
Keying	Schlage C keyway with two brass keys. Locks are keyed 5-pin.
Door range	1 3/8" to 1 3/4" (35mm to 44mm) standard.
Backset	Universal latch standard, fits either 2 3/8" (60mm) or 2 3/4" (70mm) backsets.
Warranty	Limited lifetime mechanical warranty, five-year finish warranty.
UL listing	Single cylinder deadbolt product available with UL Listing - box pack only.

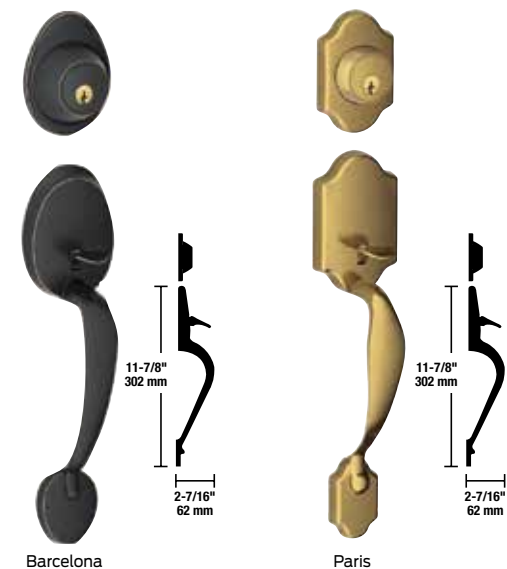

Barcelona

Paris

### Door preparation

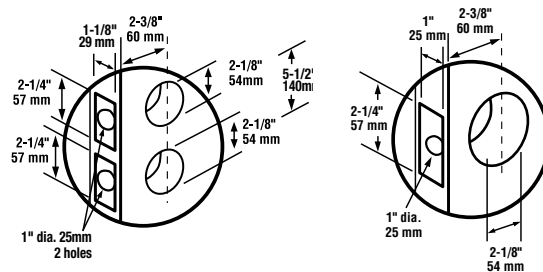

### Handleset specifications

Applications	Residential single-family and multi-family use
Certifications	ANSI A156.5, 2001, Grade 3.
Exposed trim	Handlesets are zinc-based; plated to match finishes indicated.
Keying	Schlage C keyway with two brass keys. Locks are keyed 5-pin.
Door range	1 3/8" to 1 3/4" (35mm to 44mm) standard.
Backset	Universal latch standard, fits either 2 3/8" (60mm) or 2 3/4" (70mm) backsets.
Warranty	Limited lifetime mechanical warranty, five-year finish warranty.
UL listing	Single cylinder deadbolt/handleset available with UL Listing - box pack only.

## J Series Grade 3

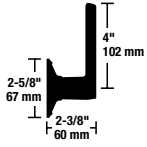

Solstice

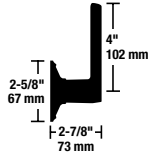

Torino

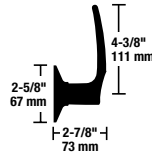

Dover

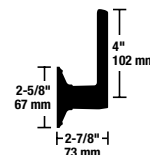

LaSalle

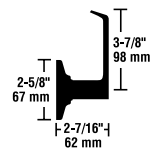

Marin

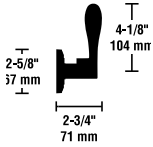

Seville

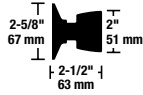

Byron

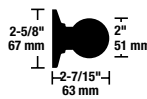

Corona

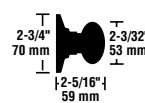

Stratus

## Finishes

Knobs	605	609	619	620	625	626	630	716
Byron	.	.	.	.	.	.	.	.
Corona	.	.	.	.	.	.	.	.
Stratus	.	.	.	.	.	.	.	.
Levers								
Dover	.	●	.	.	.	.	.	.
LaSalle	.	.	.	.	.	.	.	.
Marin	.	.	.	.	.	.	.	.
Torino	.	.	.	●	.	.	.	.
Seville	.	.	.	.	.	.	.	.
Solstice	.	.	.	.	.	.	.	.

● Discontinued; available while supplies last

## Door preparation

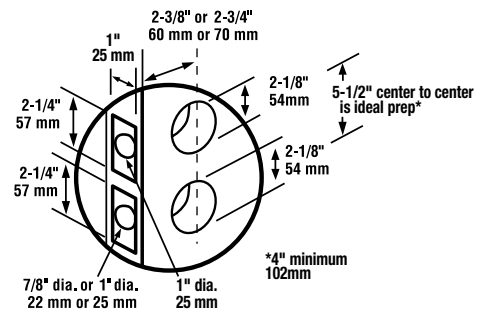

## Specifications

Applications	Residential single-family and multi-family use
Certifications	ANSI A156.2, 1996, Series 4000 Grade 3
Exposed trim	Levers are zinc-based; plated to match finishes indicated. Knobs are brass or stainless steel; plated to match finishes indicated
Keying	5-pin tumbler Schlage C keyway with two brass keys
Door range	1 3/8" to 1 3/4" (35mm to 44mm) standard
Backset	Universal latch standard, fits either 2 3/8" (60mm) or 2 3/4" (70mm) backsets
UL listing	Knobs/levers available with UL listing. Box pack only



## Hardware & accessories

### Interior hardware



#### 61 Solid door stop

- Made from aluminum or brass
- Projection: 3<sup>3</sup>/<sub>16</sub>" on aluminum units
- Finishes: A3, A5, A15, A14, A26D, A716, A-W, US3, US5, US15, US26, US26D, US716



#### 63 Flex door stop

- Made from steel
- Projection: 3"
- Finishes: F3, F5, F15, F26D, F716, US3, US5, US15, US26D, US716



#### 221 Flush pull

- Made from wrought brass
- Inside cup diameter: 2<sup>1</sup>/<sub>8</sub>"; overall diameter: 2<sup>7</sup>/<sub>16</sub>" depth: 7/<sub>16</sub>"
- Finishes: B3, B716, B5, B14, B15, US3, US716 US5, US14, US15



#### 262 and 265 manual flush bolt

- Made from solid brass
- Dimension: 6" x 3/<sub>4</sub>"
- Finishes: B3, B5, B26, B26D, B716, US3, US5, US26, US26D, US716

### Exterior hardware



#### U700 Eye viewer

- 120° angle of view
- For doors 1<sup>3</sup>/<sub>8</sub>" to 2<sup>1</sup>/<sub>16</sub>" thick
- UL Listed for use on fire door assemblies rated at 90 minutes
- Finishes: B4, B26D, B10B, US4, US26D, US10B



#### U698 Eye viewer

- 190° angle of view
- For doors 1<sup>3</sup>/<sub>8</sub>" to 2<sup>1</sup>/<sub>8</sub>" thick
- U698 is UL Listed for use on fire door assemblies rated at 90 minutes
- Finishes: B3, B26, B10B, US3, US26, US10B

#### 8400 — Residential grade kick plates

- .037 gauge



#### Finishes

PA3  
PA619  
PA28  
PA716

#### Sizes

6" x 30", 6" x 34", 8" x 34"  
6" x 30", 6" x 34", 8" x 34"  
6" x 30", 6" x 34", 8" x 34"  
6" x 30", 6" x 34", 8" x 34"



#### 601/620 Mail slots

- 11" x 2" opening
- Finishes: B3, B5, 626, B15, B26, B716, PA28, US3, US5, US26D, US15, US26, US716, US28

## Hardware & accessories



### 059 Hand rail bracket

- Made from aluminum
- Base: 2 1/4" x 1 3/8"
- Finishes: A3, A5, A14, A15, A26D, A716, US3, US5, US15, US26, US26D, US716



### 59 Hand rail bracket

- Made from aluminum
- Brass base: 2 15/16" x 1 1/2"
- Finishes: A3, A5, A14, A15, A26D, A716, US3, US5, US15, US26, US26D, US716



### 436 Floor door stop

- Made from brass or aluminum
- Oval 1 3/4" x 2"
- Finishes: B3, B5, B15, B26, B26D, B716, PA3, PA5, PA14, PA15, PA92, PA716, US3, US5, US15, US26, US26D, US716



### 70 Hinge pin door stop

- Made from aluminum
- Removable bushings accommodate 1/4" to 5/16" diameter hinge pins
- Finishes: A3, A5, A15, A26, A26D, A716, AW, US3, US5, US15, US26, US26D, US716



### 07 Window lock

- Made from solid brass or aluminum
- Base: 1 5/16" x 2 9/16"
- Strike: 5/8" x 2 9/16"
- Finishes: aluminum-A3, A5, A14, A15, A92, AW, US3, US5, US15, US26, US26D, US716



### 026 Bar window lift

- Made from aluminum
- Base: 1 1/8" x 4"
- Finishes: B10B, B14, B15, aluminum-A3, A5, A14, A92, A5, A-716, US3, US5, US15, US26, US26D, US716



### 481 Door guard chain

- Made from brass or steel
- Meets design requirements of ANSI/BHMA A156.16
- Finishes: brass F26, F26D, F716, US3, US5, US15, US26, US26D, US716



### 990 Sliding door pull

- Made from aluminum or steel
- Doors 1 3/8" to 1 1/2"
- Size 1 3/4" x 2 1/4"
- Finishes: A3, A5, A15, A14, A92, A-716, F3, F5, F14, F92, F-716, US3, US5, US15, US26, US26D, US716



### 580 Ceiling hook

- Made from aluminum
- Base: 7/8" x 1 15/16, 2 1/4" projection
- Finishes: A3, A5, A14, A15, A26, A26D, A716, US3, US5, US15, US26, US26D, US716



### 581 Single wardrobe hook

- Made from aluminum
- Base: 1 1/4" x 1/8", 1 5/8" projection
- Finishes: A3, A5, A14, A15, A26, A26D, A716, US3, US5, US15, US26, US26D, US716



### 582 Double wardrobe hook

- Made from aluminum
- Base: 1 1/16" x 1 1/4, 1 3/32" projection
- Finishes: A3, A5, A14, A15, A26, A26D, A716, US3, US5, US15, US26, US26D, US716



### 991 Sliding door lock

- Made from aluminum or steel
- Doors: 1 3/8" to 1 1/2"
- Size: 1 3/4" x 2 1/4"
- Strike: 1" x 2 1/4"
- Finishes: A3, A5, A15, A14, A92, A-716, F3, F5, F14, F92, F-716, , US3, US5, US15, US26, US26D, US716

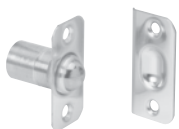

### 347 Ball catch

- Made from wrought brass
- Face plate: 2 1/8" x 1"
- Strike: 2 1/8" x 1 1/16"
- Finishes: B3, B5, B15, B26, B26D, B716, US3, US5, US15, US26, US26D, US716

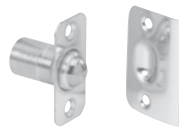

### 349 Ball catch

- Made from wrought brass
- Face plate: 2 1/8" x 1"
- Strike: 2 1/8" x 1 3/8"
- Finishes: B3, B5, B15, B26, B26D, B716, US3, US5, US15, US26, US26D, US716



### WS407CVX Wall guard

- Made from wrought brass
- Convex rubber bumper
- Finishes: US3, US4, US5, US10, US10B, US14, US15, US26, US26D, US28, US32D



### WS407CCV Wall guard

- Made from wrought brass
- Concave rubber bumper
- Finishes: US3, US4, US5, US10, US10B, US14, US15, US26, US26D, US28, US32D

# The next generation of access is here.

## Multi-family

Schlage Control™ Smart Locks are engineered and manufactured expressly to work on multi-family properties. The open integration capabilities, in conjunction with ENGAGE™ Technology, offers flexible, streamlined control and the freedom to integrate with alliance software partners to manage a wide spectrum of facility needs. From the start, they'll make things simple.

### Improves security & safety, reduces liability

- No-cylinder design makes locks 100% pick and bump proof
- Designed for accessibility using smart credentials and/or smartphone

### Increases efficiency of property operations

- Eliminates cost and hassle of managing of keys
- No-tour functionality (altering access to a lock without having to visit it)

### Maximize return on investment

- Smart credentials eliminate lock rekeying costs
- Upgrades property visual appeal

### Easy installation

- No wiring or modifications of door frames required
- Ideal for both new construction and retrofits

### Specifications

Latch	1" x 2-1/4" square and round corner faceplate (square corner standard, round corner included in package) 1" edge bore required
Strikes	1-1/8" x 2-3/4", square corner, no box, latch strike
Backset	Adjustable backset, fits 2-3/8" to 2-3/4" backsets
Door range	1-3/8" to 1-3/4" (thick door kit available - up to 2-1/4")
Battery	4-AA batteries included, (If loss of battery power occurs, a 9V battery can be used to jump start the lock and provide access with an assigned credential.)
Construction	All-metal chassis and escutcheons
Bore	2-1/8"
Credential	Supports aptiQ MIFARE classic, aptiQ DESFire
Stile width	Minimum 4-1/2" stile for 2-3/8" backset, minimum 5" stile for 2-3/4"
Return to door	Saturn (SAT) and Neptune (NEP) are return to door code compliant
Center to center	Fits 4" or 5-1/2" center to center door preps -orderable options (Please specify when ordering)
Certifications	90 minute UL Listed A 156.12 Grade 2 ANSI/BHMA certified

### Interconnect deco trim

Addison (ADD) or Greenwich (GRW) supplied standard depending on style ordered

### Interconnect lever styles

Accent, Avila, Birmingham, Broadway, Elan, Jazz, Jupiter, Latitude, Manhattan, Neptune, Northbrook, Sacramento, Saturn



Schlage Control™ Smart Deadbolt Lock with Greenwich trim in Satin Nickel with Broadway Lever (lever sold separately)

Schlage Control Smart Deadbolt Lock with Addison trim in Satin Nickel with Accent lever (lever sold separately)



Schlage Control Smart Interconnect Lock with Greenwich trim in Satin Nickel with Broadway Lever

Schlage Control Smart Interconnect Lock with Addison trim in Satin Nickel with Accent Lever

### Finishes

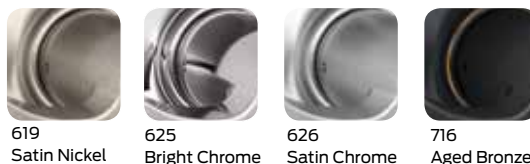

### Door preparation

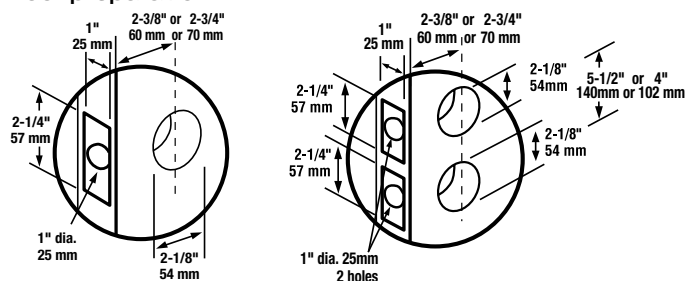



## Multi-family readers and credentials

All the tools you need to manage every opening in your building.



### Credential readers

- Accommodates interior, exterior, metal and metal installation environments
- Recognizes most proximity credentials, magnetic stripe, proximity, and smart credentials including aptiQ MIFARE Classic and MIFARE DESFire EV1 credentials
- FIPS 201-1 compliant
- NFC compatible
- Quick-connect wiring harness for easy installation
- Simple wiring - color scheme is identical to most readers
- Easy-to-install mounting bracket
- Tri-state LED
- Wiegand output
- Multiple reader cover color options
- Limited lifetime warranty



### Credentials

- User/resident credentials
  - Over three billion code combinations
  - Cannot be duplicated
- Programming credentials
  - Required for lock programming
- Construction credentials
  - Used during construction; operates all electronic locks that haven't been programmed
- Vendor credentials
  - Used to allow temporary access to employees and vendors in conjunction with the Schlage vendor access management system software with Schlage access software

### IBF-110

- Proximity Keyfob
  - 125 KHz proximity technology
- iButton
  - Durable stainless-steel packaging
  - Unique factory programmed 64-bit registration number
  - Momentary contact initiates identification
  - Data transfer rate of up to 16.3kbps

### IBF-120

- Proximity Keyfob
  - 125 KHz proximity technology
- iButton
  - The iButton credential is a read-write credential
  - When used with a preferred third-party software provider, the Schlage Programmable Electronic Deadbolt (BE367) and Schlage Electronic Interconnect Lock (FE210) are non-touring capable with the iButton credential
  - Durable stainless-steel packaging
  - Unique factory programmed 64-bit registration number
  - Momentary contact initiates identification
  - Data transfer rate of up to 16.3kbps



## Multi-family electronic interconnect lock



Schlage Electronic Interconnect Lock with Manhattan lever in Satin Nickel

### Benefits

- Eliminates deadbolt replacement and re-keying costs
- Reduces key management costs
- Prevents unauthorized key duplication
- Improves building security
- Increases property value
- Potential new revenue streams

### Standard features

- Interconnect mechanism is adjustable
- Lever trim is non-handed and field reversible
- Grade 2
- UL 3-hour rating available
- Time and date controlled access
- Easy to install – fits on standard residential door preps
- Vandal resistant free-spinning deadbolt turn
- Up to 500 users
- Audit trail reports up to 1,000 events
- Battery powered – no wiring required
- Average 3-year battery life
- Low battery warning
- iButton credential required (sold separately)
- Hidden back-up mechanical key override

### Finishes



505/605  
Bright Brass



609  
Antique Brass



619  
Satin Nickel



625  
Bright Chrome



626  
Satin Chrome



716  
Aged Bronze

### Specifications

ANSI/BHMA	Grade 2 certified
UL rating	UL 3-hour rating available
Latch	UL latch comes with 1" x 2 1/4" square and round corner face plans (square corner standard, round corner included in package. 1" edge bore required)
Strikes	1 1/8" x 2 3/4" square corner deadbolt strikes and 2 1/4" x 1 5/8" square corner full lip latch strikes reinforcer. Dust box not included.
Backset	Adjustable backset, fits 2 3/8" or 2 3/4" backsets
Levers	All lever trim is non-handed and field reversible
Stile width	Minimum 4 1/2" for 2 3/8" backset, minimum 5" stile for 2 3/4"
Return to door	Saturn (SAT) and Neptune (NEP) are return to door code compliant
Cylinder	5-pin solid brass, layered 5-pin, C keyway, keyed different (KD)
Keys	5-pin, C section
Door range	1 3/8" to 1 3/4" standard. 1 3/4" to 2" optional. Must be specified.
Center to center	Fits 4" or 5 1/2" center to center door preps
Battery	9V battery included
Credential	Deadbolt is operated using iButton credential (sold separately)

### Door preparation

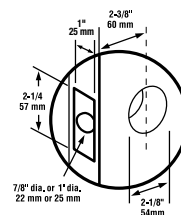



## Mechanical interconnected locks



CS210-B500



CS210-B60



Interior  
Camelot



Interior  
Plymouth

The CS210F mechanical interconnected locks provide panic-free, single motion egress and comply with the requirements of the National Fire Protection Association (NFPA) codes and local building codes.

To meet the demands of residents, the mechanical interconnect is available with several new features:

- Both the CS210F accept a variety of commercial and all residential levers, to provide never before available suiting options for our Schlage interconnected product line
- Available in split lever designs and finishes
- Select levers are code-compliant with return to door requirements and meet ADA requirements
- The interconnect mechanism is adjustable to 4 and 5 1/2 door preparations
- Available with removable core and restricted keyways
- I/C core availability
- Limited lifetime mechanical warranty

### Benefits

- Single motion egress meets life and safety code requirements
- Ideal for both new construction and renovation/aftermarket projects
- Easy to install, fits standard door preparations

### Markets

- Apartment communities
- Assisted living communities
- Student housing
- Light commercial
- Single family condominiums and town homes

### Finishes



505/605  
Bright brass



609  
Antique brass



619  
Satin nickel



625  
Bright chrome



626  
Satin chrome



716/643e  
Aged bronze

### Specifications

ANSI/BHMA	Grade 2 certified
UL rating	UL 3-hour rating is standard
Latch	UL latch comes with 1" x 2 1/4" square and round corner face plans (square corner standard, round corner included in package. 1" edge bore required.
Strikes	1 1/8" x 2 3/4" square corner deadbolt strikes and 2 1/4" x 1 5/8" square corner full lip latch strikes reinforcer. Dust box not included.
Backset	Adjustable backset, fits 2 3/8" or 2 3/4" backsets
Levers	All lever trim is non-handed and field reversible
Stile width	Minimum 4 1/2" for 2 3/8" backset, minimum 5" stile for 2 3/4"
Return to door	Saturn (SAT) and Neptune (NEP) lever styles are return to door code compliant
RS210F cylinder	5-pin solid brass, layered 5-pin, C keyway, keyed different (KD)
CS210F cylinder	6-pin solid brass, keyed 6-pin, C123 keyway, keyed different (KD), Keys are 6-pin, Everest S123 section.
Keys	5-pin, C section
Door range	1 3/8" to 1 3/4" standard. 1 3/4" to 2 optional. Must be specified
Center to center	Fits 4" or 5 1/2" center to center door preps

### Door preparation

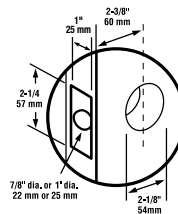

## Contents

Architectural hinges

Continuous hinges

Pivots

Manual flush bolts

Automatic flush bolts

Constant latch flush bolts

Coordinators

Dust-proof strikes

Vandal-resistant trim

Door trim

Stops

Roller latches and catches

Surface bolts

Lock guards

Rescue Hardware

For more than 120 years Ives has produced a full line of premium quality building hardware and accessories that delivers application flexibility and superior value. The expansive portfolio includes hinges, pivots, flush bolts, strikes, door trim, pulls, protection plates, lock guards and many other hardware accessories. As the leader in door accessory hardware, Ives provides premium quality products that are tough, durable and attractive. Available in a full complement of architectural finishes, Ives accessories coordinate seamlessly for a complete, secure, attractive door solution.

## Architectural hinges, continuous hinges and pivots

### Architectural hinges

Ives offers a variety of standard and heavy-duty hinges in three-knuckle plain bearing, spring hinge, concealed bearing and heavy-weight concealed-bearing configurations, as well as five-knuckle ball bearing, plain bearing, swing clear and ball bearing heavy-weight designs and electrified hinges.

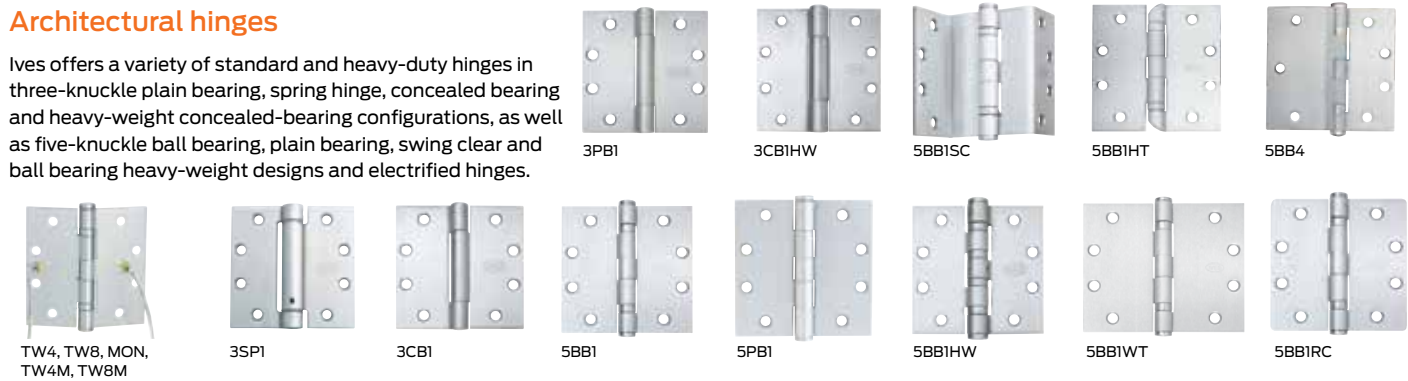

### Continuous hinges

Ives continuous hinges are designed to last the life of the building. Their unique design distributes the weight of the door uniformly along the entire length of the frame, keeping the door in constant alignment. By eliminating the gap between the door and the frame, Ives continuous hinges help avoid pinched fingers and create an effective barrier to sound and weather. These benefits result in higher efficiency and less maintenance, maximizing the value of your opening investment. Aesthetically, continuous hinges provide a clean look in new construction or aftermarket applications. Modified outlets available to accommodate most electrical frame to door requirements; through wire or EPT.

#### Geared

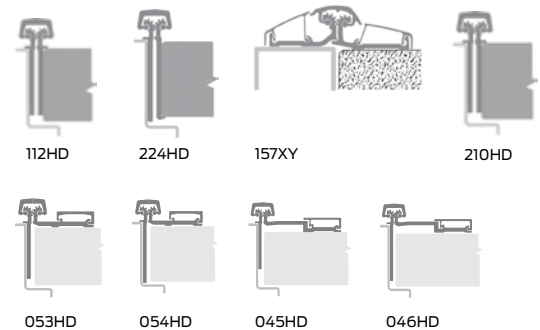

#### Pin and barrel

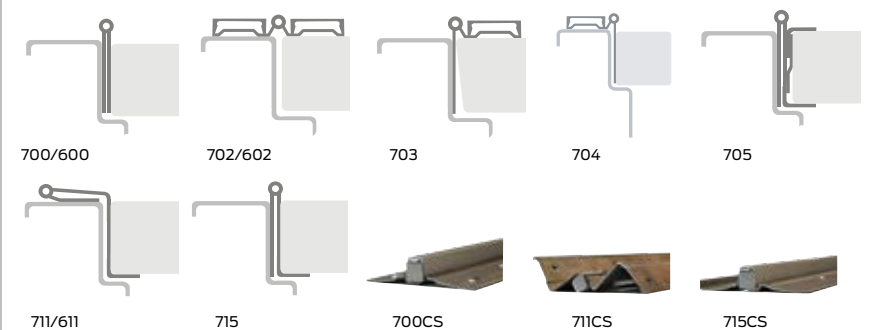

### 157XY



### Pivots

Ives pivots offer an attractive way to hang high traffic interior or exterior doors. Because the weight of the door is supported by the floor, pivots are also an excellent choice for very heavy doors.

- Available for 3/4" (19mm) offset, 1 1/2" (38mm) offset, and center-hung applications.
- Brass and stainless steel models available in a wide range of plated and powder-coated finishes.
- Fire-rated models with the "F" suffix are rated for three-hour labeled fire doors.
- Precision bearings ensure smooth operation.
- Positive locking vertical adjustment mechanism allows the installer to precisely position the door and balance the load.

Also available: 91105F pocket pivot





## Flush bolts



### Manual

- UL/cUL Listed extension flush bolts.
- FB358 is for use as top and bottom flush bolt to secure inactive leaf of a pair of swinging fire doors not exceeding 1½ hour fire rating and 10' (254mm) in height.
- FB457 and FB458 brass models are for use on all types of labeled metal fire doors not exceeding three-hour fire rating and 10' (254mm) in height.



### Automatic

- FB31P for hollow metal doors. Pair contains FB31T top bolt and FB31B bottom bolt. Non-handed. Top and bottom bolts not identical. Top bolt has no spring tension, minimizing the actuation force and providing a smooth, easy operation.
- FB32 consists of FB31T top bolt and an auxiliary fire latch which replaces the bottom bolt, eliminating floor prep and reducing required door prep. Auxiliary fire latch, mounted in the door edge, releases under extremely high temperatures to keep doors in alignment during a fire.
- FB31P and FB32 are UL/cUL Listed for pairs of metal fire doors rated up to three hours.
- FB33 updates existing flush bolt installations with auxiliary fire latch, eliminating bottom bolt and floor strike. FB33 consists of FB31T top bolt, auxiliary fire latch and filler plate to cover existing cutout when bottom bolt is removed.
- FB41P is UL/cUL Listed for pairs of wood fire doors rated up to 1½ hours.
- FB41P for wood doors. Pair contains FB41T top bolt and FB41 bottom bolt. Non-handed. Top and bottom bolts not identical. Similar to FB31T design, FB41T top bolt has no spring tension and provides a significantly reduced activation force.
- FB42 is UL/cUL Listed for pairs of wood fire doors rated at 20 minutes.
- FB42 model consists of an FB41T top bolt and an auxiliary fire latch. This combination greatly reduces door prep and eliminates field problems caused by door warpage or changes in field conditions.

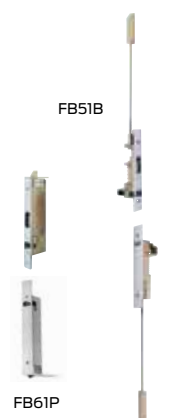

### Constant latching

- FB51P and FB61P Series incorporate a constant latching top bolt with automatic bottom bolt. FB51P models are UL/cUL Listed for use on pairs of metal fire doors rated up to three hours, while FB61P models are UL/cUL Listed for use on wood doors with ratings up to 1½ hours.
- Bottom bolts identical to FB31P/FB41P models. Top bolts are designed to remain engaged until manually retracted. Inactive door automatically latched when closed.
- FB51P for hollow metal doors. Combines FB51T constant latching top bolt with FB31B automatic bottom bolt. Non-handed. FB52 combination includes FB51T top bolt and auxiliary fire latch, reducing door prep and eliminating floor prep.
- FB52 is UL/cUL Listed for pairs of metal fire doors rated up to three hours.
- FB53 used to update existing flush bolt installations with auxiliary fire latch, eliminating bottom bolt and floor strike. FB53 consists of FB51T top bolt, auxiliary fire latch and filler plate to cover existing cutout when bottom bolt is removed.
- FB61P is UL/cUL Listed for pairs of wood fire doors rated up to 1½ hours.
- FB61P for wood doors. Combines FB61T constant latching top bolt with FB41B bottom bolt. FB62 combination includes FB61T top bolt with auxiliary fire latch. Non-handed. Significantly reduces door prep.
- FB62 is UL/cUL Listed for pairs of wood fire doors rated at 20 minutes.

## Coordinators and dust-proof strikes



COR32, COR42, COR52, COR60, COR72

### COR Series

COR Series coordinators are designed to coordinate the closing of a pair of doors. Mounted on the stop strip, the active door level holds the active door open until the inactive door closes, allowing the active door to close. Structural steel components are housed in a durable aluminum channel.

- All units feature adjustable holding power override feature which prevents damage to doors and frames, and are compatible with Ives flush bolts. Units are available with filler bars designed to cover the remaining portion of the stop strip.
- UL/cUL Listed for use on pairs of fire doors and have passed rigid testing, far exceeding industry standards.
- Allows stop-mounted hardware to be properly installed without damaging the COR Series coordinator.



COR7G-7" arm  
COR9G-9" arm

### Gravity coordinator

- Brass construction; gravity action arm provides effective coordination for door pairs with astragals on either or both doors.
- Both versions are UL Listed for use on pairs of labeled fire doors.
- The COR7G projects 7" (177.8mm); the COR9G projects 9" (228.6mm).



CBI

### Carry bar

- For installations where it is possible to open the inactive door before the active door.
- The carry bar, mounted on the inactive door, prevents damage to the doors and other hardware; nylon roller ensures quiet operation.



DP1



DP2

### Dust proof strikes

- DP1 and DP2 are designed for use with the bottom bolt of all Ives flush bolts.
- Spring-loaded plunger returns flush to floor or threshold level anytime flush bolt is retracted, eliminating need to clean standard floor strikes.

# Door trim

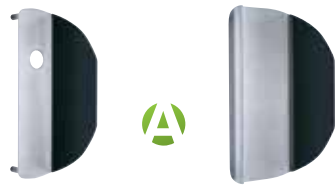

8103-8  
8103-0  
8103-2

8105-6  
8105-8  
8105-0



8112-5

8102-6  
8102-8  
8102-0



9264 Offset 36"  
9265 Offset 72"  
9266 Straight 36"  
9267 Straight 72"



8103EZ-8  
8103EZ-0  
8103EZ-2



8190-8  
8190-0  
8190-2  
8190-18

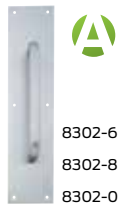

8302-6  
8302-8  
8302-0



8303-8  
8303-0

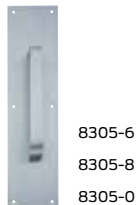

8305-6  
8305-8  
8305-0



8311-5



8200  
Pull plate



8848  
Latitude  
straight pull



8181  
Georgian  
offset pull



8312  
Plymouth  
offset pull



8169  
Tubular  
offset pull



8376  
Brookshire  
offset pull

 = Antimicrobial coating available

## Vandal-resistant trim

- Stainless steel construction.
- For use with most mortise locks.
- UR900 Series for use with most mortise locks and Von Duprin 98/99 Series devices.
- UR800 Series for use with most mortise locks and Falcon 18 Series devices.

## 8100 Door pulls

- Finished with standard type fasteners for 1<sup>3</sup>/<sub>4</sub>" thick doors; other sizes and mounting methods also available.

## 8103EZ and 8190 Door pulls

- 8103EZ - 2<sup>1</sup>/<sub>2</sub>" clearance for physically impaired.
- Pulls are available with pushbars.
- Finished with standard type fasteners for 1<sup>3</sup>/<sub>4</sub>" thick doors; other sizes and mounting methods also available.
- Conforms to ANSI A156.6.

## 8300 Door pulls

- Pulls and pull plates have uniform finish lines and special mounting methods available.
- Optional CFC or CFT; conforms to ANSI A156.6.

## 8400 Door protection plates

- Protection plates can be made with brass, bronze, stainless steel or aluminum, as well as 1/8" (3mm) thick clear acrylic plastic, black or brown high-impact polyethylene.
- All brass, bronze, stainless steel and aluminum conform to ANSI A156.6.

## Pull-push plates

- Optional CFC (cut for cylinder) or CFT (cut for thumbturn).
- All brass, bronze, stainless steel and aluminum push plates conform to ANSI A156.6.

## Decorative pulls

- Door pulls offered in straight and offset models
- Door pulls available in aluminum, stainless steel and brass substrates in up to 6 standard finishes (see model for exact offering). Special BHMA finishes available on select models
- Custom special lengths available on the Latitude Series long door pulls
- Door pulls available in center to center mounting lengths 9" to 24"

## Stops, roller latches and catches

### Stops

Ives offers a range of floor- and wall-mounted door stops and holders. A wide variety of styles and functions, available in numerous materials and finishes, solve most door control problems. All units are manufactured to the highest standards of quality and designed to discourage vandalism, while maintaining an attractive and sleek appearance. Here's a sampling of some of Ives' stops and holders:



WS406CVX, WS406CCV,  
WS407CVX, WS407CCV  
**Wall bumpers**



WS443, WS447  
**Heavy-duty wall bumper**



FS436  
**Dome stop**



WS445, WS449  
**Heavy-duty wall stop and holder**



FS18S  
**Security door stop**



FS18L  
**Security door stop**



FS444, FS448  
**Heavy-duty floor stop**



FS446, FS450  
**Heavy-duty floor stop and holder**



FS434  
**Floor stop**



FS40 Series  
**Automatic holders**



RB470  
**Roller bumper**



FS452  
**Kick down holder**

### Roller latches and catches

Ives roller latches are available in a variety of materials and finishes, providing attractive and dependable solutions for numerous applications.

#### RL30 roller latch

Brass or bronze units feature silent rubber roller (nylon or nylon-covered brass rollers optional) and are available with standard 2 1/4" (57.2mm) x 1 11/16" (42.9mm) strike or 4 7/8" (123.8mm) ASA strike (suffix A). Projection of roller is easily adjusted by way of adjusting screws on face of unit.



RL30



RL32

#### RL32 roller latch

Available in brass, bronze or stainless steel and is designed to fit a heavy-duty cylindrical lock mortise. Units feature silent rubber roller (nylon or nylon covered brass rollers optional) and are available with standard 2 3/4" (69.9mm) x 1 1/8" (28.6mm) strike or 4 7/8" (123.8mm) ASA strike (suffix A). Knurled nut on back of latch provides easy adjustment of roller projection.



CL21A

#### CL21A cabinet catch

Ideal for holding closet doors, access doors or other medium-duty hinged openings.

# Surface bolts / Lock guards

## Surface bolts

Ives surface bolts provide maximum security on virtually any style door. Featuring 1" throw, models are available in top or bottom mount versions.

- SB1630B (203.2mm) bolt with bottom strike [SB1630T (203.2mm) unit with top strike (not shown)]
- SB1630TL (203.2mm) locking bolt with top strike [SB1630BL (203.2mm) unit with bottom strike (not shown)]
- 453/454 surface bolts for maximum security



## Lock guards

LG Series lock guards are available in five styles and the most popular finishes. All models are designed to cover the latchbolt area of the door and frame, providing added protection from vandalism or normal abuse. All units feature heavy-gauge construction.

- LG1 - ideal for use with mortise or cylindrical lock
- LG10 - ideal for use with rose or escutcheon 2 3/4" (69.9mm) wide or less
- LG11 - for aluminum doors with latch type locks or doors equipped with electric strikes
- LG12 - narrow design for use on rose or escutcheon 3 1/2" (88.9mm) or less (type 86 mortise and 161 cylindrical locks)
- LG13 - compact design ideal for use on type 161 cylindrical locks, monolock and UNI lock



## Rescue hardware

Ives rescue hardware was specifically designed to address a problem often encountered by healthcare professionals — a blocked doorway caused by an incapacitated patient.

Used in conjunction with center hung pivots, rescue hardware allows a bi-directional door swing in emergency situations. When a patient becomes trapped behind an inward swinging door, the center tong depresses allowing the door to swing in the opposite direction without causing damage to the frame.



Rescue hardware is a valuable element in patient room restrooms, utility closets, and small spaces in hospitals, institutions, and convalescent homes. Rescue hardware is composed of either a rescue strike or an emergency stop assembly.

## Ives architectural finishes

Description	US number	BHMA steel	Brass/bronze	Stainless steel
Primed for painting	USP	600		
Bright brass	US3	632	605	
Satin brass	US4	633	606	
Satin bronze	US10	639	612	
Oil rubbed bronze	US10B	640	613	
Satin nickel	US15	646	619	
Bright chromium	US26	651	625	
Satin chromium	US26D	652	626	
Bright stainless steel	US32			629
Satin stainless steel	US32D			630

Ives adheres to the BHMA finish guideline designations. BHMA SYMBOL BASE MATERIAL



Some items may not be available in all finishes.



**Contents**

LCN overview

4000 Series

1000 Series

High security closers

Concealed closers

Fire/life safety solutions

Finishes

Automatic operators

Accessories



Since 1876 LCN has been the undisputed innovator and leader in the door control. LCN products include surface and concealed door closers, ADA compliant automatic door operators and electronic accessories that protect the opening and enhance the overall safety and security of a facility. These devices are found in high traffic areas such as hospitals, schools, government buildings, and commercial settings and enhance security by ensuring doors latch. LCN sets the standard for exceptional performance in door control at life's critical moments.



## Reliability. Quality. Service & support

### Welcome to superior performance

The doors that welcome customers, students, patrons and visitors are crucial aspects of the overall facility experience. High traffic zones, wherever they are in a building, rely on consistent and reliable door performance in the face of high use and abuse.

### The heart of the opening

At the heart of an opening is the door closer. It not only protects the integrity of the opening, but also the safety and security of its users. It is the mechanical pulse of the facility, and maintaining closer performance in the face of high use and abuse is a constant concern of facility managers and owners.

### LCN: the leader in door control

High traffic environments are where LCN's portfolio of heavy-duty closers is setting the standard for exceptional performance. Not surprisingly, it all begins with what goes into them: premium materials that are engineered and manufactured to obsessively tight tolerances. What's more, LCN closers utilize several patented components and are assembled in the United States.

### The no-compromise zone

In openings that are subject to high use and abuse, LCN door closers enhance security by ensuring doors latch and provide fire and life safety by adhering to stringent building codes.

### LCN stands for:

- Reliable performance
- Greatest value for ownership
- Protection for the entire opening
- Security and safety
- Better facility experience
- High quality, for peace of mind
- Unmatched service and support

## LCN on the outside means quality on the inside



### Cast iron cylinders

- Heavy-duty cast iron is the strongest and most reliable cylinder material available
- Superior burst and yield strength
- Natural graphite lubricates parts, reducing wear
- Robust wear eliminates internal leaks
- Minimum porosity



### Cast aluminum closers

- Alternative, high-quality, cost effective solutions
- The most common hole patterns in the industry
- Patent Pending design
- Easy aftermarket replacement



### Heavy-duty forged steel arms

- Arm performance significantly impacts door closer stability and control
- Forging process optimizes material strength
- Resists bending and breaks from abusive use and side loading
- Available in hold open and spring cush applications
- Smooth appearance



### Double heat treated pinions/full compliment bearings

- Double heat treated steel pinions reduce wear
- Wider pinion journal provides a larger bearing load
- Extremely hard needles and full compliment bearings provide more surface area, increasing bearing load and delivering maximum protection to the pinion shaft, eliminating wear and leaks

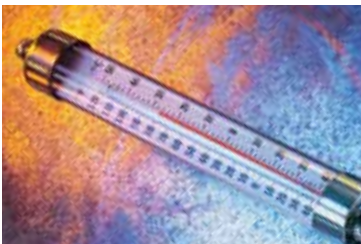

### All-weather fluid

- Fluid is the "lifeline" of any hydraulic closer
- All-weather fluid keeps closer components working smoothly
- Significantly reduces the need for seasonal adjustments





### Fast power adjust dial

- A revolutionary visual indicator for spring power adjustments
- Simply adjust to the size you want
- Results in quick and accurate spring settings
- Door closers are easily adjusted and maintained for maximum door control



### Heavy-duty surface closers

- Big 1.5-inch cylinder bore provides maximum control in high use and high abuse conditions
- Exceeds ANSI/BHMA minimum industry standard cycle requirement
- Double heat-treated steel pinion
- Meets ADA requirements
- UL Listed



### Heavy-duty concealed closers

- Designed for high traffic applications
- Available for hollow metal, aluminum or wood doors and frames
- Concealed in the frame
- Meets ADA requirements
- UL Listed



### Heavy-duty automatic operators

- Full line of operators designed specifically for any application
- Available surface mounted or concealed in various finishes
- Meets UL Listed requirements
- Meets ADA requirements



### Heavy-duty high security closers

- Designed for high traffic and high security areas
- Heavy-duty steel mounting plate minimizes tampering/vandalism
- Heavy-gauge metal security covers
- Utilizes TORX machine screws, minimizing tampering/vandalism
- Available surface mounted or concealed
- Meets ADA requirements
- UL Listed



## 4000 Series surface mounted closers

### 4040XP/4040XPT



4040XP shown

**The most durable heavy-duty door closer providing the most reliable performance and longest life in “real world” abusive conditions. Designed for high traffic applications.**

#### Features and benefits

- Strongest pinion ever at 3/4" diameter
- Widest bearing ever - 5/8"
- Stronger pinion teeth
- V-Shield™: Advanced V-shield seals for extended life
- Cast iron construction offers proven durability
- Non-sized cylinder is adjustable for interior doors to 5'0" (1524mm) and exterior doors to 4'0" (1219mm)
- FAST™ power adjust for accurate on-site spring power adjustment
- Peel 'n' Stick template for easy installation
- EDA and CUSH arms available
- Closers to mount hinge side, top jamb or parallel arm
- Allows accurate on-site spring power adjustment
- Closers meet ADA requirements
- Forged steel arm
- Double heat-treated steel pinion
- All-weather fluid eliminates seasonal adjustments
- Non-handed design for installation flexibility
- UL/cUL Listed
- Tested and certified under ANSI standard A156.4, Grade 1

#### Available options

- Custom powder-coat finish
- Plated finish on metal cover, arm and fasteners
- SRI primer for installations in corrosive conditions\*
- Metal cover available



### 4010/4020/4110/4010T/4020T/4110T Series



4110 EDA shown

**LCN's best performing heavy-duty closer designed for institutional and other rugged, high traffic applications.**

#### Features and benefits

- Over 50 years of proven performance
- Cast iron cylinder offers proven durability
- Forged steel main arm
- Double heat-treated steel pinion
- Handed for left- or right-swinging door
- FAST™ power adjust for accurate on-site spring power adjustment
- Peel 'n' Stick template for easy installation
- V-Shield™: Advanced V-shield seals for extended life
- Extra-Duty Arm (EDA) standard on 4110
- UL/cUL Listed for self-closing, fire-rated doors without hold open
- Non-sized cylinder adjustable for interior doors to 4'6" (1372mm) and exterior doors to 3'6" (1067mm), size 6 for interior doors to 5'0" and exterior doors to 4'0"
- Closers to mount hinge side, top jamb or parallel arm
- Size one cylinder meets ADA requirements on 3'0" (914mm) interior door
- Six standard powder-coat finishes available
- Tested and certified under ANSI Standard A156.4, Grade 1
- All-weather fluid eliminates seasonal adjustment

#### Available options

- Delay action for additional adjustable closing time
- Advanced variable backcheck allows earlier backcheck control on high-abuse installations (4110 Series only as well as the 4010 and 4020, with Special Templates)
- Metal cover available
- SRI primer provides additional protection to an already durable powder-coat finish
- Custom colors allow the closer to match unique door and frame finishes
- Plated finishes available

## 4000 Series surface mounted closers

### 4030/4030T Series



4030 shown

The 4030 is a cast iron, universal closer designed specifically for interior doors in moderate traffic applications.

#### Features and benefits

- Cast iron cylinder offers proven durability
- Forged steel main arm, multiple arm options
- Heat-treated steel pinion
- Standard metal cover
- UL/cUL Listed for self-closing, fire-rated doors without hold open
- Non-sized (1-4) 4031 cylinder for exterior doors to 36" (914mm) and interior doors to 48" (1219mm)
- Closer mounts hinge side, top jamb and parallel arm, on either right- or left-swinging doors
- Size one cylinder meets ADA requirements on a 3'0" (914mm) interior door
- Six standard powder-coat finishes available
- Tested and certified under ANSI standard A156.4, Grade 1
- All-weather fluid minimizes seasonal adjustments

#### Available options

- SRI primer provides additional protection to an already durable powder-coat finish
- Custom colors allow the closer to match unique door and frame finishes
- Plated finishes are also available
- Hold open available

### 4000T Series



4000T shown

The 4000T Series is LCN's heavy-duty track closer designed for interior pocket doors in institutional and other rugged, high traffic applications.

#### Features and benefits

- Cast iron cylinder offers proven durability
- Forged steel arm
- Double heat-treated steel pinion
- UL/cUL Listed for self-closing, fire-rated doors without hold open
- Wall pocket installation for fire/life safety in an aesthetically pleasing application – use SEM7850 wall magnet
- Uses modified 4040XP
- Non-handed
- Sized cylinders for interior doors to 4'0" (1219mm)
- Six standard powder-coat finishes available
- Tested and certified under ANSI standard A156.4, Grade 1
- All-weather fluid eliminates seasonal adjustments

#### Available options

- Metal cover available
- SRI primer provides additional protection to an already durable powder-coat finish
- Custom colors allow the closer to match unique door and frame finishes
- Plated finishes are also available



= Complies with ADA accessibility guidelines



= Helps meet LEED certification



= Advanced V-shield sealing technology



## 4000 Series surface mounted closers

### 4050 Series



4050 shown

**Designed for high-frequency and highly-abusive traffic areas, the 4050 series is ideal for commercial building applications and competitive specification situations that demand a combination of quality, reliability and value. The 4050 series offers premium features such as a patent pending design, powder coating, full complement bearing, a standard full plastic cover and optional full metal cover, 6 standard colors and unlimited custom colors.**

#### Features and Benefits

- Cast Aluminum Body
- Patent Pending Design
- Peel-n-Stick Templates
- Universal Screw Pack
- Full Complement Bearing
- Liquid X All Weather Fluid
- Adjustable Spring Size 1-6
- Non-Handed
- 25 Year Warranty

#### Available Options

- Full metal cover optional
- Optional SRI
- Multiple arm options
- Custom colors optional

## 1000 Series surface mount

### 1250 Series



1250 shown

Designed for low-frequency and low-abusive traffic areas, the 1250 series is ideal for aluminum storefronts, interior offices and many other applications. This combines dependable operation, low maintenance and a stylish look, with or without the optional slim line cover.

#### Features and Benefits

- Cast Aluminum Body
- Patent Pending Design
- Peel-n-Stick Templates
- Universal Screw Pack
- Full Complement Bearing
- All Weather Fluid
- Adjustable Spring Size 1-5
- Non-Handed
- 15 Year Warranty

#### Available Options

- Slim line plastic cover optional
- Optional SRI
- Multiple arm options
- Custom colors optional

### 1260 Series

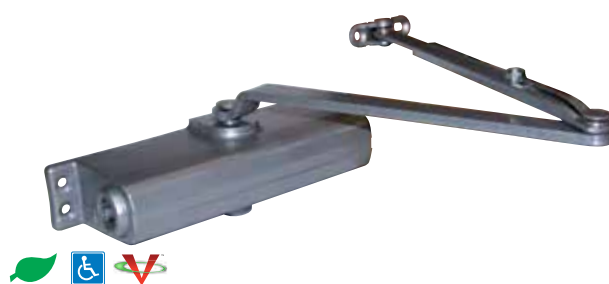

1260 shown

The 1260 Series closer from LCN is the perfect mix of performance and durability. Its cast iron construction delivers unparalleled strength and longevity, and its versatile design means the 1260 works almost everywhere.

#### Features and benefits

- Fully adjustable 1-5 spring
- Full line of arm options
- Peel-n-stick template for easy installation
- Designed for the most common commercial footprint ( $\frac{3}{4}$ " x  $9\frac{1}{16}$ " )
- Advanced V-shield seals for extended life
- Standard powder-coat finish
- Meets ADA requirements
- Tested and certified under ANSI A156.4, Grade 1

#### Available options

- Slim-line cover option
- Optional SRI primer for corrosive environments
- Custom color powder-coat finishes to match unique door and frame finishes
- Choice of arm options: regular, parallel, long, hold open, EDA, HEDA, Cush, HCush



= Complies with ADA accessibility guidelines



= Helps meet LEED certification



= Advanced V-shield sealing technology

## 1000 Series surface mount

### 1450 Series



1450 shown

Designed to deliver consistent, dependable, long-term performance, the 1450 Series is ideal for frequently-used, low-abusive areas. The patent-pending LCN design features the industry's most common hole pattern, and comes standard with a standard slim line cover, offering both a full plastic cover or full metal cover as well.

#### Features and Benefits

- Cast Aluminum Body
- Patent Pending Design
- Peel-n-Stick Templates
- Universal Screw Pack
- Full Complement Bearing
- All Weather Fluid
- Adjustable Spring Size 1-5
- Non-Handed
- 25 Year Warranty

#### Available Options

- Optional full plastic cover and optional handed metal cover
- Optional SRI
- Multiple arm options
- Custom colors optional

### 1460/1460T Series



1460 shown

**Designed for maximum versatility, the 1460 is available with multiple cover options and can be used for both commercial and institutional applications. This fully universal closer offers a wide variety of options and is fast and accurate to install.**

#### Features and benefits

- Cast iron cylinder provides proven durability
- Slim line cover is standard
- Non-sized (1-6) cylinder is adjustable for interior doors to 5'0" (1524 mm) and exterior doors to 4'0" (1219 mm)
- Closers to mount hinge side, top jamb and parallel arm
- Non-handed
- Size one cylinder meets ADA requirements on a 3'0" (914mm) interior door
- Peel-and-stick template for easy installation
- UL/cUL Listed for self-closing, fire-rated doors without hold open
- All-weather fluid eliminates seasonal adjustments

#### Available options

- Optional delayed action provides additional adjustable closing time
- Multiple cover options include full cover (FC) and designer series (DS)
- Full cover provides complete cylinder enclosure
- Designer series non-handed metal cover provides contoured look
- SRI primer provides additional protection to an already durable powder-coat finish
- Custom colors allow the closer to match unique door and frame finishes
- Plated finishes are also available (must use designer series (DS) cover)



= Complies with ADA accessibility guidelines



= Helps meet LEED certification



= Advanced V-shield sealing technology

## High security closers

### 2210/2210DPS Series closer

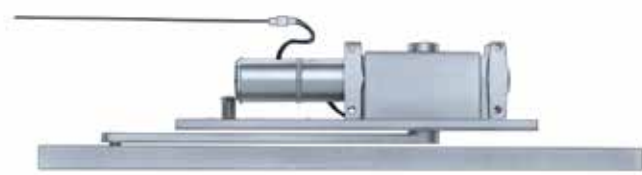

2210DPS shown

The concealed 2210 Series heavy-duty, high-security track closer features complete concealment with special components to minimize tampering and vandalism. Forged steel single-lever arm and heavy steel mounting plate are designed for correctional, vandal-prone, institutional and other high traffic applications. A choice of finishes and cylinder functions meet correctional and vandal-resistant requirements.

#### Features and benefits

- Cast iron cylinder offers proven durability
- Forged steel main arm
- Double heat-treated steel pinion
- UL/cUL Listed for self-closing, fire-rated doors without hold-open
- Sized cylinders for interior doors to 4'6" (1372mm) and exterior doors to 3'6" (1067mm). Cylinders available in adjustable size 3, 4, or 5
- Closer mounts in head frame
- Handed for either right- or left- swinging door
- Six standard powder-coat finishes available
- Tested and certified under ANSI A156.4, Grade 1
- All-weather fluid eliminates seasonal adjustments

#### Available options

- Optional door position switch (DPS)
- SRI primer provides additional protection to an already durable powder-coat finish (2210 only)
- Custom colors allow the closer to match unique door and frame finishes
- Plated finishes are also available

### 4210/4210T/4510/4510T Series closers



4210 shown

The 4210/4510 Series is a heavy-duty, high-security closer with special components to minimize tampering and vandalism. Forged steel double-lever arms and heavy-gauge metal security covers are designed for correctional, vandal-prone, institutional and other high traffic applications. A choice of finishes and cylinder functions meets correctional and vandal-resistant requirements.

#### Features and benefits

- Cast iron cylinder offers proven durability
- Forged steel main arm
- Double heat-treated steel pinion
- UL/cUL Listed for self-closing, fire-rated doors without hold open
- Sized 6 cylinder for interior doors to 5'0" (1524mm) and exterior doors to 4'0" (1219mm)
- Non-sized cylinder adjustable for interior doors to 4'6" (1372mm) and exterior doors to 3'6" (1067mm)
- Closers to mount hinge-side, stop-face or parallel mount-side
- Handed for either right- or left- swinging door
- Size one cylinder meets ADA requirements on a 3'0" (914mm) interior door
- Six standard powder-coat finishes available
- Tested and certified under ANSI standard A156.4, Grade 1
- All-weather fluid eliminates seasonal adjustments

#### Available options

- SRI primer provides additional protection to an already durable powder-coat finish
- Custom colors allow the closer to match unique door and frame finishes
- Plated finishes are also available
- AVB - advanced backcheck provides hydraulic resistance earlier in the opening cycle



= Complies with ADA accessibility guidelines



= Helps meet LEED certification

## Concealed closers

### 3030/3130 Series



3130 shown

The concealed 330/3030/3130 Series is designed to mount in a 1<sup>3</sup>/<sub>4</sub>" interior door. The double-lever arm version provides superior door control, and the choice of finishes and arm functions meets virtually all architectural requirements.

#### Features and benefits

- Sized cylinders (3030) for interior doors to 4'0" (1219mm)
- Sized cylinders (3130) for interior doors to 3'2" (965mm)
- Handed for right- or left- swinging doors
- Size one cylinder meets ADA requirements on a 3'0" (914mm) interior door
- Consult factory for installations with pivots
- Six standard powder-coat finishes available
- Tested and certified under ANSI standard A156.4, Grade 1
- All-weather fluid eliminates seasonal adjustments

#### Available options

- SRI primer provides additional protection to an already durable powder-coat finish
- Custom colors allow the closer to match unique door and frame finishes
- Plated finishes are also available

### 2010/5010 Series



2010 shown

The concealed 2010/5010 Series offers a heavy-duty closer designed for institutional, high traffic or other applications exposed to weather or abuse. The double-lever arm version (5010 Series) provides superior door control, and a choice of finishes, cylinder functions and arm functions that meets virtually all architectural requirements.

#### Features and benefits

- Sized cylinders for interior doors to 5'0" (1524mm) and exterior doors to 4'0" (1219mm)
- Handed for right- or left- swinging doors
- For hollow metal or wood door and frame
- Aluminum frame requires minimum 4" (102mm) x 4" (102mm) tube
- Size one cylinder meets ADA requirements on a 3'0" (914mm) interior door
- Six standard powder-coat finishes available
- Tested and certified under ANSI standard A156.4, Grade 1
- All-weather fluid eliminates seasonal adjustments

#### Available options

- SRI primer provides additional protection to an already durable powder-coat finish
- Custom colors allow the closer to match unique door and frame finishes
- Plated finishes are also available

### 2030/5030/6030 Series



6030 shown

The concealed 2030/5030/6030 Series PACER® is a heavy-duty closer designed to fit in a narrow, minimum 1<sup>3</sup>/<sub>4</sub>" aluminum transom. The double-lever version (5030 Series) provides superior door control, and the choice of finishes and arm functions meets virtually all architectural requirements.

#### Features and benefits

- Sized cylinders for interior doors to 5'0" (1524 mm) and exterior doors to 4'0" (1219 mm)
- Handed for right or left swinging doors (2030/5030)
- Aluminum frame requires minimum 1<sup>3</sup>/<sub>4</sub>" (44mm) x 4<sup>1</sup>/<sub>2</sub>" (114mm) tube (5030)
- Aluminum frame requires minimum 1<sup>3</sup>/<sub>4</sub>" (44mm) x 4" (102mm) tube (2030/6030)
- Size one cylinder meets ADA requirements on a 3'0" (914mm) interior door
- Double acting closer available (6030)
- Six standard powder-coat finishes available
- All-weather fluid eliminates seasonal adjustments

#### Available options

- SRI primer provides additional protection to an already durable powder-coat finish
- Custom colors allow the closer to match unique door and frame finishes
- Plated finishes are also available



## Fire/life safety solutions

### SEM 7800 magnets



SEM7830 shown

The Sentronic® SEM 7800 are a series of tri-voltage, electrically controlled door-holding magnets. Magnets are fail-safe and hold until the current is interrupted. A manual door closer is used to control and close the door.

#### Configuration

- SEM7820 - floor mount magnet
- SEM7830 - surface wall-mount magnet
- SEM7840 - low profile, recessed wall-mount magnet
- SEM7850 - standard profile, recessed wall-mount magnet

#### Features and benefits

- Tri-voltage
- 35 lbs holding force
- UL Listed for smoke barrier or labeled fire doors
- Die-cast (7800 Series) housing and armature
- Stick-on template for easy installation
- Installation placement chart for mounting location accuracy
- Shipped with a screw pack for attachment of the door mount
- Suitable for use in pocket door installations

#### Available options

- All SEM magnets are available in 12VDC, 24VAC/DV and 120VAC

### SEM 7810 magnet armature extension kit



SEM1960 shown

This 75-piece kit provides multiple-sized extensions and ball pivot/connector links to meet fire/life safety needs. The links can also be put together for multiple armature extension length options.

#### Kit includes:

- 10 1/2" extensions
- 10 3/4" extensions
- 10 1" extensions
- 5 2" extensions
- 20 ball pivot
- 20 connector links
- All armature extension kit components can be ordered separately



= Conforms to life safety code NFPA 101



= Helps meet LEED certification

### 3130SE/4040SE Series holder/closers



4040SE shown

The 4040SE Sentronic is a heavy-duty, non-handed, non-sized closer/holder designed to provide single-point hold-open for fire and smoke barrier doors. The door is held open until electrical current interruption releases the holding mechanism and the door closes. The single lever (track) arm closer is specifically designed for interior doors. Choice of finishes, track functions and installation accessories meet virtually all life safety requirements.

#### Features and benefits

- UL Listed for smoke barrier or labeled fire doors and cUL Listed for self-closing doors without hold-open
- Conforms to life safety code NFPA 101
- Cast iron cylinder offers proven durability
- 4040SE non-sized cylinders for interior doors to 4'0" (1219mm)
- Hold-open force is adjustable
- Momentary on/off switchboard assembly for testing door release also provides over-voltage protection and is field replaceable
- Functions as a full rack-and-pinion closer when hold-open is not engaged or current is interrupted
- Closers to mount on either push or pull side of the door (4040SE)
- Closer can be concealed in door (3130SE)
- Non-handed (4040SE only)
- Concealed or surface wiring
- Interfaces with alarm systems (consult factory for full details)
- Six standard powder-coated finishes available on cover and arm
- Tested and certified under ANSI standard A156.15, Grade 1
- All-weather fluid eliminates seasonal adjustments

#### Available options

- Metal cover available (4040SE only)
- Double egress arm available (4040SE only), consult factory
- Custom colors allow the closer to closely match unique door and frame finishes
- Plated finishes are also available

### 2310ME/4310ME/4410ME Series holder/closers



4310ME shown

The 2310ME/4310ME/4410ME Sentronic is a heavy-duty, electrically controlled closer/holder designed to provide adjustable hold-open for fire and smoke barrier doors. Door is held open until current interruption releases mechanism and the door closes. Single lever (track) arm closer is specifically designed for interior doors. Choice of finishes, cylinder functions and installation accessories meets virtually all life safety requirements.

#### Features and benefits

- UL Listed for smoke barrier or labeled fire doors
- Conforms to life safety code, NFPA 101
- Sized cylinders for interior doors to 4'0" (1219mm)
- Functions as full rack-and-pinion door closer when hold-open is not engaged or current is interrupted with swing-free arm engaged
- Handed for right- or left-swinging door
- ME Series available in pull side mount, push side mount or concealed in frame
- Concealed or exposed electrical connections
- Built-in "on/off" switch controls hold-open function
- Swing-free arm allows door to be moved without door closer resistance (4310ME only)
- Interfaces with fire alarm systems (consult factory)
- Six standard powder-coated finishes available
- Tested and certified under ANSI standard A156.4, Grade 1
- All-weather fluid eliminates seasonal adjustments

#### Available options

- Optional hold-open bypass feature available (85°, 140°)
- Custom colors allow the closer to match unique door and frame finishes
- Plated finishes are also available

# Finishes

## Powder-coated finishes

LCN closers and automatic operators can be specified in six standard finishes or over 180 custom powder-coated finishes. Powder-coating provides superior protection against the effects of weathering and provides a durable, chip-resistant finish.

### Standard powder-coated finishes

Colors shown are approximate.



AL (BHMA 689)  
Aluminum



DKBRZ (BHMA 695)  
Dark bronze



STAT (BHMA 690)  
Statuary bronze



LTBRZ (BHMA 691)  
Light bronze



BLACK (BHMA 693)  
Black



BRASS (BHMA 696)  
Brass

### Optional SRI

When powder-coated closers are installed in high humidity or potentially corrosive installations like swimming pools, water treatment facilities or near large bodies of water, specify LCN SRI pre-treatment. This optional process extends the corrosion protection offered by powder-coat finishes.

### Custom powder coat finish

LCN offers custom powder coating to provide a custom appearance and all the corrosion resistance of standard powder coat finishes at a nominal additional cost. LCN uses the RAL numbering system for the 150+ custom colors available.



## Automatic operators

### 4630/4640 Series

Autoequalizer™ - electric



4630 shown

The 4630/4640 Auto-equalizer is LCN's smart and reliable, electrically powered, low-energy automatic operator. It provides easy access for people who may need additional assistance. Designed primarily for manual opening applications that occasionally require automatic opening.

Fully compliant with UL and cUL 325 and 228, and meets ANSI standards A117.1, A156.19 and the Americans with Disabilities Act.

#### Features and benefits

- Non-sized cylinders for interior doors to 4' (4630), 4' 6" (4640) and exterior doors to 3' (4635), 4' (4640)
- Non-handed
- Digital control suite with on-board diagnostics ensures trouble-free installation
- Integrates LCN's heavy-duty 4040XP cylinder
- Convenient on-board power supply for actuators and electric strikes
- Backup factory default memory allows unit to reset to original settings in just seconds
- Quick installation of motion sensors and safety sensors
- No destruct feature ensures long life even in abusive applications
- Guard rails and safety mats are not required
- Meets ADA requirements (power mode only)
- Easily accessible switches provide on/off and continuous hold-open functions.
- Control module provides all timing and sequential door functions, electric strike control, and adjustments for opening speed and force
- Six standard powder-coated finishes available

#### Available options

- Concealed on/off switch
- Custom colors allow the closer to match unique door and frame finishes
- Plated finishes are also available

### 2610/4810/4820/4840 Series

Autoequalizer - pneumatic



4810 shown

The 2610/4810/4820/4840 Auto-equalizer is LCN's pneumatically powered multi-door solution. This low-energy automatic operator provides easy access for people who may need additional assistance. Designed primarily for manual opening applications that occasionally require automatic opening. Ideal for applications such as churches and libraries, where noise level is a concern.

Fully compliant with UL 228 and meets ANSI standards A117.1, A156.19, and the Americans with Disabilities Act.

#### Features and benefits

- Non-sized cylinders for interior doors to 4' (2610/4810), 4' 6" (4640) and exterior doors to 3' (4635), 4' (4640)
- Non-handed (4810, 4820, 4840)
- Handed for right- or left-swinging door (2610)
- Ideal for multi-door applications since cost-per-door leaf decreases significantly as the number of door leaves increases
- Integrates LCN's heavy-duty 4040XP cylinder
- Provides quiet, efficient and reliable operation
- Available "blow open" control box that is controlled by smoke evacuation system
- Requires LCN control boxes with internal compressor (not for blow open applications) or control box using auxiliary air supply (see Automatic operator accessories page)
- Guard rails and safety mats are not required
- Meets ADA requirements (power mode only)
- Six standard powder-coated finishes available

#### Available options

- SRI primer provides additional protection to an already durable powder-coat finish
- Custom colors allow the closer to match unique door and frame finishes
- Plated finishes are also available



= Complies with ADA accessibility guidelines



= Helps meet LEED certification

## Automatic operators

### 9500/2800 Series

#### Senior swing



9540 shown

The Swing Series is LCN's toughest line of automatic operators, designed specifically to handle applications where the primary use of the door will be automated. They are ideal for high-use, high-abuse applications and utilize an enclosed, electromechanical motor gearbox.

#### Features and benefits

- Electromechanical unit utilizes a digital control box for easy installation, programming and troubleshooting
- Power boost feature provides extra energy assist during latch to help overcome external pressure conditions
- Push 'n' go option will activate door once manually opened to minimal degree
- On-board power supply provides 24V AC or 24V DC output with rectifier to power additional hardware
- Auto reverse on opening and closing cycle provides additional safety when it encounters a person or obstruction
- Plug 'n' play connections allow for easy and more accurate installation
- Top jamb mounted and bottom load accessible to allow for maintenance or troubleshooting without removing cover
- Handed for right- or left- swing doors
- Meets all ANSI A156.19 requirements
- Meets ADA requirements
- UL Listed
- Available in surface (9500) or concealed (2800) mounting options

#### Available options

- 36" header length standard, but can request 30" to 49" max for single door
- Single control box can be used to automate a simultaneous pair of doors
- Full length header for double doors available up to 98"
- Aluminum or dark bronze finish

### 9100 Series

#### Benchmark



9140 shown

The Benchmark by LCN is an electromechanical low energy operator designed as an economical solution when door automation is desired. The Benchmark is designed for applications when the primary use of the door will be automated, and primarily for low to moderate traffic and abuse. It's also cost effective and the ideal product for retrofit applications.

#### Features and benefits

- Electromechanical unit utilizes a fully labeled control box for easy installation, programming and troubleshooting
- LED lights illuminate to show power to both unit and motor gear box to help assist with installation and troubleshooting
- Power boost feature provides extra energy assist during latch to help overcome external pressure conditions
- Push 'n' go option will activate door once manually opened to minimal degree
- On-board power supply provides 24V DC output with rectifier to power additional hardware
- Auto reverse on opening and closing cycle provides additional safety when it encounters a person or obstruction
- Top jamb mounted, non-handed unit allows for left- or right-swinging doors
- On/off concealable switch comes standard
- Meets all ANSI A156.19 requirements
- Meets ADA requirements
- Meets UL requirements

#### Available options

- Aluminum or dark bronze finish



= Complies with ADA accessibility guidelines



= Helps meet LEED certification

## Automatic operator accessories

### 8300 Series actuators and accessories



8310-856 shown

8310-854 shown

LCN offers a full line of actuators and accessories to meet many of your accessibility needs. All accessories are universal and can be used with any LCN automatic operator.

#### Actuators

- Stainless steel aluminum push plates available with ADA logo or ADA text and logo
- Available in 4<sup>3</sup>/<sub>4</sub>" square, 4<sup>1</sup>/<sub>8</sub>" or 6" round, and full length (36" x 6")
- Jamb or double jamb vestibule switches
- Surface or flush mounting boxes with optional weather rings available for all style plates (except -818)
- Can be hard-wired or used with wireless transmitter
- Touchless surface-mount actuator for use with clean or sanitary applications

#### Wireless "ready mount" actuators

- Available in 4<sup>3</sup>/<sub>4</sub>" square, 6" round, or full length (36" x 6")
- Comes complete with enclosed wireless transmitter, surface mount box, easy mounting bracket and push plate
- Waterproof for interior or exterior mounting (except -818)
- Slim line 1<sup>1</sup>/<sub>2</sub>" profile reduces interference from pedestrians or obstructions

#### Wireless transmitters and receiver

- Transmitters available for push plate connection, or as 1- to 4-button handheld key fob
- Receiver's small profile can fit inside any LCN automatic operator head
- Receiver can program up to 100 individual transmitters



8310-855 shown

8310-836T shown

#### Sensors

- Header mount activation sensor (if used for primary activation, must comply with ANSI 156.10)
- Header mount safety sensor
- Door mount safety sensor

#### Bollard post

- 42" x 4" x 6" aluminum finish post
- Used with 4<sup>3</sup>/<sub>4</sub>" square, 4<sup>3</sup>/<sub>4</sub>" ready-mount or double-jamb actuator or full length
- Comes with shelf to hold wireless transmitter to increase frequency range

# Automatic operator accessories

## Pneumatic system control boxes



7982ES shown

### 7901 Series

For use in a single door application or independent control of a single door in a multiple door system. Two door leaves can be operated if they are activated simultaneously. The single pneumatic circuit accepts “normally open” (N.O.) inputs from hard-wired or remote wireless actuator/receiver combinations. The 7901 control box requires a separate compressor (recommended LCN 920 Series)

- **7901ES:** Includes strike relay

### 7902 Series

For independent operation of two door or four door leaves, if pairs are actuated simultaneously. Two independent pneumatic circuits accept N.O. inputs from hard-wired or wireless actuator/receiver combinations. Control box requires a separate compressor (recommended LCN 920 Series).

- **7902ES:** Includes strike relay
- **7902SES:** Includes strike relay and sequential card

### 7981 Series

Self-contained control box/compressor combination for single door leaf applications. The single pneumatic circuit accepts N.O. inputs from hard-wired or wireless actuator/receiver combinations. Does not require separate compressor.

- **7981ES:** Includes strike relay

### 7982 Series

Self-contained control box/compressor combination for independent or simultaneous operation of two door leaves. Two independent pneumatic circuits accept N.O. inputs from hard-wired or wireless actuator/receiver combinations. Does not require separate compressor.

- **7982ES:** Includes strike relay
- **7982SES:** Includes strike relay and sequential card

### 7949 Series

Auxiliary “blow open” box works with or without 7901 or 7902 control box and one or two pneumatic automatic operators. Controlled by the smoke evacuation system, the 7949 opens a door or doors to allow clean air into the building during emergency conditions. Normal power operator functions are not available when “blow open” function has been activated.

- **7949ES:** Includes electric strike relay

### Additional features and benefits

- Two year warranty
- Auxiliary compressors supplied by others
- Electric strike must be powered with separate power supply

**GLYNN-JOHNSON®**

Door control hardware



### Contents

Overhead door holders/stops

Push/pull latches

Known throughout the industry as the “overhead door holder specialist,” Glynn-Johnson has made its name with state-of-the-art manufacturing and technology. The portfolio also includes a full line of push/pull latches that are ideal for healthcare applications. Delivering both superior quality and exceptional performance, Glynn-Johnson products are offered in a wide variety of popular finishes and configurations providing the flexibility needed to meet the most demanding door control applications.



## Concealed overhead door holders/stops

Single- or double-acting doors, Interior/exterior applications, reversible, non-handed



### 410 Series

Concealed holders and stops offer the widest variety of functions and finishes to fit light- to medium-duty commercial applications.

#### Features

- Broad range of finishes and sizes. Please consult your Allegion representative for details.
- UL Classified as miscellaneous fire door accessory. Applies to concealed overhead stops used in hollow metal fire doors.

#### Functions

- **H-410H** hold-open models feature a rugged, automatic hold-open. The hold-open mechanism has been tested in excess of the 250,000 cycles required for a Grade 1 holder, providing an automatic, adjustable hold-open when the door reaches the templated degree of hold-open.
- **S-410S** stop-only models offer a smooth and rugged shock-absorbing mechanism designed to protect door and frame.
- **F-410F** friction hold-open models provide a convenient multi-point, hold-open mechanism, permitting the door to be held open at various degrees. The tension on the friction mechanism is adjustable.

#### Options

- **Suffix SE** - stop-only model is furnished without shock absorber (for use with single point hold-open electronic closers).



### 100 Series

Concealed holders and stops provide the most attractive and reliable heavy-duty door control. Ideal for use on entrance and vestibule doors, high-traffic doors, large doors or doors subject to abuse.

#### Features

- Low-profile channel, constructed of heavy-gauge brass material, mortised in door and concealed from view.
- Jamb bracket mortised in door frame, also concealed from view when door is in the closed position.
- Set in the inactive position, acts as a stop and shock absorber.
- Designed for heavy-duty applications; far exceeds BHMA cycle test and force test requirements for Grade 1 holders and stops.
- UL Classified as miscellaneous fire door accessory (applies to concealed overhead stops used in hollow metal fire doors).
- Broad range of finishes and sizes; please consult your Allegion representative for details.

#### Functions

- **H-100H** hold-open model features the most reliable hold-open mechanism which is both selective and adjustable, featuring a control knob which turns the hold-open function on or off. The hold-open tension is a simple adjustment with an allen wrench.
- **S-100S** stop-only models provide rugged shock-absorbing ability, but are furnished without the hold-open mechanism.
- **F-100F** friction hold-open models provide a heavy-duty, multi-point, hold-open mechanism and adjustable tension, ideal for situations where various degrees of hold-open are required.

#### Options

- **Suffix HP** - available on H Series hold-open models. Provides pre-set automatic hold-open built into the channel.
- **Suffix ADJ** - adjustable jamb bracket (available on sizes 3, 4, 5 and 6) allows for manual setting of the degree of opening from 85 to 110 degrees.

# GLYNN-JOHNSON®

## Surface overhead door holders/stops

Single acting doors, interior/exterior applications, reversible, non-handed



### 450 Series

Surface-mounted holders and stops offer the widest variety of functions, base materials and finishes to fit light- to medium-duty commercial applications.

- Three basic models are available, each offered in five sizes:
  - **H-450H** - Hold-open model
  - **F-450F** - Friction hold-open model
  - **S-450S** - Stop-only model
- UL Classified as miscellaneous fire door accessory. Applies to surface overhead stops used in hollow metal and wood fire doors.

#### Options

- Suffix J** - 450J angle jamb bracket affixes to standard jamb bracket for hinge side or flush transom mounting.
- Suffix SE** - stop-only function for use with single-point, hold-open electronic closers.



### 81 Series

Surface overhead holders and stops are designed to provide the most effective shock-absorbing capability. They provide protection for doors, frames and related hardware.

- The 81 Series holders provide a reliable hold-open function and are compatible with many door closers.
- Available as H Series hold-open or S Series stop-only models, each available in five sizes to accommodate virtually all openings.
- UL/cUL Classified as miscellaneous fire door accessory. Applies to surface overhead stops used in hollow metal and wood fire doors.

#### Options

- Suffix J-81J** angle jamb bracket affixes to standard jamb brackets for hinge side or flush transom mounting.



### 90 Series

Surface-mounted holders and stops provide the most versatile and attractive variety of functions, materials and finishes to fit heavy-duty applications.

- Three basic models are available, each offered in five sizes to accommodate virtually all openings:
  - **H-90H** - Hold-open model
  - **F-90F** - Friction hold-open model
  - **S-90S** - Stop-only model
- UL Classified as miscellaneous fire door accessory. Applies to surface overhead stops used in hollow metal and wood fire doors.

#### Options

- Suffix J** - 90J angle jamb bracket affixes to standard jamb brackets for hinge side or flush transom mounting.
- Suffix SE** - stop-only function for use with single point, hold-open electronic closers.



### 70/79 Series

Surface-mounted holders and stops combine rugged construction and simple installation for extremely reliable heavy-duty door control.

- The 70 Series is designed around a 1/2" (12.7mm) diameter 300 Series stainless steel bar, while the 79 Series utilizes a 3/4" (19.1mm) diameter bar, also constructed of 300 Series stainless steel.
- Components including jamb brackets, door brackets and hold-open/ shock absorber mechanisms are constructed primarily of brass and stainless steel. Several components are fabricated of corrosion-resistant steel material.
- Models are available in hold-open and stop-only functions, each offered in five sizes:
  - **H-70H** - Hold-open: heavy-duty
  - **S-70S** - Stop-only: heavy-duty
  - **H-79H** - Hold-open: extra heavy-duty
  - **S-79S** - Stop-only: extra heavy-duty
- UL/cUL Classified by as miscellaneous fire door accessory. Applies to surface overhead stops used in hollow metal and wood fire doors.

## Push/pull latches

### HL6 push/pull latch

- For installations where both versatility and durability are critical. Ideal for use on commercial and institutional doors, including fire doors.
- Functional and modern in design, it can be mounted in any of six different positions and available in 2<sup>3</sup>/<sub>4</sub>" (69.6mm), 3<sup>3</sup>/<sub>4</sub>" (95.3mm), 5" (127.0mm) or 7" (177.8mm) backset.
- Short-throw angle allows an easy push or pull action to open the door even when hands are not free.
- UL/cUL Listed for use on all single labeled doors of metal or wood construction. No fusible link to fail.
- Meets the requirements of the Americans with Disabilities Act (ADA).



#### Options

- Suffix B** - brass base-material, standard size is zinc base material for US26 and US26D finishes
- Suffix E** - engraved push or pull
- Suffix EN** - entrance only
- Suffix EO** - exit only
- Suffix L** - lead lining
- Suffix RL** - roller latch conversion

### PL7/PL8 privacy function push/pull latch

- Patented design ideal for restrooms or patient bathrooms.
- Combines all of the features and functions of the popular HL6, with the added convenience of privacy, actuated by an attractive thumbturn. Release on opposite side provides access in case of emergency.
- Available in two models: PL7 for push-side thumbturn operation and PL8 for pull-side thumbturn operation.
- Meets the requirements of the Americans with Disabilities Act (ADA).



#### Options

- Suffix B** - brass base-material, standard is zinc base material for US26 and US26d finishes
- Suffix E** - engraved push or pull
- Suffix L** - lead lining
- Suffix RL** - roller latch conversion

### HL6 9000 push/pull latch with mortise lock

- Combines all the functions and features of the Schlage L Series heavy-duty mortise lock with popular HL6 push/pull paddle operation and versatile mounting positions.
- Units are furnished complete with Schlage lockset (less cylinders) and all necessary fasteners. All units are furnished in 2<sup>3</sup>/<sub>4</sub>" (69.6mm) backset.
- Kits are available to retrofit existing installations and they include all necessary components. 9000RK is specified for the lock function. If Schlage mortise locks are already installed, the set can be easily converted to push/pull operation with minor modifications to door.



#### Options

- Suffix B** - brass base-material, standard is zinc base material for US26 and US26D finishes
- Suffix E** - engraved push or pull
- Suffix EN** - entrance only
- Suffix EO** - exit only
- Suffix L** - lead lining

## Protect doors from wear with kick plates and armor plates

EXPERT TIPS

Especially in a healthcare setting, doors take a lot of wear and tear from people opening them with the push of a foot. Lengthen the life of your doors and prevent unsightly scratches and scuffs by adding a kick plate at the base of the door. Armor plates can also be added as a trim piece behind the push/pull latch to prevent excessive wear.



 = Antimicrobial coating available

# VON DUPRIN®

Exit devices and electronic access control systems

## Contents

### Popular options

98/99 Series pushpad exit devices

33A/35A Series pushpad exit devices

94/95 Series recessed exit devices

22 Series pushpad exit devices

GUARD-X

55/88 Series crossbar exit devices

Electrified accessories

Strikes

Finishes

Lever designs



Since pioneering the first exit device in 1908, Von Duprin fire life safety products have provided unparalleled quality, performance and flexibility for schools, hospitals, stadiums and public buildings.

From innovative exit devices to electronic access control solutions and accessories, Von Duprin never compromises when lives are at stake. We provide the confidence and peace of mind that at critical moments of life safety, Von Duprin exit devices will perform.



**1903**

▪ A tragic fire at the Iroquois Theater on December 30th claimed the lives of over 500 people largely due to blocked exits and lack of an emergency escape plan



**1908**

▪ Deeply moved by this tragedy Carl Prinzler and Henry Dupont invented the exit device



**1932**

▪ Drop forging technique used to manufacture exit devices with superior strength



**1957**

▪ 88 Series exit device invented, a non-handed, reversible product

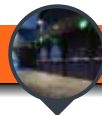

**1962**

▪ Concealed vertical rods for metal doors were introduced by Von Duprin



**1965**

▪ Release of 55 Series exit device for narrow stile doors



**1972**

▪ 33/35 Series exit device invented



**1973**

▪ Electric latch retraction introduced to provide remote unlatching of exit devices.



**1980**  
 ■ 98/99 Series exit device invented



**1993**  
 ■ Breakaway lever trim introduced to reduce damage from vandalism and abuse



**1996**  
 ■ Chexit device introduced to control delayed exit applications



**2006**  
 ■ XP device invented



**2012**  
 ■ Concealed vertical cable system released



**2013**  
 ■ M Collection decorative levers released



**2014**  
 ■ AX device released  
 ■ Allegion Connect released



**2015**  
 ■ Wood door concealed (WDC) solution released

# VON DUPRIN®

## Popular options

Von Duprin offers an array of options and accessories for both panic and fire-rated devices. Popular options shown here. For additional options, please contact Von Duprin customer care.

### Quiet electrified latch (QEL)

#### Whisper quiet access control

Some environments require both access control and extreme quiet. The Von Duprin quiet electrified latch (QEL) reduces operational noise down to a whisper. Designed with advanced sensing electronics, the QEL is the next generation of quiet dependable latch retraction from Von Duprin.

- Available for 98/99, 94/95 and 33A/35A Series devices
- Reduced power requirements allow for wire run between power supply and device can now be up to 800 ft.
- Quiet operation both electrically and mechanically
- Installation and troubleshooting diagnostics built into device
- Automatic calibration mode – self-adjusts latch bolt pull and throw
- Powered by a 2 amp power supply



### Security Indicators

Designed to provide at-a-glance verification of door status from inside of the room. Ideal for environments, such as schools and hospitals. These products meet fire and life safety codes for free egress and are recommended for the following applications:

- Visual Verification - Reduce the time it takes to tour your facility and ensure each door is secure by installing the Von Duprin security indicator to provide at-a-glance visual verification.
- Lockdown - Lock down high occupancy areas such as auditoriums, cafeterias and gymnasiums, from inside the room with the Von Duprin security indicator that provides positive visual confirmation.

#### -2SI security indicator

- 2SI security indicator with double cylinder
- At-a-glance verification of the locked/unlocked status of the door from inside of the room
- Thumbturn or key cylinder with lock/unlock labels provide a clear direction of rotation to secure opening
- Available for 98/99 Series rim devices and as retrofit conversion kit

#### CDSI/HDSI dogging indicator

- Hex or cylinder dogging options
- Visual indication of whether the exit device is dogged or undogged.
- Available for 98/99 & 33A/35A Series panic devices
- Available on various device types – rim, mortise and vertical systems



Von Duprin HDSI Indicator

Von Duprin CDSI Indicator

Von Duprin -2SI Indicator

### Concealed vertical cable system

Our patented concealed cable system eliminates the challenges of installing and maintaining traditional concealed rods. Designed for use with Von Duprin 98/99 and 33/35A series exit devices, the CVC system provides more secure protection for the opening, and delivers the streamlined aesthetics that architects and customers prefer.

- Can be ordered pre-installed in Steelcraft doors
- Stainless steel cables prevent corrosion and increase system strength
- Top latch with greater than 90-degree bolt-to-strike engagement enhances security
- Bottom latch height adjustable with door hanging
- Latches operate independently, allowing the top latch to reliably engage even if the bottom latch is compromised
- Available for fire and non-rated applications



## Popular options

### Delayed egress solutions - CHEXIT, RCM and DE5300

The CHEXIT device sounds an alarm and keeps the door secured for 15 seconds following an exit attempt with immediate release upon fire alarm or power failure. Numerous configurable settings allow the CHEXIT to be customized based on specific application or code requirements.



Key switch to arm, disarm or reset. Flashing indicator displays status.



#### RCM / DE5300

Designed to provide the concept of the Chexit delayed exit system for door sizes smaller than the standard device can accommodate.

- Available on all 98/99 XP, 98/99 and 33A/35A series exit devices
- Motor driven blocking actuator provides quiet and energy efficient operation
- Flexible field configurable functions, including: nuisance delay 0, 1, 2 or 3 seconds, audio sound level high/low, power up setting armed/disarmed
- RCM and DE5300 available to accommodate a variety of door configurations and applications
- UL 294 Listed and meets 2015 IBC 1010.1.9.7 Delayed Egress and 1010.1.9.6 Controlled Egress and NFPA 72.1.6 Special Locking Arrangements



### Wood door concealed cable system (WDC) Concealed one and two point latches for wood door applications

Wood doors are the “finishing touch” for many installations. It is only appropriate that the corresponding door hardware lives up to this expectation. The Von Duprin WDC series provides a new paradigm for wood door hardware – one free from unsightly metal wraps and large escutcheons, one where installation becomes as simple as winding a cable on a reel, and where enhanced security and reliability blend seamlessly with the opening.

- Fire-rated applications without the use of metal wraps (up to 60 minute rating)
- Aesthetics: 31 available lever designs with sectional and escutcheon trim options combined with suiting across multiple Schlage and Von Duprin platforms allow for a consistent look throughout your facility.
- Available for narrow stile doors (33/3550A-WDC) and 98/9950WDC series exit devices for wide stile doors.

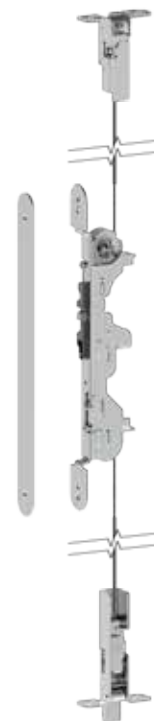

### Keyed removable mullion



Mullions provide single door performance and security on double door applications. A keyed removable mullion makes removal faster and easier by a single operation of the mortise cylinder. Once the mullion is removed, large equipment or furniture can freely pass through the opening. The unit will self-lock when re-installed without use of the cylinder key.

The lock assembly is available on standard or fire labeled steel mullions, and can be purchased separately for retrofitting. Uses standard 1<sup>3</sup>/<sub>4</sub>” mortise cylinder (not included).

- UL/cUL listed for fire exit hardware (GXHX) A label
- Available to suit multiple opening heights
- Provide single door performance in double door openings with rim devices
- Unit self locks when re-installed, without use of the cylinder key

# VON DUPRIN®

## 98/99 Series heavy duty pushpad exit device



First to market with many patented innovations, such as concealed vertical cables (CVC), a 5 lb. accessible device (AX) and motor driven quiet electric latch retraction (QEL), Von Duprin 98/99 series devices continue to drive the industry forward. They are designed and tested to the highest standards. These ANSI/BHMA Grade 1 certified devices are put to the ultimate test every day in thousands of schools, hospitals and government buildings around the globe. Whatever your requirement might be, Von Duprin has a solution to meet your needs with the widest range of mechanical around electromechanical options on the market.

98/99 Series exit devices incorporate modern pushbar styling for heavy traffic applications. The 98 and 99 series devices have the same functionality, just different design elements. The 98 has a smooth mechanism case, while the 99 has a grooved mechanism case. Available in rim, mortise lock, surface and concealed vertical cable mountings and rim/surface vertical rod combination.

- Designed for use on flush and wide stile doors as narrow as 4 1/2".
- Devices are UL/cUL Listed panic hardware (FVSR) SA163.
- Fire devices (F) are UL/cUL Listed fire exit hardware (GXHX) R4504, A label.
- Tested in accordance to ANSI A156.3, Grade 1.
- Finishes include US3, US4, US10, US26, US26D, US28, 313 and 315.
- US15 and US32D finish available on 98 Series.



98 Series features a smooth mechanism case



99 Series features a grooved mechanism case

**The Quiet One®**  
Furnished standard on Series 98/99 and 33A/35A exit devices. A damper decelerates the push pad on its return stroke and eliminates most noise associated with exit device operation.

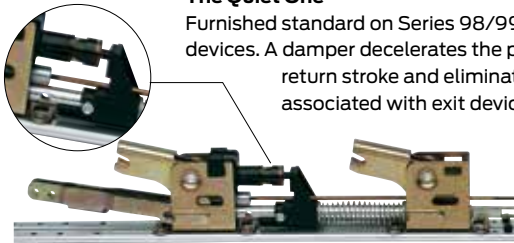

### XP Extra performance

For applications that demand increased security, the XP98/99 Rim exit device has a static load force resistance of more than 2,000 pounds, twice that of standard rim exit devices. This design enables the exit door to withstand an external attack and remain secure. XP98/99 is available for panic or fire exit hardware applications.

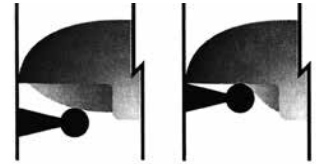

## Options and accessories

Von Duprin exit devices are built to meet the needs of your project. See below for a condensed list of options that are available to complement your application.

### QEL quiet electric latch retraction

Quiet electric latch retraction (QEL) provides electronic control of an exit device for environments where limited operational noise is desired. May be applied to fire devices when under the control of an automatic fire alarm system.

### Electric mortise lock

The E7500 option provides for remote locking or unlocking of the outside trim without retracting the latchbolt. Particularly useful as a fail-safe component of an automatic fire alarm system.

### Glass bead kit

Available for use on doors with raised glass beads.

### Pneumatic latch retraction

Provides remote access unlocking control in hazardous areas. The air cylinder used in the device has a special actuating linkage that allows a mechanical override.

### Electronic switches - Request to exit and latchbolt monitoring

**Request to exit:** Used to signal egress of an opening. Devices are equipped with one internal SPDT switch which monitors the touch bar.

**Latchbolt monitor:** The LX (latchbolt monitor switch) option is used to signal both egress and access of an opening. These devices are equipped with one internal SPDT switch which monitors the latchbolt.

### Signal switch

Signals unauthorized use of an opening. One internal switch monitors the touch bar and the latchbolt for positive security. A second internal switch is controlled by the key cylinder for alarm shunt and reset. The SS device is designed to work with additional alarm components.

### ALK Alarm kit

A simple yet effective way to monitor the use of an exit. The unit contains an internal horn which operates on one 9V battery. Optional power supplies available.

### Connect

Allegion's cross-category Connect features common interconnect components to our electrified options. Allegion Connect is a quick and easy way to connect power sources; all the way from your power supply to locking device.

### AX - Accessible device

The AX device is a UL certified exit device designed to meet the progressive requirements of the California Building Code for accessible openings. This device meets the 5 lbs of operating force requirement called for in chapter 11B-309.4. The AX device also exceeds ANSI/BHMA requirements.

### Cylinder dogging

Available on all 98/99 panic devices to replace the standard hex key dogging. Unit requires a standard 1 1/4" (32mm) mortise cylinder.





## 98/99 Series trim options

### Lever design options

Von Duprin offers an array of lever designs and finishes to meet your project needs. The ability to suite our levers across multiple platforms from Von Duprin and Schlage means you will get consistent style and functionality—along with unrivaled security. Popular designs shown below. For additional options, see page 131.



03



06 (standard)



12



17



M51



M63



M81



M85

### Trim options

Von Duprin offers an array of trim functions and formats for both panic and fire-rated devices. Popular designs shown here. For additional options, please contact Von Duprin customer care.



990-TP



996L

#### Breakaway™ lever trim

The Breakaway Lever trim Series 996L significantly reduces damage from vandalism, while maintaining ADA standards. When excess force is applied, the lever trim appears to break. Later it can be easily reset, saving the cost of replacement.

#### Electric locking/unlocking trim

E996L lever trim provides remote unlocking and locking capabilities. Often used in the control of stairwells in high-rise buildings.



696



697



996K

Von Duprin understands that you often go to great lengths to make your projects one of a kind and inviting. We also realize you have spaces that are personal and have unique requirements. To enhance your projects functionality and personality we offer an array of finishes, functions and custom options to meet your requirements. Contact Von Duprin customer care to learn how we can help solve your application needs.

EXPERT TIPS

## Visual indicators



Von Duprin HDSI Indicator



Von Duprin CDSI Indicator



Von Duprin -2SI Indicator

Several Allegion brands have products equipped with visual indicators. This innovative feature immediately alerts a user about a door's locked or unlocked status. The convenience of using at-a-glance indicators to assess a lock saves time and alleviates confusion in the event of an emergency.

- Used for openings in classrooms, corridors, gymnasiums and other occupancy spaces
- At-a-glance verification of the lock status from inside a room



Schlage L-Series Indicator

# VON DUPRIN®

## 33A/35A Series narrow stile heavy duty pushpad exit device

33A/35A Series exit devices incorporate contemporary design and durability. The 33A and 35A devices have the same functionality, just different design elements. The 33A has a grooved mechanism case, while the 35A has a smooth mechanism case. Available in rim, surface and concealed vertical rod mountings. For all types of doors, even door stiles as narrow as 1<sup>3</sup>/<sub>4</sub>". Deadlocking latchbolt is standard.

- Devices are UL/cUL Listed panic hardware (FVSR) SA163.
- Fire devices (F) are UL/cUL Listed fire exit hardware (GXHX) R4504, A label.
- Tested in accordance to ANSI A156.3, Grade 1.
- Deadlocking latchbolt is standard on 33A/35A.
- Finishes include US3, US4, US10, US26, US26D, US28, 313 and 315.
- US15 finish available on 35A Series.



33A Series features a grooved mechanism case.



35A Series features a smooth mechanism case.

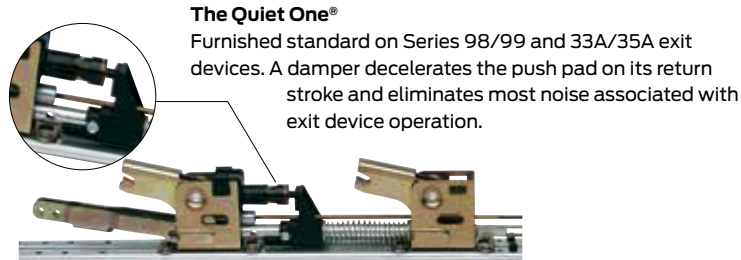

### The Quiet One®

Furnished standard on Series 98/99 and 33A/35A exit devices. A damper decelerates the push pad on its return stroke and eliminates most noise associated with exit device operation.

### Deadlocking latchbolt

Provides security and improved performance at standard device cost.

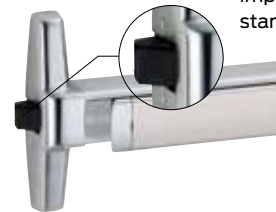

## Options and accessories

Von Duprin exit devices are built to meet the needs of your project. See below for a condensed list of options that are available to complement your application.

### QEL quiet electric latch retraction

Quiet electric latch retraction (QEL) provides electronic control of an exit device for environments where limited operational noise is desired. May be applied to fire devices when under the control of an automatic fire alarm system.

### Electronic switches - Request to exit and latchbolt monitoring

**Request to exit:** Used to signal egress of an opening. Devices are equipped with one internal SPDT switch which monitors the touch bar. **Latchbolt monitor:** The LX (latchbolt monitor switch) option is used to signal both egress and access of an opening. These devices are equipped with one internal SPDT switch which monitors the latchbolt.

### Connect

Allegion's cross-category Connect features common interconnect components to our electrified options. Allegion Connect is a quick and easy way to connect power sources; all the way from your power supply to locking device.

### AX - Accessible device

The AX device is a UL certified exit device designed to meet the progressive requirements of the California Building Code for accessible openings. This device meets the 5 lbs of operating force requirement called for in chapter 11B-309.4. The AX device also exceeds ANSI/BHMA requirements.

### Signal switch

Signals unauthorized use of an opening. One internal switch monitors the touchbar and the latchbolt for positive security. A second internal switch is controlled by the key cylinder for alarm shunt and reset. The SS device is designed to work with additional alarm components.

### Alarm kit

A simple yet effective way to monitor the use of an exit. The unit contains an internal horn and operates on one 9V battery. Optional power supplies available.

### Cylinder dogging

Available on all 33A/35A devices to replace the standard hex key dogging. Unit requires a standard 1<sup>1</sup>/<sub>4</sub>" (32mm) mortise cylinder.

## Photoluminescent touch bar

The Von Duprin "safety glow" coating is a specially designed powder-coat finish that displays a luminescent glow during low or no light conditions. When exposed to normal ambient light, the coating produces a recognizable glow, directing building inhabitants to pathways of safety.

E  
X  
P  
E  
R  
T  
T  
I  
P



Available for 98/99 and 33A/35A Series.

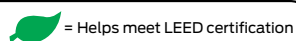
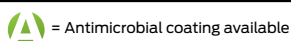

## 33A/35A Series trim options



### Lever design options

Von Duprin offers an array of lever designs and finishes to meet your project needs. The ability to suite our levers across multiple platforms from Von Duprin and Schlage means you will get consistent style and functionality—along with unrivaled security. Popular designs shown below. For additional options, see page 131.



03



06 (standard)



12



17



M51



M63



M81



M85

### Trim options

Von Duprin offers an array of trim functions and formats for both panic and fire-rated devices. Popular designs shown here. For additional options, please contact Von Duprin customer care.



360L



360T  
(with optional pull)



374  
(with optional pull)



386



388  
(with optional pull)

Von Duprin understands that you often go to great lengths to make your projects one of a kind and inviting. We also realize you have spaces that are personal and have unique requirements. To enhance your projects functionality and personality we offer an array of finishes, functions and custom options to meet your requirements. Contact Von Duprin customer care to learn how we can help solve your application needs.



For high traffic applications, turn to Von Duprin for recessed devices designed specifically to reduce impact. INPACT™ 94 and 95 series devices are fully integrated within a door to protect it from abuse and provide superior durability and performance. The 94 and 95 have the same functionality, just different design elements. The 94 has a smooth mechanism case, while the 95 has a grooved mechanism case. Both low profile devices are compatible with hollow metal doors and commonly used in hospitals and other facilities where openings must accommodate a high volume of people and equipment. For challenging applications such as these, turn to Von Duprin for industry leading quality, reliability and durability.

All INPACT exit devices are as durable as they are functional. The heavy-duty construction, simple mechanical design and Von Duprin's legendary commitment to quality combine to ensure a long, trouble-free service life.

- Devices are UL/cUL Listed panic hardware (FVSR) SA163.
- Fire devices (F) are UL/cUL Listed fire exit hardware (GXHX) R4504, A label.
- Tested in accordance to ANSI A156.3, Grade 1.
- These devices exceeded one million cycles in testing.
- Finishes: US3, US4, US10, US26, US26D, US28 and 313.



94 Series exit device shown. Series 95 exit devices feature a grooved surface. Available in concealed vertical rod and mortise lock mountings.

### Options and accessories

#### QEL quiet electric latch retraction

Quiet electric latch retraction (QEL) provides electronic control of an exit device for environments where limited operational noise is desired. May be applied to fire devices when under the control of an automatic fire alarm system.

#### Latchbolt monitor

The LX (latchbolt monitor switch) option is used to signal both egress and access of an opening. These devices are equipped with one internal SPDT switch which monitors the latchbolt.

#### Less bottom rod

The less bottom rod (LBR) option is available. In lieu of a bottom rod and latch, a spring-loaded auxiliary fire pin is installed in the lower door edge.

#### AX - Accessible device

The AX device is a UL certified exit device designed to meet the progressive requirements of the California Building Code for accessible openings. This device meets the 5 lbs of operating force requirement called for in chapter 11B-309.4. The AX device also exceeds ANSI/BHMA requirements.

E  
X  
P  
E  
R  
T  
  
T  
I  
P

## Ensure safe passage in cross-corridor applications

Properly functioning doors, locks and security systems are just a part of a safe, secure hospital environment. With the INPACT low profile exit device, you also ensure smooth, safe passage of patients, staff and equipment through cross-corridor double doors.

The INPACT exit device is recessed in the door and has a minimal projection from the door's surface. This creates more room in the passage and prevents clothing and equipment from snagging on the device. A wide pushpad makes operation easy, even for people with disabilities. And because the INPACT device is built to meet the strictest building codes, you can be sure it will stand up to the heavy use and abuse of the healthcare environment.



## INPACT® 94/95 Series trim options



### Lever design options

Von Duprin offers an array of lever designs and finishes to meet your project needs. The ability to suite our levers across multiple platforms from Von Duprin and Schlage means you will get consistent style and functionality—along with unrivaled security. Popular designs shown below. For additional options, see page 131.



02  
- Knurling available



03  
- Knurling available



06 (standard)  
- Knurling available



17  
- Knurling available



M51



M63



M81



M85

### Trim options

Von Duprin offers an array of trim functions and formats for both panic and fire-rated devices. Popular designs shown here. For additional options, please contact Von Duprin customer care.



376



550DT



940

Von Duprin understands that you often go to great lengths to make your projects one of a kind and inviting. We also realize you have spaces that are personal and have unique requirements. To enhance your projects functionality and personality we offer an array of finishes, functions and custom options to meet your requirements. Contact Von Duprin customer care to learn how we can help solve your application needs.

## EXPERT TIP Allegion Connect

Allegion Connect is a cross-category electrified solution utilizing common interconnect components to our electrified options. Allegion Connect is a quick and easy way to connect power sources; all the way from your power supply to electrified door hardware. There is no wire cutting; reducing installation and maintenance time ultimately cutting cost.

- Quick: common connections reducing installation time
- Interchangeable: all Allegion Connect products utilize the same connectors
- Available for: Von Duprin and Falcon exit devices, Schlage locks, Electric strikes, Electric power transfers, IVES hinges



# VON DUPRIN®

## 55 Series/88 Series heavy duty crossbar exit device



For superior aesthetics, turn to Von Duprin the inventor of the first crossbar exit device. The 55 series and 88 series have the same functionality, just different dimensions and design elements. The 55 series is a narrow stile device and the 88 series is wide stile. 55 series devices are commonly used in retro-inspired architecture and historical buildings due to their authentic timeless design and attention to detail. The 88 series is a standard device for applications where a crossbar is preferred. For style and performance, turn to Von Duprin for devices designed to stand the test of time.

- Tested in accordance to ANSIA156.3, Grade 1.
- Devices are UL/cUL Listed panic hardware (FVSR) SA163.
- Fire devices (F) are UL/cUL Listed fire exit hardware (GXHX) R4504, A label.
- Finishes include US3, US4, US10, US10B, US26, US26D and SPBLK.

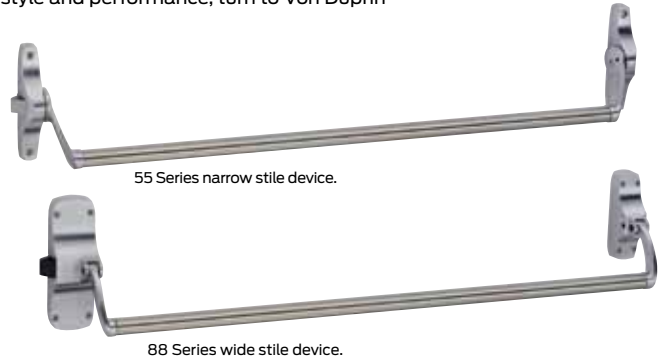

### Options and accessories

#### Request to exit switch

Used to signal egress of an opening. Devices are equipped with one internal SPDT switch which monitors the crossbar.

#### Electric mortise lock

The E8875 option provides for remote locking or unlocking of the outside trim without retracting the latchbolt. Particularly useful as a fail-safe component of an automatic fire alarm system.

### Trim options

Von Duprin offers an array of trim functions and formats for both panic and fire-rated devices. Popular designs shown here. For additional options, please contact Von Duprin customer care.

#### 55 Series



#### 88 Series



Von Duprin understands that you often go to great lengths to make your projects one of a kind and inviting. We also realize you have spaces that are personal and have unique requirements. To enhance your projects functionality and personality we offer an array of finishes, functions and custom options to meet your requirements. Contact Von Duprin customer care to learn how we can help solve your application needs.

### Lever design options

Von Duprin offers an array of lever designs and finishes to meet your project needs. The ability to suite our levers across multiple platforms from Von Duprin and Schlage means you will get consistent style and functionality—along with unrivaled security. Lever designs shown below.

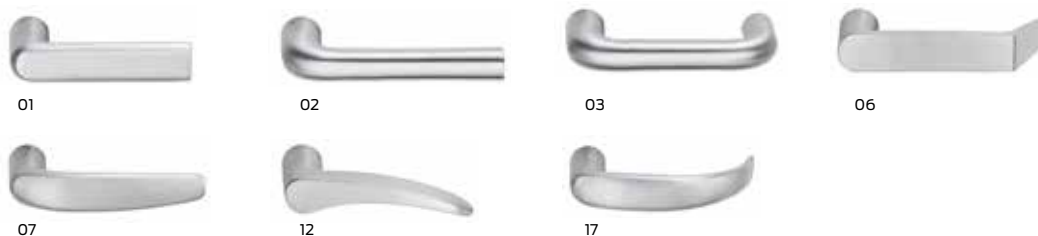

## 22 Series Medium duty push pad exit device



To maximize value, turn to Von Duprin® for medium duty push pads with the right features for your application and budget. 22 series devices have the Von Duprin quality construction you trust with a streamlined offering of options. The 22 series wide stile devices provide coverage for most standard applications. Available in several rim and surface vertical configurations combined with electronic options, Grade 1 certification and UL fire ratings.

- Devices are UL/cUL Listed panic hardware (FVSR) SA163
- Fire devices (F) are UL/cUL Listed fire exit hardware (GXHX) R4504, A label
- Tested in accordance to ANSI A156.3, Grade 1



22 Series exit device.

### Options and accessories

Von Duprin exit devices are built to meet the needs of your project. See below for a condensed list of options that are available to complement your application.

#### RX

The RX (Request to exit) feature is used to signal the use of an opening. The device can be connected to a security console, or may be used as a single door alarm when used with a horn and power supply.

#### Connect

Allegion's cross-category Connect features common interconnect components to our electrified options. Allegion Connect is a quick and easy way to connect power sources; all the way from your power supply to locking device.

#### AX - Accessible device

The AX device is a UL certified exit device designed to meet the progressive requirements of the California Building Code for accessible openings. This device meets the 5 lbs of operating force requirement called for in chapter 11B-309.4. The AX device also exceeds ANSI/BHMA requirements.

#### ALK alarm kit

Exit alarm kits are a simple yet effective way to monitor the use of an exit. The unit contains an internal horn which operates on one 9V battery. Optional power supply available.

Von Duprin understands that you often go to great lengths to make your projects one of a kind and inviting. We also realize you have spaces that are personal and have unique requirements. To enhance your projects functionality and personality we offer an array of finishes, functions and custom options to meet your requirements. Contact Von Duprin customer care to learn how we can help solve your application needs.

### Trim options

Von Duprin offers an array of trim functions and formats for both panic and fire-rated devices. Popular designs shown here. For additional options, please contact Von Duprin customer care.



### Lever design options

Von Duprin offers an array of lever designs and finishes to meet your project needs. The ability to suite our levers across multiple platforms from Von Duprin and Schlage means you will get consistent style and functionality—along with unrivaled security. Lever designs shown below.



## GUARD-X Deadbolt Alarmed exit device

The Von Duprin Series 2670 GUARD-X provides secure, alarmed, code-compliant protection for secondary exits. The GUARD-X exit alarm lock readily identifies the door on which it is mounted as an emergency exit and secures the opening against unauthorized use. It is ideal for deterring theft in restaurants and retail establishments such as discount stores, grocery stores, drug stores, clothing stores and sporting goods stores.

- UL/cUL Listed for panic exit hardware.
- Complies with NFPA 101 life safety code.
- Meets UL305 requirements and ANSI A156.3, Grade 1.
- Stainless steel deadbolt is 2" x 1/2" (51mm x 13mm) with more than 3/4" (19mm) throw.
- 100-decibel alarm.
- Armed and disarmed by a key using a standard rim cylinder.
- Can be operated from building exterior.
- Surface-mounted 210DT or 230DT pull trim can be mounted above or below device centerline.
- Finishes include US28 (aluminum), 313AN (duranodic brown) and 315AN (black).



Guard-X device

# VON DUPRIN®

## Power transfer/Strikes



### Power transfers

UL/cUL Listed for Class 2 low voltage installation of electric latch retraction feature on 33A, 35A, 98 and 99 Series exit devices. Provides 180° door swing with 5" butt hinges and 3/4" offset pivots. When door is closed, unit is completely concealed for tamper resistance. Available in two wire (EPT2) and ten wire (EPT10) formats.

A pneumatic transfer is available; function and appearance are the same. UL/cUL Listed as "miscellaneous fire door accessory."

### Electric strikes

Electric strikes are used as part of many electronic access control systems to provide added security and conveniences such as traffic control and remote release. We offer a complete portfolio of electric strikes to address the unique needs of your application. Our products are designed to meet the highest standards in the industry for reliability, durability and security. For aftermarket applications we offer a variety of strikes with field selectable options including power failure mode and voltage to provide you with maximum flexibility. We also have a complete offering of highly customizable strikes ideal for new construction applications.

To select the proper strike it is important to determine the type of door hardware in use. The electric strike interfaces with the latch bolt of the door hardware. Together the strike and door hardware secure the door. Therefore you must ensure that the strike can accommodate both the dimension and position of the bolts.

#### Strikes compatible with exit devices include:

##### Von Duprin 6100 Series strike

- Wide breadth of factory customizable options for virtually any application
- Heavy-duty, stainless steel construction
- For single, double, and fire-rated doors

##### Von Duprin 6300 surface mounted strike

- Field customizable for two possible configurations
- 12/24VDC field selectable voltage
- Fire-rated, field secure
- Heavy-duty stainless steel construction
- Easy to install - requires no alteration or cutting to existing frame

#### Strikes compatible with mortise and/or cylindrical locksets include:

##### Von Duprin 6200 Series strike

- Wide breadth of factory customizable options for virtually any application
- Heavy-duty, stainless steel construction
- For single, double, and fire-rated doors

##### Von Duprin 5100 Series strike

- Field customizable for twelve possible configurations
- 12/24VDC field selectable voltage
- Field convertible fail-secure/fail-safe
- Three faceplates standard for a variety of door and frame types
- Field adjustable keeper accommodates door and frame alignment issues

##### Von Duprin ES-6400 Series strike

- Field customizable for multiple possible configuration
- 12/24VDC, 12/24VAC field selectable
- All-in-one strike with field configurable deadbolt keeper and dead latch ramp to allow for alignment with a wide variety of doors and frames
- Fire-rated, field-secure

##### Von Duprin 4200 Series strike

- Flexible options for a variety of configurations
- 12/24 VDC field selectable voltage
- Field configurable power failure mode (fail-safe/fail-secure)
- Latchbolt monitoring standard on 4212 only



### Monitor strikes

Von Duprin monitor strikes are designed to offer remote door monitoring through the use of a signal switch (SPDT) mounted in the strike to monitor the latchbolt.

This series of monitor strikes is designed for use with Von Duprin exit devices and most other manufacturers' exit devices, mortise and cylindrical locks. UL/cUL Listed for fire exit hardware (GXHX) R4504.



## EXPERT TIPS

# XP = Extra protection

Use XP-strength products for a complete lock, closer and exit device solution.



### 4040XP door closer – high use, high abuse

- Strongest pinion ever with stronger pinion teeth
  - Widest bearings ever –  $\frac{5}{8}$ "
  - 44% increase in maximum load capacity
  - V-shield™: Advanced V-shield seals for extended life
  - All-weather eliminates seasonal adjustments
  - Standard heavy-duty EDA arm, standard plastic cover and self-reaming and tapping screws
- See page 92.



### Primus XP

- Unique side bit milling
  - Keyway exclusivity available by time zone or zip code
  - Patent protected until 2024 - the highest level of security for the longest period of time
  - Supports small to large key systems with multi-level hierarchy where needed
  - Ideal for areas where high security and key control are needed
- See page 57.



### XP98/99 exit device – extra protection for greater security











- Static load resistance of more than 2000 pounds
- Collapsing latch mechanism compensates for flex in the frame or mullion
- Requires 25% less force to operate than required by ANSI
- Easy to retrofit
- Ideal for openings subject to violent “pull force” attack
- See page 120 for more information.



= Helps meet LEED certification

# VON DUPRIN®

## Finishes

	Color	US number	BHMA number
	Satin nickel	US15	619
	Chromium, bright	US26	625
	Anodized, aluminum	US28	628
	Chromium, satin	US26D	626
	Stainless steel, satin	US32D	630
	Brass, bright	US3	605
	Brass, satin	US4	606
	Bronze, satin	US10	612
	Aged bronze	—	643E
	Duranodic dark bronze	313	710
	Black	315	711

- Pushpad options**
- Knurled
  - Embossed “push”
  - Braille (caution-stairwell), satin stainless steel only
  - SS – (Emergency Exit – Push to open and sound alarm) – red silkscreen lettering on US32D
  - SG - safety glow (luminescent touch pad)

\* Note: Custom powder-coated finishes available as a special. Please contact Customer Care for more information, 877-671-7011.

# VON DUPRIN®

## Lever design options

Von Duprin offers an array of standard and decorative lever designs to meet your project needs. Our levers suite across multiple platforms from Von Duprin and Schlage giving you consistent style and functionality—along with unrivaled security. Please contact Customer Care for more information, 877-671-7011.

### Standard Levers

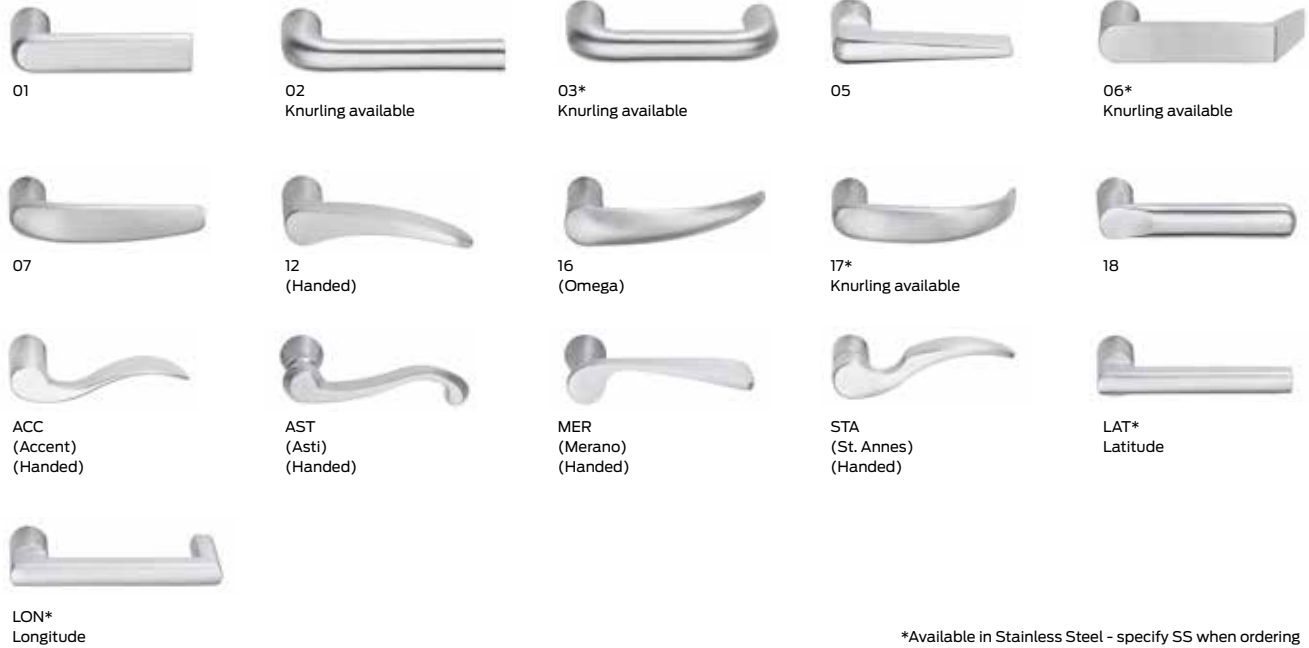

### Decorative levers



# FALCON®

Door hardware

## Contents

### Locks

#### Commercial locks

MA Series

T Series

X Series

B Series

K Series

W Series

H Series

#### Deadbolts

D100 Series

D200 Series

#### Retrofit

RU series

#### Cylinders and key systems

#### Exit devices

24 Series

25 Series

19 Series

XX Series

1690/1790 Series

1590 Series

1490 Series

2390 Series

1990 Series

2090 Series

### Accessories

#### Closers

SC70 Series

SC80 Series

SC60 Series

SC90 Series

OHC100 Closers



Falcon door hardware delivers durability, convenience and unmatched value. Falcon products include locks, cylinders, key systems, exit devices, closers and accessories providing quality products at a reasonable price. Delivering reliable performance, Falcon makes it simple - cost effective products that meet or exceed life safety and building code requirements.



## Falcon is solid

Regardless of the job, Falcon delivers reliable performance and great looks at an affordable price. Falcon products are ideal for all applications and architectural needs.

- **New construction/remodel**
- **Multi-family**
- **Retail and restaurant**
- **Office**
- **Hospitality**
- **Assisted living**
- **Schools**

# FALCON®

## Heavy-duty commercial locksets

### Heavy-duty mortise locks



#### MA Series Grade 1

- 4 lever designs, 1 knob design, 28 functions (including electrified) and 6 finishes
- UL/cUL Listed for three-hour A label doors
- Field-reversible lock case and trim
- Through-bolted trim eliminates binding caused by misalignment
- Independent, heavy-duty return springs eliminate lever sag
- 1" (25mm) projection deadbolt with hardened steel, free-turning saw-resistant inserts
- ¾" (19mm) throw anti-friction latch bolt
- Compatible with conventional and SFIC cylinders



New lever styles will be available in late 2016: Broadway, Boardwalk, Latitude, and Longitude.

### Falcon lock with indicator.

The Falcon MA Mortise Lock with an indicator.



### Heavy-duty cylindrical locks



#### K Series Grade 1

- Certified ANSI/BHMA Grade 1 for quality and reliability
- Clutching lever design allows the lever to move when locked without unlatching the door, preventing damage to the chassis
- Four through bolts for added strength, providing high security and peace of mind.
- Lever security caps to help prevent undesired lever removal and lever sag after continual use.

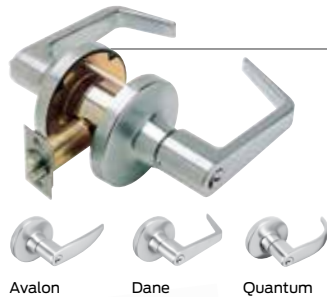

New lever styles will be available in late 2016: Broadway, Boardwalk, Latitude, and Longitude.

#### T Series Grade 1

- 3 lever designs, 15 functions (including electrified) and 5 finishes
- UL/cUL Listed for three-hour A label doors
- Meets ADA requirements
- Non-handed through-bolted cylindrical chassis
- Designed for high use applications
- PressureRelease™ lever stands up to heavy abuse and resists vandalism
- Double stainless steel compression springs eliminate lever sag
- Accepts virtually all competitors' standard cylinders and interchangeable cores



#### X Series Grade 1

- 3 knob designs, 10 functions and 6 finishes
- UL/cUL Listed for three-hour A label doors
- Field reversible cylindrical chassis
- Available in a stainless steel configuration; ideal for corrosive and marine environments
- Compatible with conventional and SFIC cylinders

#### Finishes

Not all products available in all finishes. Please consult your Allegion representative for more information. \*Available in late 2016

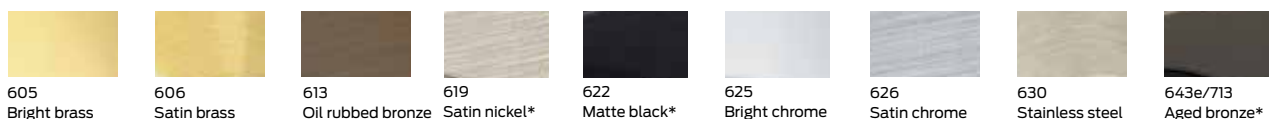

## Medium duty commercial locksets

### Medium duty cylindrical locks



#### B Series Grade 2

- 2 lever designs, 10 functions and 5 finishes
- UL/cUL Listed for 3-hour A label doors
- Meets ADA requirements
- Non-handed through-bolted cylindrical chassis
- Independent, heavy-duty return springs eliminate lever sag
- 3 1/2" (89mm) diameter rose provides design compatibility with T Series Grade 1 lever lockset
- Compatible with conventional and SFIC cylinders



#### W Series Grade 2

- 2 lever designs, 10 functions and 5 finishes
- 2 knob designs, 7 functions and 5 finishes
- 2 roses available - 3 1/2" and 2 9/16" diameters
- UL/cUL Listed for three-hour A label doors
- Meets ADA requirements
- Non-handed chassis, with optional through-bolting
- Schlage C and Falcon master-keyed available
- SFIC master-keyed
- Excellent performance for price value
- Heavy-duty springs for better lever return
- New small rose lever design



New lever styles will be available in late 2016: Broadway, Boardwalk, Latitude, and Longitude.

### Interconnected locks

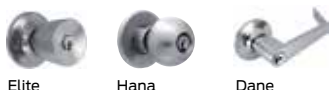

#### H Series

- 2 knob designs, 1 lever design, 4 functions and 3 finishes
- UL/cUL Listed for 1 1/2 hour B label doors
- Lever style trim meets ADA requirements
- 1" (25mm) projection deadbolt with hardened steel, free-turning saw-resistant insert
- Deadbolt available with ADA ("K" suffix) turnpiece design
- Compatible with conventional and SFIC cylinders

# FALCON®

## D Series Grade 1 and 2 commercial deadbolts

### Deadbolts



#### D100 Series Grade 1

- 5 functions and 5 finishes
- Barrier-free turnpiece design
- 1" (25mm) projection deadbolt with high strength steel, free-turning saw-resistant insert
- Integrated anti-pry shield behind cylinder for added security and quicker installation
- Adjustable backset with lock-in place design for greater versatility
- Compatible with conventional and SFIC cylinders"



#### D200 Series Grade 2

- 8 functions and 5 finishes
- 1" (25mm) projection deadbolt with hardened steel, free-turning saw-resistant insert
- Attaches to door with hardened steel through-bolts
- Integrated anti-pry shield behind cylinder for added security and quicker installation
- Adjustable backset with lock-in place design for greater versatility
- Compatible with conventional and SFIC cylinders"



D261      D271      D261M

### Unit lock retrofit locks



#### RU Series Grade 1

- 2 lever designs, 12 functions and 2 finishes
- Complies with ADA easy access requirements
- Preserves existing facility doors and frames
- Easy installation with minimal door modifications
- Non-handed through-bolted cylindrical chassis
- Pressure release lever stands up to heavy abuse and resists vandalism
- Independent heavy-duty return springs eliminate lever sag
- Accepts virtually all competitors' standard cylinders and interchangeable cores
- Strikes available to match existing frame preparation
- Features a 4" (102mm) square rose which covers all existing mounting holes, most paint lines and required door rework



Dane      Quantum

### Cylinders and key systems



#### Small format interchangeable core cylinders and key systems

- 6-pin and 7-pin customized multi-level master key systems
- Small format (Best style) interchangeable core (SFIC)
- Available in most Best keyways
- Optional geographically restricted keyways for greater key control
- Broad line of supporting locksets
- Full line of service equipment

#### Conventional cylinders and key systems

- 5-pin, 6-pin and 7-pin customized multi-level master key systems
- Full line of supporting locksets
- Popular keyways of other manufacturers
- Optional restricted keyways for greater key control
- Conventional cylinder Schlage C keyway, master key available



## EXPERT TIPS

# 24 Series and 25 Series heavy-duty touchbar exit devices

Offices, banks, assisted living facilities, retail stores and other commercial buildings have constant traffic, so door hardware must be able to take continual use and abuse. The Falcon 24 Series and 25 Series exit devices fit the bill with some of the toughest, most reliable performance in the business. A host of features makes this a smart solution, like a choice of an A or B label fire rating, electrified and panic options, and a full complement of trims. Sleek, streamlined styling and a choice of standard (25 Series) and narrow stile (24 Series) devices means the 24 and 25 Series fit your building design, as well as its use. And since they're backed by one of the best names in the business, you can be sure you're getting the utmost value, reliability and durability.

- Offices
- Assisted living
- Retail
- Restaurants
- Worship
- Hospitality
- New construction or remodel



# FALCON®

## Heavy duty touchbar exit devices

### 24 Series

The 24 Series exit device has a sleek design that is ideal for narrow door stiles. Attractive narrow stile trim options are also available to meet many entrance requirements. Available in panic exit or fire exit construction, Available finishes include: US3, US4, US10, US15\*, US19\*, US26, US26D, US28, US32, US32D, 710/313AN, 643e/716\*.

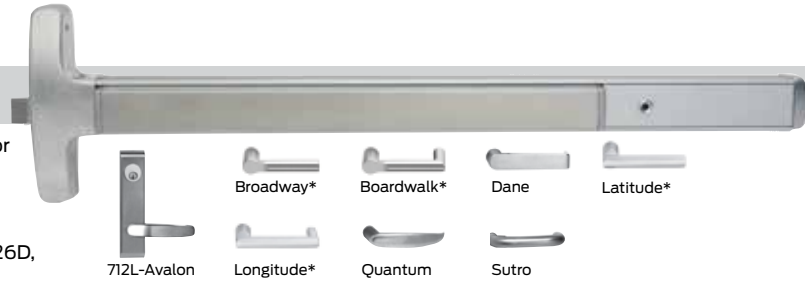

\*Available in late 2016

Functions (ANSI)		24-R*	24-V*	24-C*
<b>EO</b> (01)	Exit only, no trim.	(F)-24-R-EO	(F)-24-V-EO	(F)-24-C-EO
<b>DT</b> (02)	Entrance by trim when actuating bar is locked down.**	(F)-24-R-DT	(F)-24-V-DT	(F)-24-C-DT
<b>C or NL</b> (03)	Entrance by trim when latchbolt is retracted by key. Key only removable when locked.**	(F)-24-R-NL or C	(F)-24-V-NL or C	(F)-24-C-NL or C
<b>TP</b> (05)	Entrance by thumbpiece. Key locks or unlocks thumbpiece.	(F)-24-R-TP	(F)-24-V-TP	(F)-24-C-TP
<b>TP(NL)</b> (06)	Entrance by thumbpiece only when released by key. Key only removable when locked.	(F)-24-R-TP(NL)	(F)-24-V-TP(NL)	(F)-24-C-TP(NL)
<b>L or K</b> (08)	Entrance by knob or lever. Key locks or unlocks knob.	(F)-24-R-L or K	(F)-24-V-L or K	(F)-24-C-L or K
<b>L (NL) or K (NL)</b> (09)	Entrance by knob or lever only when released by key. Key removable only when locked.	(F)-24-R-K(NL) or L(NL)	(F)-24-V-L(NL) or K(NL)	(F)-24-C-L(NL) or K(NL)
<b>TLP or TL</b> (11)	Entrance by control turnpiece. Key locks or unlocks control.	-	(F)-24-V-TL	(F)-24-C-TLP or TL
<b>TLP (NL) or TL (NL)</b> (12)	Entrance by control turnpiece only when released by turning key. Key removable only when locked.	-	(F)-24-V-TL(NL)	(F)-24-C-TLP(NL) or TL(NL)

\*R – rim, type 1, 4 · V – vertical rod, type 2, 6 · C – concealed vertical rod, type 6, 7, 8 (Specify - WDC for wood door concealed)

\*\*Note: Fire exit devices cannot be dogged down. Some codes permit electric dogging and/or electric latch retraction with fail-secure circuitry.

### 25 Series

The 25 Series is designed to allow for maximum flexibility for both mechanical and electrical applications. All 25 Series devices are available in panic exit or "A" label (3 hr.) fire exit construction. Available finishes include: US3, US4, US10, US15\*, US19\*, US26, US26D, US28, US32, US32D, 710/313AN, 643e/716\*.



\*Available in late 2016

Functions (ANSI)		25-R*	25-V*	25-M*	25-C*
<b>EO</b> (01)	Exit only, no trim.	(F)-25-R-EO	(F)-25-V-EO	(F)-25-M-EO	(F)-25-C-EO
<b>DT</b> (02)	Entrance by trim when actuating bar is locked down.**	(F)-25-R-DT	(F)-25-V-DT	(F)-25-M-DT	(F)-25-C-DT
<b>C or NL</b> (03)	Entrance by trim when latchbolt is retracted by key. Key only removable when locked.**	(F)-25-R-NL or C	(F)-25-V-NL or C	(F)-25-M-NL or C	(F)-25-C-NL or C
<b>TP</b> (05)	Entrance by thumbpiece. Key locks or unlocks thumbpiece.	(F)-25-R-TP	(F)-25-V-TP	(F)-25-M-TP	(F)-25-C-TP
<b>TP (NL)</b> (06)	Entrance by thumbpiece only when released by key. Key only removable when locked.	(F)-25-R-TP(NL)	(F)-25-V-TP(NL)	(F)-25-M-TP(NL)	(F)-25-C-TP(NL)
<b>TP (2)</b> (07)	Entrance by thumbpiece. Inside key locks or unlocks thumbpiece. Outside key retracts latch.	(F)-25-R-TP(2)	(F)-25-V-TP(2)	(F)-25-M-TP(2)	(F)-25-C-TP(NL)
<b>TP (2 O.C.)</b> (07)	Double outside cylinder. One unlocks thumbpiece/trim, the other cylinder retracts latchbolt.	(F)-25-R-TP(2 O.C.)	(F)-25-V-TP(2 O.C.)	-	-
<b>L or K</b> (08)	Entrance by knob or lever. Key locks or unlocks knob.	(F)-25-R-L or K	(F)-25-V-L or K	(F)-25-M-L or K	(F)-25-C-L or K
<b>L (NL) or K (NL)</b> (09)	Entrance by knob or lever only when released by key. Key removable only when locked.	(F)-25-R-L(NL) or K(NL)	(F)-25-V-L(NL) or K(NL)	(F)-25-M-L(NL) or K(NL)	(F)-25-C-L(NL) or K(NL)
<b>L (2) or K (2)</b> (10)	Entrance by knob or lever. Inside key locks or unlocks knob. Outside key retracts latch.	(F)-25-R-L(2) or K(2)	(F)-25-V-LP(2)	(F)-25-M-L(2) or K(2)	-
<b>L (2 O.C.) or K (2 O.C.)</b> (10)	One cylinder locks or unlocks knob. Other cylinder retracts latch.	(F)-25-R-L(2 O.C.) or K(2 O.C.)	(F)-25-V-L(2 O.C.)	-	-
<b>TLP or TL</b> (11)	Entrance by control turnpiece. Key locks or unlocks control.	-	(F)-25-V-TL	-	(F)-25-C-TL or TLP
<b>TLP (NL) or TL (NL)</b> (12)	Entrance by control turnpiece only when released by turning key. Key removable only when locked.	-	(F)-25-V-TL(NL)	-	(F)-25-C-TL(NL) or TLP(NL)

\*R – rim, type 1 · V – vertical rod, Type 2 · M – mortise lock, type 3 · C – concealed vertical rod, type 7, 8 (Specify - WDC for wood door concealed) · TPL – mortise and vertical rod, type 11

\*\*Note: Fire exit devices cannot be dogged down. Some codes permit electric dogging and/or electric latch retraction with fail-secure circuitry.

## Heavy duty touchbar exit devices and crossbar exit devices

### 19 Series

When low cost and dependability are essential, the 19 Series is a great choice. A dependable workhorse, the 19 Series exit device is an economical answer to a variety of exit needs. Available in "B" label (1½ hr.) fire exit construction. Finishes include SP313 powder-coated duranodic, stainless steel and SP28 powder-coated aluminum. The 19 Series comes with a full complement of trims.

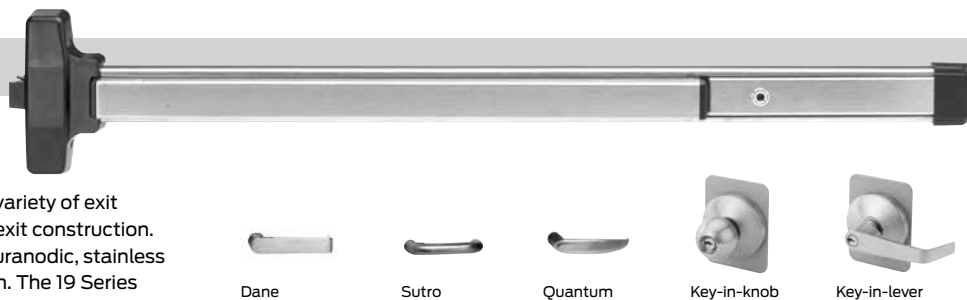

Functions (ANSI)		19-R*	19-V*
EO (01)	Exit only, no trim.	(F)-19-R-EO	(F)-19-V-EO
DT (02)	Entrance by trim when actuating bar is locked down.**	(F)-19-R-DT	(F)-19-V-DT
C or NL (03)	Entrance by trim when latchbolt is retracted by key. Key only removable when locked.**	(F)-19-R-P or C	(F)-19-V-P or C
TP (05)	Entrance by thumbpiece. Key locks or unlocks thumbpiece.	(F)-19-R-TP	(F)-19-V-TP
TP (NL) (06)	Entrance by thumbpiece only when released by key. Key only removable when locked.	(F)-19-R-TP(NL)	(F)-19-V-TP(NL)
L or K (08)	Entrance by knob or lever. Key locks or unlocks knob.	(F)-19-R-L or K	(F)-19-V-L or K
L (NL) or K (NL) (09)	Entrance by knob or lever only when released by key. Key removable only when locked.	(F)-19-R-K(NL) or L(NL)	(F)-19-V-L(NL) or K(NL)

\*R – rim, type 1 • V – vertical rod, type 2

\*\*Note: Fire exit devices cannot be dogged down.

### XX Series

The Falcon XX Series has a classic, traditional design that is dependable as well as attractive. It can inexpensively meet your needs with either panic exit or A label (3 hr.) fire exit constructions. The XX Series is available in brass, bronze and stainless architectural finishes.

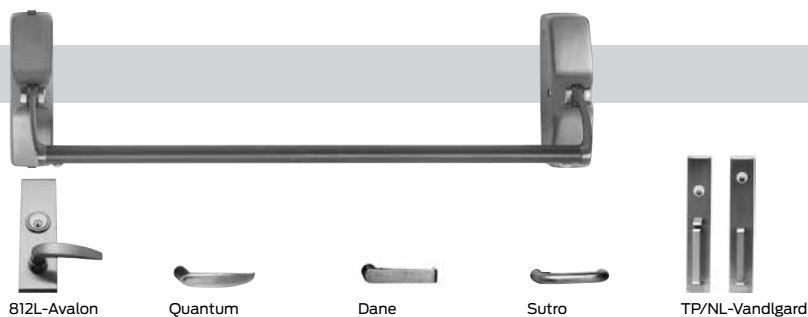

Functions (ANSI)		XX-R**	XX-V**	XX-M**	XX-C**
EO (01)	Exit only, no trim.	(F)-XX-R-EO	(F)-XX-V-EO	(F)-XX-M-EO	(F)-XX-C-EO
DT (02)	Entrance by trim when actuating bar is locked down.**	(F)-XX-R-DT	(F)-XX-V-DT	(F)-XX-M-DT	(F)-XX-C-DT
C or NL (03)	Entrance by trim when latchbolt is retracted by key. Key only removable when locked.**	(F)-XX-R-NL or C	(F)-XX-V-NL or C	(F)-XX-M-NL or C	(F)-XX-C-NL or C
TP (05)	Entrance by thumbpiece. Key locks or unlocks thumbpiece.	(F)-XX-R-TP	(F)-XX-V-TP	(F)-XX-M-TP	(F)-XX-C-TP
TP (NL) (06)	Entrance by thumbpiece only when released by key. Key only removable when locked.	(F)-XX-R-TP(NL)	(F)-XX-V-TP(NL)	(F)-XX-M-TP(NL)	(F)-XX-C-TP(NL)
TP (2) (05)	Entrance by thumbpiece. Inside key locks or unlocks thumbpiece. Outside key retracts latch.	(F)-XX-R-TP(2)	–	(F)-XX-M-TP(2)	–
TP (2 O.C.) (07)	Double outside cylinder. One unlocks thumbpiece, the other cylinder retracts latchbolt.	(F)-XX-R-TP(2 O.C.)	–	–	–
L or K (08)	Entrance by knob or lever. Key locks or unlocks knob.	(F)-XX-R-L or K	(F)-XX-V-L or K	(F)-XX-M-L or K	(F)-XX-C-L or K
L (NL) or K (NL) (09)	Entrance by knob or lever only when released by key. Key removable only when locked.	(F)-XX-R-L(NL) or K(NL)	(F)-XX-V-L(NL) or K(NL)	(F)-XX-M-L(NL) or K(NL)	(F)-XX-C-L(NL) or K(NL)
L (2) or K (2) (10)	Entrance by knob or lever. Inside key locks or unlocks knob. Outside key retracts latch.	(F)-XX-R-L(2) or K(2)	–	(F)-XX-M-L(2) or K(2)	–
L (2 O.C.) or K (2 O.C.) (10)	One cylinder locks or unlocks knob. Other cylinder retracts latch.	(F)-XX-R-L(2 O.C.) or K(2 O.C.)	–	–	–
TLP or TL (11)	Entrance by control turnpiece. Key locks or unlocks control.	–	(F)-XX-V-TL	–	(F)-XX-C-TL or TLP
TLP (NL) or TL (NL) (12)	Entrance by control turnpiece only when released by turning key. Key removable only when locked.	–	(F)-XX-V-TL(NL)	–	(F)-XX-C-TL(NL) or TLP(NL)

\*R – rim, type 1 • V – vertical rod, type 2 • M – mortise lock, type 3 • C – concealed vertical rod, type 7, 8 (Specify - WDC for wood door concealed)

\*\*Note: Fire exit devices cannot be dogged down. Some codes permit electric dogging. Not available on XX.

# FALCON®

## Medium duty touchbar exit devices

### 1690/1790 Series touchbar exit devices

#### The #1 exit device for aluminum doors

Falcon offers the standard in aluminum door exit devices, the 1690 and 1790. The exit devices offer long-lasting performance with a sleek, modern touchbar design. The 1690 and 1790 come in seven popular finishes, four lengths (30", 36", 42" and 48") and feature a full complement of electrical options. Rod extension kits are also available. The 1690/1790 pushbar width is 2 1/2". The devices project 3" in the neutral position, and 2 1/4" in the depressed/dogged position.

#### 1690/1790 features

- Centercase provides a clear indication of direction of egress and completely covers the existing 1990 prep
- Metal end caps protect the device from damage caused by passing carts and equipment
- Available in US28 clear, DC13 dark bronze, DC35 black, US3, US10, US26 and US26D (centercase and endcaps are powder-coated black only)
- Electric latch retraction and request-to-exit/touchbar monitor switch options available
- Electric dogging

#### 1690 Series

The design of the 1690 is ideally suited for demanding, high-traffic applications. The vertical rods and latch mechanisms are concealed in the vertical door stile, ensuring trouble-free operation. The cover plates and end caps are constructed of cast metal to hold up to rigorous use. A quick, single-point dogging feature in the housing deactivates the device and permits unrestricted traffic flow. This locking mechanism is designed to offer more versatility than crossbars, which require two-point dogging. Since 1690 utilizes the same rods and latches as the 1990 crossbar device, existing 1990s can be replaced directly with the 1690 device — without removing the door.

#### 1790 Series

The 1790 rim device is typically used in applications where maintenance is a concern. The rim device has fewer parts and pieces than current exit devices, and requires less maintenance and adjustment. The 1790 may also be used to retrofit a 2090 Series crossbar device.



Model	Trim package	ANSI type	Function
1690	No outside trim	6	01
1691	Pull only (9970)	6	02
1692	Cylinder only	6	03/04
1693	Pull and cylinder	6	02/03/04



Model	Trim package	ANSI type	Function
1790	No outside trim	4	01
1791	Pull only (9970)	4	02
1792	Cylinder only	4	03/04* or 08/09*
1794	Pull (9970) and cylinder	4	02/03/04

\*Requires use of 179L

## Medium duty touchbar exit devices and concealed vertical rod devices

### 1590 Series touchbar devices



The EL1590 electrified exit device provides convenience and security in a surface-applied exit device ideal for any type of door. A monitor switch is included.

Note: The EL1590 and ED1590 Series are handed devices.

#### Clean looks in a rim pushpad device.

The 1590 offers the aesthetic benefit of the 1490 with the installation and maintenance ease of a rim exit device.

- Quarter-turn dogging
- Simplified cartridge mounting for most standard rim cylinders
- Durable metal end caps
- Available in a full range of architectural finishes

Model	Trim package	ANSI type	Function
1590	No outside trim	4	1
1591	Pull only (9970)	4	2
1592	N.L. cylinder	4	3
1593	H.B. cylinder	4	4
1594	Pull w/N.L. cylinder	4	02/03
1595	Pull w/H.B. cylinder	4	02/04

### 1490 Series concealed vertical rod touchbar devices



The 1490 device is built with rugged steel operating mechanisms, and durable aluminum push bars and end caps. The electrified version includes a monitor switch.

Note: The EL1490 and ED1490 Series are handed devices.

#### The original pushpad device.

The 1490 is our heaviest device and offers a clean appearance with pushpad styling and a variety of practical features.

- Height is 3- with 2<sup>3</sup>/<sub>4</sub>" projection
- Quarter-turn dogging
- Simplified cartridge mounting for most standard rim cylinders
- Available in a full range of architectural finishes
- Durable metal end caps
- Rod extension kits for doors 7' to 10' available

Model	Trim package	ANSI type	Function
1490	No outside trim	6	1
1491	Pull only (9970)	6	2
1492	N.L. cylinder	6	3
1493	H.B. cylinder	6	4
1494	Pull w/N.L. cylinder	6	02/03
1495	Pull w/H.B. cylinder	6	02/04
1498	Dummy	6	

# FALCON®

## Vertical rod and crossbar exit devices

### 2390 Series recessed concealed vertical rod devices

The best available recessed concealed device for stile and rail doors

The 2390 is a Grade 1 exit device designed for high use and abuse, and delivers a variety of performance features that ensure smooth, easy and reliable operation. Easier rod adjustment simplifies installation.

- Sloped metal end caps
- Sound dampening on the in-stroke and out-stroke
- Night latch/hold back feature
- Electric latch retraction available
- Request-to-exit switch (touchbar monitor) available
- Field-reversible handing



Model	Trim package	ANSI type	Function
2390	No outside trim	6	01
2392	Mortise cylinder assembly with cylinder	6	03
2395	Mortise cylinder assembly with less cylinder	6	03/04
2398	Dummy	6	

### 1990 Series rim concealed vertical rod devices

The industry standard for aluminum door exit devices

Classic looks and a long history of reliable performance has made the 1990 the number 1 selling exit device for aluminum doors. This ANSI Grade 1 device features hardened steel latches and is compatible with stiles as narrow as 1<sup>3</sup>/<sub>4</sub>".

The 1990 device is equipped with hardened steel latches and an adjustable strike to ensure safety, security and quiet operation.

**Other features include:**

- Concealed mounting screws
- Field adjustable width
- Available in a full range of painted and architectural finishes
- Hex dogging
- UL Listed 305
- Field reversible (non-handed)



Model	Trim package	ANSI type	Function
1990	No outside trim	6	01
1991	Pull only (9970)	6	02
1992	Cylinder only	6	03/04
1993	Pull and cylinder	6	02/03/04

### 2090 Series rim crossbar devices

Classic looks in a rim exit device.

The 2090's balanced appearance, dependable performance, and economical pricing has made it a popular choice where rim exit devices are required. Equipped with a 1/2" throw steel latchbolt, the 2090 can be mounted on stiles as narrow as 1<sup>3</sup>/<sub>4</sub>". Removable mullions are available for pairs of doors applications.

The 2090 is an ANSI Grade 1 device.

**Other features include:**

- Surface mounted strikes for full frame or blade type stops
- Field adjustable width
- UL Listed 305
- Available in a full range of painted and architectural finishes



Model	Trim package	ANSI type	Function
2090	No outside trim	4	01
2091	Pull only (9970)	4	02
2092	Cylinder only	4	03/04
2093	Pull and cylinder	4	02/03/04

# Accessories

## Mullions

### RM 70/170 removable mullion.

The RM 70 is designed for use with 2090 Series and the RM170 for use with 1790 Series. Each comes complete with adjustable mortised strikes and security clips. Compatible with doors 7' to 10' and for use on doors with stiles as narrow as 1<sup>3</sup>/<sub>4</sub>". Made of aluminum and available in anodized aluminum or bronze finishes.

### RM 150 removable mullion.

For use with 1500 Series only. Comes complete with adjustable mortised strikes and security clips. Compatible with doors 7' to 10', and for use on doors with stiles as narrow as 1<sup>3</sup>/<sub>4</sub>". Made of aluminum and available in anodized aluminum or bronze finishes.

## Strikes

<b>SD 35</b>	Standard strike for <b>2090</b> device
<b>SD 36</b>	Strike for <b>2090</b> device (for all stops)
<b>PB 48</b>	Standard top strike for <b>1490/1690/1990/2390</b>
<b>STK 45</b>	Stainless steel strike for inactive leaf, pair of doors for 1590/1790/2090
<b>TD 35</b>	Strike for <b>1590/1790</b> rim device

## Pulls

<b>9970 pull</b>	Standard pull for <b>1490/1590/1990/2090</b>
------------------	--

# FALCON®

## Closers

### Making aluminum closers easy

The Surface Closer (SC) Series is designed to meet the most common installation and application requirements in the commercial marketplace and, in most cases, provide an identical footprint which makes renovation and retrofit work very easy. All SC Series closers are covered by a 10-year warranty and shipped with throughbolts, wood and machine screws. Closers without hold-open arms have been certified by UL and cUL to be in compliance with UL10C for use on fire-rated doors. Closers are available in painted aluminum, dark bronze, brass and matte black\* finishes.

### SC70 Series

- Heavy-duty cast aluminum door closer
- Ready-to-mount hinge side, top jamb, or parallel arm configuration
- **Arm options:** regular (RW/PA), hold-open (HW/PA), heavy-duty (HD/PA), dead stop (DS), dead stop hold-open (DS/HO), spring 'n' stop (SS), spring 'n' stop hold-open (SS/HO), forged arm (FA) and forged arm hold-open (FA/HO)
- Adjustable size 1-6
- 1½" diameter piston
- SC70 closers are suitable for interior doors up to 54" (1371mm) wide and exterior doors up to 48" (1219mm) wide, and can be adjusted to meet the ADA accessibility requirements
- Delay action (optional) provides additional time for people to move through the door
- Meets ANSI standard 156.4, Grade 1



### SC80 Series

- Medium-duty cast aluminum door closer
- Ready-to-mount hinge side, top jamb or parallel arm configurations
- **Arm options:** Arm options: regular (RW/PA), hold-open (HW/PA), heavy-duty (HD/PA), dead stop (DS), dead stop hold-open (DS/HO), spring 'n' stop (SS) and spring 'n' stop hold-open (SS/HO)
- Adjustable size 1-6
- Available with full and slim line covers
- SC80 closers are suitable for interior doors up to 54" (1371 mm) wide, and exterior doors up to 42" (1067mm) wide
- SC81 closers are suitable for interior doors up to 48" (1219mm) wide, exterior doors up to 36" wide (914mm) and can be adjusted to meet the ADA accessibility requirements
- Delay action (optional) provides additional time for people to move through the door
- Meets ANSI standard A156.4, Grade 1

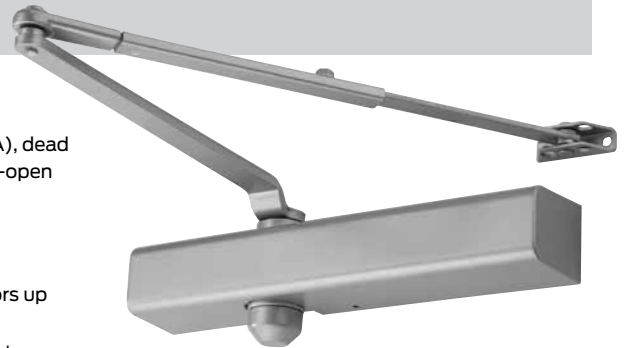

### SC60 Series

- Light/medium-duty cast aluminum door closer
- Ready-to-mount hinge side, top jamb or parallel arm configuration
- **Arm options:** regular (RW/PA), hold-open (HW/PA), heavy-duty (HD/PA), dead stop (DS), dead stop hold-open (DS/HO), spring 'n' stop (SS) and spring 'n' stop hold-open (SS/HO)
- Adjustable size 1-5 (SC60)\*
- Optional slim line cover available
- Delay action (optional) provides additional time for people to move through the door
- Meets ANSI standard A156.4, Grade 1



\* SC60 closers are suitable for interior doors up to 54" (1371 mm) wide and exterior doors up to 52" (1067 mm) wide.

\* Available in late 2016



## Closers

### SC90 Series

- Light-duty cast aluminum door closer
- Ready-to-mount hinge side, top jamb, or parallel arm configuration
- Arm options: regular, hold-open (HO)
- Fixed size 1 (SC91), 3 (SC93) and 4 (SC94)
- SC91 closers are suitable for lightweight interior doors and are preset to meet ADA accessibility requirements
- SC94 closers are suitable for interior doors from 36" (914mm) to 48" (1219mm) wide and exterior doors to 36" (914mm) wide
- SC93 and SC94 available with optional/standard cover
- Meets ANSI standard A156.4, Grade 3



### Overhead concealed door closer

The overhead concealed door closer is designed to meet the common installation and application requirements in the commercial marketplace. The OHC100 Series closer is covered by a five-year warranty. Closers without hold-open function have been certified by UL and cUL to be in compliance with UL 10C for use on fire-rated doors.



#### OHC100 Series

- Easily fits into headers as small as 1<sup>3</sup>/<sub>4</sub>" x 4"
- Arm options: "S" style side load arm, "A" style end load arm and "VO" style offset arm and track (aluminum or dark bronze finish)
- Adjustable size 2-4, fixed size 3
- Positive centering to hold door closed against wind or draft
- Cylinders available in 90 degree and 105 degree non-hold-open and hold-open

#### Finishes



689  
Aluminum



695  
Dark bronze



696  
Brass



622  
Matte black\*

\*Available in late 2016

# FALCON®

## 8200 Automatic operator

Slimmer, sleeker, tougher and makes any opening easier to use.

The 8200 ElectroMechanical low energy operator by Falcon is the most cost-effective solution to automating your entrances. Designed specifically for the commercial market, the Falcon operator is ideal for assisted living communities, low traffic store front entrances, or automating interior doors for added assistance. When used manually, this operator acts like a regular manual door closer.



### Features and benefits

- Integrated intelligent power boost graduates additional closing assist when door nears latch. Helps to ensure secure closing to overcome external conditions and pressure differentials.
- Push 'n' go can be programmed on/off to add automatic operation with slight manual opening of the door.
- Control box detects obstructions in path of door, and will temporarily reprogram opening degree in order to avoid abuse to the door.
- 90° power strain reduction on hinges, operator and other door hardware
- Non handed for right- or left- swinging doors.
- Auto reverse on opening cycle provides safety by reversing direction when coming into contact with a person or object.
- Microprocessor control box for reliability.
- Standard 26" length header with aluminum finish.
- Certified to meet UL and ANSI A156.19 requirements.

### Available accessories

The Falcon operator comes with an easy to select and install line of accessories, to help meet most operator applications.

- 4 3/4" square stainless steel plate
- Flush mount or surface mount box
- Weather ring
- Wireless transmitter
- Wireless receiver

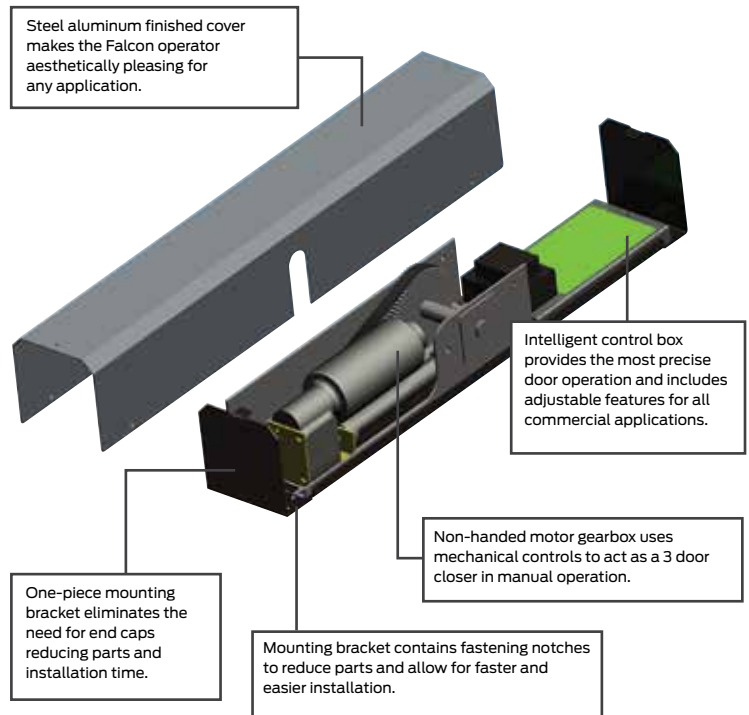



Sealing systems  
for doors and windows

## Contents

Thresholds and ramps  
Traction tread™  
Sill protection  
Head and jamb protection  
Meeting stiles  
Flood barrier shield for doors  
Sound trap  
Hinges

Zero's commitment to the highest standards throughout our more than 85-year history has made our name synonymous with quality and performance in our industry. In projects where those standards are important, specifications for door and window gasketing stipulate "Zero, no substitutes." We are also recognized for providing expert technical support for both the specification and application of all our products.

For complete product catalog, price list & specification guide, please call 1-800-635-5335.

Zero's catalog and drawings are also available on our website at: [www.zerointernational.com](http://www.zerointernational.com)



# Adjustable, rabbeted, utility, and interlocking thresholds and ramps

Thresholds and ramps for every type of installation. Utility, thermal break, interlocking, butt and carpet divider. Available in aluminum or bronze, our in-stock selection is second to none.

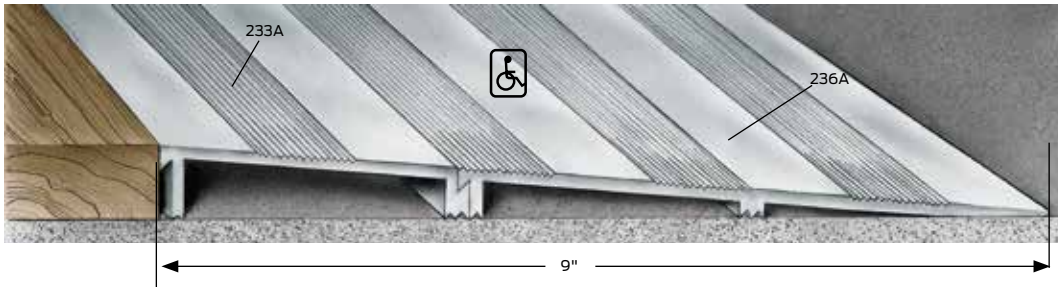
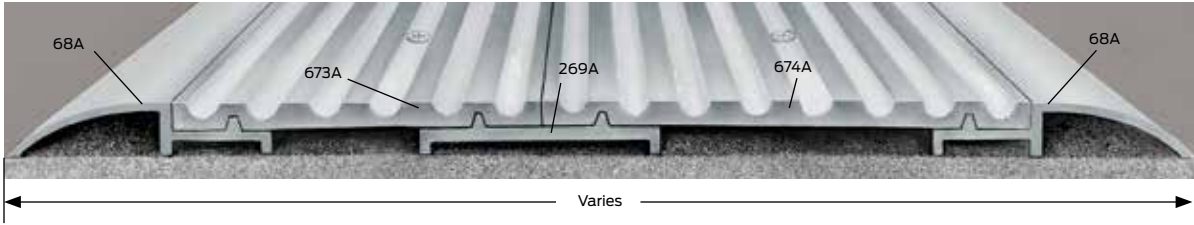

## Series 671

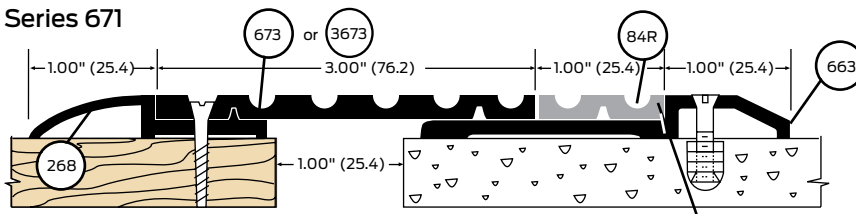

Floor covers for 1" expansion joints

Traction Tread Rubber

## Utility thresholds

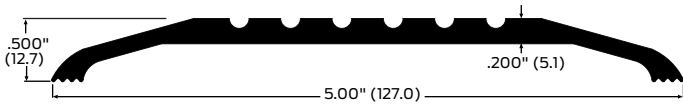

- |       |                |             |                         |
|-------|----------------|-------------|-------------------------|
| #655A | 653A Aluminum  |             | 3" wide x 1/2" high     |
|       | 654A Aluminum  | 654B Bronze | 4" wide x 1/2" high     |
| #655B | 655A Aluminum  | 655B Bronze | 5" wide x 1/2" high     |
|       | 656A Aluminum  | 656B Bronze | 6" wide x 1/2" high     |
|       | 657A Aluminum  | 657B Bronze | 7" wide x 1/2" high     |
|       | 6575A Aluminum |             | 7-1/2" wide x 1/2" high |

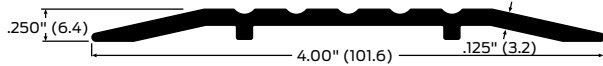

- |       |               |             |                         |
|-------|---------------|-------------|-------------------------|
| #544A | 64A Aluminum  |             | 2-1/2" wide x 1/4" high |
|       | 63A Aluminum  |             | 3" wide x 1/4" high     |
|       | 544A Aluminum |             | 4" wide x 1/4" high     |
|       | 545A Aluminum | 545B Bronze | 5" wide x 1/4" high     |
|       | 546A Aluminum |             | 6" wide x 1/4" high     |
|       | 547A Aluminum |             | 7" wide x 1/4" high     |
|       | 548A Aluminum |             | 8" wide x 1/4" high     |

## Interlocking thresholds

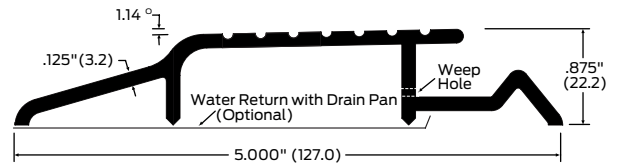

### #175A #175B

In opening  
For use with doors 1 3/4" or greater.  
PAN-Z available in 3' lengths only, comes with weep hole option.

### Rabbeted thresholds

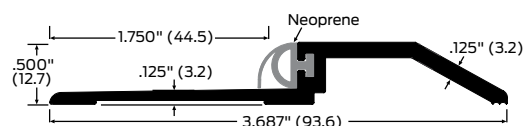

#564A #564B #564D

### Thermal break thresholds

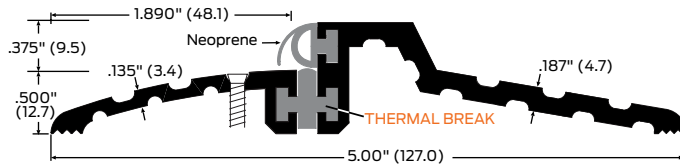

#525A #526A  
(6.00" not illustrated)

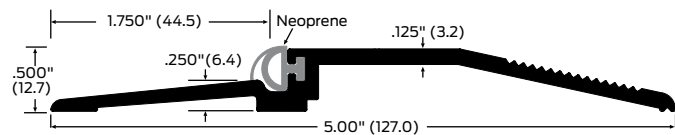

#566A #566B

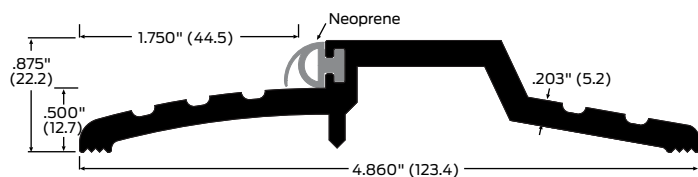

#565A #565B

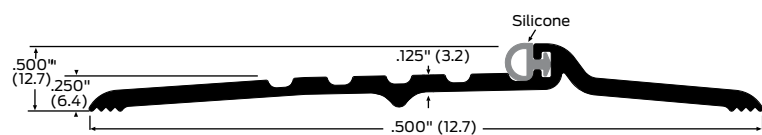

#65A #65B

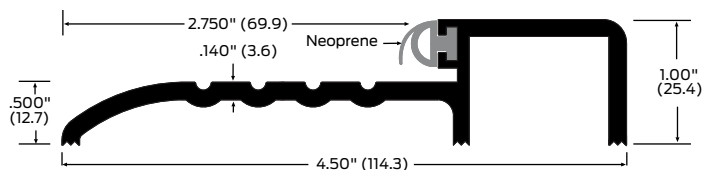

#561A

Note:  
 A = Aluminum  
 B = Bronze  
 D = Dark Bronze Anodized



## Traction tread™ thresholds and nosing – ADA

Traction tread provides a detectable warning for stairs and ramps.

Traction tread thresholds and nosings are available with a special epoxy abrasive (non-slip particles) bonded into the grooves or with our exclusive formulated rubber inserts.

### Rubber traction tread

The ultimate safety surface. Smooth, tough rubber inserts that are flush with and wear at the same rate as the aluminum surface. The aluminum/rubber combination is easy to cut and drill at the jobsite. Superior non-slip traction with great longevity.

### Abrasive traction tread

An attractive, extremely durable surface that provides a high degree of safety. The epoxy abrasive particle mix is bonded to the aluminum base and is perfect for schools, hospitals, industrial buildings.

All items shown below can be ordered with rubber abrasive or glow abrasive inserts. For traction tread rubber use numbers below. For traction tread epoxy abrasive add -E after the item number. Example: 3673A-E or 3673B-E. For glow traction tread add -L after the item number. Example: 3672 A-E-L.

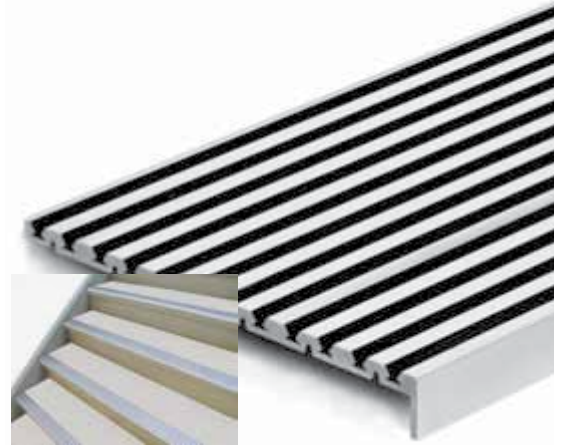

Traction tread rubber or epoxy abrasive tread or glow traction tread

Note:  
 A = Aluminum  
 E = Epoxy  
 B = Bronze  
 L = Photoluminescent (Glow)

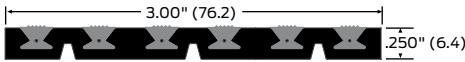

Available Tread Sizes			Epoxy Abrasives	Photo-luminescent
3672A	Aluminum	2" wide	3672A-E	3672A-E-L
3673A	Aluminum	3" wide	3673A-E	3673A-E-L
3674A	Aluminum	4" wide	3674A-E	3674A-E-L
3675A	Aluminum	5" wide	3675A-E	3675B-E-L
3676A	Aluminum	6" wide	3676A-E	3676A-E-L

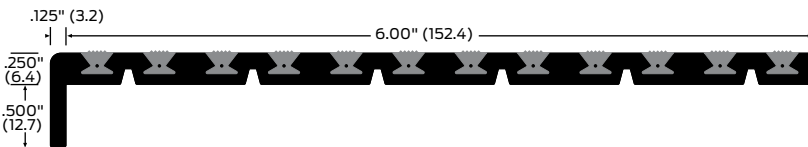

Nosing Sizes				Photo-luminescent
2673A	Aluminum	3" wide with traction tread rubber		–
2673B	Bronze	3" wide with traction tread rubber		–
2676A	Aluminum	6" wide with traction tread rubber		–
2673A-E	Aluminum	3" wide with epoxy abrasive tread		2673A-E-L
2673B-E	Bronze	3" wide with epoxy abrasive tread		2673B-E-L
2676A-E	Aluminum	6" wide with epoxy abrasive tread		2676A-E-L

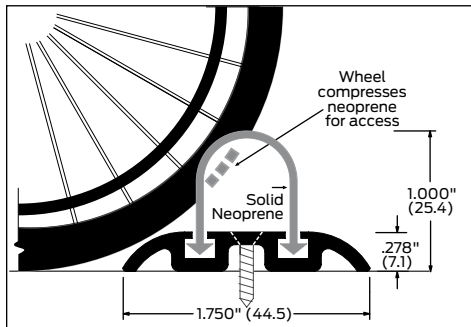

### Wheel chair accessible shower threshold

Designed for use when a shower must be accessible to a wheel chair. The Neoprene gasket will keep water in while allowing the wheel chair to pass over easily



### Threshold assemblies

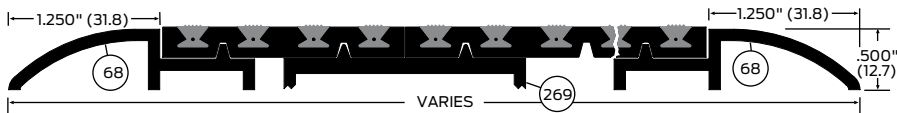
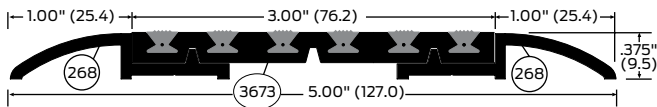
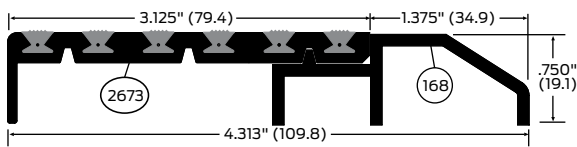

### Bulkhead door adjustable thresholds

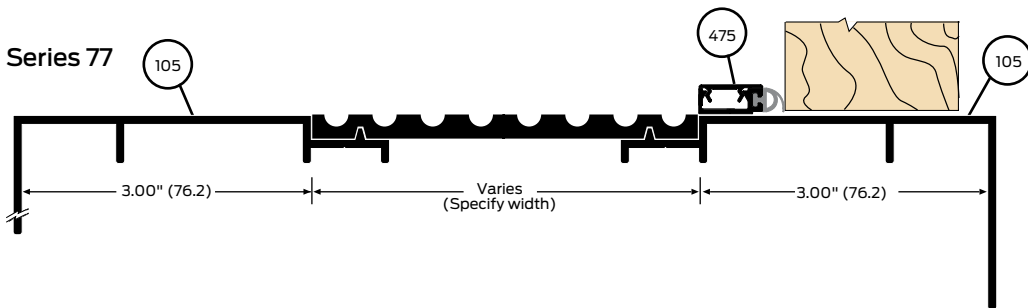

Adjustable thresholds can be installed using aluminum plates, or Traction Tread plates.



## Sill protection – automatic door bottoms

### High sound, automatic door bottom

Zero International has engineered its full line of Automatic Door Bottoms for optimal ease of installation and durability as well as superior performance, even under challenging conditions. These units are designed with specialized features to ensure an effective seal at the bottom of the door against air and smoke filtration, or penetration by sound, light. Zero Automatic Door Bottom models utilize a concealed spring mechanism which activates when the door is closed to drop a neoprene seal insert firmly against the door or saddle. Triggered by a hinge-side “plunger” that is compressed by the frame as the door closes, the spring bends downward, dropping the seal in a scissor-like motion from the hinge side and adjusting to the door from a center pivoting point. This ensures a smooth drop without drag and a tight seal, even on an uneven door. U.S. Patent #4947584.

#### #367AA

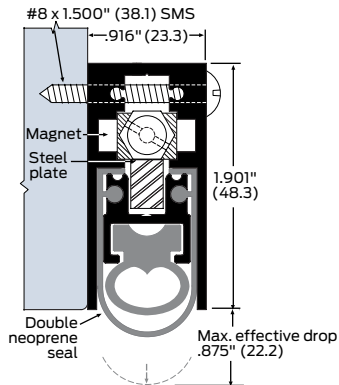

Adjusting brass cylinder nut with optional plastic cushion

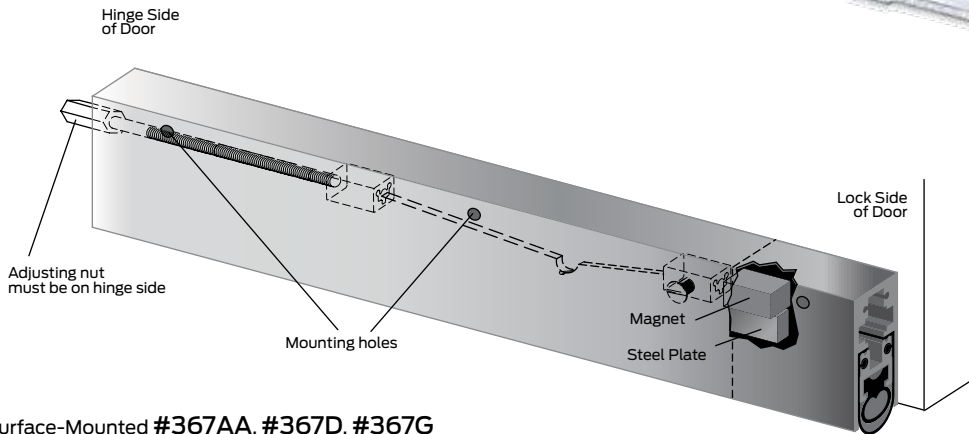

Surface-Mounted **#367AA, #367D, #367G**  
Semi-Mortised **#368AA, #368D, #368G**  
Mortised **#369AA**

Can also be used with #Z950 Cam Lift Hinges



Heavy duty automatic door bottoms

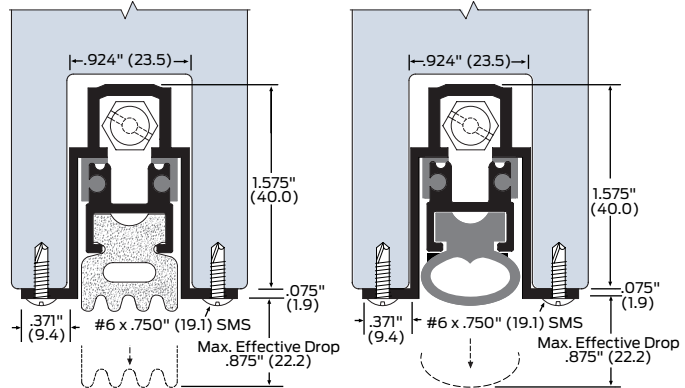

Mortised  
#360AA

Mortised  
#364AA

Regular duty automatic door bottoms

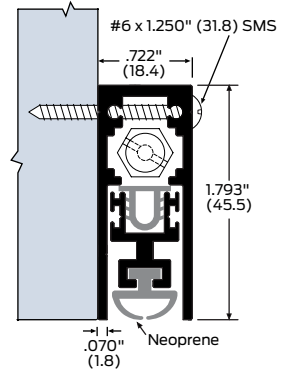

Surface-Mounted Semi-Mortised  
#351AA #352AA  
#351D #352D

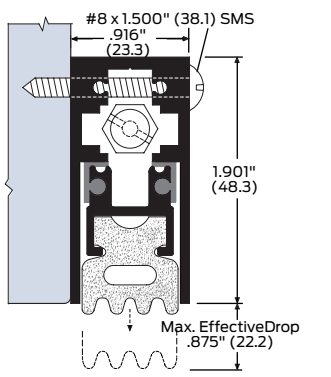

Surface-Mounted Semi-Mortised  
#361AA #362AA  
#361D #362D  
#361G #362G

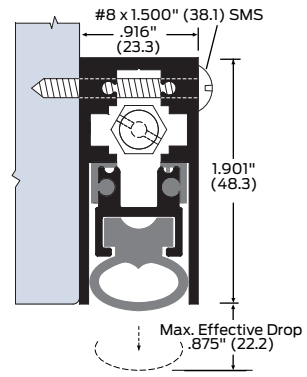

Surface-Mounted Semi-Mortised  
#365AA #366AA  
#365D #366D  
#365G #366G

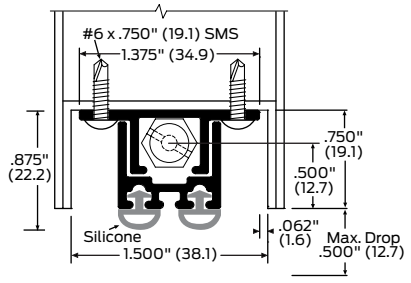

Mortised  
#355A

Note:  
A = Aluminum  
AA = Clear Anodized  
D = Dark Bronze Anodized  
G = Gold Anodized

Door sweeps

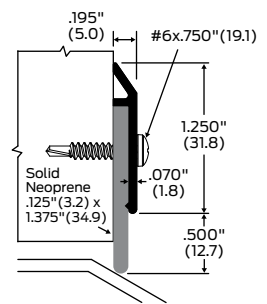

#39A  
#39D

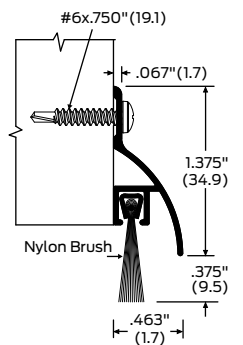

#8198AA #8198G  
#8198D

# Head and jamb protection

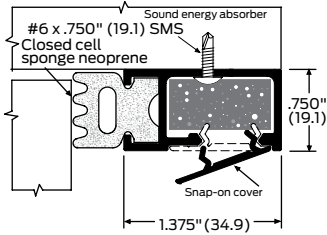

#470AA #470D

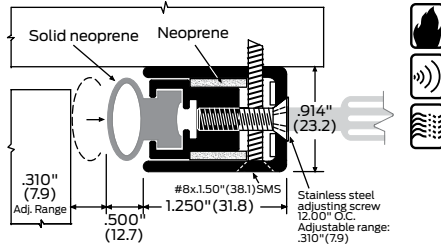

#770AA #770D  
45 min. as a stop on case opened steel frame  
90 min. when applied to stop on certified steel frame

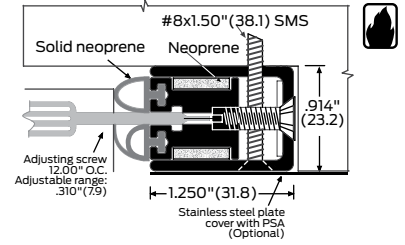

#7770AA #7770D #7770G

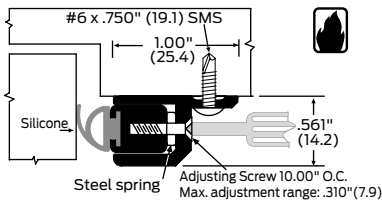

#712AA #712D

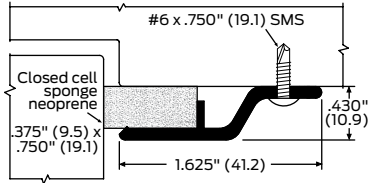

#140AA

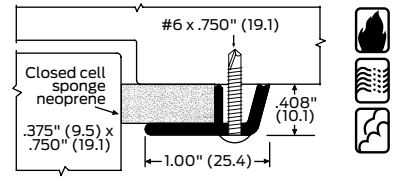

#318AA #318D

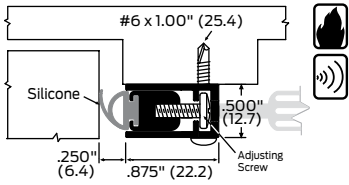

#870AA #870D

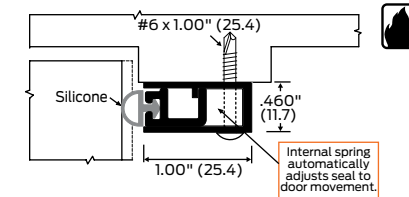

#570AA

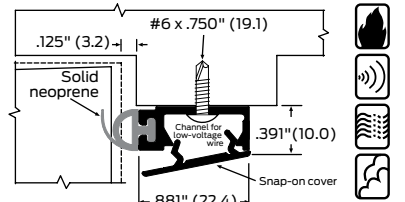

#475AA #475D #475G

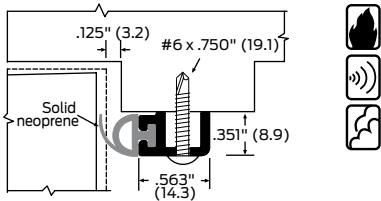

#485A #485D #485G

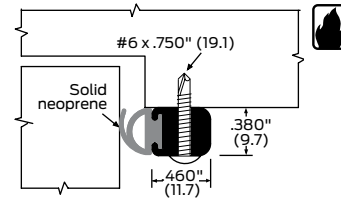

#31AA #31D #31G

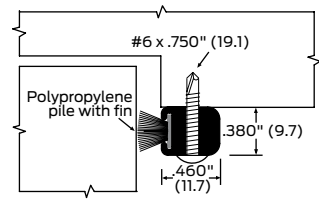

#32AA #32D #32G

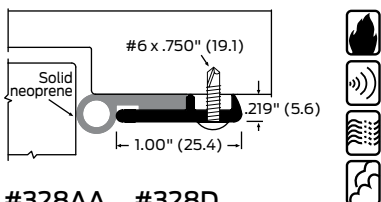

#328AA #328B #328D #328G

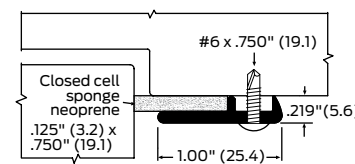

#314AA #314B #314D #314G

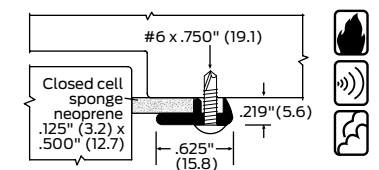

#312AA

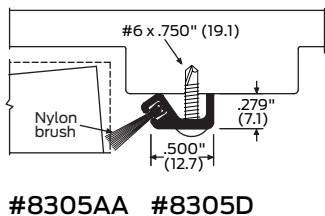
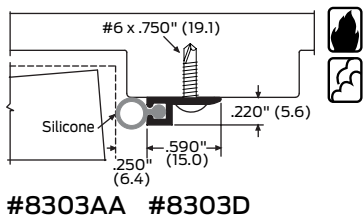
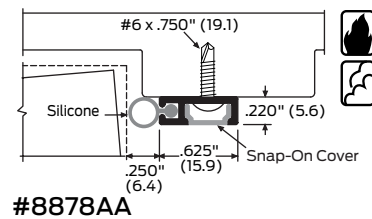
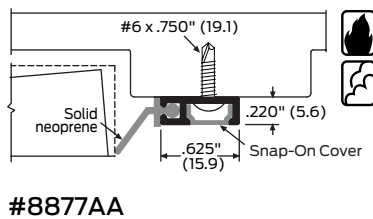
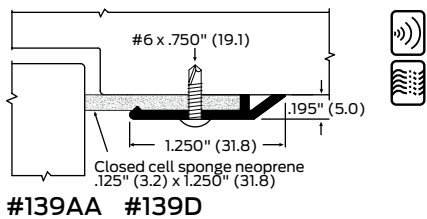

Note:  
 A = Aluminum  
 AA = Clear Anodized  
 B = Bronze  
 D = Dark Bronze Anodized  
 G = Gold Anodized

**Self-adhesive (PSA) door seals—head and jamb**

Note: S = Silicone, available colors: Bk (black), Br (brown), Cl (clear), Gy (grey), Wh (white)  
 N = Neoprene FS = Intumescent BIO = Antibacterial rubber

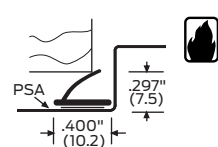
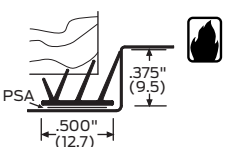
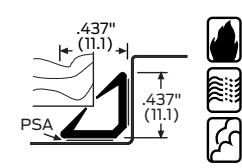
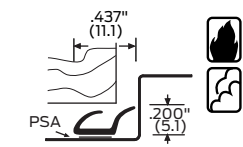
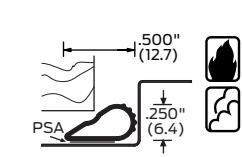
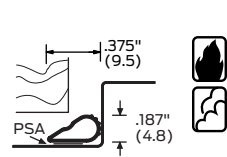
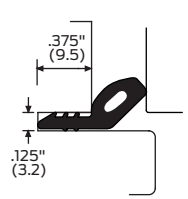
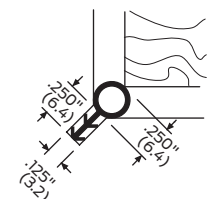
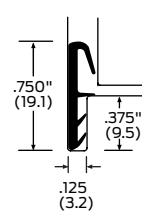
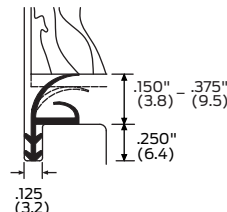
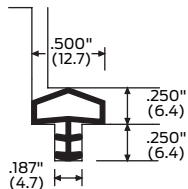
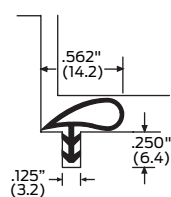

# Meeting stiles

## Mortised

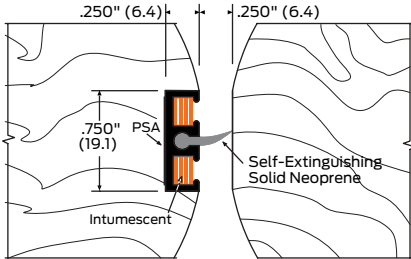

**#59FS A** with neoprene blade   
**#159FS A** without neoprene blade, clearance .125"

## Adjustable mortised astragal

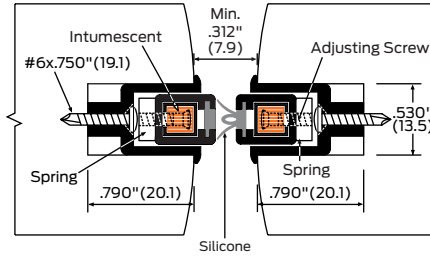

**#56FS AA** **#557FS AA**  
**#56FS G** **#557FS G**  
**#56FS D** **#557FS D**  
 Neoprene insert Silicone insert

## Adjustable mortised astragal

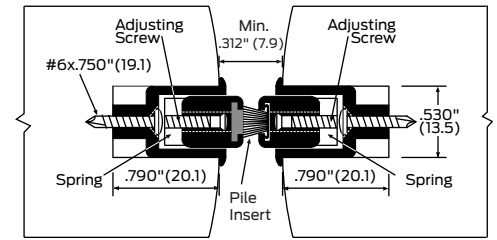

**#56AA** **#156AA**  
**#56D** **#156D**  
**#56G** **#156G**  
 Neoprene insert Pile insert

## Adjustable mortised astragal

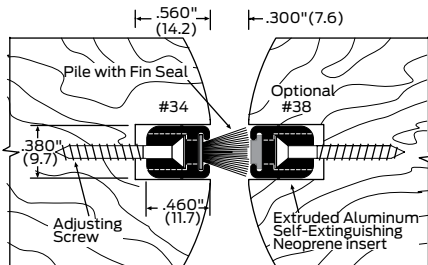

#38 is used when clearance of the door is too large, or to make the doors look the same

**#34AA** **#38AA**  
**#34D** **#38D**  
**#34G** **#38G**  
 Pile with fin seal Solid neoprene insert

## #40 interior magnetic astragal

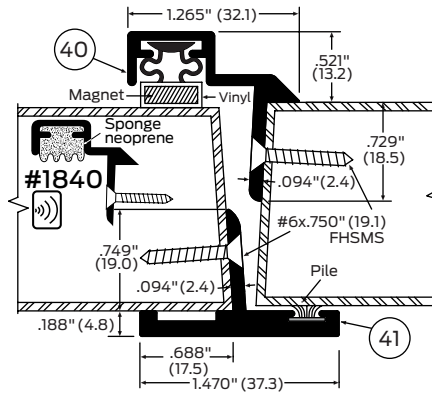

**#41 exterior magnetic astragal**  
**#41AA**  
**#41D**

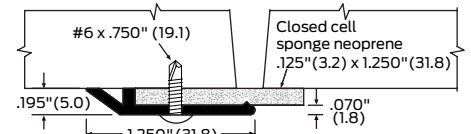

**#139A** **#139D**

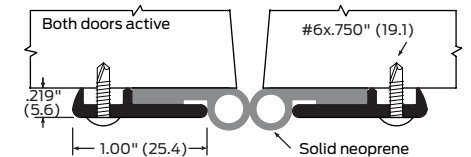

**#328AA** **#328D**  
**#328B** **#328G**

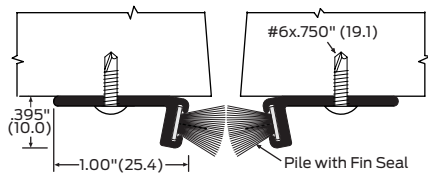

**#98A** **#98D**

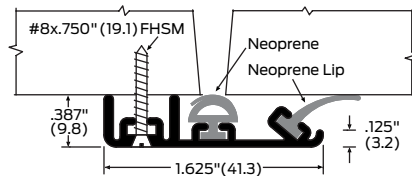

**#383AA** **#383D**

## Adjustable surface astragal

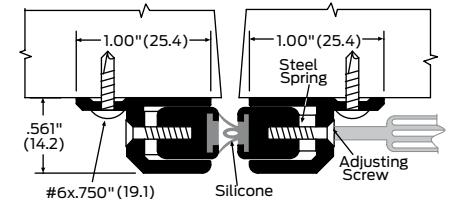

**#55AA** **#555AA**   
**#55D** Solid neoprene insert **#555D** Silicone insert

Note:  
 A = Aluminum  
 AA = Clear Anodized  
 B = Bronze  
 D = Dark Bronze Anodized  
 G = Gold Anodized

## Flood barrier shields for doors

This removable barrier that answers pleas from residential builders for help in protecting doors -household contents - form water ingress in flood-prone areas. When water from heavy rains accumulates, Zero's Flood Barrier Shields effectively block up to a foot or more flood waters from permeating door openings. Available in 10, 20, 24, 30, 36 inch high barriers (other size available upon request), the lightweight aluminum shield requires no tools or muscle strength for insertion into pre-mounted vertical channels attached to either the door frame or adjacent walls. The key to the shield's impermeability is the use of closed cell sponge (CCS) neoprene rubber engineered by Zero to ensure a water-tight seal. The rubber lines the aluminum channel brackets and the bottom of each shield section. The neoprene also compensates for gaps at the threshold.

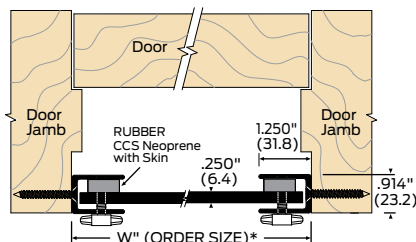

### Inside mount installation

- #2070A - 10 10" High
- #2070A - 20 20" High
- #2070A - 24 24" High
- #2070A - 30 30" High
- #2070A - 36 36" High

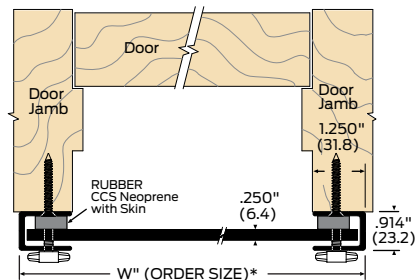

### Outside mount installation

- #2071A - 10 10" High
- #2071A - 20 20" High
- #2071A - 24 24" High
- #2071A - 30 30" High
- #2071A - 36 36" High

Each Flood Barrier Shield is custom fabricated.

Specify exact width needed.

\* Aluminum panel insert is supplied 7/16" shorter than order size.

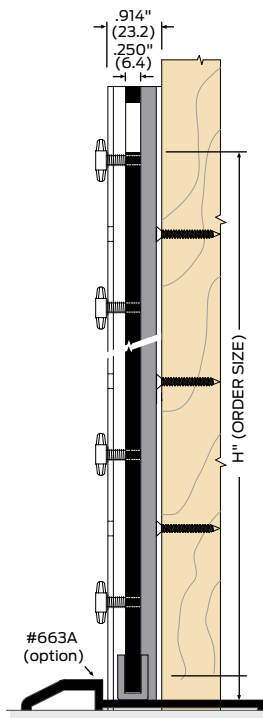

### Outside mount





## Sound trap Sound control systems

When most doors are tested for sound rating, the door and frame are installed and caulked shut. When Zero sound control systems are tested, the opening is rated with the door operable. Zero installs a door, frame, hinges, locks and gasketing. The door is opened and closed a number of times, per ASTM E-90 standards. The test results (using all 18 one-octave bands) represent the actual Sound Transmission Class (STC) value of the opening. To specify our sound control systems, installation instructions, product thickness, type of material (aluminum or bronze), type of rubber (neoprene, closed cell sponge or solid), are critical. Substitutions or deletions will void STC ratings. The overall sound transmission (STC) reduction will only be as good as the weakest part of the system.

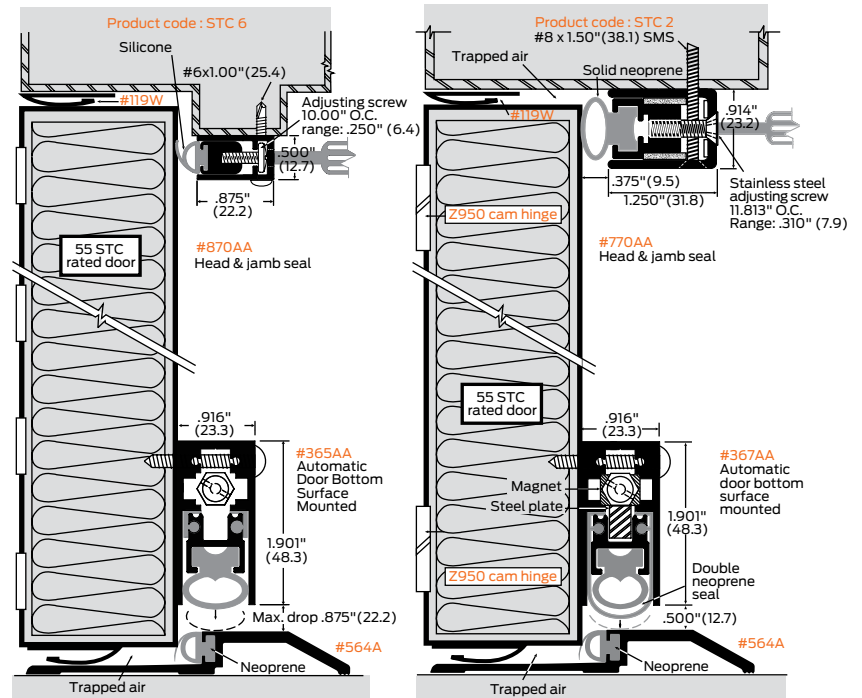

### Sound trap systems—high level rating

Gasketing system	Head & jamb	Threshold	Auto. door bottom	STC rating
STC 1	3708 & 119WB	564B	367	53 STC
STC 2	770 & 119WB	564B	367	52 STC
STC 3	770 & 119WB	656B	367	51 STC
STC 4	170 & 119WB	564B	367	51 STC
STC 5	485 & 119WB	565A	361	49 STC

Sound Transmission Class (STC)—The ability to prevent the transfer of sound from one area to another.

### “Safe haven” room gasketing air infiltration

100 MPH (165KM/H) wind velocity air leakage 0.50 CFM (2.8CMH)

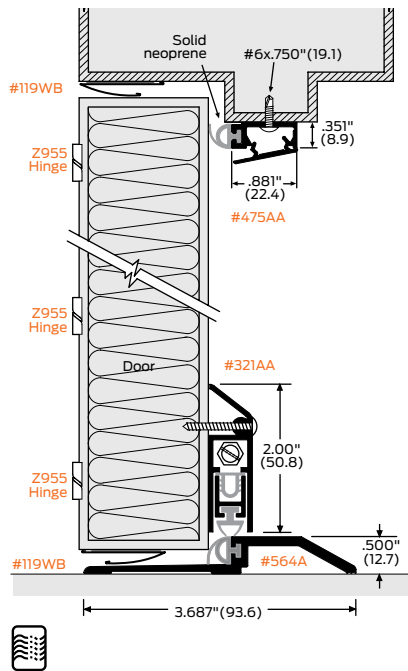

### Hotel interior entry doors

53 STC Rating

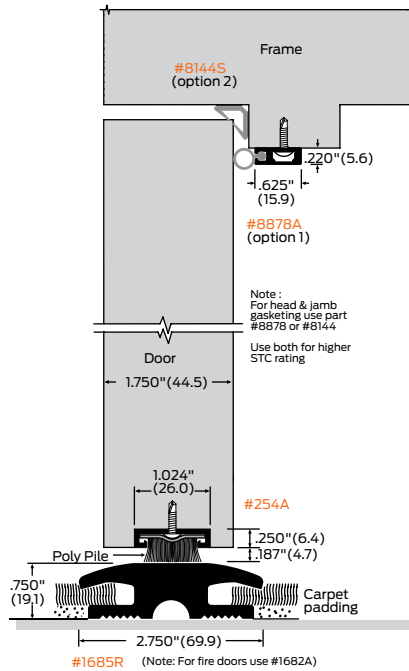

### Latching pocket doors

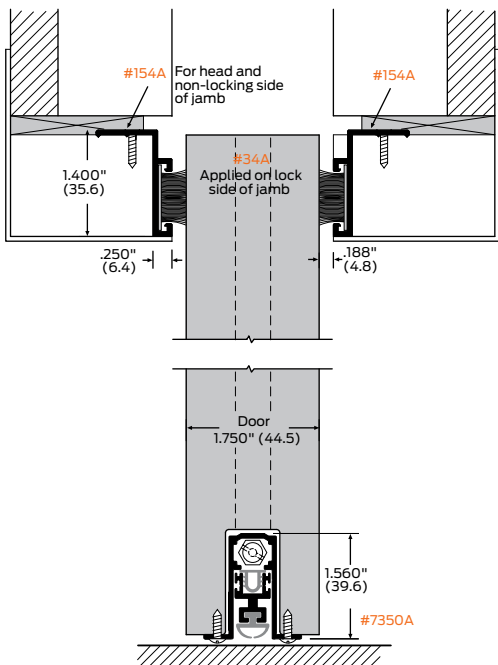



# Hinges

## Cam Lift mortise hinges

Mortise-Type Cam Hinge for use with EMI/RFI and sound-insulating doors utilizing acoustical seals. The cam action greatly improves the sealing characteristics along the door perimeter, lifting and lowering the door with the swing. Designed for doors weighing up to 500 lbs. Available for right or left-hand swinging doors. Cam lift hinges will not bind door closed when doors are hung within accepted industry standards. Tested with LCN 4041 Series original. Finish: 630 (US32D).



**Cam Lift stainless steel, handed**  
5"(127.0) x 5"(127.0) x .250"(6.4)  
**#Z950**



**Cam Lift stainless steel, handed**  
5"(127.0) x 4.5"(114.3) x .180"(4.6)  
**#Z953**



**Cam Lift stainless steel, handed**  
4.5"(114.3) x 4.5"(114.3) x .134"(3.4)  
**#Z955**

---

## Lites & louvers



**Vision lites**   
**#T4G**

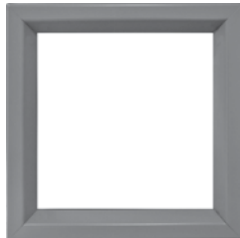

**Vision lites**   
**#784G**



**Free flow door louvers**  
**#8CY**



**Free flow door louvers**   
**#200AIL** 90 min.

Other models available. For more information visit us at [www.a-ll.com](http://www.a-ll.com)



Your source  
for hardware  
specifications

Complete Hardware  
Specifications and  
Door Schedules

AIA Registered  
Continuing Education

Hardware Submittals and  
Requests for Approval

Consulting on  
Accessibility, Fire and Life  
Safety Codes

© 2014 Allegion

At Allegion, we want to partner with you.

With over 100 hardware consultants located across the nation, we offer a wide range of experience with electronic and mechanical hardware, as well as doors and frames. We offer local one-on-one specification consulting services for finish hardware, electronic hardware, handicap operators and hollow metal. Additionally, we help ensure that your project runs smoothly around the door openings, and has proper installation and operation of doors and door hardware through pre-installation instruction and post-installation inspections.

Learn more at: [allegion.com/us](http://allegion.com/us) or call 888-337-6715

aptiQ ■ LCN ■ SCHLAGE ■ STEELCRAFT ■ VON DUPRIN



**ALLEGION**<sup>™</sup>

PIONEERING SAFETY<sup>™</sup>

## About Allegion

Allegion (NYSE: ALLE) is a global pioneer in safety and security, with leading brands like CISA®, Interflex®, LCN®, Schlage® and Von Duprin®. Focusing on security around the door and adjacent areas, Allegion produces a range of solutions for homes, businesses, schools and other institutions. Allegion is a \$2 billion company, with products sold in almost 130 countries. For more, visit [www.allegion.com](http://www.allegion.com).

*aptiQ* ■ LCN ■ **SCHLAGE** ■ STEELCRAFT ■ VON DUPRIN