



MAKING HARD WORK EASIER
PRODUCT CATALOG 2016

SENCO®



Since 1948, SENCO has been synonymous with professional results, quality, increased productivity and craftsmanship.

Customers around the world have put SENCO's innovative products to work in a variety of demanding applications, counting on them to perform every day. Today, SENCO continues to pioneer new technologies in all areas of professional fastening solutions.

At SENCO, our mission is to be the undisputed provider of choice for quality fastening solutions that increase productivity and make work safer and easier to perform.

We value input from our users and focus on responsive innovations that make fastening simpler and more efficient

We design and engineer every SENCO fastening system to deliver outstanding results and maximize productivity.

We have a focus on safety because we want everyone who uses our products to have a long and injury free career.

At SENCO, we are dedicated to bringing you only the best in professional fastening systems. We promise to be a true partner in creating fastening solutions.

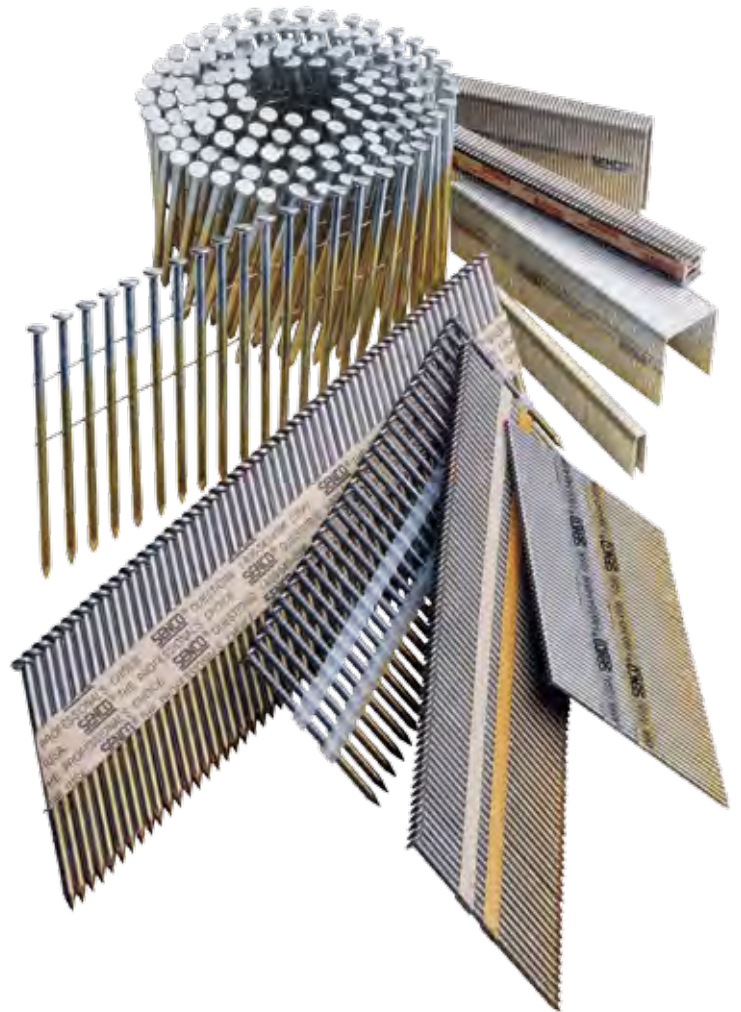

TABLE OF CONTENTS

See all tools at a glance in the foldout located on pages 90-92.



Auto-Feed Screwdrivers

DS215-18V, DS212-18V, DS312-18V, DS215-XP	3
DS235-AC, DS232-AC, DS332-AC	4
DS425AC, DS440AC	5
DS220, DS320	6
SG4100, SG2510	7
Collated Screws	8-11
Color Matched Metal Fasteners	12-13
Screw System Accessories	14-15



Hidden Deck System

SHD150XP, Clips, Fasteners	17
Clip Guide by Decking Manufacturer & Size	18
Clip Series, Tools & Accessories	19



Fusion

F18, F16-S, F16-A, F-15	21
Fasteners	22-23



Finish & Woodworking

FinishPro235XP, FinishPro23LXP	25
FinishPro21LXP, LS1XP, FinishPro18Mg, FinishPro18BMg	26
SLP20XP, FinishPro25XP	27
FinishPro32, FinishPro33Mg, SFN30	28
FinishPro35Mg, FinishPro42XP	29
SLS20XP, SLS25XP, SKSXP	30
SLS150Mg, SLS18Mg, SC1XP Senclamp, SC2 Sencor	31
Fasteners	32-37



Framing, Sheathing & Subfloors

FramePro325XP, FramePro701XP	39
FramePro325FRHXP, FramePro702XP, FramePro752XP	40
SCN60XP, SCN65XP, SCN49XP	41
JoistPro150XP, JoistPro250XP, Mini-Hand Nailers, A20 Hand Nailers	42
SCP40XP, WC150XP, WC200XP	43
SNS41, SNS200XP, SQS55XP	44
Fasteners	45-53



Roofing, Siding & Fencing

RoofPro455XP, RoofPro445XP, SCN49XP	55
WC150RXP, BC58, A11	56
Fasteners	57-59



Pallets & Crating

PalletPro57FXP, PalletPro100XP, PalletPro130XP	61
DFPXP, F75LXP, F75SXP	62
Fasteners	63-65



Upholstery & Furniture

SFT10XP Family	67
SFW09, SNS200XP-BST	68
Fasteners	69-71



Flooring

SHF200, SHFS200, SLS20XP-HF	73
Fasteners	74



Box, Carton & Pallet Conversion Fasteners

Nails, Staples, Screws, Hidden Deck Fasteners	75-77
---	-------



Air Compressors

PC0968N, PC0969, PC0970	79
PC1130, PC1131, PC0968, PC1280	80
PC1010, PC0947, PC1010N, PC0974	81



Accessories

Air Hoses	83
Plugs & Couplers, Swivel Plugs & Swivel Couplers	84-85
Air Hose & Compressor Accessories	86
Drain Cock, Filters, Regulators & Gauges	86
Oils & Lubricants	87
Safety Glasses & Tool Belt Hooks	87
Battery & Charger Systems, No-Mar Pads	88
Parts Kits	89



Miscellaneous

Fasteners at a Glance	90-91
Tools at a Glance	92-94
Fastener Finish Types	95

DURASPIN

DESIGNED TO MAKE YOU AS PRODUCTIVE AS POSSIBLE

DuraSpin® systems increase screw fastening speeds by more than four times versus bulk screwdrivers and loose screws, improving job site productivity by more than 30%. Now we are leading the way to even greater productivity gains with our next generation of tools and fasteners.

APPLICATIONS

Whether you choose an integrated tool or use our full line of kits and accessories, you can customize DuraSpin auto-feed screw systems for a variety of applications including drywall, flooring, decking and industrial projects. Check out our ICC certified collated screws for steel frame construction.

FEATURES

- Patented corner-fit feed system for better screw placement in tight spaces and corners
- Locking depth-of-drive adjustment
- Tool-free adjustable nosepiece
- Easily load 50 screws in less than a second
- Trigger lock, locks in RPM speed
- Long-lasting drive bits with quick-slide release



DS215-18V

2" CORDLESS 18V LI-ION 5000 RPM

ITEM #7W0001N



2 bits included



Features

- High-speed motor designed for drywall applications
- Patented feed system fits into corners
- EZ-Load feature for quick loading
- Includes 2 bits (as shown), drywall nosepiece FC0878, wood nosepiece FB0157, 2 batteries, charger and carrying bag

PRIMARY APPLICATIONS

Drywall to Wood, Drywall to Steel, Underlayment

SECONDARY APPLICATIONS

Cement Board

DS212-18V

2" CORDLESS 18V LI-ION 2500 RPM

ITEM #7X0001N



2 bits included



Features

- High-torque motor for driving into dense material
- Drives drill-point fasteners with variable-speed trigger
- Depth-of-drive lock ensures same countersink every time
- Includes 2 bits (as shown), drywall nosepiece FC0878, wood nosepiece FB0157, 2 batteries, charger and carrying bag

PRIMARY APPLICATIONS

Metal Framing, Cement Board

SECONDARY APPLICATIONS

Drywall to Wood, Drywall to Steel, Subfloor, Underlayment, Wood Decking, Sheathing to Steel

DS312-18V

3" CORDLESS 18V LI-ION 2500 RPM

ITEM #7Y0001N



2 bits included



Features

- Tool-free screw-length adjustment to set screw length quickly
- Load quickly and prevent misfeeds with patented screw strip guide
- Drive the complete range of SENC0 collated screws up to 3"
- Includes 2 bits (as shown), drywall nosepiece FC0895, wood nosepiece FB0159, 2 batteries, charger and carrying bag

PRIMARY APPLICATIONS

Wood Decking, Tile Roofing

SECONDARY APPLICATIONS

Drywall to Wood, Drywall to Steel, Subfloor, Metal Framing, Composite Decking, Cement Board, Sheathing to Steel

DS215-XP

2" 18V 3.0 AH LI-ION 5000 RPM

ITEM #7W0002N



2 bits included



Features

- Tool-free screw-length adjustment to set screw length quickly
- Patented feed system fits into corners
- Quick-slide button bit change
- Includes 2 bits (as shown), drywall nosepiece FC0878, wood nosepiece FB0157, two 3.0 Ah Li-Ion batteries, charger and carrying bag

PRIMARY APPLICATIONS

Drywall to Wood, Drywall to Steel

SECONDARY APPLICATIONS

Cement Board, Underlayment

Product Reference Chart

TOOL SPECS	DS215-18V	DS212-18V	DS312-18V	DS215-XP
Speed (RPM)	0-5000	0-2500	0-2500	0-5000
Voltage	18V	18V	18V	18V
Weight	5.9 lbs (2.7 kg)	5.34 lbs (2.41 kg)	6 lbs (27 kg)	5.9 lbs (2.7 kg)
Height	9.5" (241 mm)	9.5" (241 mm)	9.5" (241 mm)	10.1" (257 mm)
Length	15" (381 mm)	15" (381 mm)	16.4" (417 mm)	15" (381 mm)
Width	3.9" (99 mm)	3.9" (99 mm)	3.9" (99 mm)	3.9" (99 mm)
Warranty	1 yr	1 yr	1 yr	1 yr
FASTENER SPECS	Collated screws are located on pages 8-11.			
Range	1"-2"*	1"-2"*	1"-3"	1"-2"*
Shank Diameter	#6 - #8	#6 - #10	#6 - #10	#6 - #8
TOOL FEATURES				
Depth-of-Drive	Yes	Yes	Yes	Yes
Reversible Belt Hook	Yes	Yes	Yes	Yes
Trigger	Variable speed	Variable speed	Variable speed	Variable speed
Power Type	18V 1.5 Ah Compact Li-Ion	18V 1.5 Ah Compact Li-Ion	18V 1.5 Ah Compact Li-Ion	18V 3.0 Ah Li-Ion
Reversible	Yes	Yes	Yes	Yes

All cordless screwdrivers come with (2) 18V Li-Ion batteries (VB0155 or VB0161), charger (VB0156), drywall nosepiece, wood nosepiece and storage bag. *FC0822 nosepiece drives 1/2" to 2" screws.

DS235-AC

2" CORDED 5000 RPM

ITEM #7T0001N



2 bits included



Features

- High-speed motor designed for drywall applications
- Patented feed system fits into corners
- EZ-Load feature for quick loading
- Includes 2 bits (as shown), drywall nosepiece FC0878, wood nosepiece FB0157 and carrying bag

PRIMARY APPLICATIONS

Drywall to Wood, Drywall to Steel, Underlayment, Cement Board

SECONDARY APPLICATIONS

Subfloor, Wood Decking

DS232-AC

2" CORDED 2500 RPM

ITEM #7U0001N



2 bits included



Features

- High-torque motor for driving into dense material
- Drives drill-point fasteners with variable-speed trigger
- Depth-of-drive lock ensures same countersink every time
- Includes 2 bits (as shown), drywall nosepiece FC0878, wood nosepiece FB0157 and carrying bag

PRIMARY APPLICATIONS

Metal Framing, Cement Board

SECONDARY APPLICATIONS

Drywall to Wood, Drywall to Steel, Subfloor, Underlayment, Wood Decking, Composite Decking

DS332-AC

3" CORDED 2500 RPM

ITEM #7V0001N



2 bits included



Features

- Tool-free screw-length adjustment to set screw length quickly
- Load quickly and prevent misfeeds with patented screw strip guide
- Drive the complete range of SENC0 collated screws up to 3"
- Includes 2 bits (as shown), drywall nosepiece FC0895, wood nosepiece FB0159 and carrying bag

PRIMARY APPLICATIONS

Wood Decking, Composite Decking, Sheathing to Steel

SECONDARY APPLICATIONS

Drywall to Wood, Drywall to Steel, Subfloor, Underlayment, Metal Framing, Cement Board

Product Reference Chart

TOOL SPECS	DS235-AC	DS232-AC	DS332-AC
Speed (RPM)	0-5000	0-2500	0-2500
Current (Amps)	6.0	6.0	6.0
Voltage	120V/60Hz	120V/60Hz	120V/60Hz
Weight	5.7 lbs (2.6 kg)	5.8 lbs (2.6 kg)	5.9 lbs (2.7 kg)
Height	9.5" (241 mm)	9.5" (241 mm)	9.5" (241 mm)
Length	16.4" (417 mm)	16.4" (417 mm)	17.3" (439 mm)
Width	3.4" (86 mm)	3.4" (86 mm)	3.4" (86 mm)
Warranty	1 yr	1 yr	1 yr
FASTENER SPECS	Collated screws are located on pages 8-11.		
Range	1"-2"*	1"-2"*	1"-3"
Shank Diameter	#6 - #10	#6 - #12	#6 - #12
TOOL FEATURES			
Depth-of-Drive	Yes	Yes	Yes
Reversible Belt Hook	Yes	Yes	Yes
Trigger	Variable speed	Variable speed	Variable speed
Power Type	Corded	Corded	Corded
Reversible	Yes	Yes	Yes

All corded screwdrivers come with drywall nosepiece, wood nosepiece and storage bag. *FC0822 nosepiece drives 1/2" to 2" screws.

DS425AC

3" ATTACHMENT KIT WITH 2500 RPM SCREWDRIVER

ITEM #6W0012N



3 bits included



Features

- 3 Tools in 1, providing configurations for multiple applications
- High-torque motor powerful enough for any application
- EZ-Load feature for quick loading
- Prevent misfeeds with patented sliding rail system
- Includes SG2510 screwdriver, DS320 attachment, adaptor, 3 bits (as shown) and storage bag

PRIMARY APPLICATIONS

Wood and Composite Decking, Cement Board, Sheathing to Steel

SECONDARY APPLICATIONS

Drywall to Wood, Drywall to Steel, Subfloor, Underlayment, Metal Framing

DS440AC

3" ATTACHMENT KIT WITH 4000 RPM SCREWDRIVER

ITEM #6W0011N



3 bits included



Features

- 3 Tools in 1, providing configurations for multiple applications
- High-speed motor designed for subfloor applications
- EZ-Load feature for quick loading
- Prevent misfeeds with patented sliding rail system
- Includes SG4100 screwdriver, DS320 attachment, adaptor, 3 bits (as shown) and storage bag

PRIMARY APPLICATIONS

Subfloor, Underlayment, Wood Decking, Cement Board

SECONDARY APPLICATIONS

Drywall to Wood, Drywall to Steel

Product Reference Chart

TOOL SPECS	DS425AC	DS440AC
Speed (RPM)	0-2500	0-4000
Current (Amps)	6.5	6.5
Weight	7 lbs (3.2 kg)	6.8 lbs (3.1 kg)
Height	7.5" (191 mm)	7.5" (191 mm)
Length	20.5" (521 mm) 40" (1016 mm) w/ext. pole	20.5" (521 mm) 39.5" (1003 mm) w/ext. pole
Width	2.5" (64 mm)	2.5" (64 mm)
Warranty	1 yr	1 yr
FASTENER SPECS	Collated screws are located on pages 8-11.	
Range	1"-3"	1"-3"
Shank Diameter	#6 - #12	#6 - #12
TOOL FEATURES		
Depth-of-Drive	Yes	Yes
Belt Hook	Yes	Yes
Trigger	Variable with lock	Variable with lock
Power Type	Corded	Corded
Reversible	Yes	Yes

3 Tools in 1

Quickly and easily convert your DS425AC or DS440AC auto-feed attachment kit into 3 tools for multiple applications.



1. Use the screwdriver to drive loose screws.



2. Use the attachment for multiple auto-feed applications.

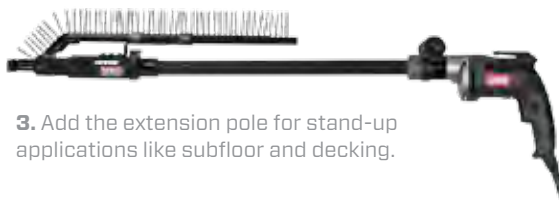

3. Add the extension pole for stand-up applications like subfloor and decking.

DS220

2" AUTO-FEED SCREWDRIVER ATTACHMENT

ITEM #6W0001N



Features

- Prevent misfeeds with patented sliding rail system
- Depth-of-drive lock ensures same countersink every time
- Attaches to your screwdriver with our full line of adapters (sold separately)
- Includes 2" attachment, drywall nosepiece FC0878 and wood nosepiece FB0157

PRIMARY APPLICATIONS

Drywall to Wood, Drywall to Steel, Metal Framing, Cement Board, Sheathing to Steel

SECONDARY APPLICATIONS

Subfloor, Underlayment, Wood Decking, Composite Decking

Bits and adapters sold separately

DS320

3" AUTO-FEED SCREWDRIVER ATTACHMENT

ITEM #6W0003N



Features

- Prevent misfeeds with patented sliding rail system
- Perfect for stand-up applications using extension pole and adjustable handle
- Attaches to your screwdriver with our full line of adapters (sold separately)
- Includes 3" attachment, extension pole, adjustable handle, drywall nosepiece FC0895 and wood nosepiece FB0159

PRIMARY APPLICATIONS

Subfloor, Underlayment, Wood Decking, Composite Decking, Cement Board, Sheathing to Steel

SECONDARY APPLICATIONS

Drywall to Wood, Drywall to Steel, Metal Framing

Bits and adapters sold separately

Product Reference Chart

TOOL SPECS	DS220	DS320
Weight	1.5 lbs (.68 kg)	3.3 lbs (1.5 kg)
Height	3.3" (84 mm)	3.3" (84 mm)
Length	21" (533 mm)	21" (533 mm)
Width	2.5" (64 mm)	2.5" (64 mm)
Warranty	1 yr	1 yr
FASTENER SPECS	Collated screws are located on pages 8-11.	
Range	1"-2"*	1"-3"
Shank Diameter	#6 - #12	#6 - #12
TOOL FEATURES		
Depth-of-Drive	Yes	Yes

Additional screwdrivers, bits and adaptors sold separately — see pg. 14-15
 *FC0822 nosepiece drives 1/2" to 2" screws.

Adapters for over 32 screwdriver motors

including DeWALT®, Makita®, HITACHI and SIOUX™.



SG4100

HIGH-PERFORMANCE 4000 RPM SCREWDRIVER

ITEM #6X0004N



2 bits included



Features

- High-speed motor designed for drywall applications
- Industrial-grade metal gear housing designed to sustain heavy usage
- Great for all-day use with ergonomic, lightweight and compact design
- Trigger lock for continuous operation
- Industrial-grade 10' cord
- Includes 2 bits (as shown)

PRIMARY APPLICATIONS

Drywall to Wood, Drywall to Steel, Subfloor, Underlayment, Cement Board

SECONDARY APPLICATIONS

Wood Decking

SG2510

HIGH-PERFORMANCE 2500 RPM SCREWDRIVER

ITEM #6X0002N



2 bits included



Features

- High-torque motor for driving into dense materials
- Industrial-grade metal gear housing designed to sustain heavy usage
- Great for all-day use with ergonomic, lightweight and compact design
- Trigger lock for continuous operation
- Industrial-grade 10' cord
- Includes 2 bits (as shown)

PRIMARY APPLICATIONS

Composite Decking, Wood Decking, Cement Board, Sheathing to Steel, Metal Framing

SECONDARY APPLICATIONS

Drywall to Wood, Drywall to Steel, Subfloor, Underlayment

Nosepieces and drive bits for every application:

drywall, wood, wood to metal and metal to metal.



Product Reference Chart



TOOL SPECS	SG4100	SG2510
Speed (RPM)	0-4000	0-2500
Current (Amps)	6.5	6.5
Weight	3.6 lbs (1.6 kg)	3.4 lbs (1.5 kg)
Height	7.5" (191 mm)	7.5" (191 mm)
Length	12" (305 mm)	12.5" (318 mm)
Width	2.5" (64 mm)	2.5" (64 mm)
Warranty	1 yr	1 yr
TOOL FEATURES		
Depth-of-Drive	Yes	Yes
Belt Hook	Yes	Yes
Trigger	Variable speed	Variable speed
Power Type	Corded	Corded
Reversible	Yes	Yes

Drywall to Wood Screws

Sharp point drywall screws for fastening interior drywall to wood

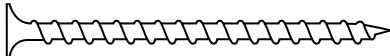
Finish: Gray Phosphate



 #2 Phillips
  Bugle
  Sharp

Gauge	Length	Thread	Quantity	Item Code
#6	1 1/4"	Coarse	1000 Tub	06A125P
#6	1 1/4"	Coarse	4000 Box	06A125PB
#6	1 1/2"	Coarse	1000 Tub	06A162P
#6	1 1/2"	Coarse	4000 Box	06A162PB
#7	2"	Coarse	1000 Tub	07A200P
#8	2 1/2"	Coarse	1000 Box	08A250PK

Finish: Exterior

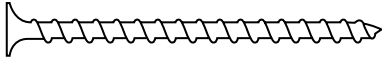





Gauge	Length	Thread	Quantity	Item Code
#6	1 1/4"	Coarse	1000 Tub	06A162W

Drywall to Light Steel Screws

Sharp point, fine-thread drywall screws for fastening interior drywall to light-gauge metal studs

Finish: Gray Phosphate



 #2 Phillips
  Bugle
  Sharp



Gauge	Length	Thread	Quantity	Item Code
#6	1 1/4"	Double Thread	1000 Tub	06B125P*
#6	1 1/4"	Double Thread	4000 Box	06B125PB*
#6	1 1/2"	Double Thread	1000 Tub	06B162P*

Gypsum to Heavy Steel Screws

Drywall screws with self-drilling point for fastening drywall or gypsum sheathing to heavy-gauge metal studs

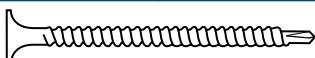
Finish: Clear Zinc



 #2 Phillips
  Bugle
  Drill

Gauge	Length	Thread	Quantity	Item Code
#6	1"	Fine	1000 Tub	06C100C*
#6	1 1/4"	Fine	1000 Tub	06C125C*
#6	1 1/4"	Fine	4000 Box	06C125CB*
#6	1 1/2"	Fine	1000 Tub	06C162C*
#6	1 1/2"	Fine	4000 Box	06C162CB*
#6	2"	Fine	1000 Tub	06C200C*

Finish: Exterior

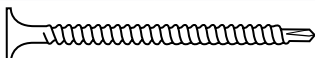

Gauge	Length	Thread	Quantity	Item Code
#6	1 1/4"	Fine	1000 Box	06C125WK*
#6	1 1/2"	Fine	1000 Box	06C162WK*
#8	3"	3/8 Fine	1000 Box	08C300WK

Finish: Gray Phosphate

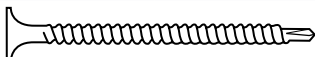





Gauge	Length	Thread	Quantity	Item Code
#6	1 1/4"	Fine	4000 Box	06C125PB*
#6	1 1/2"	Fine	4000 Box	06C162PB*
#6	2"	Fine	4000 Box	06C200PB*

Wood to Wood Screws

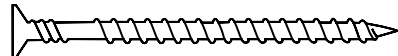
General purpose interior wood screws

Finish: Yellow Zinc





 #2 Square
  Flat
  Sharp

Gauge	Length	Thread	Quantity	Item Code
#8	1 1/2"	Coarse	1000 Tub	08F150Y
#8	1 3/4"	3/8 Coarse	1000 Tub	08F175Y
#8	2"	3/8 Coarse	1000 Tub	08F200Y
#8	2 1/2"	3/8 Coarse	800 Tub	08F250Y
#8	2 1/2"	3/8 Coarse	1000 Box	08F250YK
#8	3"	3/8 Coarse	800 Tub	08F300Y
#8	3"	3/8 Coarse	1000 Box	08F300YK
#10	2"	3/8 Coarse	800 Tub	10F200Y

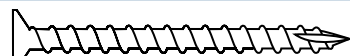
Finish: Yellow Zinc





 #2 Square
  Flat
  Type 17

Gauge	Length	Thread	Quantity	Item Code
#8	1 1/4"	Coarse	4000 Box	08L175YB

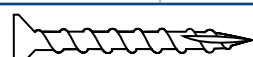
Finish: Clear Zinc







 #2 Square
  Flat
  Type 17

Gauge	Length	Thread	Quantity	Item Code
#8	1 1/4"	Coarse	4000 Box	08L125CBLCTS

Interior wood screws for harder-engineered lumber and flooring materials

Finish: Yellow Zinc



 #2 Square
  Trim Head + Nibs
  Sharp



Gauge	Length	Thread	Quantity	Item Code
#8	2"	High Low	4000 Box	08F200YBTHSS

Underlayment Screws

Trim head screws for underlayment, wood to wood and crating/pallet applications

Finish: Gray Phosphate





 #2 Phillips
  Trim Head + Nibs
  Sharp

Gauge	Length	Thread	Quantity	Item Code
#7	1"	High Low	4000 Box	07Q100PB
#7	1 1/4"	High Low	4000 Box	07Q125PB

Finish: Gray Phosphate



 #2 Square
  Trim Head + Nibs
  Sharp

Gauge	Length	Thread	Quantity	Item Code
#7	1 1/4"	High Low	4000 Box	07Q125PBQ



*ICC certified test data available on all highlighted items. Refer to ESR-3558 for details.

COLLATED SCREWS

Wood to Heavy Steel Screws

Pilot point screws for fastening sheathing to heavy steel

Finish:
Clear Zinc

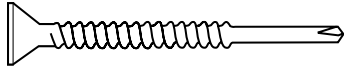

Gauge	Length	Thread	Quantity	Item Code
#8	2"	Fine	1000 Box	08G200CKLFPS

Wing drill point screws for fastening sheathing to heavy steel

Finish:
Clear Zinc



Gauge	Length	Thread	Quantity	Item Code
#8	1 1/2"	Fine	1000 Tub	08G162CTWFWS
#10	1 1/2"	Fine	1000 Tub	10G162CTWFWS
#8	2"	Fine	1000 Tub	08G200CTWFWS
#8	2 1/2"	Fine	800 Tub	08G250CTWFWS
#8	3"	Fine	800 Tub	08G300CTWFWS

Finish:
Exterior



Gauge	Length	Thread	Quantity	Item Code
#8	2"	Fine	1000 Tub	08G200WTWFWS

Low profile screw head for fastening sheathing to steel

Finish:
Clear Zinc

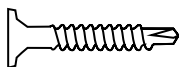

Gauge	Length	Thread	Quantity	Item Code
#8	1"	Fine	1000 Box	08G100CKNFDP*

Low profile screw head for fastening sheathing to steel

Finish:
Clear Zinc

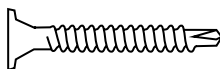

Gauge	Length	Thread	Quantity	Item Code
#8	1"	Fine	4000 Box	08G100CBWFDS
#10	1 1/4"	Fine	4000 Box	10G125CBWFDS

Wing drill point screws for fastening sheathing to heavy steel structures

Finish:
Yellow Zinc



Gauge	Length	Thread	Quantity	Item Code
#12	1 1/4"	Fine	1000 Box	12G175YKLFAX

Wing drill point screws for fastening sheathing to heavy steel structures

Finish:
Yellow Zinc



Gauge	Length	Thread	Quantity	Item Code
#12	2"	Fine	1000 Box	12G200YKLFAX
#12	2 1/2"	Fine	1000 Box	12G250YKLFAX

Wood to Light Steel Screws

Sharp point screws for fastening sheathing to light steel

Finish:
Clear Zinc



Gauge	Length	Thread	Quantity	Item Code
#8	1 1/2"	Double	1000 Tub	08G150CTLDSS

Cement Board Screws

Screws for fastening cement board or Hardie® board to wood

Finish:
Exterior



Gauge	Length	Thread	Quantity	Item Code
#8	1 1/4"	High Low	1000 Tub	08T125W
#8	2"	High Low	1000 Tub	08T200W

Screws for fastening cement board or Hardie® board to steel studs

Finish:
Exterior



Gauge	Length	Thread	Quantity	Item Code
#8	1 1/2"	Fine	4000 Box	08T150WBWFDS

Decking and Dock Screws

Exterior wood screws for projects such as decks, tile roofing, fencing, siding and docks

Finish:
Exterior

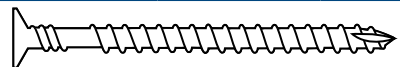

Gauge	Length	Thread	Quantity	Item Code
#8	1 1/4"	3/8 Coarse	1000 Tub	08D175W
#8	2"	3/8 Coarse	1000 Tub	08D200W
#8	2 1/2"	3/8 Coarse	800 Tub	08D250W
#8	2 1/2"	3/8 Coarse	1000 Box	08D250WK
#8	3"	3/8 Coarse	800 Tub	08D300W
#8	3"	3/8 Coarse	1000 Box	08D300WK

Finish:
Stainless 304

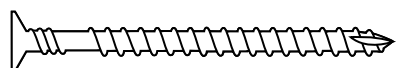

Gauge	Length	Thread	Quantity	Item Code
#8	2 1/2"	3/8 Coarse	800 Tub	08D250S
#9	3"	3/8 Coarse	800 Tub	09D300S





MIAMI-DADE COUNTY
APPROVED



*ICC certified test data available on all highlighted items. Refer to ESR-3558 for details.

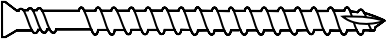

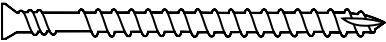

Composite Decking Screws

Trim head screws for fastening composite decking to wood

Finish: Exterior				
		 #2 Square	 Trim	 Type 17
Gauge	Length	Thread	Quantity	Item Code
#8	2½"	¾ Coarse	800 Tub	08R250W
#8	3"	¾ Coarse	800 Tub	08R300W

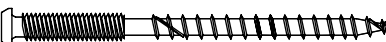
Finish: Stainless 304				
Gauge	Length	Thread	Quantity	Item Code
#8	2½"	¾ Coarse	800 Tub	08R250S

Specially designed cup head screws eliminate mushrooming around screw head after installation

Finish: Exterior/Gray				
		 #2 Square	 Cupped Pan	 Sharp
Gauge	Length	Thread	Quantity	Item Code
#8	2½"	Multi-Thread	800 Tub	08S250W003
#8	3"	Multi-Thread	800 Tub	08S300W003

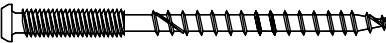
Finish: Exterior/Tan				
Gauge	Length	Thread	Quantity	Item Code
#8	2½"	Multi-Thread	800 Tub	08S250W592
#8	3"	Multi-Thread	800 Tub	08S300W592

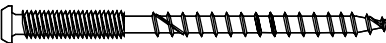
Finish: Exterior/Red				
Gauge	Length	Thread	Quantity	Item Code
#8	2½"	Multi-Thread	800 Tub	08S250W596
#8	3"	Multi-Thread	800 Tub	08S300W596

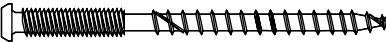



Finish: Exterior/Brown				
Gauge	Length	Thread	Quantity	Item Code
#8	2½"	Multi-Thread	800 Tub	08S250W497
#8	3"	Multi-Thread	800 Tub	08S300W497





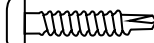



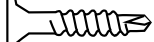

*ICC certified test data available on all highlighted items. Refer to ESR-3558 for details.





Metal to Metal Screws





General purpose screws for fastening metal to metal





Finish: Clear Zinc				
		 #2 Square	 Modified Flat Pan	 Drill
Gauge	Length	Thread	Quantity	Item Code
#10	¾"	Fine	1000 Tub	10M075CTMFD5*
#10	1"	Fine	1000 Box	10M100CKMFD5*



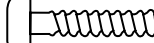

Finish: Clear Zinc				
		 #2 Phillips	 Reduced Wafer	 Drill
Gauge	Length	Thread	Quantity	Item Code
#10	¾"	Fine	1000 Box	10M075CKNFDP*

Finish: Yellow Zinc				
		 Rex	 Flat Pan	 Drill
Gauge	Length	Thread	Quantity	Item Code
#10	¾"	Fine	1000 Tub	10M075YTFFDX*

Finish: Yellow Zinc				
		 Rex	 Flat Pan	 T4 Drill
Gauge	Length	Thread	Quantity	Item Code
#10	¾"	22 TPI	8000 Loose	10M075YLF4X*
#10	¾"	22 TPI	1000 Box	10M075YKF4X*













Finish: Yellow Zinc				
		 Rex	 Flat Pan	 T4 Drill
Gauge	Length	Thread	Quantity	Item Code
#12	7/8"	Fine	1000 Box	12M087YKFF4X*

Finish: Yellow Zinc				
		 Rex	 Flat Pan	 T3 Drill
Gauge	Length	Thread	Quantity	Item Code
#12	1"	Fine	1000 Box	12M100YKFF3X*





Finish: Clear Zinc				
		 Rex	 Flat Pan	 Drill
Gauge	Length	Thread	Quantity	Item Code
#10	¾"	Fine	6000 Box	10M062CBFFDX*
#12	1½"	Fine	1000 Tub	12M150CTFFDX*

COLLATED SCREWS

Light Metal Framing Screws

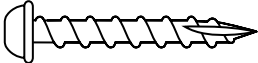
Self tapping metal framing screw				
Finish: Gray Phosphate				
		 #2 Phillips	 Pan Framing	 Sharp
Gauge	Length	Thread	Quantity	Item Code
#7	3/8"	Double	1000 Tub	07M044PTDPS
Finish: Clear Zinc				
		 #2 Phillips	 Reduced Mod Truss	 Sharp
		ICC ES		
Gauge	Length	Thread	Quantity	Item Code
#8	1/2"	Fine	1000 Tub	08M050CTRFSP*
Self drilling and-tapping metal framing screws				
Finish: Clear Zinc				
		 #2 Phillips	 Reduced Mod Truss	 Drill
		ICC ES		
Gauge	Length	Thread	Quantity	Item Code
#8	1/2"	Fine	1000 Tub	08M050CTRFDP*

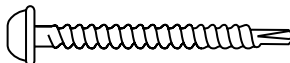
Specialty Screws

General purpose screws for a range of applications including window installation and crating				
Finish: Clear Zinc				
		 #2 Square	Round Washer	Type 17
Gauge	Length	Thread	Quantity	Item Code
#8	1 1/4"	Coarse	4000 Box	08X125CBACTS
Finish: Clear Zinc				
		 #2 Square	Round Washer	Drill
		ICC ES		
Gauge	Length	Thread	Quantity	Item Code
#8	1 1/4"	Double	1000 Box	08X125CKADD*
#8	2"	Double	1000 Box	08X200CKADD*



* ICC certified test data available on all highlighted items. Refer to ESR-3558 for details.

The New Standard in Professional Auto-Feed Screw Systems

INCREASE JOB SITE PRODUCTIVITY BY 30%!

4X faster than corded screwdrivers with loose screws*

- DuraSpin Auto-Feed Screw Systems eliminate the need to reach for fasteners and position them on a magnetic screw tip.
- DuraSpin allows for one-handed screw fastening with either hand, freeing the other hand to steady your work.

*DuraSpin Screw Fastening System Time & Motion Study. July, 2001. R.S.MEANS. CONSULTING SERVICES.



COLOR MATCHED METAL FASTENERS

PAINTED FASTENERS FOR EXTERIOR METAL ATTACHMENT

SENCO now offers a variety of colors in our new DuraSpin specialty metal to metal collated screws developed for the cargo trailer industry.

BENEFITS

- Increases productivity over loose screws
- Produces perfectly flat seams —
No unsightly bubbles
- Improved holding power
- No dropped fasteners = no flat tires

FEATURES











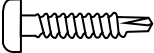

- E1000 Finish
- Square or Rex Drive
- Available in 3/4" or 5/8" collated & 7/8" loose



COLOR MATCHED METAL FASTENERS

Specialty Metal to Metal Painted Screws

Specialty metal to metal screw for securing trailer skins

Finish: E1000				
	 #2 Square  Pan Framing  Drill	 Rex  Pan Framing  Drill	 #2 Square  Pan Framing  T4 Drill	 Rex  Pan Framing  T4 Drill
	#10 x 3/4"	#10 x 5/8"	#12 x 7/8"	#12 x 7/8"
Clear	10M075EBMFDS	10M062EBFFDX	12M087ELFF4S	12M087ELFF4X
Black	10M075E000BMFDS	10M062E000BFFDX	12M087E000LFF4S	12M087E000LFF4X
White	10M075E111BMFDS	10M062E111BFFDX	12M087E111LFF4S	12M087E111LFF4X
Charcoal Gray	10M075E001	10M062E001	12M087E001S	12M087E001X
Silver Frost	10M075E002	10M062E002	12M087E002S	12M087E002X
Pewter	10M075E003	10M062E003	12M087E003S	12M087E003X
Brandy Wine	10M075E004	10M062E004	12M087E004S	12M087E004X
Orange	10M075E005	10M062E005	12M087E005S	12M087E005X
Yellow	10M075E006	10M062E006	12M087E006S	12M087E006X
Red	10M075E007	10M062E007	12M087E007S	12M087E007X
AZ Beige	10M075E008	10M062E008	12M087E008S	12M087E008X
Indigo Blue	10M075E009	10M062E009	12M087E009S	12M087E009X
Emerald Green	10M075E010	10M062E010	12M087E010S	12M087E010X
Dove Gray	10M075E011	10M062E011	12M087E011S	12M087E011X
Packaging	4000 box	6000 box	150 Clamshell	150 Clamshell

Painted Screws Color

													
Clear	Black	White	Charcoal Gray	Silver Frost	Pewter	Brandy Wine	Orange	Yellow	Red	AZ Beige	Indigo Blue	Emerald Green	Dove Gray

Bits

Integrated auto-feed screw systems — 2 bits per pack			
Bits Fit	⊕ ITEM #	◻ ITEM #	⊛ ITEM #
DS200-AC DS202-14V DS205-14V	EA0122	EA0123	EA0269
DS212-18V DS215-18V DS232-AC DS235-AC	EA0297	EA0298	EA0299
DS275-18V DS300-AC	EA0140	EA0141	EA0270
DS312-18V DS332-AC	EA0300	EA0301	EA0302
25 count packaging for the high output professional user*			
DS212-18V DS215-18V DS232-AC DS235-AC	EA0297N	EA0298N	EA0299N
DS312-18V DS332-AC		EA0301N	
Auto-feed attachment kits — 2 bits per pack			
Bits Fit	⊕ ITEM #	◻ ITEM #	⊛ ITEM #
DS325AC DS340AC	EA0271	EA0272	EA0273
DS425AC DS440AC	EA0314	EA0315	EA0316



High output
25 per pack

Bits

Screwdriver and attachment combinations — 2 bits per pack			
Bit Fit	⊕ ITEM #	◻ ITEM #	⊛ ITEM #
SENCO SG2510 and Senco SG4100			
+ DS110	EA0277	EA0278	EA0279
+ DS210	EA0277	EA0278	EA0279
+ DS220	EA0311	EA0312	EA0313
+ DS310	EA0271	EA0272	EA0273
+ DS320	EA0314	EA0315	EA0316
Makita with adapters ADP019 and MB0174			
+ DS110	EA0277	EA0278	EA0279
+ DS210	EA0277	EA0278	EA0279
+ DS220	EA0311	EA0312	EA0313
+ DS310	EA0271	EA0272	EA0273
+ DS320	EA0314	EA0315	EA0316
Black & Decker, DeWalt, Hitachi, TY1800 with adapter ADP014 Makita with adapters ADP011 and ADP020			
+ DS110	EA0280	EA0281	EA0282
+ DS210	EA0280	EA0281	EA0282
+ DS220	EA0317	EA0318	EA0319
+ DS310	EA0274	EA0275	EA0276
+ DS320	EA0320	EA0321	EA0322
25 count packaging for the high output professional user*			
SENCO SG2510 and Senco SG4100, Makita with adapters ADP019 and MB0174			
+ DS220		EA0312N	EA0313N
+ DS320		EA0315N	EA0316N

Bit Tips

Loose screwdriver — 10 bits per pack		
Bits Fit	⊛ ITEM #	
SG2510 SG4100	EA0308	

Bit Tips & Holders

Auto-feed screw system — 5 bit tips and 1 holder per pack		
Bit Tip Holders Fit	ITEM #	
DS200-AC DS202-14V DS205-14V	WC0067	
DS275-18V DS300-AC	WC0070	
Bit Tips Fit	⊕ Bit Tips ITEM #	◻ Bit Tips ITEM #
DS200-AC DS202-14V DS205-14V	EA0142	EA0143
DS275-18V DS300-AC		

Adapters

For attaching screwdrivers to attachments			
Screwdriver	Fits Tools		Adapter ITEM #
SENCO	SG2510	SG4100	MB0173
	SG2500	SG4000	ADP015
DeWalt	DW252	DW266	ADP009
	DW253	DW272	
	DW255	DW276	
	DW257		
MAKITA	FS2200	FS4200	ADP019
	FS2500	FS6200	
	FS2701		MB0174
	6805BV	6827	ADP020
	6820 6821 6823	6824 6825 68261	ADP011
HITACHI	W6V4 W6VA4 W6VB3	W6VM W8VB2	ADP010
	WH14DM		ADP017
SIoux	Screwdrivers with 1/4" internal hex feature		ADP018



*High output impact feature is designed to extend bit life in metal applications

SCREW SYSTEM ACCESSORIES

Nosepieces

For wood applications			For drywall applications			For metal framing applications		
Fits Tools	Range	ITEM #	Fits Tools	Range	ITEM #	Fits Tools	Range	ITEM #
DS200-AC DS202-14V	1"-2"	FA0211	DS200-AC DS202-14V	1"-2"	FA0198	DS212-18V DS215-18V DS220 DS232-AC DS235-AC	½"-1"	FB0155
DS212-18V DS215-18V DS220 DS232-AC DS235-AC	1"-2"	FB0157	DS212-18V DS215-18V DS220 DS232-AC DS235-AC	1"-2"	FC0878	DS212-18V DS215-18V DS220 DS232-AC DS235-AC	½"-2"	FC0822
DS312-18V DS320 DS332-AC DS425AC DS440AC	1"-3"	FB0159	DS312-18V DS320 DS332-AC DS425AC DS440AC	1"-3"	FC0895	DS312-18V DS320 DS332-AC DS425AC DS440AC	½"-3"	FC0887

Nosepieces & Metal Washers

For lath, plaster, PM, stucco, one-coat and hard-coat applications			
Fits Tools	Fits Tools	Range	ITEM #
SENCO	DS212-18V DS215-18V DS235-AC DS232-AC DS220	1"-2"	FB0167

Metal Washer

ITEM #	Diameter	Box Count	Fits Screw Series
SWM125A	1¼"	1M	06A, 06B, 06C, 07A

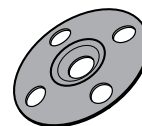

Nosepieces & Plastic Washers



For building wrap and EIFS installation			
Fits Tools	Fits Tools	Range	ITEM #
SENCO	DS212-18V DS215-18V DS235-AC DS232-AC DS220	1"-2"	FB0170
SENCO	DS312-18V DS320 DS332-AC DS425AC DS440AC	1"-3"	FB0168

Plastic Washer

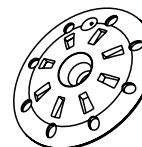
ITEM #	Diameter	Box Count	Fits Screw Series
SWP175A	1¾"	1M	06A, 06B, 06C, 07A (forms seal around screw)



Battery Systems

Compatible with all 18V Li-Ion DuraSpin and SENC FUSION tools		
18V Li-Ion Battery 1.5 amp hour	Fits	
VB0155	DS212-18V DS215-18V DS312-18V DS215-XP All Fusion Models	 <ul style="list-style-type: none"> • 1.5 amp hour • High-quality reliable cells • Longer storage life • Charges 80% in 15 minutes
18V Li-Ion Battery 3.0 amp hour	Fits	
VB0161	DS212-18V DS215-18V DS312-18V DS215-XP All Fusion Models	 <ul style="list-style-type: none"> • 3.0 amp hour • High-quality reliable cells • Longer storage life • Drives up to 2X as many fasteners as VB0155

Charger System

Can be used interchangeably with SENC VB0155, VB0161 and VB0118 batteries		
Battery Charger	For use with	
VB0156	VB0155 VB0161 VB0118	 <ul style="list-style-type: none"> • Battery charge indicators display charge status of your battery • Compatible with all SENC 18V Li-Ion batteries

HIDDEN DECK SYSTEM

FOR GROOVED DECK BOARDS

The newest generation of hidden deck fasteners, featuring Mantis® technology, provides a hidden fastener solution for grooved decking made from PVC, composites or wood products.

Benefits of SENCO® Hidden Deck Fastening System Include:

- No visible fasteners — Unique starter and finish clips ensure an unblemished deck surface.
- Reduced potential for mildew and rot — Clips elevate the deck board off joists for proper airflow and drying.
- Uniform installation and appearance — Clips automatically space deck boards 3/16" apart to help ensure even spacing.
- High strength steel fasteners — Unique coating process for corrosion resistance. Recommended for use with ACQ and other treated lumber joists.
- 30 year limited warranty against loose deck boards — Leading performance in hold down and lateral movement.



SHD150XP

MANTIS HIDDEN DECK CLIP NAILER

ITEM #9D0001N



Features

- Designed specifically for installation of Mantis brand deck clips
- Integrated EZ-slide attachment guides and aligns deck clips
- Industrial strength magnet keeps deck clip in place until installed
- Dry-fire lockout
- Rotatable rafter hanger
- Includes wrenches, tool oil, safety glasses and air plug

Product Reference Chart

TOOL SPECS	SHD150XP
Trigger	Sequential
Operating Pressure	70-120 psi (4.8-8.3 bar)
Air Consumption (60 CPM)	2.3 scfm
Air Inlet	¼" NPT
Weight	4.6 lbs (2.08 kg)
Height	12.25" (311 mm)
Length	15.13" (384 mm)
Width	4" (102 mm)
Main Body Material	Magnesium
Warranty	5 yrs
TOOL FEATURES	
Depth-of-Drive	No
Rafter Hook	Adjustable
Dry Fire Lockout	Yes
Exhaust	Adjustable





Clips

Deck clips and starter clips are designed to fit the most common groove heights in slotted PVC, composite or wood

Type	For	
Deck Clips	.380" groove use 385 Deck Clip Series .406" groove use 396 Deck Clip Series .396" groove use TRX Deck Clip Series	
Starter Clips	.380" groove use 385 Starter Clip Series .406" groove use 396 Starter Clip Series .396" groove use TRX Starter Clip Series	
Finish clips are universal		
Finish Clips	HDFC25 Finish Clips fit all board sizes	

Fasteners

Loose screws can be used with any loose screwdriver and #2 square bit

Type	For	
Loose Screws	 #2 Square bit	
Reversible fasteners are uniquely engineered to be driven in like a traditional collated nail, but can be backed out like a traditional screw using a #1 square bit		
Collated Reversible Fasteners (Driven with SHD150XP)	 #1 Square bit	

HIDDEN DECK CLIP SYSTEM

Clip Guide by Decking Manufacturer & Size

All clips are designed for specific groove heights in deck boards. Use the chart below to find the series for your boards.

Clip Style	385	396	TRX
Clip Groove Height	.380"	.406"	.396"
COMPOSITE MANUFACTURERS			
AERT (Moistureshield®, ChoiceDek®, Modern View™)		●	
EVERNEW® LT	●		
FIBERON® (Horizon®, Pro Tect Advantage®, Professional, Veranda®)	●		
LATITUDES® (UFPI) (Captiva™, Capricom®, Wave)	●		
NATURE'S COMPOSITES®		●	
TIMBERTECH® (Evolutions®, Twin Finish®, Terrain)	●		
TREX® (Transcend®, Enhance®, Select®, Accents®)			●
WOLF HOME PRODUCTS® (Island Collection)	●		
GROOVED PVC MANUFACTURERS			
AZEK® (Tropical Collection, Natural Collection)	●		
GOSSEN®/WEATHER READY (American Classic, Trailways, Passport)		●	
DECEUNINCK (Solstice®, Clubhouse)		●	
TUFBOARD® (Aisek, Bellus, Cierra, ECO, Kinbo)		●	
ROYAL/CENTURY (Royal Deck)		●	
ALTERNATIVE DECKING MANUFACTURER			
NYLODECK®	●		
For any .380" groove height	●		
For any .406" groove height		●	
For any .396" groove height			●

HIDDEN DECK CLIP SYSTEM

Hidden Deck Clips, Tools & Accessories

385 Series — Groove height = .380"					
Description	Collation	Pack Type	Pieces per Pack	Included	Item Code
MANTIS 385 Clips w/Screws (50 ft ²)	Loose Screws	Box	90	Includes 5 Starter & 5 Finish Clips	HDL38590
MANTIS 385 Clips w/Screws (250 ft ²)	Loose Screws	Bucket	450	Starter & Finish Clips Sold Separately	HDL385450
MANTIS 385 Clips w/Fasteners (50 ft ²)	Collated Fasteners	Box	90	Includes 5 Starter & 5 Finish Clips	HDC38590
MANTIS 385 Clips w/Fasteners (250 ft ²)	Collated Fasteners	Bucket	450	Starter & Finish Clips Sold Separately	HDC385450
396 Series — Groove height = .406"					
Description	Collation	Pack Type	Pieces per Pack	Included	Item Code
MANTIS 396 Clips w/Screws (50 ft ²)	Loose Screws	Box	90	Includes 5 Starter & 5 Finish Clips	HDL39690
MANTIS 396 Clips w/Screws (250 ft ²)	Loose Screws	Bucket	450	Starter & Finish Clips Sold Separately	HDL396450
MANTIS 396 Clips w/Fasteners (50 ft ²)	Collated Fasteners	Box	90	Includes 5 Starter & 5 Finish Clips	HDC39690
MANTIS 396 Clips w/Fasteners (250 ft ²)	Collated Fasteners	Bucket	450	Starter & Finish Clips Sold Separately	HDC396450
TRX Series — Groove height = .396"					
Description	Collation	Pack Type	Pieces per Pack	Included	Item Code
MANTIS TRX Clips w/Screws (50 ft ²)	Loose Screws	Box	90	Includes 5 Starter & 5 Finish Clips	HDLTRX90
MANTIS TRX Clips w/Screws (250 ft ²)	Loose Screws	Bucket	450	Starter & Finish Clips Sold Separately	HDLTRX450
MANTIS TRX Clips w/Fasteners (50 ft ²)	Collated Fasteners	Box	90	Includes 5 Starter & 5 Finish Clips	HDCTRX90
MANTIS TRX Clips w/Fasteners (250 ft ²)	Collated Fasteners	Bucket	450	Starter & Finish Clips Sold Separately	HDCTRX450
Tools & Accessories					
Description	Collation	Pack Type	Pieces per Pack	Included	Item Code
SHD150XP — Pneumatic Installation Tool	—	—	—	—	9D0001N
SG2510 — Loose Screwdriver	—	—	—	—	6X0002N
MANTIS 385 Starter Clips w/Screws	—	Clamshell	25	Includes Screws	HDSC38525
MANTIS 396 Starter Clips w/Screws	—	Clamshell	25	Includes Screws	HDSC39625
MANTIS TRX Starter Clips w/Screws	—	Clamshell	25	Includes Screws	HDSCTRX25
MANTIS Finish Clips w/Screws	—	Clamshell	25	Includes Screws	HDFC25

Installation Tips

It's easy with either loose screws or collated reversible fasteners and the SHD150XP tool. Detailed instructions are included in every pack of Senco Mantis Hidden Deck Clips.



STARTER CLIP

Line up the back of the Starter Clip. Fasten this clip to the ledger board with the screws supplied. Slide the deck board groove into the Starter Clip tab.



DECK CLIP

Slide the Mantis Clip into the deck board groove. Fasten to the joist using the supplied fasteners.



FINISH CLIP

FLUSH FINISH: Fasten the Finish Clip leg with one hole to the underside of the deck board. Align the deck board edge with the inside of the Finishing Clip leg with two holes, fasten to the rim joist.

OVERHANG FINISH: Fasten the Finish Clip leg with one hole into the underside of the deck board. Fasten the leg with two holes to the rim joist, pulling the deck board tight into the Deck Clip.



BUTT JOINT

For butt joints that are continuous to the length of the joist, a second joist is required. If the butt joint is random, you can secure a second piece of joist (approximately 18" in length) to the joint area.

CORDLESS PNEUMATIC PERFORMANCE. TRIM ALL DAY.

Experience award-winning cordless convenience in an all-day, everyday trim tool. Available in 15, 16 and 18 gauge, Fusion tools from SENCO feature a revolutionary cordless air-power technology.

- Instant shot with no ramp-up time
- No hose, compressor or fuel cell
- Drives like a pneumatic
- For professional finish and trim

In a recent industry-wide test, the Fusion F-15 was named the top cordless nail gun, highlighting its rapid rate of fire, consistent nail-driving performance in any material and its lightweight, slim-handle design.

APPLICATIONS

Finish and trim, fine woodworking, cabinet, furniture, decorative trim

FEATURES

- Rugged aluminum magazine
- Selectable drive switch allows for contact or sequential trigger actuation
- Nose-mounted LED light
- Adjustable belt hook
- Thumbwheel depth-of-drive
- EZ-Clear feature for quickly clearing jams
- Includes storage bag and charger



F-18

2 1/8" CORDLESS STRAIGHT BRAD NAILER

ITEM #6E0001N



18^{GA}

Features

- Thumbwheel depth-of-drive
- Nose-mounted LED light
- Rapid-charge battery reaches 80% in just 15 minutes

F-16S

2 1/2" CORDLESS STRAIGHT FINISH NAILER

ITEM #6U0001N



16^{GA}

Features

- Thumbwheel depth-of-drive
- Nose-mounted LED light
- Rapid-charge battery reaches 80% in just 15 minutes

F-16A

2 1/2" CORDLESS ANGLED FINISH NAILER

ITEM #5P0001N



16^{GA}
20°

Features

- Thumbwheel depth-of-drive
- Nose-mounted LED light
- Rapid-charge battery reaches 80% in just 15 minutes

F-15

2 1/2" CORDLESS ANGLED FINISH NAILER

ITEM #5N0001N



15^{GA}
34°

Features

- Thumbwheel depth-of-drive
- Nose-mounted LED light
- Rapid-charge battery reaches 80% in just 15 minutes

One Common Battery Platform

SENCO'S 18-Volt Li-Ion Battery System

Designed for long running times with quick recharges, the battery operates at full speed until depleted, so there is no gradual drop in power during use. Special LED fuel gauge displays battery life at the touch of a button.

18V Li-Ion Battery 1.5 amp hour	Fits
VB0155	F-18 F-16S / F-16A F-15
18V Li-Ion Battery 3.0 amp hour	Fits
VB0161	F-18 F-16S / F-16A F-15
Battery Charger	For use with
VB0156	VB0155 VB0161 VB0118



SENCO's 18-Volt Li-Ion batteries work for all Fusion Finish Nailers and all Cordless Duraspin Auto-Feed Screw Systems. See the complete SENCO Battery Platform in the accessories section on page 80.

Works with DS215-18V, DS212-18V and DS312-18V models.

Product Reference Chart

TOOL SPECS	F-18	F-16S	F-16A	F-15
Weight	6 lbs (2.72 kg)	6 lbs (2.72 kg)	6.2 lbs (2.81 kg)	6.2 lbs (2.81 kg)
Height	13" (330 mm)	13" (330 mm)	13" (330 mm)	13" (330 mm)
Length	11" (276 mm)	11" (276 mm)	13" (330 mm)	13" (330 mm)
Width	3" (76 mm)	3" (76 mm)	3" (76 mm)	3" (76 mm)
Charger	80% in 15 minutes, 100% in 45 minutes.			
Warranty	2 yrs	2 yrs	2 yrs	2 yrs
FASTENER SPECS	Fasteners are located on pages 22-23			
Gauge	18	16	16	15
Range	5/8" - 2 1/8"	3/4" - 2 1/2"	1 1/4" - 2 1/2"	1 3/4" - 2 1/2"
Capacity	110	110	110	110
Angle/Collation	Straight Glued Strip	Straight Glued Strip	20° Angled Glued Strip	34° Angled Taped Strip
Series	AY, AX	MO	RH	DA
TOOL FEATURES				
Patented Instant Shot Design	Yes	Yes	Yes	Yes
Depth-of-Drive	Yes, Tool-Free	Yes, Tool-Free	Yes, Tool-Free	Yes, Tool-Free
EZ-Clear Jam Clearing	Yes	Yes	Yes	Yes
Trigger Actuation	Sequential or Contact	Sequential or Contact	Sequential or Contact	Sequential or Contact
Aluminum Drive Cylinder	Yes	Yes	Yes	Yes
Belt Hook	Adjustable and Reversible	Adjustable and Reversible	Adjustable and Reversible	Adjustable and Reversible

18^{GA} Slight Head Brad Nails

Cabinets, decorative trim, picture frames and molding

Length	Point	Head	Finish	Coating	Collation	Box Count	Item Code
5/8"	Chisel	Slight	Galv	Plain	Straight Glued Strip	5M	AY10EAA
3/4"	Chisel	Slight	Galv	Plain	Straight Glued Strip	5M	AY11EAA
1"	Chisel	Slight	Galv	Plain	Straight Glued Strip	5M	AY13EAA

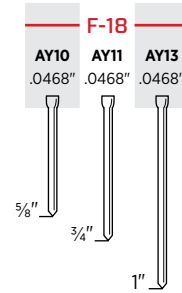

18^{GA} Straight Strip Brad Nails

Cabinets, decorative trim, picture frames and molding

Length	Point	Head	Finish	Coating	Collation	Box Count	Item Code
5/8"	Chisel	Medium	Galv	Plain	Straight Glued Strip	5M	AX10EAA
3/4"	Chisel	Medium	Galv	Plain	Straight Glued Strip	5M	AX11EAA
1"	Chisel	Medium	Galv	Plain	Straight Glued Strip	5M	AX13EAA
1 1/4"	Chisel	Medium	Galv	Plain	Straight Glued Strip	5M	AX15EAA
1 1/2"	Chisel	Medium	Galv	Plain	Straight Glued Strip	5M	AX17EAA
1 5/8"	Chisel	Medium	Galv	Plain	Straight Glued Strip	5M	AX18EAA
1 3/4"	Chisel	Medium	Galv	Plain	Straight Glued Strip	5M	AX19EAA
2"	Chisel	Medium	Galv	Plain	Straight Glued Strip	5M	AX21EAA
2 1/8"	Chisel	Medium	Galv	Plain	Straight Glued Strip	5M	AX22EAA
1"	Chisel	Medium	Galv	Plain	Straight Glued Strip	1M (CS)	A201009
1 1/4"	Chisel	Medium	Galv	Plain	Straight Glued Strip	1M (CS)	A201259
1 1/2"	Chisel	Medium	Galv	Plain	Straight Glued Strip	0.8M (CS)	A201509
2"	Chisel	Medium	Galv	Plain	Straight Glued Strip	0.8M (CS)	A202009
5/8-1 1/4"	Chisel	Medium	Galv	Plain	Straight Glued Strip	1.2M (CS)	A209809*
1-2"	Chisel	Medium	Galv	Plain	Straight Glued Strip	1.2M (CS)	A209909*
1"	Chisel	Medium	Stainless 304	Plain	Straight Glued Strip	1M (CS)	AX13EGAR
1 1/4"	Chisel	Medium	Stainless 304	Plain	Straight Glued Strip	1M (CS)	AX15EGAR
1 1/2"	Chisel	Medium	Stainless 304	Plain	Straight Glued Strip	1M (CS)	AX17EGAR
2"	Chisel	Medium	Stainless 304	Plain	Straight Glued Strip	1M (CS)	AX21EGAR

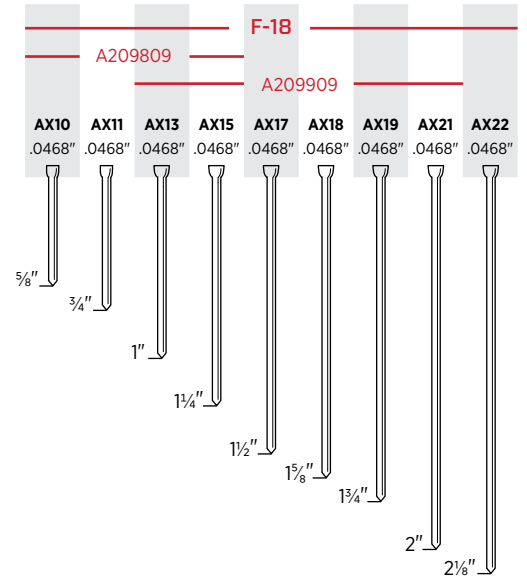

CS-Clamshell, *Variety Pack

16^{GA} Straight Strip Finish Nails

Furniture and cabinets, molding and trim, baseboard, chair rails, window casings and upholstery trim panels

Length	Point	Head	Finish	Coating	Collation	Box Count	Item Code
3/4"	Chisel	T-head	Galv	Plain	Straight Glued Strip	2M	M001000
1"	Chisel	T-head	Galv	Plain	Straight Glued Strip	2M (PT)	M001001
1 1/4"	Chisel	T-head	Galv	Plain	Straight Glued Strip	2M (PT)	M001002
1 1/2"	Chisel	T-head	Galv	Plain	Straight Glued Strip	2M (PT)	M001003
1 3/4"	Chisel	T-head	Galv	Plain	Straight Glued Strip	2M (PT)	M001004
2"	Chisel	T-head	Galv	Plain	Straight Glued Strip	2M (PT)	M001005
2 1/2"	Chisel	T-head	Galv	Plain	Straight Glued Strip	2M (PT)	M001007
1"	Chisel	T-head	Galv	Plain	Straight Glued Strip	1.2M (CS)	A401009
1 1/4"	Chisel	T-head	Galv	Plain	Straight Glued Strip	1.2M (CS)	A401259
1 1/2"	Chisel	T-head	Galv	Plain	Straight Glued Strip	0.7M (CS)	A401509
1 3/4"	Chisel	T-head	Galv	Plain	Straight Glued Strip	0.7M (CS)	A401759
2"	Chisel	T-head	Galv	Plain	Straight Glued Strip	0.7M (CS)	A402009
2 1/2"	Chisel	T-head	Galv	Plain	Straight Glued Strip	0.7M (CS)	A402509
1 1/4"-2 1/2"	Chisel	T-head	Galv	Plain	Straight Glued Strip	0.8M (CS)	A409809*
1 1/2"	Chisel	T-head	Stainless 304	Plain	Straight Glued Strip	0.7M	M001003GR
2"	Chisel	T-head	Stainless 304	Plain	Straight Glued Strip	0.7M	M001005GR
2 1/2"	Chisel	T-head	Stainless 304	Plain	Straight Glued Strip	0.7M	M001007GR

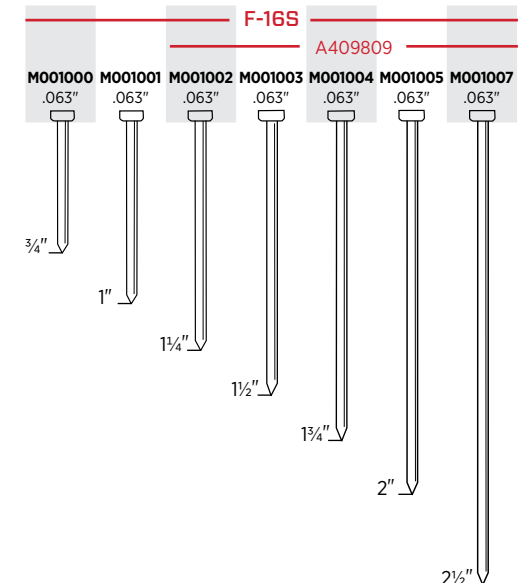

CS-Clamshell, PT-Plastic Tub, *Variety Pack

FUSION FASTENERS

16^{GA}
20°

Angled Strip Finish Nails*

Furniture and cabinets, molding and trim, baseboard, chair rails, window casings and upholstery trim panels

Length	Point	Head	Finish	Coating	Collation	Box Count	Item Code
1¼"	Chisel	T-head	Galv	Plain	20° Angled Glued Strip	2M (PT)	RH15EAA
1½"	Chisel	T-head	Galv	Plain	20° Angled Glued Strip	2M (PT)	RH17EAA
1¾"	Chisel	T-head	Galv	Plain	20° Angled Glued Strip	2M (PT)	RH19EAA
2"	Chisel	T-head	Galv	Plain	20° Angled Glued Strip	2M (PT)	RH21EAA
2½"	Chisel	T-head	Galv	Plain	20° Angled Glued Strip	2M (PT)	RH25EAA

PT-Plastic Tub

*NOTE: only fits 16 gauge, 20° finish nailers

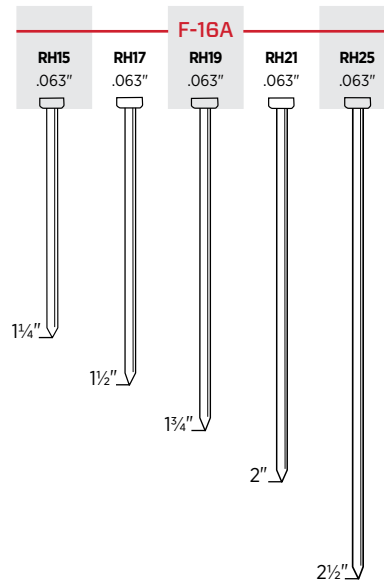

15^{GA}
34°

Angled Strip Finish Nails

Furniture and cabinets, molding and trim, baseboard, chair rails, doors and window casings

Length	Point	Head	Finish	Coating	Collation	Box Count	Item Code
1"	Chisel	Brad	Bright	Sencote	34° Angled Taped Strip	4M	DA13EPBN
1¼"	Chisel	Brad	Bright	Sencote	34° Angled Taped Strip	4M	DA15EPBN
1½"	Chisel	Brad	Bright	Sencote	34° Angled Taped Strip	4M	DA17EPBN
1¾"	Chisel	Brad	Bright	Sencote	34° Angled Taped Strip	4M	DA19EPBN
2"	Chisel	Brad	Bright	Sencote	34° Angled Taped Strip	4M	DA21EPBN
2¼"	Chisel	Brad	Bright	Sencote	34° Angled Taped Strip	4M	DA23EPBN
2½"	Chisel	Brad	Bright	Sencote	34° Angled Taped Strip	3M	DA25EPB
1½"	Chisel	Brad	Bright	Sencote	34° Angled Taped Strip	0.7M (CS)	A301500
1¾"	Chisel	Brad	Bright	Sencote	34° Angled Taped Strip	0.7M (CS)	A301750
2"	Chisel	Brad	Bright	Sencote	34° Angled Taped Strip	0.7M (CS)	A302000
2½"	Chisel	Brad	Bright	Sencote	34° Angled Taped Strip	0.7M (CS)	A302500
1¼"	Chisel	Brad	Galv	Sencote	34° Angled Taped Strip	4M	DA15EABN
1½"	Chisel	Brad	Galv	Sencote	34° Angled Taped Strip	4M	DA17EABN
1¾"	Chisel	Brad	Galv	Sencote	34° Angled Taped Strip	4M	DA19EABN
2"	Chisel	Brad	Galv	Sencote	34° Angled Taped Strip	4M	DA21EABN
2½"	Chisel	Brad	Galv	Sencote	34° Angled Taped Strip	3M	DA25EAB
2"	Chisel	Brad	Galv	Sencote	34° Angled Taped Strip	0.7M (CS)	A302009
2½"	Chisel	Brad	Galv	Sencote	34° Angled Taped Strip	0.7M (CS)	A302509
2"	Chisel	Brad	Stainless 304	Sencote	34° Angled Taped Strip	2M	DA21EGBN
2½"	Chisel	Brad	Stainless 304	Sencote	34° Angled Taped Strip	1.2M	DA25EGB
1¼"	Diamond	Brad	Hardened*	Plain	34° Angled Taped Strip	4M	DA15AIA
1½"	Diamond	Brad	Hardened*	Plain	34° Angled Taped Strip	4M	DA17AIA
1¾"	Diamond	Brad	Hardened*	Plain	34° Angled Taped Strip	4M	DA19AIA

CS-Clamshell

*Hardened regular galvanized heat treated 15 gauge for steel stud and trim applications

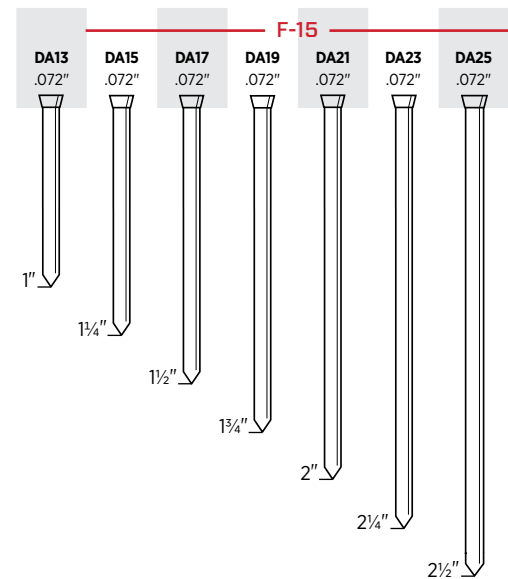

Maximize Your Fusion Cordless Convenience.

SENCO® manufactures 62 varieties of finish nails available in 6 gauges and 12 lengths.



FINISH & WOODWORKING

THE DIFFERENCE IS IN THE DETAILS

SENCO has set the industry standard for finish and fine woodworking tools, providing compact, ultra-light, easy-to-use tools designed for precision and longevity.

We offer a broader range of tools than anyone else, covering 15–23 gauge nailers and 15–18 gauge staplers, including the award-winning 21 gauge FinishPro®21LXP.

APPLICATIONS

Cabinetry, furniture, decorative trim, crown molding, custom woodworking applications and all other finish needs

FEATURES

- EZ-Clear™ latch to clear jams fast
- No-mar pads to protect woodwork
- Clear line-of-sight for precision fastening
- Comfort grip
- Adjustable depth-of-drive



FinishPro® 23SXP

1 3/8" HEADLESS PINNER

ITEM #8F0001N



23^{GA}

Features

- Powerful — ensures complete drives into hard substrates
- Automatically adjusts for different fastener lengths
- Ergonomic handle for all-day comfort
- Ultra-narrow nose for tight corners
- Includes case, swivel air plug, wrench and tool oil

FinishPro® 23LXP

2" HEADLESS PINNER

ITEM #8L0001N



23^{GA}

Features

- Most powerful tool in its class — ensures complete drives into hard substrates
- Automatically adjusts for different fastener lengths
- Ergonomic handle for all-day comfort
- Ultra-narrow nose for tight corners
- Includes case, swivel air plug, wrench and tool oil

Pins and Brads: 23, 21 & 18 Gauge the new standard when details matter



Product Reference Chart

TOOL SPECS	FinishPro®23SXP	FinishPro®23LXP
Trigger	Sequential	Sequential
Operating Pressure	70-100 psi (4.8-7 bar)	70-110 psi (4.8-7.6 bar)
Air Consumption (60 CPM)	1.1 scfm	1.1 scfm
Air Inlet	1/4" NPT	1/4" NPT
Weight	2.5 lbs (1.1 kg)	2.7 lbs (1.2 kg)
Height	7.56" (192 mm)	8.89" (226 mm)
Length	7.87" (200 mm)	7.87" (200 mm)
Width	1.85" (44 mm)	1.85" (44 mm)
Main Body Material	Aluminum	Aluminum
Warranty	5 yrs	5 yrs
FASTENER SPECS	Fasteners are located on pages 32-37	
Gauge	23	23
Range	1/2"-1 3/8"	1/2"-2"
Capacity	126	126
Angle/Collation	Straight Glued Strip	Straight Glued Strip
Series	A10, CZ	A10, CZ
TOOL FEATURES		
Depth-of-Drive	No	No
Belt Hook	Yes	Yes
Oil-Less	No	No
Exhaust	Rear	Rear

FinishPro®21LXP

2" PINNER

ITEM #8M0001N



21_{GA}

Features

- Powerful — ensures complete drives into hard substrates
- Automatically adjusts for different fastener lengths
- Ergonomic handle for all-day comfort
- Ultra-narrow nose for tight corners
- Includes case, swivel air plug, wrench and tool oil

LS1XP

1" HEADLESS BRAD NAILER

ITEM #8N0001N



18_{GA}

Features

- Never-Lube® design — no lubrication to stain fine woods
- Ergonomic handle for all-day comfort
- Narrow nose for tight corners

FinishPro®18Mg

2½" BRAD NAILER

ITEM #1U0021N



18_{GA}

Features

- Metal cylinder for increased durability
- EZ-Clear™ latch virtually eliminates downtime caused by fastener jams
- Narrow nose for tight corners
- Includes case, swivel air plug and wrench

FinishPro®18BMg

2½" BRAD NAILER

ITEM #9B0001N



18_{GA}

Features

- Oil-free design — no oil required
- Ultra-lightweight for ease of use and maneuverability
- Nose mounted LED light illuminates dark work spaces
- Includes case, swivel air plug and wrench

Product Reference Chart

TOOL SPECS	FinishPro®21LXP	LS1XP	FinishPro®18Mg	FinishPro®18BMg
Trigger	Sequential	Sequential	Selectable	Selectable
Operating Pressure	70-110 psi (4.8-7.6 bar)	70-120 psi (4.8-8.3 bar)	70-120 psi (4.8-8.3 bar)	70-120 psi (4.8-8.3 bar)
Air Consumption (60 CPM)	1.1 scfm	1.92 scfm	2.4 scfm	1.6 scfm
Air Inlet	¼" NPT	¼" NPT	¼" NPT	¼" NPT
Weight	3.15 lbs (1.43 kg)	2.9 lbs (1.3 kg)	2.48 lbs (1.12 kg)	2.8 lbs (1.26 kg)
Height	8.89" (226 mm)	8.25" (210 mm)	9.75" (248 mm)	9.8" (248 mm)
Length	7.87" (200 mm)	9" (229 mm)	10.5" (267 mm)	10" (255 mm)
Width	1.85" (44 mm)	2" (51 mm)	2.5" (63.5 mm)	2.5" (63.5 mm)
Main Body Material	Aluminum	Aluminum	Magnesium	Magnesium
Warranty	5 yrs	5 yrs	5 yrs	5 yrs
FASTENER SPECS	Fasteners are located on pages 32-37			
Gauge	21	18	18	18
Range	⅝" - 2"	½" - 1"	⅝" - 2½"	⅝" - 2½"
Capacity	170	100	110	100
Angle/Collation	Straight Glued Strip	Straight Glued Strip	Straight Glued Strip	Straight Glued Strip
Series	ZX	AZ	AX	AX
TOOL FEATURES				
Depth-of-Drive	No	No	Yes, Tool-Free	Yes, Tool-Free
Belt Hook	Yes	Fixed	Yes	Yes
Oil-Less	No	Yes	Yes	Yes
Exhaust	Rear	Fixed	Rear Adjustable	Rear Adjustable

SLP20XP

1½" BRAD NAILER

ITEM #430101N



18_{GA}

Features

- Never-Lube® design — no oil required
- Drives both slight and medium headed brads
- Muffler ensures quieter operation
- Includes case

FinishPro®25XP

2½" BRAD NAILER

ITEM #760102N



18_{GA}

Features

- Never-Lube® design — no oil required
- Drives both slight and medium headed brads
- Powerful — ensures complete drives into hard substrates
- Includes case

Product Reference Chart

TOOL SPECS	SLP20XP	FinishPro®25XP
Trigger	Sequential	Sequential
Operating Pressure	70-120 psi (4.8-8.3 bar)	70-120 psi (4.8-8.3 bar)
Air Consumption (60 CPM)	1.92 scfm	1.92 scfm
Air Inlet	¼" NPT	¼" NPT
Weight	2.3 lbs (1 kg)	2.7 lbs (1.2 kg)
Height	8.25" (210 mm)	9.9" (251 mm)
Length	9.5" (241 mm)	9.8" (249 mm)
Width	2" (50.8 mm)	2.2" (56 mm)
Main Body Material	Aluminum	Aluminum
Warranty	5 yrs	5 yrs
FASTENER SPECS	Fasteners are located on pages 32-37	
Gauge	18	18
Range	⅝" - 1⅝"	⅝" - 2⅛"
Capacity	110	110
Angle/Collation	Straight Glued Strip	Straight Glued Strip
Series	AX, AY	AX, AY
TOOL FEATURES		
Depth-of-Drive	No	Yes, Tool-Free
Belt Hook	No	Yes
Oil-Less	Yes	Yes
Exhaust	Fixed	Adjustable

FinishPro®32

2½" FINISH NAILER

ITEM #1X0201N



16^{GA}

Features

- EZ-Clear™ latch virtually eliminates downtime caused by fastener jams
- Piston and driver designed for durability
- Reversed safety element for improved line of sight
- Includes case

FinishPro®33Mg

2½" ANGLED FINISH NAILER

ITEM #6F0001N



16^{GA}
20°

Features

- EZ-Clear™ latch virtually eliminates downtime caused by fastener jams
- Integrated air blower clears debris from work surface
- Metal cylinder for increased durability
- Includes case, swivel air plug and wrench

SFN30

2" ANGLED FINISH NAILER

ITEM #620002N



15^{GA}
34°

Features

- Never-Lube® design — no oil required
- EZ-Clear™ latch virtually eliminates downtime caused by fastener jams
- Ultra-lightweight for ease of use and maneuverability
- Includes case

Product Reference Chart

TOOL SPECS	FinishPro®32	FinishPro®33Mg	SFN30
Trigger	Sequential	Selectable	Sequential
Operating Pressure	70–120 psi (4.8–8.3 bar)	70–120 psi (4.8–8.3 bar)	70–120 psi (4.8–8.3 bar)
Air Consumption (60 CPM)	2.16 scfm	2.22 scfm	2.16 scfm
Air Inlet	¼" NPT	¼" NPT	¼" NPT
Weight	4.2 lbs (1.9 kg)	3.83 lbs (1.74 kg)	3.6 lbs (1.6 kg)
Height	10.88" (276 mm)	11.5" (292 mm)	9.62" (244 mm)
Length	12.16" (307 mm)	12" (305 mm)	12" (305 mm)
Width	3" (76 mm)	3" (76 mm)	3.25" (82.5 mm)
Main Body Material	Aluminum	Magnesium	Composite
Warranty	5 yrs	5 yrs	5 yrs
FASTENER SPECS	Fasteners are located on pages 32–37		
Gauge	16	16	15
Range	1¼"–2½"	1¼"–2½"	1"–2"
Capacity	110	110	104
Angle/Collation	Straight Glued Strip	20° Angled Strip	34° Angled Tape Strip
Series	A4, MO	RH	DA
TOOL FEATURES			
Depth-of-Drive	Yes, Tool-Free	Yes, Tool-Free	Yes, Tool-Free
Belt Hook	Yes	Yes	Yes
Oil-Less	No	Yes	Yes
Exhaust	Adjustable	Adjustable	Fixed

FinishPro® 35Mg

2½" ANGLED FINISH NAILER

ITEM #6G0001N



15^{GA}
34°

Features

- EZ-Clear™ latch virtually eliminates downtime caused by fastener jams
- Integrated air blower clears debris from work surface
- Metal cylinder for increased durability
- Includes case, swivel air plug and wrench

FinishPro® 42XP

2½" ANGLED FINISH NAILER

ITEM #4G0001N



15^{GA}
34°

Features

- Never-Lube® design — no oil required
- EZ-Clear™ latch virtually eliminates downtime caused by fastener jams
- High-strength driver with threaded connection
- Metal cylinder for increased durability
- Includes case, belt hook and contact trigger kit

Product Reference Chart

TOOL SPECS	FinishPro® 35Mg	FinishPro® 42XP
Trigger	Selectable	Sequential
Operating Pressure	70–120 psi (4.8–8.3 bar)	70–120 psi (4.8–8.3 bar)
Air Consumption (60 CPM)	3.2 scfm	3.87 scfm
Air Inlet	¼" NPT	¼" NPT
Weight	4.2 lbs (1.9 kg)	4.7 lbs (2.1 kg)
Height	12.25" (311 mm)	11.25" (286 mm)
Length	13" (330 mm)	13" (330 mm)
Width	3.5" (89 mm)	3.5" (89 mm)
Main Body Material	Magnesium	Magnesium
Warranty	5 yrs	5 yrs
FASTENER SPECS	Fasteners are located on pages 32–37	
Gauge	15	15
Range	1¼"–2½"	1¼"–2½"
Capacity	110	104
Angle/Collation	34° Angled Tape Strip	34° Angled Tape Strip
Series	DA	DA
TOOL FEATURES		
Depth-of-Drive	Yes, Tool-Free	Yes, Tool-Free
Belt Hook	Yes	Yes
Oil-Less	Yes	Yes
Exhaust	Adjustable	Adjustable

SLS20XP

3/16", 1/4", 3/8" CROWNS, 1/2" FINE/MEDIUM WIRE STAPLER

SEE ITEM # CHART

19_{GA} 18_{GA}



Features

- Never-Lube® design — no oil required
- Ultra-lightweight for ease of use and maneuverability
- Metal cylinder for increased durability
- Muffler ensures quieter operation

SLS25XP

1/4", 3/8" CROWNS, 1/2" MEDIUM WIRE STAPLER

SEE ITEM # CHART

18_{GA}



Features

- Never-Lube® design — no oil required
- Ultra-lightweight for ease of use and maneuverability
- Metal cylinder for increased durability
- Muffler ensures quieter operation

SKSXP

1/4", 3/8", 7/16" CROWNS, 1/2" MEDIUM/HEAVY WIRE STAPLER

SEE ITEM # CHART

18_{GA} 16_{GA}



Features

- Never-Lube® design — no oil required
- EZ-Clear™ latch virtually eliminates downtime caused by fastener jams
- Long 1" lip to get into tight spots

SLS20XP, SLS25XP and SKSXP ITEM # Chart

Model	Item Code
SLS20XP-K	490101N
SLS20XP-L	490103N
SLS20XP-L W/CASE	490105N
SLS20XP-L SENCOMATIC	490015N
SLS20XP-M SENCOMATIC	490009N
SLS20XP-M	490107N
SLS20XP-R	490111N
SLS25XP-L	820103N
SLS25XP-M	820107N
SKSXP-L	300120N
SKSXP-M	300152N
SKSXP-N	300184N

Product Reference Chart

TOOL SPECS	SLS20XP	SLS25XP	SKSXP
Trigger	Sequential	Contact	Sequential
Operating Pressure	70-120 psi (4.8-8.3 bar)	70-120 psi (4.8-8.3 bar)	70-120 psi (4.8-8.3 bar)
Air Consumption (60 CPM)	1.92 scfm	1.92 scfm	2.16 scfm
Air Inlet	1/4" NPT	1/4" NPT	1/4" NPT
Weight	2.5 lbs (1.13 kg)	2.67 lbs (1.21 kg)	4.2 lbs (1.9 kg)
Height	8.5" (216 mm)	9" (229 mm)	9.25" (238 mm)
Length	12" (305 mm)	12" (305 mm)	12.38" (314 mm)
Width	2" (50.8 mm)	2" (50.8 mm)	3" (76 mm)
Main Body Material	Aluminum	Aluminum	Aluminum
Warranty	5 yrs	5 yrs	5 yrs
FASTENER SPECS	Fasteners are located on pages 32-37		
Gauge	19, 18	18	18, 16
Crown	3/16", 1/4", 3/8"	1/4", 3/8"	1/4", 3/8", 7/16"
Range	3/8"-1 1/2"	3/8"-1 1/2"	3/4"-1 1/2"
Capacity	168	168	145
Angle/Collation	Straight Glued Strip	Straight Glued Strip	Straight Glued Strip
Series	K, L, M, R	L, M	L, M, N
TOOL FEATURES			
Depth-of-Drive	Yes	Yes	No
Belt Hook	No	No	No
Oil-Less	Yes	Yes	Yes

SLS150Mg

1/4" CROWN, 1/16" MEDIUM WIRE STAPLER

ITEM #8C0001N

18_{GA}



Features

- Ultra-lightweight for ease of use and maneuverability
- Nose-mounted LED light — illuminates work surface
- Durable composite magazine
- Reload indicator on magazine
- Includes case and wrench

SLS18Mg

1/4" CROWN, 1 1/2" MEDIUM WIRE STAPLER

ITEM #1W0021N

18_{GA}



Features

- Ultra-lightweight for ease of use and maneuverability
- Metal cylinder for increased durability
- Reload indicator on magazine
- Includes case, swivel air plug and wrench

SC1XP Senclamp®

7/16" CROWN, 9/16" SENCLAMP® FASTENER

ITEM #220101N, CYCLE-THRU MODEL ITEM #4E0002N

25_{GA}



Features

- Senclamp® fasteners pull the joint together during driving for a tight, permanent fit
- Eliminates milling, doweling, clamping, screwing and other time-consuming, cost-adding operations
- The Senclamp high-carbon steel fastener derives added strength from its special webbed design

SC2 Sencor®

1" CROWN, 1/2" CORRUGATED STAPLER

ITEM #470001N

25_{GA}



Features

- Powerful — ensures complete drives into hard substrates
- Eliminates gluing, milling, doweling, screwing and clamping
- Added strength for larger butt joints

Product Reference Chart

TOOL SPECS	SLS150Mg	SLS18Mg	SC1XP Senclamp®	SC2 Sencor®
Trigger	Selectable	Selectable	Sequential	Sequential
Operating Pressure	70-120 psi (4.8-8.3 bar)	70-120 psi (4.8-8.3 bar)	80-110 psi (5.5-7.5 bar)	80-110 psi (5.5-7.5 bar)
Air Consumption (60 CPM)	2.4 scfm	2.4 scfm	3.8 scfm	3.7 scfm
Air Inlet	1/4" NPT	1/4" NPT	3/8" NPT	3/8" NPT
Weight	2.6 lbs (1.8 kg)	2.6 lbs (1.8 kg)	6.3 lbs (2.8 kg)	6.9 lbs (3.1 kg)
Height	9.5" (241 mm)	9.5" (241 mm)	9.8" (249 mm)	9.44" (240 mm)
Length	10.25" (260 mm)	10.25" (260 mm)	12.7" (322 mm)	12.5" (318 mm)
Width	2.5" (63.5 mm)	2.5" (63.5 mm)	2.5" (63.5 mm)	2" (50.8 mm)
Main Body Material	Magnesium	Magnesium	Aluminum	Aluminum
Warranty	5 yrs	5 yrs	5 yrs	5 yrs
FASTENER SPECS	Fasteners are located on pages 32-37			
Gauge	18	18	25	25
Crown	1/4"	1/4"	7/16"	1"
Range	1/2"-1 9/16"	3/8"-1 1/2"	5/16"-9/16"	1/4"-1/2"
Capacity	110	110	120	80
Angle/Collation	Straight Glued & Taped Strip	Straight Glued & Taped Strip	Straight Glued & Taped Strip	Straight Glued Strip
Series	L	L	Y	X
TOOL FEATURES				
Depth-of-Drive	Yes, Tool-Free	Yes, Tool-Free	No	No
Belt Hook	Yes	Yes	No	No
Oil-Less	Yes	Yes	No	No

23^{GA}

Headless Straight Strip Pins

Pins fasten the smallest of trim securely leaving a nearly invisible hole

Length	Point	Head	Finish	Coating	Collation	Box Count	Item Code
½"	Chisel	Headless	Galv	Plain	Straight Glued Strip	15.5M	CZ08EAAN
⅝"	Chisel	Headless	Galv	Plain	Straight Glued Strip	15.5M	CZ10EAAN
¾"	Chisel	Headless	Galv	Plain	Straight Glued Strip	15.5M	CZ11EAAN
½"	Chisel	Headless	Galv	Plain	Straight Glued Strip	2.6M (CS)	A100509
⅝"	Chisel	Headless	Galv	Plain	Straight Glued Strip	2.6M (CS)	A100629
¾"	Chisel	Headless	Galv	Plain	Straight Glued Strip	2.6M (CS)	A100759
1"	Chisel	Headless	Galv	Plain	Straight Glued Strip	2.6M (CS)	A101009
1¼"	Chisel	Headless	Galv	Plain	Straight Glued Strip	2.6M (CS)	A101259
1⅜"	Chisel	Headless	Galv	Plain	Straight Glued Strip	2.6M (CS)	A101379
1½"	Chisel	Headless	Galv	Plain	Straight Glued Strip	2.6M (CS)	A101509
2"	Chisel	Headless	Galv	Plain	Straight Glued Strip	2.6M (CS)	A102009
½"-1"	Chisel	Headless	Galv	Plain	Straight Glued Strip	2.5M (CS)	A109809*
1"-2"	Chisel	Headless	Galv	Plain	Straight Glued Strip	2.5M (CS)	A109909*

CS-Clamshell, *Variety Pack

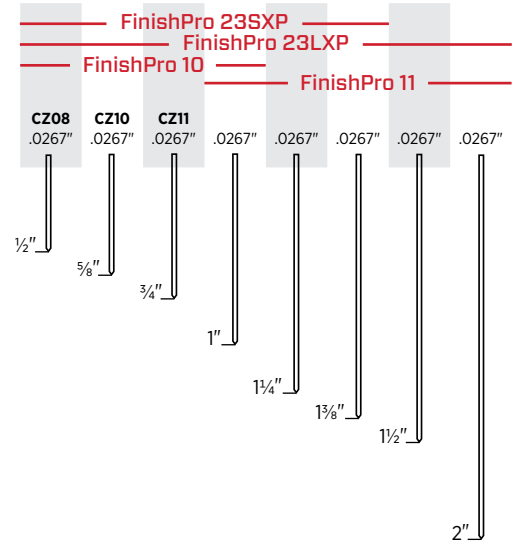

21^{GA}

Medium Straight Strip Head Pins

21 gauge pins offer significantly more holding power than 23 gauge pins while leaving a much smaller indent than an 18 gauge brad

Length	Point	Head	Finish	Coating	Collation	Box Count	Item Code
⅝"	Chisel	Medium	Galv	Plain	Straight Glued Strip	5M	ZX10EAA
1"	Chisel	Medium	Galv	Plain	Straight Glued Strip	5M	ZX13EAA
1⅜"	Chisel	Medium	Galv	Plain	Straight Glued Strip	5M	ZX16EAA
1⅝"	Chisel	Medium	Galv	Plain	Straight Glued Strip	5M	ZX18EAA
2"	Chisel	Medium	Galv	Plain	Straight Glued Strip	5M	ZX21EAA
⅝"	Chisel	Medium	Galv	Plain	Straight Glued Strip	1M (CS)	ZX10EAANR
1"	Chisel	Medium	Galv	Plain	Straight Glued Strip	1M (CS)	ZX13EAANR
1⅜"	Chisel	Medium	Galv	Plain	Straight Glued Strip	1M (CS)	ZX16EAANR
1⅝"	Chisel	Medium	Galv	Plain	Straight Glued Strip	0.8M (CS)	ZX18EAANR
2"	Chisel	Medium	Galv	Plain	Straight Glued Strip	0.8M (CS)	ZX21EAANR

CS-Clamshell

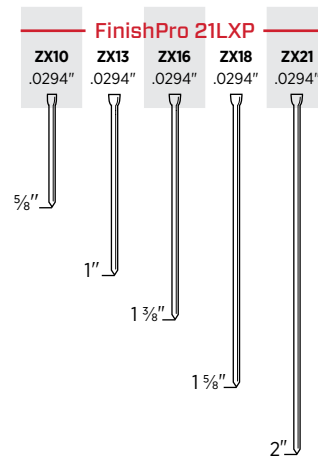

18^{GA}

Straight Strip Brad Nails

Cabinets, decorative trim, picture frames and molding

Length	Point	Head	Finish	Coating	Collation	Box Count	Item Code
⅝"	Chisel	Medium	Galv	Plain	Straight Glued Strip	5M	AX10EAA
¾"	Chisel	Medium	Galv	Plain	Straight Glued Strip	5M	AX11EAA
1"	Chisel	Medium	Galv	Plain	Straight Glued Strip	5M	AX13EAA
1¼"	Chisel	Medium	Galv	Plain	Straight Glued Strip	5M	AX15EAA
1½"	Chisel	Medium	Galv	Plain	Straight Glued Strip	5M	AX17EAA
1⅝"	Chisel	Medium	Galv	Plain	Straight Glued Strip	5M	AX18EAA
1¾"	Chisel	Medium	Galv	Plain	Straight Glued Strip	5M	AX19EAA
2"	Chisel	Medium	Galv	Plain	Straight Glued Strip	5M	AX21EAAN
2½"	Chisel	Medium	Galv	Plain	Straight Glued Strip	5M	AX22EAAN
1"	Chisel	Medium	Galv	Plain	Straight Glued Strip	1M (CS)	A201009
1¼"	Chisel	Medium	Galv	Plain	Straight Glued Strip	1M (CS)	A201259
1½"	Chisel	Medium	Galv	Plain	Straight Glued Strip	0.8M (CS)	A201509
2"	Chisel	Medium	Galv	Plain	Straight Glued Strip	0.8M (CS)	A202009
⅝"-1¾"	Chisel	Medium	Galv	Plain	Straight Glued Strip	1.2M (CS)	A209809*
1-2"	Chisel	Medium	Galv	Plain	Straight Glued Strip	1.2M (CS)	A209909*
1"	Chisel	Medium	Stainless 304	Plain	Straight Glued Strip	1M (CS)	AX13EGAR
1¼"	Chisel	Medium	Stainless 304	Plain	Straight Glued Strip	1M (CS)	AX15EGAR
1½"	Chisel	Medium	Stainless 304	Plain	Straight Glued Strip	1M (CS)	AX17EGAR
2"	Chisel	Medium	Stainless 304	Plain	Straight Glued Strip	1M (CS)	AX21EGAR

CS-Clamshell, *Variety Pack

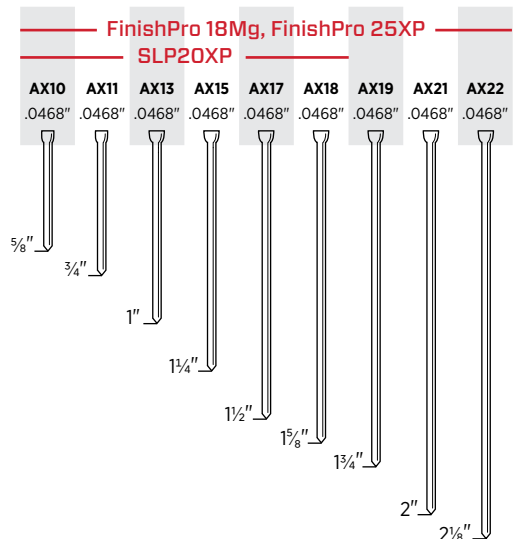

18^{GA}

Headless and Slight Head Brad Nails

Cabinets, decorative trim, picture frames and molding

Length	Point	Head	Finish	Coating	Collation	Box Count	Item Code
½"	Chisel	Headless	Galv	Plain	Straight Glued Strip	5M	AZ08EAA
¾"	Chisel	Headless	Galv	Plain	Straight Glued Strip	5M	AZ11EAA
1"	Chisel	Headless	Galv	Plain	Straight Glued Strip	5M	AZ13EAA
⅝"	Chisel	Slight	Galv	Plain	Straight Glued Strip	5M	AY10EAA
¾"	Chisel	Slight	Galv	Plain	Straight Glued Strip	5M	AY11EAA
1"	Chisel	Slight	Galv	Plain	Straight Glued Strip	5M	AY13EAA

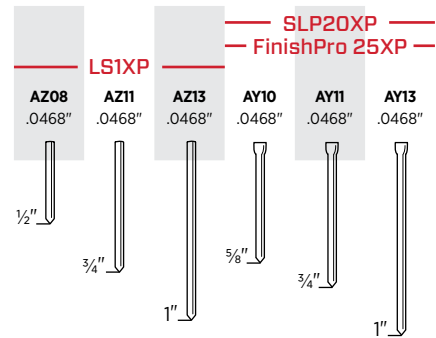

16^{GA}
20°

Angled Strip Finish Nails*

Furniture and cabinets, molding and trim, baseboard, chair rails, window casings and upholstery trim panels

Length	Point	Head	Finish	Coating	Collation	Box Count	Item Code
1¼"	Chisel	T-head	Galv	Plain	20° Angled Glued Strip	2M (PT)	RH15EAA
1½"	Chisel	T-head	Galv	Plain	20° Angled Glued Strip	2M (PT)	RH17EAA
1¾"	Chisel	T-head	Galv	Plain	20° Angled Glued Strip	2M (PT)	RH19EAA
2"	Chisel	T-head	Galv	Plain	20° Angled Glued Strip	2M (PT)	RH21EAA
2½"	Chisel	T-head	Galv	Plain	20° Angled Glued Strip	2M (PT)	RH25EAA

PT-Plastic Tub

*NOTE: ONLY fits 16 Gauge/20° Finish Nailers

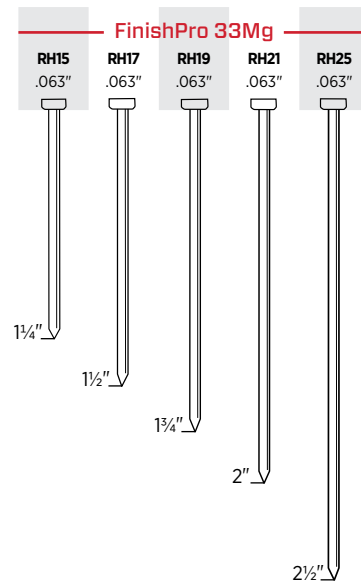

16^{GA}

Straight Strip Finish Nails

Furniture and cabinets, molding and trim, baseboard, chair rails, window casings and upholstery trim panels

Length	Point	Head	Finish	Coating	Collation	Box Count	Item Code
¾"	Chisel	T-head	Galv	Plain	Straight Glued Strip	2M	M001000
1"	Chisel	T-head	Galv	Plain	Straight Glued Strip	2M (PT)	M001001
1¼"	Chisel	T-head	Galv	Plain	Straight Glued Strip	2M (PT)	M001002
1½"	Chisel	T-head	Galv	Plain	Straight Glued Strip	2M (PT)	M001003
1¾"	Chisel	T-head	Galv	Plain	Straight Glued Strip	2M (PT)	M001004
2"	Chisel	T-head	Galv	Plain	Straight Glued Strip	2M (PT)	M001005
2½"	Chisel	T-head	Galv	Plain	Straight Glued Strip	2M (PT)	M001007
1"	Chisel	T-head	Galv	Plain	Straight Glued Strip	1.2M (CS)	A401009
1¼"	Chisel	T-head	Galv	Plain	Straight Glued Strip	1.2M (CS)	A401259
1½"	Chisel	T-head	Galv	Plain	Straight Glued Strip	0.7M (CS)	A401509
1¾"	Chisel	T-head	Galv	Plain	Straight Glued Strip	0.7M (CS)	A401759
2"	Chisel	T-head	Galv	Plain	Straight Glued Strip	0.7M (CS)	A402009
2½"	Chisel	T-head	Galv	Plain	Straight Glued Strip	0.7M (CS)	A402509
1¼"-2½"	Chisel	T-head	Galv	Plain	Straight Glued Strip	0.8M (CS)	A409809*
1½"	Chisel	T-head	Stainless 304	Plain	Straight Glued Strip	0.7M	M001003GR
2"	Chisel	T-head	Stainless 304	Plain	Straight Glued Strip	0.7M	M001005GR
2½"	Chisel	T-head	Stainless 304	Plain	Straight Glued Strip	0.7M	M001007GR

CS-Clamshell, PT-Plastic Tub, *Variety Pack

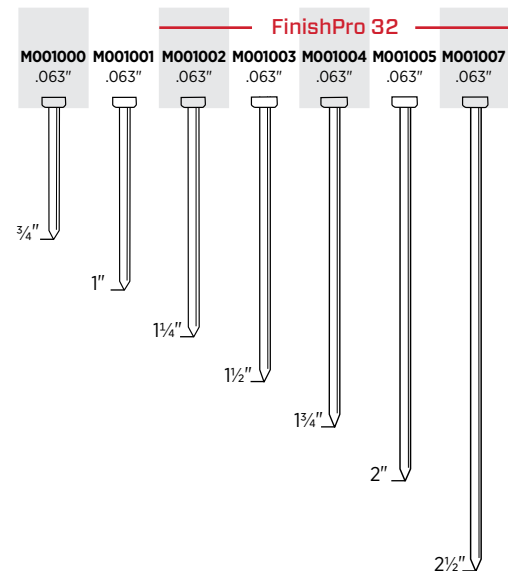

15^{GA}
34°

Angled Strip Finish Nails

Furniture and cabinets, molding and trim, baseboard, chair rails, doors and window casings

Length	Point	Head	Finish	Coating	Collation	Box Count	Item Code
1"	Chisel	Brad	Bright	Sencote	34° Angled Tape Strip	4M	DA13EPBN
1¼"	Chisel	Brad	Bright	Sencote	34° Angled Tape Strip	4M	DA15EPBN
1½"	Chisel	Brad	Bright	Sencote	34° Angled Tape Strip	4M	DA17EPBN
1¾"	Chisel	Brad	Bright	Sencote	34° Angled Tape Strip	4M	DA19EPBN
2"	Chisel	Brad	Bright	Sencote	34° Angled Tape Strip	4M	DA21EPBN
2¼"	Chisel	Brad	Bright	Sencote	34° Angled Tape Strip	4M	DA23EPBN
2½"	Chisel	Brad	Bright	Sencote	34° Angled Tape Strip	3M	DA25EPB
1½"	Chisel	Brad	Bright	Sencote	34° Angled Tape Strip	0.7M (CS)	A301500
1¾"	Chisel	Brad	Bright	Sencote	34° Angled Tape Strip	0.7M (CS)	A301750
2"	Chisel	Brad	Bright	Sencote	34° Angled Tape Strip	0.7M (CS)	A302000
2½"	Chisel	Brad	Bright	Sencote	34° Angled Tape Strip	0.7M (CS)	A302500
1¼"	Chisel	Brad	Galv	Sencote	34° Angled Tape Strip	4M	DA15EABN
1½"	Chisel	Brad	Galv	Sencote	34° Angled Tape Strip	4M	DA17EABN
1¾"	Chisel	Brad	Galv	Sencote	34° Angled Tape Strip	4M	DA19EABN
2"	Chisel	Brad	Galv	Sencote	34° Angled Tape Strip	4M	DA21EABN
2½"	Chisel	Brad	Galv	Sencote	34° Angled Tape Strip	3M	DA25EAB
2"	Chisel	Brad	Galv	Sencote	34° Angled Tape Strip	0.7M (CS)	A302009
2½"	Chisel	Brad	Galv	Sencote	34° Angled Tape Strip	0.7M (CS)	A302509
2"	Chisel	Brad	Stainless 304	Plain	34° Angled Tape Strip	2M	DA21EGBN
2½"	Chisel	Brad	Stainless 304	Plain	34° Angled Tape Strip	1.2M	DA25EGB
1¼"	Diamond	Brad	Hardened*	Plain	34° Angled Tape Strip	4M	DA15AIA
1½"	Diamond	Brad	Hardened*	Plain	34° Angled Tape Strip	4M	DA17AIA
1¾"	Diamond	Brad	Hardened*	Plain	34° Angled Tape Strip	4M	DA19AIA

CS-Clamshell

*Hardened regular galvanized heat treated 15 Gauge for steel stud and trim application

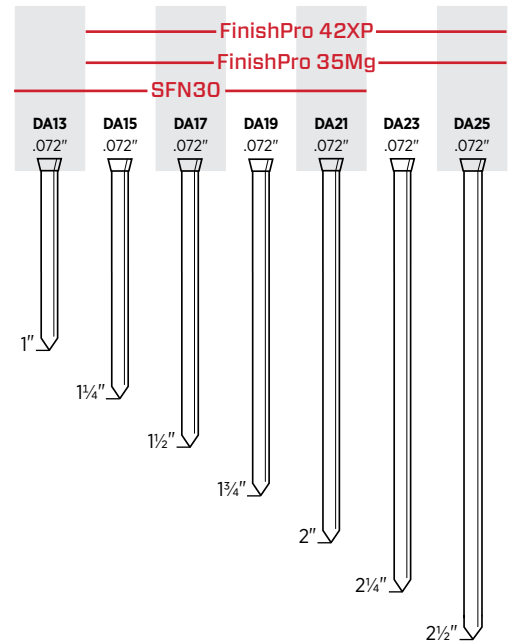

The Best Finish Nails in the Business.

SENCO® has the finish nails to meet all your finish and trim needs. In addition to offering a wide variety of fastener ranges and gauges, we offer a full line of tools that drive them.



19^{GA} 1/4" Crown Medium Wire Staples

Cabinets, drawers, soffits, lattice, casebacks						
Length	Point	Finish	Coating	Collation	Box Count	Item Code
1/2"	Chisel	Galv	Sencote	Glued	10M	K08BABN
5/8"	Chisel	Galv	Sencote	Glued	10M	K10BABN
3/4"	Chisel	Galv	Sencote	Glued	10M	K11BAB
7/8"	Chisel	Galv	Sencote	Glued	5M	K12BAB
1"	Chisel	Galv	Sencote	Glued	5M	K13BABN

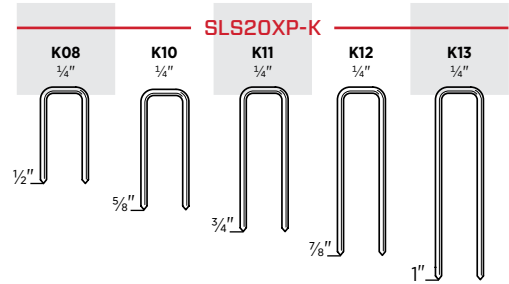

19^{GA} 3/16" Crown Medium Wire Staples

Cabinets, drawers, lattice, laminated hardwood flooring						
Length	Point	Finish	Coating	Collation	Box Count	Item Code
1/2"	Blunt	Galv	Sencote	Glued	10M	R08BAB
5/8"	Blunt	Galv	Sencote	Glued	5M	R10BAB
3/4"	Blunt	Galv	Sencote	Glued	5M	R11BAB
1"	Blunt	Galv	Sencote	Glued	5M	R13BAB

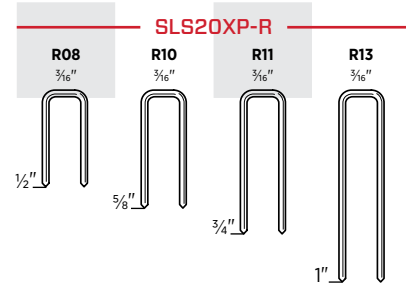

18^{GA} 1/4" Crown Medium Wire Staples

Cabinets, casebacks, drawers, upholstery, soffits, underlayment, lattice and insulation sheathing						
Length	Point	Finish	Coating	Collation	Box Count	Item Code
3/4"	Chisel	Bright	Sencote	Glued	5M	L11BRB
1"	Chisel	Bright	Sencote	Glued	5M	L13BRBN
1"	Chisel	Bright	Sencote	Glued	40M	L13BRBP
1 1/8"	Chisel	Bright	Sencote	Glued	5M	L14BRB
1 1/4"	Chisel	Bright	Sencote	Glued	5M	L15BRB
3/8"	Chisel	Galv	Sencote	Glued	10M	L06BAB
7/16"	Chisel	Galv	Sencote	Glued	24M	L07BABP
7/16"	Chisel	Galv	Sencote	Glued	24M	L07QBGP
1/2"	Chisel	Galv	Sencote	Glued	5M	L08BABN
1/2"	Chisel	Galv	Sencote	Glued	10M	L08BAB
5/8"	Chisel	Galv	Sencote	Glued	5M	L10BABN
5/8"	Cross Cut	Galv	Sencote	Glued	5M	L10HABN
3/4"	Chisel	Galv	Sencote	Glued	5M	L11BAB
3/4"	Cross Cut	Galv ¹	Sencote	Glued	5M	L11HBB
3/4"	Cross Cut	Galv	Sencote	Glued	5M	L11HAB
7/8"	Chisel	Galv	Sencote	Glued	5M	L12BAB
7/8"	Chisel	Galv	Sencote	Glued	5M	L12BQB
1"	Chisel	Galv	Sencote	Glued	5M	L13BABN
1"	Cross Cut	Galv	Sencote	Glued	5M	L13HABN
1 1/8"	Chisel	Galv	Sencote	Glued	5M	L14BAB
1 1/4"	Chisel	Galv	Sencote	Glued	5M	L15BAB
1 1/2"	Chisel	Galv	Sencote	Glued	5M	L17BAB
5/8"	Chisel	Galv	Sencote	Glued	1.2M (CS)	A800629
3/4"	Chisel	Galv	Sencote	Glued	0.9M (CS)	A800759
1"	Chisel	Galv	Sencote	Glued	0.9M (CS)	A801009
1 1/4"	Chisel	Galv	Sencote	Glued	0.7M (CS)	A801259
1 1/2"	Chisel	Galv	Sencote	Glued	0.6M (CS)	A801509
1/2"-1 1/2"	Chisel	Galv	Sencote	Glued	0.9M (CS)	A809909*
5/8"	Chisel	Stainless 304 ²	Plain	Glued	5M	L10BHA
3/4"	Chisel	Stainless 304	Plain	Glued	5M	L11BGA
1 1/8"	Chisel	Stainless 304	Plain	Glued	5M	L14BGA

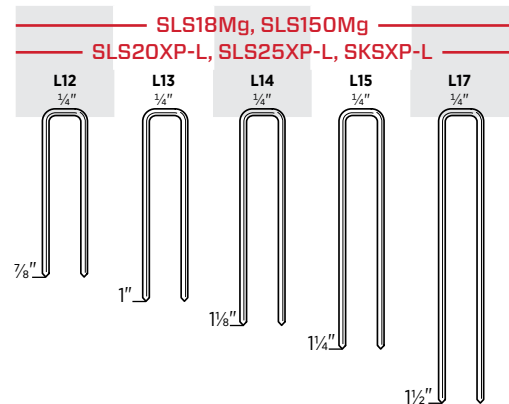
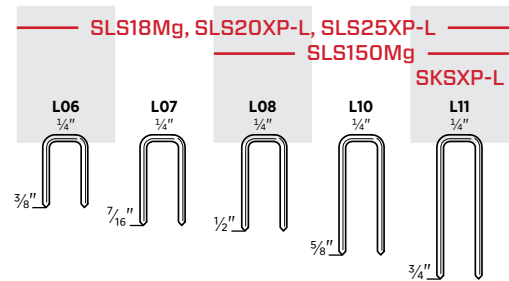

¹ Galvanized High Tensile, ² Stainless 304 Steel High Tensile
CS-Clamshell, *Variety Pack

18^{GA} 3/8" Crown Medium Wire Staples

Cabinets, casebacks, drawers, upholstery, soffits, underlayment, lattice and sheathing

Length	Point	Finish	Coating	Collation	Box Count	Item Code
5/8"	Chisel	Bright	Sencote	Glued	5M	M10BRBN
3/4"	Chisel	Bright	Sencote	Glued	5M	M11BRBN
1"	Chisel	Bright	Sencote	Glued	5M	M13BRB
3/8"	Chisel	Galv	Sencote	Glued	10M	M06BABN
1/2"	Chisel	Galv	Sencote	Glued	10M	M08BAB
5/8"	Chisel	Galv	Sencote	Glued	5M	M10BABN
3/4"	Chisel	Galv	Sencote	Glued	5M	M11BABN
7/8"	Chisel	Galv	Sencote	Glued	5M	M12BAB
1"	Chisel	Galv	Sencote	Glued	5M	M13BAB
1 1/4"	Chisel	Galv	Sencote	Glued	10M	M15BAB
1 1/2"	Chisel	Galv	Sencote	Glued	10M	M17BAB

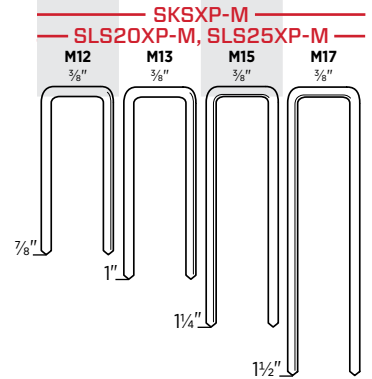
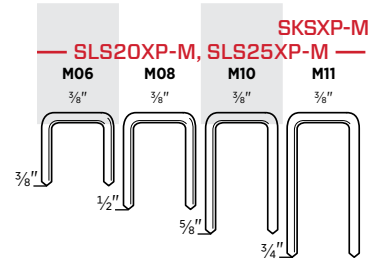

16^{GA} 7/16" Crown Heavy Wire Staples

Cabinets, casebacks, drawers, upholstery, soffits, underlayment, lattice and sheathing

Length	Point	Finish	Coating	Collation	Box Count	Item Code
3/4"	Chisel	Bright	Sencote	Glued	5M	N11BRB
1"	Chisel	Bright	Sencote	Glued	5M	N13BRB
1 1/8"	Chisel	Bright	Sencote	Taped	10M	N14BRB
1 1/4"	Chisel	Bright	Sencote	Taped	10M	N15BRB
1 3/8"	Chisel	Bright	Sencote	Taped	10M	N16BRB
1 3/8"	Step	Bright	Sencote	Taped	10M	N16RRB
1 1/2"	Chisel	Bright	Sencote	Taped	10M	N17BRB
1 5/8"	Chisel	Bright	Sencote	Taped	10M	N18BRB
1 3/4"	Chisel	Bright	Sencote	Taped	10M	N19BRB
2"	Chisel	Bright	Sencote	Taped	10M	N21BRB
1/2"	Chisel	Galv	Sencote	Taped	5M	N08BABN
1/2"	Chisel	Galv*	Sencote	Glued	5M	N08BBBN
1/2"	Diverg	Galv*	Sencote	Glued	5M	N08FBB
5/8"	Chisel	Galv	Sencote	Glued	5M	N10BAB
3/4"	Chisel	Galv	Sencote	Glued	5M	N11BAB
3/4"	Diverg	Galv*	Sencote	Glued	5M	N11FBB
7/8"	Chisel	Galv	Sencote	Glued	5M	N12BABN
7/8"	Diverg	Galv	Sencote	Glued	5M	N12FABN
1"	Chisel	Galv	Sencote	Glued	5M	N13BAB
1"	Diverg	Galv	Sencote	Glued	5M	N13FAB
1 1/8"	Chisel	Galv	Sencote	Taped	10M	N14BAB
1 1/8"	Diverg	Galv	Sencote	Glued	10M	N14FAB
1 1/4"	Chisel	Galv	Sencote	Taped	10M	N15BAB
1 1/4"	Diverg	Galv	Sencote	Glued	10M	N15FAB
1 3/8"	Chisel	Galv	Sencote	Taped	10M	N16BAB
1 1/2"	Chisel	Galv	Sencote	Taped	10M	N17BAB
1 1/2"	Chisel	Galv	Sencote	Glued	10M	N17BPE
1 5/8"	Chisel	Galv	Sencote	Taped	10M	N18BAB
1 3/4"	Chisel	Galv	Sencote	Taped	10M	N19BAB
1 3/4"	Chisel	Galv	Sencote	Glued	10M	N19BPE
2"	Chisel	Galv	Sencote	Taped	10M	N21BAB
2"	Chisel	Galv	Sencote	Glued	10M	N21BPE
1 1/4"	Chisel	Stainless 304	Sencote	Glued	3M	N15BGB
1 1/2"	Chisel	Stainless 304	Sencote	Glued	3M	N17BGB
1 3/4"	Chisel	Stainless 304	Sencote	Glued	3M	N19BGBN
2"	Chisel	Stainless 304	Sencote	Glued	3M	N21BGBN

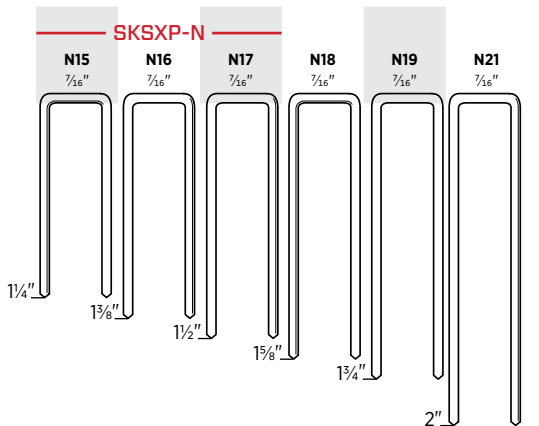
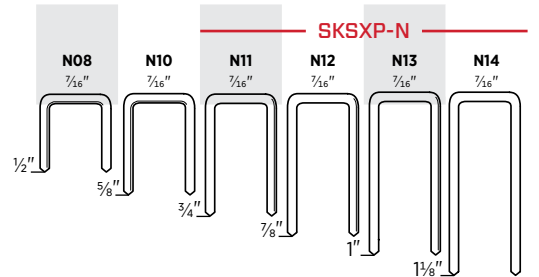

*Galvanized High Tensile

25^{GA} Sencor® 1" Crown Corrugated Fastener

Butt and miter joints						
Length	Point	Finish	Coating	Collation	Box Count	Item Code
¼"	Sharp Chisel	Bright	Plain	Glued	8M	X04NRA
⅜"	Sharp Chisel	Bright	Plain	Glued	5M	X06NRA
½"	Sharp Chisel	Bright	Plain	Glued	4M	X08NRA

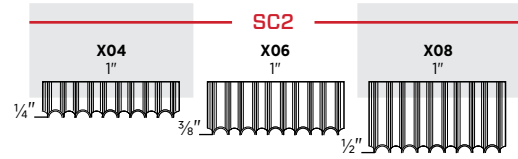

SENCOR® CORRUGATED FASTENERS

Sencor corrugated fasteners provide twice the joint strength of ordinary fasteners. Available in 1" crown and ¼", ⅜" and ½" lengths to ensure maximum joint strength. Use this fastener for butt and miter joints, truss construction, wooden boxes, pallet repair, cabinet and furniture frames.



25^{GA} Senclamp® 7/16" Crown Joint Fastener

Butt and miter joints						
Length	Point	Finish	Coating	Collation	Box Count	Item Code
5/16"	Chisel	Bright	Plain	Taped	3M	Y05BFA
7/16"	Chisel	Bright	Plain	Taped	3M	Y07BFA
9/16"	Chisel	Bright	Plain	Taped	3M	Y09BFAN

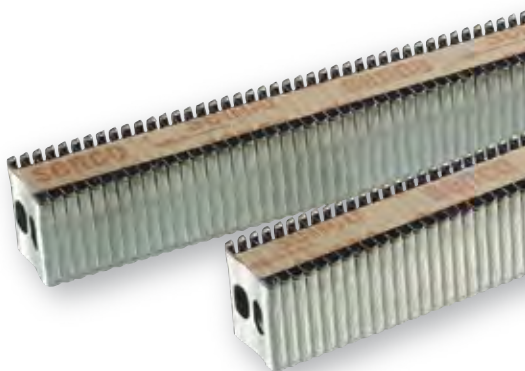
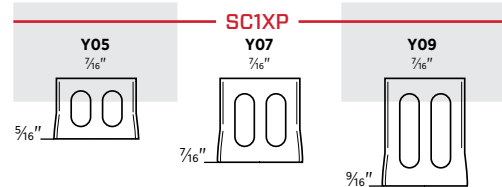

SENCLAMP® JOINT FASTENERS

Senclamp has a special webbed design that draws the material together as it drives through it. Made from carbon steel, fasteners are available in 7/16" crown and 5/16", 7/16" and 9/16" lengths to best suit your requirements. Designed for a wide range of joint fastening applications, Senclamp secures joints better, faster and for less.

FRAMING, SHEATHING & SUBFLOOR

NAILING THE RIGHT BALANCE OF SIZE, WEIGHT AND POWER

We offer a wide selection of strip and coil framing and sheathing nailers, including the award winning FramePro®325XP.

- Compact to maneuver around wall studs and floor joists easily
- Lightweight and ergonomic to reduce fatigue
- Built tough and powerful enough to drive fasteners into the most demanding substrates

APPLICATIONS

Framing, sheathing, truss building, installing subflooring, decking or fencing, assembling boxes or making pallets

FEATURES

- Low profile designs allow for easy access between studs and joists
- Highly efficient internal design for increased durability and less wear and tear on the compressor
- Dry fire lock out prevents dry firing and signals user when to reload
- Claw-like safety for precise toe-nailing



FramePro®325XP

3¼" PAPER TAPE FRAMING NAILER

ITEM #4Z0101N

34°



Features

- Patented TrueDrive magazine reduces jams and misfeeds
- Efficient internal design means less wear and tear on the compressor
- Claw-like toenail safety
- Fits easily between studs and joists

FramePro®701XP

3½" PAPER TAPE FRAMING NAILER

ITEM #2H0133N

34°



Features

- Straight-line 34° magazine for better line of sight
- Simple two-step loading
- Claw-like toenail safety
- Fits easily between studs and joists

PROHEAD® TECHNOLOGY



SENCO's offset full round head nail.

Design allows round ProHead® nails to be collated in a nested shank-to-shank 34° strip.

- Superior holding power
- Fewer partial drives
- Fewer pull-outs
- Superior strip integrity
- Proudly manufactured in Cincinnati, Ohio



Product Reference Chart

TOOL SPECS	FramePro®325XP	FramePro®701XP
Trigger	Selectable	Sequential
Operating Pressure	70-120 psi (4.8-8.3 bar)	70-120 psi (4.8-8.3 bar)
Air Consumption (60 CPM)	5.2 scfm	10 scfm
Air Inlet	¾" NPT	¾" NPT
Weight	7.9 lbs (3.58 kg)	8 lbs (3.62 kg)
Height	11.9" (302 mm)	13.25" (337 mm)
Length	17.3" (440 mm)	15.13" (384 mm)
Width	4.5" (114 mm)	4.17" (106 mm)
Main Body Material	Aluminum	Aluminum
Warranty	5 yrs	5 yrs
FASTENER SPECS	Fasteners are located on pages 45-53	
Range	2"-3¼"	2"-3½"
Shank	.113"-.148"	.113"-.148"
Capacity	83	70
Angle/Collation	34° Angled Tape Strip	34° Angled Tape Strip
Series	GC, GE, HC, HE, HF, KC ProHead G5, G6, H5, H6, K5, K6	GC, GE, HC, HE, HF, KC ProHead G5, G6, H5, H6, K5, K6
TOOL FEATURES		
Depth-of-Drive	Yes, Tool-Free	Yes, Tool-Free
Rafter Hook	Yes	Yes
Dry Fire Lockout	Yes	Yes

FramePro®325XP

3¼" PAPER TAPE FRAMING NAILER

ITEM #4Z0101N

34°



Features

- Patented TrueDrive magazine reduces jams and misfeeds
- Efficient internal design means less wear and tear on the compressor
- Claw-like toenail safety
- Fits easily between studs and joists

FramePro®701XP

3½" PAPER TAPE FRAMING NAILER

ITEM #2H0133N

34°



Features

- Straight-line 34° magazine for better line of sight
- Simple two-step loading
- Claw-like toenail safety
- Fits easily between studs and joists

PROHEAD® TECHNOLOGY



SENCO's offset full round head nail.

Design allows round ProHead® nails to be collated in a nested shank-to-shank 34° strip.

- Superior holding power
- Fewer partial drives
- Fewer pull-outs
- Superior strip integrity
- Proudly manufactured in Cincinnati, Ohio



Product Reference Chart

TOOL SPECS	FramePro®325XP	FramePro®701XP
Trigger	Selectable	Sequential
Operating Pressure	70-120 psi (4.8-8.3 bar)	70-120 psi (4.8-8.3 bar)
Air Consumption (60 CPM)	5.2 scfm	10 scfm
Air Inlet	¾" NPT	¾" NPT
Weight	7.9 lbs (3.58 kg)	8 lbs (3.62 kg)
Height	11.9" (302 mm)	13.25" (337 mm)
Length	17.3" (440 mm)	15.13" (384 mm)
Width	4.5" (114 mm)	4.17" (106 mm)
Main Body Material	Aluminum	Aluminum
Warranty	5 yrs	5 yrs
FASTENER SPECS	Fasteners are located on pages 45-53	
Range	2"-3¼"	2"-3½"
Shank	.113"-.148"	.113"-.148"
Capacity	83	70
Angle/Collation	34° Angled Tape Strip	34° Angled Tape Strip
Series	GC, GE, HC, HE, HF, KC ProHead G5, G6, H5, H6, K5, K6	GC, GE, HC, HE, HF, KC ProHead G5, G6, H5, H6, K5, K6
TOOL FEATURES		
Depth-of-Drive	Yes, Tool-Free	Yes, Tool-Free
Rafter Hook	Yes	Yes
Dry Fire Lockout	Yes	Yes

SCN60XP

2¾" COIL NAILER

ITEM #520101N

15°



Features

- High load capacity
- EZ-Load design saves time
- Fast cycle time increases productivity
- Lightweight for comfortable all-day use

SCN65XP

3½" COIL NAILER

ITEM #540101N - FLAT SAFETY; 540104N - TOENAIL SAFETY

15°



Features

- High load capacity
- EZ-Load design saves time
- Fast cycle time increases productivity
- Light and fast for greater productivity

SCN49XP

2½" COIL NAILER

ITEM #5J0001N

15°



Features

- Well balanced and lightweight
- Dual collation allows choice between wire or plastic collation

Product Reference Chart

TOOL SPECS	SCN60XP	SCN65XP	SCN49XP
Trigger	Contact	Contact	Selectable
Operating Pressure	70-120 psi (4.8-8.3 bar)	70-120 psi (4.8-8.3 bar)	70-120 psi (4.8-8.3 bar)
Air Consumption (60 CPM)	8.29 scfm	9.54 scfm	3.9 scfm
Air Inlet	¾" NPT	¾" NPT	¾" NPT
Weight	7.5 lbs (3.4 kg)	8 lbs (3.6 kg)	5.1 lbs (2.31 kg)
Height	12.38" (314 mm)	14.1" (359 mm)	12" (304 mm)
Length	12.88" (327 mm)	12.88" (327 mm)	12.25" (314 mm)
Width	5.38" (137 mm)	5.38" (137 mm)	5.19" (132 mm)
Main Body Material	Aluminum	Aluminum	Magnesium
Warranty	5 yrs	5 yrs	5 yrs
FASTENER SPECS	Fasteners are located on pages 45-53		
Range	2"-2¾"	2"-3½"	1¼"-2½"
Shank	.099"-.113"	.099"-.131"	.082"-.113"
Capacity	250-275	225-275	250-375
Angle/Collation	15° Flat Wire Welded Coil	15° Flat Wire Welded Coil	15° Flat Wire Welded or Plastic Carrier Coil
Series	BK, BL, BT, GD, GL, HR	BJ, BK, BL, BT, GD, GL, HD, HK, HL, KD	BE, BK, BL, BT, ED, EL, GD, GL, SE
TOOL FEATURES			
Depth-of-Drive	Yes, Tool-Free	Yes, Tool-Free	Yes, Tool-Free
Rafter Hook	No	No	No
Dry Fire Lockout	No	No	No

JoistPro™150XP

1½" METAL CONNECTOR NAILER

ITEM #7L0001N



34°

Features

- Patented nosepiece design exposes nail tip for accurate nail placement into pre-punched metal connector holes
- Powerful enough to drive through engineered lumber
- Lightweight and well balanced

JoistPro™250XP

1½"-2½" METAL CONNECTOR NAILER

ITEM #6K0001N



34°

Features

- Nosepiece probe locates metal connector holes, providing accurate nail placement
- Powerful enough to drive through engineered lumber
- Lightweight and well balanced

Mini Hand Nailer

2"-3½" BULK NAILER

ITEM #PC1195



Features

- Compact and powerful enough to drive 2"-3½" bulk nails
- Magnetic nose holds nail in place for safe, accurate placement
- Ultra-light at just 1 pound

A20 Hand Nailer

2"-7" BULK NAILER

ITEM #PC0781



Features

- Drives bulk nails from 2"-7"
- Soft rubber palm pad for comfortable grip
- Magnetic nose holds nail in place for safe, accurate placement
- Includes leather strap for comfort

Product Reference Chart

TOOL SPECS	JoistPro™150XP	JoistPro™250XP	Mini Hand Nailer	A20 Hand Nailer
Trigger	Sequential	Sequential	—	—
Operating Pressure	70-120 psi (4.8-8.3 bar)	70-120 psi (4.8-8.3 bar)	60-110 psi (4-7.6 bar)	50-125 psi (3.5-8.4 bar)
Air Consumption (60 CPM)	2.3 scfm	4.1 scfm	2-4 scfm	2-4 scfm
Air Inlet	¼" NPT	¼" NPT	¼" NPT	⅜" NPT
Weight	4.6 lbs (2.08 kg)	5.9 lbs (2.68 kg)	1 lb (.45 kg)	2.4 lbs (1.1 kg)
Height	11.97" (302 mm)	14.1" (359 mm)	4" (101 mm)	5.8" (122 mm)
Length	10.35" (263 mm)	13.8" (350 mm)	2.75" (70 mm)	4" (101 mm)
Width	4.0" (100 mm)	4.3" (110 mm)	2" (55.6 mm)	3.25" (83 mm)
Main Body Material	Magnesium	Magnesium	Aluminum	Aluminum
Warranty	5 yrs	5 yrs	1 yr	1 yr
FASTENER SPECS	Fasteners are located on pages 45-53			
Range	1½"	1½"-2½"	Bulk nails from 2"-3½"	Bulk nails from 2"-3½" up to 7" with opt. guide tips
Shank	.131"-.148"	.131"-.162"	—	.113"-.148"
Capacity	30	20	1	1
Angle/Collation	34° Paper Tape Strip	34° Paper Tape Strip	—	—
Series	KJ, MD	KJ, MD, ND	—	—
TOOL FEATURES				
Depth-of-Drive	No	Yes	—	—
Rafter Hook	Yes	Yes	—	—
Dry Fire Lockout	Yes	Yes	—	—

SCP40XP

1/2" STANDARD PRESSURE PNEUMATIC CONCRETE & STEEL PINNER

ITEM #7J0001N

0°



Features

- 10 times faster than powder-actuated systems
- No licensing required to operate
- Works with conventional air compressors, hoses and fittings
- Operates at extreme temperatures and altitudes

Concrete Pinner

Plaster, stucco & building wrap fastening attachment

	Fits Tools	Range	ITEM #	
SENCO	SCP40XP	1/4"	NPC035	 Magnetic washer nosepiece

Galvanized Metal Washer

ITEM #	Diameter	Box Count	Fits SCP40XP, GT40CP
SWM125B	1/4"	1M	.109" Dia. Concrete Pins

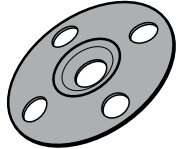

WC150XP

1" WIDE CROWN, 1/2" HEAVY WIRE STAPLER

ITEM #4W0001N

16 GA



Features

- Robust firing valve design makes the tool fast, powerful and easy to maintain
- High-strength composite magazine and metal magazine guide prevent wear
- Positive-locking adjustable depth-of-drive ensures consistently flush drives
- EZ-Clear™ latch virtually eliminates downtime caused by fastener jams

WC200XP

1" WIDE CROWN, 2" HEAVY WIRE STAPLER

ITEM #4Y0001N

16 GA



Features

- Robust firing valve design makes the tool fast, powerful and easy to maintain
- High-strength composite magazine and metal magazine guide prevent wear
- Positive-locking adjustable depth-of-drive ensures consistently flush drives
- EZ-Clear™ latch virtually eliminates downtime caused by fastener jams

Product Reference Chart

TOOL SPECS	SCP40XP	WC150XP	WC200XP
Trigger	Selectable	Contact	Contact
Operating Pressure	80-120 psi (5.5-8.3 bar)	70-120 psi (4.8-8.3 bar)	70-120 psi (4.8-8.3 bar)
Air Consumption (60 CPM)	5.2 scfm	3.18 scfm	3.45 scfm
Air Inlet	3/8" NPT	3/8" NPT	3/8" NPT
Weight	7.1 lbs (3.2 kg)	5 lbs (2.3 kg)	5.3 lbs (2.4 kg)
Height	12.22" (310 mm)	9" (229 mm)	10" (254 mm)
Length	18.2" (462 mm)	15.25" (387 mm)	15.25" (387 mm)
Width	4.5" (114.4 mm)	3.5" (89 mm)	3.5" (89 mm)
Main Body Material	Aluminum	Aluminum	Aluminum
Warranty	5 yrs	5 yrs	5 yrs
FASTENER SPECS	Fasteners are located on pages 45-53		
Shank/Crown	.109"/.118" Shanks	1" Crown	1" Crown
Range	1/2"-1 1/2"	5/8"-1 1/2"	7/8"-2"
Capacity	42	160	160
Angle/Collation	Straight Plastic Collated Strip	Straight Glued Strip	Straight Glued and Taped Strip
Series	W3	P	P
TOOL FEATURES			
Depth-of-Drive	No	Yes, Tool-Free	Yes, Tool-Free
Belt Hook	No	Yes	Yes
Dry Fire Lockout	Yes	No	No

SNS41

7/16" CROWN, 2" HEAVY WIRE STAPLER

ITEM #3L0003N

17_{GA} 16_{GA}



Features

- Durable construction minimizes downtime and operating costs
- EZ-Clear™ latch virtually eliminates downtime caused by fastener jams
- Fast, multidirectional stitching

SQS55XP

7/16" CROWN, 2 1/2" HEAVY WIRE STAPLER

ITEM #660101N

15_{GA}



Features

- Fast — up to 15 staples per second
- EZ-Clear™ latch virtually eliminates downtime caused by fastener jams
- Rugged dependability

SNS200XP

7/16" CROWN, 2" HEAVY WIRE STAPLER

ITEM #7B0001N

16_{GA} 17_{GA}



Features

- 15% more powerful than all other construction staplers in its class
- Innovative magazine-removal mechanism maintains a clean, narrow line of sight for precise staple placement
- 1" lip length allows access into tight corners
- Convert your SNS200XP and SNS200XP-BST into a vinyl siding stapler

Vinyl Siding Attachment (Sold Separately)

Convert SNS200XP and SNS200XP-BST into vinyl siding stapler

Fits Tools	ITEM #	
SNS200XP	HC0748	
SNS200XP-BST	HC0748	

Product Reference Chart

TOOL SPECS	SNS41	SNS200XP	SQS55XP
Trigger	Contact	Contact	Contact
Operating Pressure	80-120 psi (5.5-8.3 bar)	70-120 psi (4.8-8.3 bar)	80-120 psi (5.5-8.3 bar)
Air Consumption (60 CPM)	5.4 scfm	3.5 scfm	6.54 scfm
Air Inlet	3/8" NPT	3/8" NPT	3/8" NPT
Weight	4.6 lbs (2.1 kg)	5.3 lbs (2.4 kg)	5.9 lbs (2.7 kg)
Height	10.75" (273 mm)	11" (279 mm)	12" (305 mm)
Length	15" (381 mm)	15" (381 mm)	14.38" (365 mm)
Width	3.4" (86 mm)	3.5" (89 mm)	3.6" (92 mm)
Main Body Material	Aluminum	Aluminum	Aluminum
Warranty	5 yrs	5 yrs	5 yrs
FASTENER SPECS	Fasteners are located on pages 45-53		
Crown	7/16"	7/16"	7/16"
Range	1"-2"	1"-2"	1 1/4"-2 1/2"
Capacity	160	160	130
Angle/Collation	Straight Glued and Taped Strip	Straight Glued and Taped Strip	Straight Glued and Taped Strip
Series	N, O	N, O	Q
TOOL FEATURES			
Depth-of-Drive	Yes, Tool-Required	Yes, Tool-Free	Yes, Tool-Required
Belt Hook	No	Yes	No
Dry Fire Lockout	No	No	No

FRAMING, SHEATHING & SUBFLOOR FASTENERS

34° ProHead® Smooth Paper Tape Nails

Framing, sheathing, subfloor, decks, trusses and pallets

Length	Point	Finish	Coating	Collation	Box Count	Item Code
2" x .113"	Diamond	Bright	Plain	34° Paper Tape Strip	2.5M	G521APBXN
2 3/8" x .113"	Diamond	Bright	Sencote	34° Paper Tape Strip	2.5M	G524APBXN
3" x .120"	Diamond	Bright	Sencote	34° Paper Tape Strip	2.5M	H527APBXN
3" x .120"	Diamond	Bright	Sencote	34° Paper Tape Strip	0.5M	H527APBXR
3 1/4" x .120"	Diamond	Bright	Sencote	34° Paper Tape Strip	2.5M	H528APBXN
2 1/2" x .131"	Diamond	Bright	Sencote	34° Paper Tape Strip	2M	K525APBXN
3" x .131"	Diamond	Bright	Sencote	34° Paper Tape Strip	2.5M	K527APBXN
3" x .131"	Diamond	Bright	Sencote	34° Paper Tape Strip	0.5M	K527APBXR
3 1/4" x .131"	Diamond	Bright	Sencote	34° Paper Tape Strip	2.5M	K528APBXN
3 1/4" x .131"	Diamond	Bright	Sencote	34° Paper Tape Strip	0.5M	K528APBXR
3 1/2" x .131"	Diamond	Bright	Sencote	34° Paper Tape Strip	2.5M	K529APBXN
2" x .113"	Diamond	Hot Dip	Sencote	34° Paper Tape Strip	2.5M	G521ASBXN
2 3/8" x .113"	Diamond	Hot Dip	Sencote	34° Paper Tape Strip	2.5M	G524ASBXN
3" x .120"	Diamond	Hot Dip	Sencote	34° Paper Tape Strip	2.5M	H527ASBXN
3" x .131"	Diamond	Hot Dip	Sencote	34° Paper Tape Strip	2.5M	K527ASBXN
3 1/4" x .131"	Diamond	Hot Dip	Sencote	34° Paper Tape Strip	2.5M	K528ASBXN
3 1/2" x .131"	Diamond	Hot Dip	Sencote	34° Paper Tape Strip	2.5M	K529ASBXN

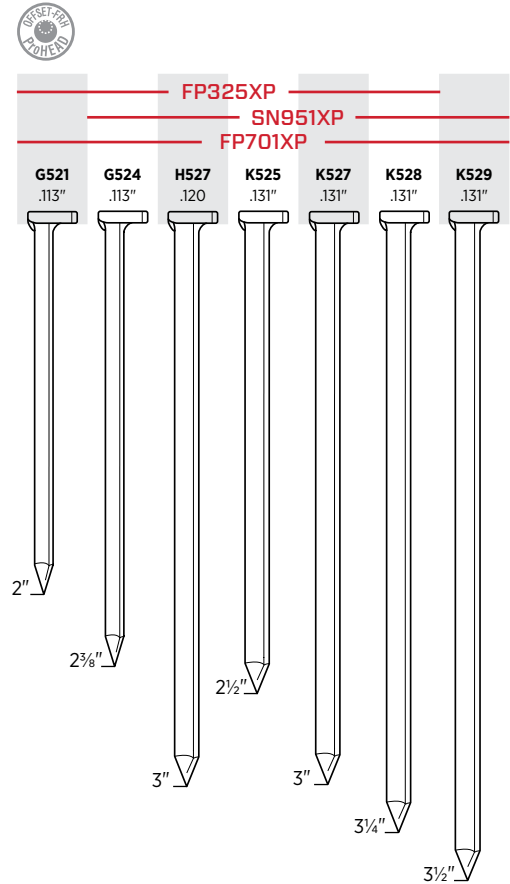

34° ProHead® Ring Paper Tape Nails

Framing, sheathing, subfloor, decks, trusses and pallets

Length	Point	Finish	Coating	Collation	Box Count	Item Code
2" x .113"	Diamond	Bright	Sencote	34° Paper Tape Strip	2.5M	G621APBXN
2 3/8" x .113"	Diamond	Bright	Sencote	34° Paper Tape Strip	2.5M	G624APBXN
3" x .120"	Diamond	Bright	Sencote	34° Paper Tape Strip	2.5M	H627APBXN
3 1/4" x .131"	Diamond	Bright	Sencote	34° Paper Tape Strip	2.5M	K628APBXN
2" x .113"	Diamond	Hot Dip	Sencote	34° Paper Tape Strip	2.5M	G621ASBXN
2 3/8" x .113"	Diamond	Hot Dip	Sencote	34° Paper Tape Strip	0.5M	G624ASBXR
2 3/8" x .113"	Diamond	Hot Dip	Sencote	34° Paper Tape Strip	2.5M	G624ASBXN
3" x .120"	Diamond	Hot Dip	Sencote	34° Paper Tape Strip	2.5M	H627ASBXN
3" x .120"	Diamond	Hot Dip	Sencote	34° Paper Tape Strip	0.5M	H627ASBXR
3" x .131"	Diamond	Hot Dip	Sencote	34° Paper Tape Strip	2.5M	K627ASBXN
3 1/4" x .131"	Diamond	Hot Dip	Sencote	34° Paper Tape Strip	2.5M	K628ASBXN
3 1/2" x .131"	Diamond	Hot Dip	Sencote	34° Paper Tape Strip	2.5M	K629ASBXN

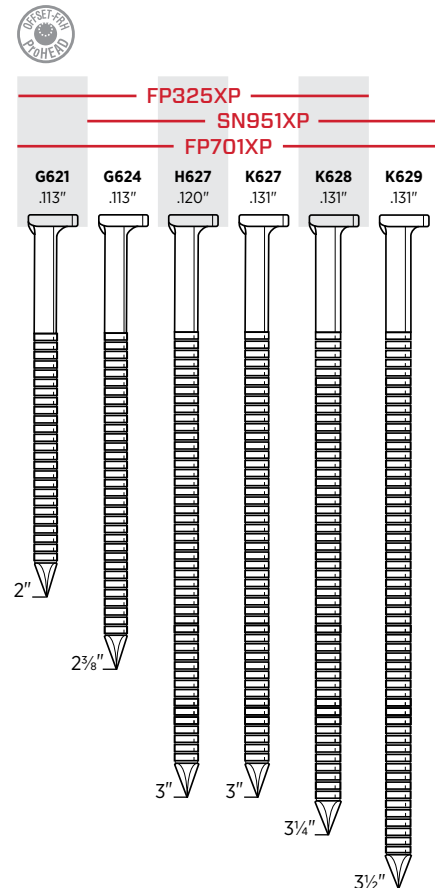

FRAMING, SHEATHING & SUBFLOOR FASTENERS

34° Smooth Shank Paper Tape Collated Nails

Framing, sheathing, subfloor, decks, trusses and pallets						
Length	Point	Finish	Coating	Collation	Box Count	Item Code
2¼" x .113"	Diamond	Bt. Hardened	Plain	34° Paper Tape Strip	1M	GC23AHAK
2" x .113"	Diamond	Bright	Sencote	34° Paper Tape Strip	2.5M	GC21APBX
2¼" x .113"	Diamond	Bright	Sencote	34° Paper Tape Strip	2.5M	GC23APBX
2⅜" x .113"	Diamond	Bright	Sencote	34° Paper Tape Strip	2.5M	GC24APBX
2½" x .113"	Diamond	Bright	Sencote	34° Paper Tape Strip	2.5M	GC25APBX
3" x .120"	Diamond	Bright	Sencote	34° Paper Tape Strip	2.5M	HC27APBX
3¼" x .120"	Diamond	Bright	Sencote	34° Paper Tape Strip	2.5M	HC28APBX
3" x .131"	Diamond	Bright	Sencote	34° Paper Tape Strip	2.5M	KC27APBX
3¼" x .131"	Diamond	Bright	Sencote	34° Paper Tape Strip	2.5M	KC28APBX
3½" x .131"	Diamond	Bright	Sencote	34° Paper Tape Strip	2.5M	KC29APBX
3½" x .135"	Diamond	Bright	Sencote	34° Paper Tape Strip	2.5M	LC29APBX
4" x .131"	Diamond	Bright	Sencote	34° Paper Tape Strip	2.5M	KC31APBX
2½" x .113"	Diamond	Galv	Sencote	34° Paper Tape Strip	2.5M	GC25AABX
2⅜" x .113"	Diamond	Hot Dip	Sencote	34° Paper Tape Strip	2.5M	GC24ASBX
3" x .120"	Diamond	Hot Dip	Sencote	34° Paper Tape Strip	2.5M	HC27ASBX
3" x .131"	Diamond	Hot Dip	Sencote	34° Paper Tape Strip	2.5M	KC27ASBX
3¼" x .131"	Diamond	Hot Dip	Sencote	34° Paper Tape Strip	2.5M	KC28ASBX
3½" x .131"	Diamond	Hot Dip	Sencote	34° Paper Tape Strip	2.5M	KC29ASBX
3" x .131"	Diamond	Stainless 304	Sencote	34° Paper Tape Strip	1M	KC27AGBK
3¼" x .131"	Diamond	Stainless 304	Sencote	34° Paper Tape Strip	1M	KC28AGBK

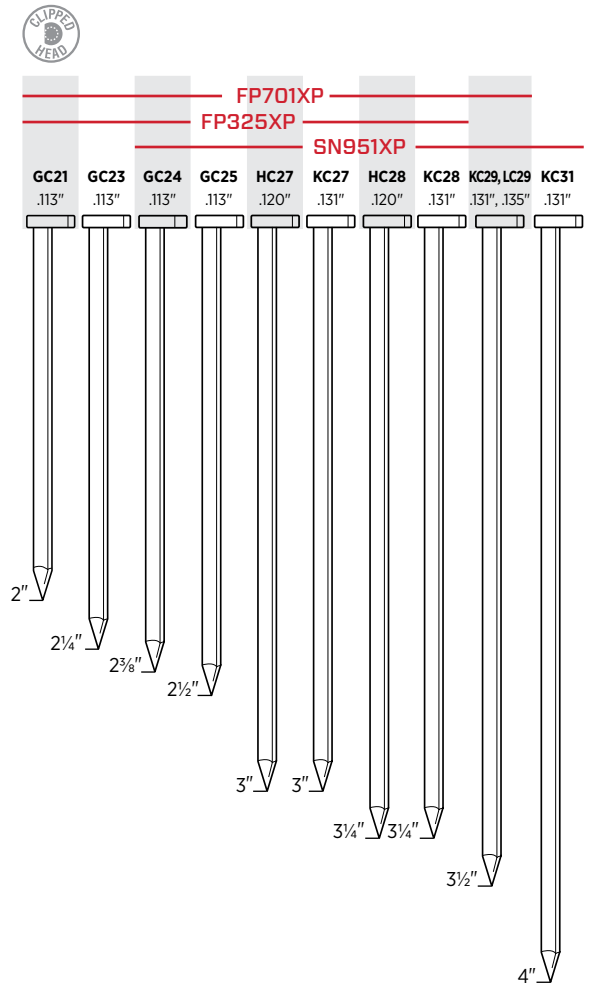

34° Ring Shank Paper Tape Collated Nails

Framing, sheathing, subfloor, decks, trusses and pallets						
Length	Point	Finish	Coating	Collation	Box Count	Item Code
2" x .113"	Diamond	Bright	Plain	34° Paper Tape Strip	2.5M	GE21APAX
2⅜" x .113"	Diamond	Bright	Sencote	34° Paper Tape Strip	2.5M	GE24APBX
2" x .113"	Diamond	Hot Dip	Sencote	34° Paper Tape Strip	2.5M	GE21ASBX
2⅜" x .113"	Diamond	Hot Dip	Sencote	34° Paper Tape Strip	2.5M	GE24ASBX
3" x .120"	Diamond	Hot Dip	Sencote	34° Paper Tape Strip	2.5M	HE27ASBX
2⅜" x .113"	Diamond	Stainless 304	Sencote	34° Paper Tape Strip	1M	GE24AGBK

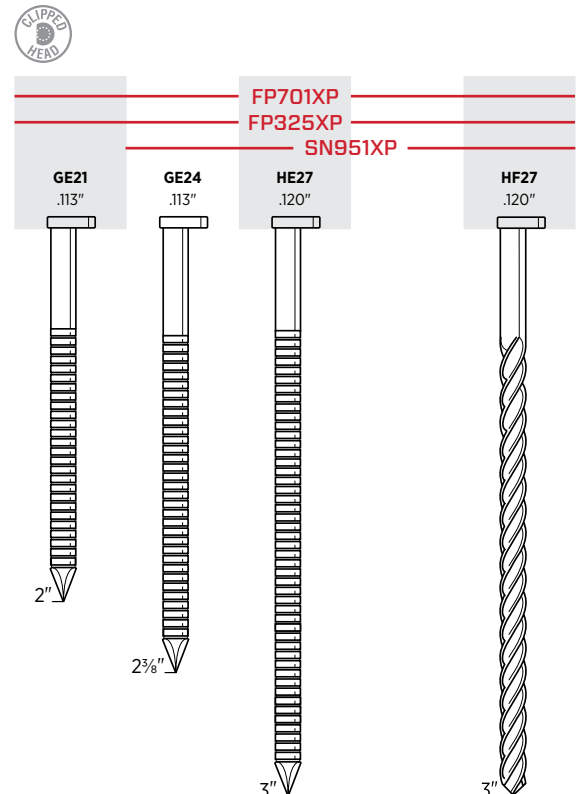

34° Screw Shank Paper Tape Collated Nails

Framing, sheathing, subfloor, decks, trusses and pallets						
Length	Point	Finish	Coating	Collation	Box Count	Item Code
3" x .120"	Chisel	Bright	Plain	34° Paper Tape Strip	3.1M	HF27EPAK
3" x .120"	Chisel	Bright	Sencote	34° Paper Tape Strip	1M	HF27EDB
3" x .120"	Diamond	Stainless 304	Sencote	34° Paper Tape Strip	1M	HF27AGBK

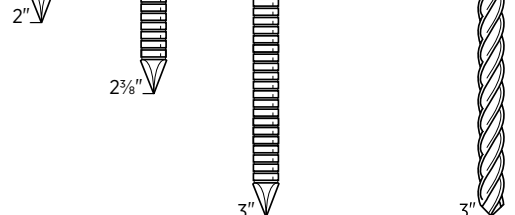

FRAMING, SHEATHING & SUBFLOOR FASTENERS

20° Smooth Shank Plastic Collated Nails

Framing, sheathing, subfloor, decks, trusses and pallets						
Length	Point	Finish	Coating	Collation	Box Count	Item Code
2¼" x .113"	Diamond	Bt. Hardened	Plain	20° Plastic Strip	2.8M	GD23AHAS
2" x .113"	Diamond	Bright	Sencote	20° Plastic Strip	5M	GD21APBSN
2¼" x .148"	Diamond	Bright	Sencote	20° Plastic Strip	4M	MD23APBSN
2¾" x .113"	Diamond	Bright	Sencote	20° Plastic Strip	4M	GD24APBSN
2½" x .113"	Diamond	Bright	Sencote	20° Plastic Strip	5M	GD25APBSN
2½" x .131"	Diamond	Bright	Sencote	20° Plastic Strip	4M	KD25APBSN
3" x .120"	Diamond	Bright	Sencote	20° Plastic Strip	4M	HD27APBSN
3" x .131"	Diamond	Bright	Sencote	20° Plastic Strip	4M	KD27APBSN
3" x .131"	Diamond	Bright	Sencote	20° Plastic Strip	0.5M	KD27APBSR
3" x .148"	Diamond	Bright	Sencote	20° Plastic Strip	4M	MD27APBSR
3¼" x .131"	Diamond	Bright	Sencote	20° Plastic Strip	4M	KD28APBSN
3¼" x .131"	Diamond	Bright	Sencote	20° Plastic Strip	0.5M	KD28APBSR
3¼" x .148"	Diamond	Bright	Sencote	20° Plastic Strip	4M	MD28APBSN
3½" x .131"	Diamond	Bright	Sencote	20° Plastic Strip	4M	KD29APBSN
2" x .113"	Diamond	Galv	Sencote	20° Plastic Strip	5M	GD21AABSNS
2¾" x .113"	Diamond	Hot Dip	Sencote	20° Plastic Strip	2.5M	GD24ASBS
2½" x .113"	Diamond	Galv	Sencote	20° Plastic Strip	5M	GD25AABSNS
2½" x .120"	Diamond	Exterior	Sencote	20° Plastic Strip	2.3M	HJ25ADBS*
2½" x .131"	Diamond	Galv	Sencote	20° Plastic Strip	2.5M	KD25AABS
3" x .131"	Diamond	Hot Dip	Sencote	20° Plastic Strip	2.5M	KD27ASBS
3¼" x .131"	Diamond	Hot Dip	Sencote	20° Plastic Strip	2.5M	KD28ASBS
3½" x .131"	Diamond	Hot Dip	Sencote	20° Plastic Strip	2.5M	KD29ASBS
2¾" x .113"	Diamond	Stainless 304	—	20° Plastic Strip	1M	GD24AGES
3¼" x .131"	Diamond	Stainless 304	Sencote	20° Plastic Strip	1M	KD28AGBS

*Roof tile nails, drive with FramePro® 725XP or SN952XP

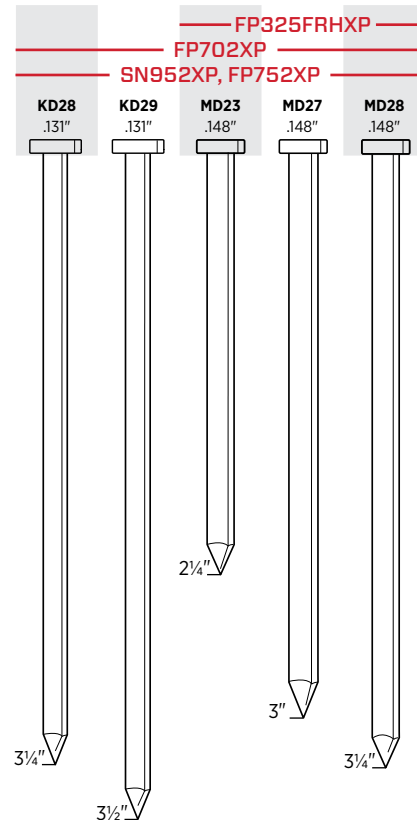
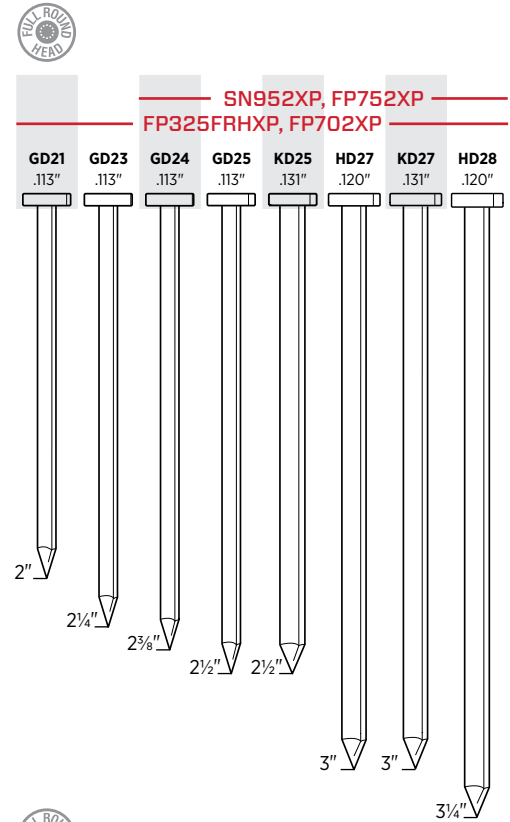

FRAMING, SHEATHING & SUBFLOOR FASTENERS

20° Ring Shank Plastic Collated Nails

Framing, sheathing, subfloor, decks, trusses and pallets						
Length	Point	Finish	Coating	Collation	Box Count	Item Code
2 ³ / ₈ " x .113"	Diamond	Hot Dip	Sencote	20° Plastic Strip	0.5M	GL24ASBSR
2" x .113"	Diamond	Bright	Sencote	20° Plastic Strip	5M	GL21APBSN
2 ³ / ₈ " x .113"	Diamond	Bright	Sencote	20° Plastic Strip	5M	GL24APBSN
2" x .113"	Diamond	Hot Dip	Sencote	20° Plastic Strip	2.5M	GL21ASBS
2 ³ / ₈ " x .113"	Diamond	Galv	Sencote	20° Plastic Strip	5M	GL24AABSNS
2 ³ / ₈ " x .113"	Diamond	Galv	Sencote	20° Plastic Strip	2.5M	M002042
2 ³ / ₈ " x .113"	Diamond	Hot Dip	Sencote	20° Plastic Strip	2.5M	GL24ASBS
3" x .120"	Diamond	Hot Dip	Sencote	20° Plastic Strip	2.5M	HL27ASBS
2 ³ / ₈ " x .113"	Diamond	Stainless 304	Sencote	20° Plastic Strip	1M	GL24AGBS
3" x .120"	Diamond	Stainless 304	Sencote	20° Plastic Strip	1M	HL27AGBS
2 ¹ / ₂ " x .120"	Diamond	Stainless 316	—	20° Plastic Strip	1M	HL25AUES
3" x .131"	Diamond	Stainless 316	—	20° Plastic Strip	1M	KL27AUES
3 ¹ / ₄ " x .131"	Diamond	Stainless 316	—	20° Plastic Strip	1M	KL28AUES

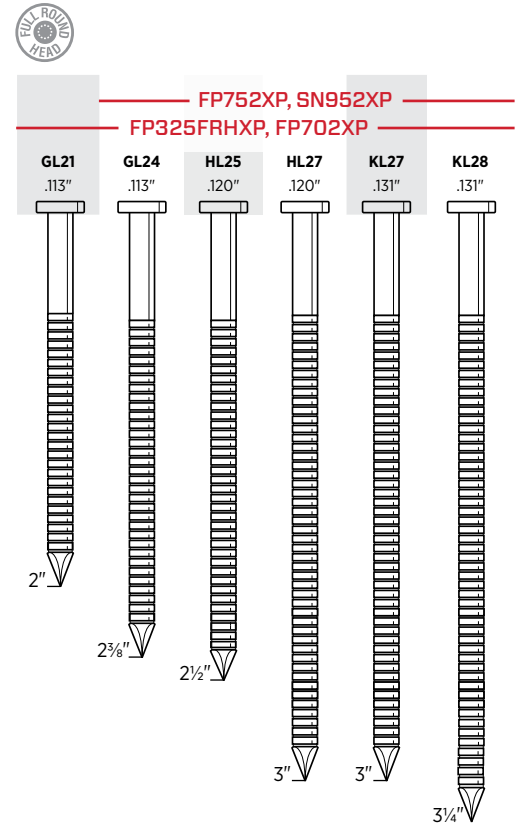

20° Screw Shank Plastic Collated Nails

Framing, sheathing, subfloor, decks, trusses and pallets						
Length	Point	Finish	Coating	Collation	Box Count	Item Code
3" x .120"	Diamond	Stainless 316	—	20° Plastic Strip	1M	HK27AUES

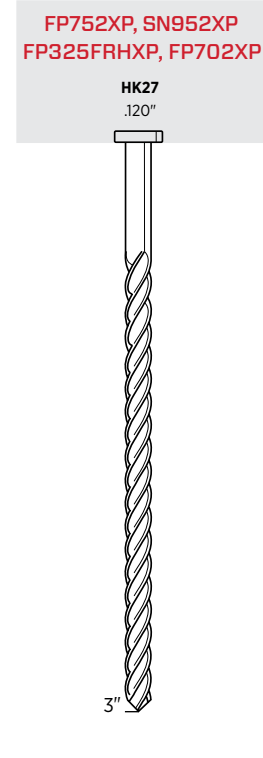

15° Ring Shank Subflooring Nails

Superior fastening in subfloor applications						
Length	Point	Finish	Coating	Collation	Box Count	Item Code
2"	Diamond	Bright Basic	Sencote	15° Flat Wire Welded Coil	6.6M	BT21APBF

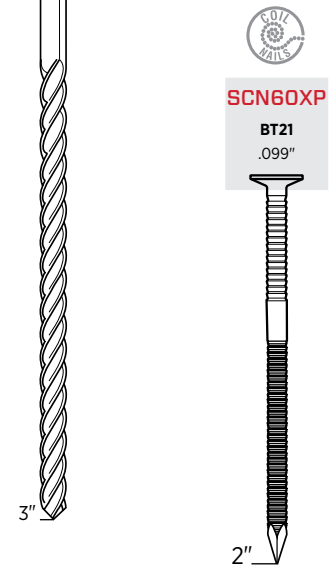

FRAMING, SHEATHING & SUBFLOOR FASTENERS

15° Smooth Shank Coil Nails

Framing, sheathing, pallets, subfloor, decks and trusses						
Length	Point	Finish	Coating	Collation	Box Count	Item Code
2" x .113"	Diamond	Bright	Sencote	15° Flat Wire Welded Coil	6M	GD21APBF
2 3/8" x .113"	Diamond	Bright	Sencote	15° Flat Wire Welded Coil	6M	GD24APBF
2 1/2" x .113"	Diamond	Bright	Sencote	15° Flat Wire Welded Coil	6M	GD25APBF
2 1/2" x .131"	Diamond	Bright	Sencote	15° Flat Wire Welded Coil	3.6M	KD25APBF
3" x .120"	Diamond	Bright	Sencote	15° Flat Wire Welded Coil	4M	HD27APBF
3" x .131"	Diamond	Bright	Sencote	15° Flat Wire Welded Coil	3.6M	KD27APBF
3 1/4" x .120"	Diamond	Bright	Sencote	15° Flat Wire Welded Coil	4M	HD28APBF
3 1/4" x .131"	Diamond	Bright	Sencote	15° Flat Wire Welded Coil	3.6M	KD28APBF
3 1/2" x .131"	Diamond	Bright	Sencote	15° Flat Wire Welded Coil	3.6M	KD29APBF
5" x .148"	Diamond	Bright	Sencote	15° Flat Wire Welded Coil	1.8M	MD34APBF
2" x .113"	Diamond	Galv	Sencote	15° Flat Wire Welded Coil	6M	GD21AABF
2 1/2" x .113"	Diamond	Galv	Sencote	15° Flat Wire Welded Coil	6M	GD25AABF
3" x .131"	Diamond	Hot Dip	Sencote	15° Flat Wire Welded Coil	2.4M	KD27ASBF
3 1/4" x .131"	Diamond	Hot Dip	Sencote	15° Flat Wire Welded Coil	2.4M	KD28ASBF

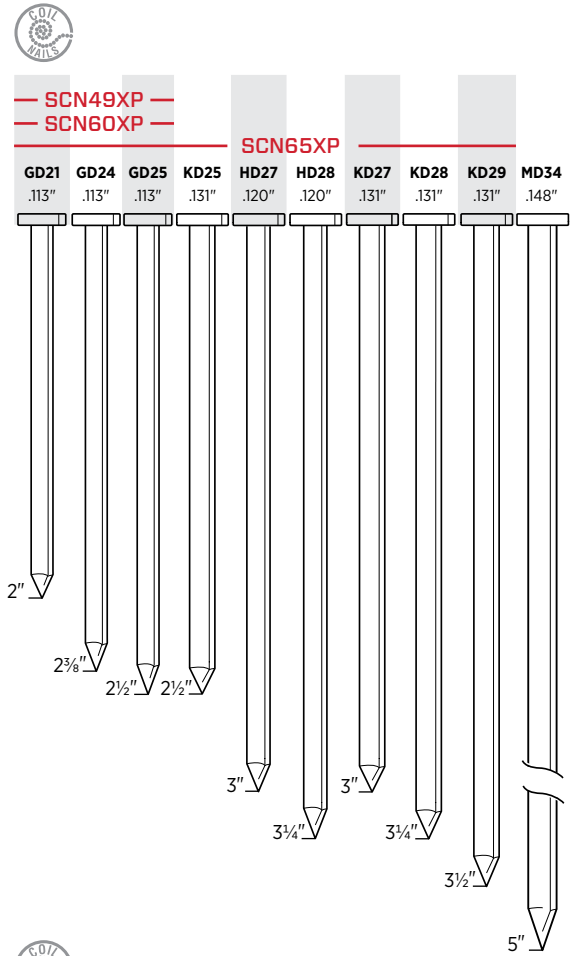

15° Ring Shank Coil Nails

Framing, sheathing, pallets, subfloor, decks and trusses						
Length	Point	Finish	Coating	Collation	Box Count	Item Code
2" x .099"	Diamond	Bright	Sencote	15° Flat Wire Welded Coil	6.6M	BL21APBF
2" x .099"	Diamond	Bright	Sencote	15° Flat Wire Welded Coil	6.6M	BT21APBF
2" x .113"	Diamond	Bright	Sencote	15° Flat Wire Welded Coil	6M	GL21APBF
2 1/4" x .099"	Diamond	Bright	Sencote	15° Flat Wire Welded Coil	6.6M	BL23APBF
2 3/8" x .113"	Diamond	Bright	Sencote	15° Flat Wire Welded Coil	6M	GL24APBF
2 1/4" x .099"	Diamond	Galv	Sencote	15° Flat Wire Welded Coil	6.6M	BE23AABF
2 3/8" x .113"	Diamond	Hot Dip	Sencote	15° Flat Wire Welded Coil	2.7M	GL24ASBF
3" x .120"	Diamond	Hot Dip	Sencote	15° Flat Wire Welded Coil	2.4M	HL27ASBF
2 3/8" x .113"	Diamond	Stainless 304	Sencote	15° Flat Wire Welded Coil	2.7M	GL24AGBF
1 3/4" x .120"	Diamond	Stainless 304	—	15° Flat Wire Welded Coil	3.6M	HL19AGEH
3" x .120"	Diamond	Stainless 304	Sencote	15° Flat Wire Welded Coil	2.4M	HL27AGBF

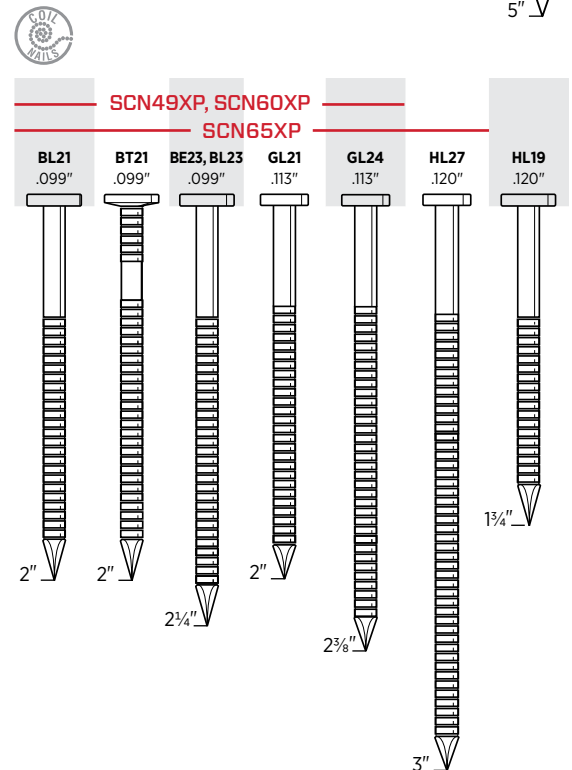

FRAMING, SHEATHING & SUBFLOOR FASTENERS

15° Screw Shank Coil Nails

Framing, sheathing, pallets, subfloor, decks and trusses						
Length	Point	Finish	Coating	Collation	Box Count	Item Code
2" x .099"	Blunt Dia.	Bright	Sencote	15° Flat Wire Welded Coil	9M	BK21BPBFN
2" x .099"	Chisel	Bright	Sencote	15° Flat Wire Welded Coil	6.6M	BK21EPBF
2¼" x .099"	Blunt Dia.	Bright	Sencote	15° Flat Wire Welded Coil	9M	BK23BPBFN
2¼" x .099"	Chisel	Bright	Sencote	15° Flat Wire Welded Coil	6.6M	BK23EPBF
2½" x .099"	Blunt Dia.	Bright	Sencote	15° Flat Wire Welded Coil	6M	BK25BPBFN
3" x .120"	Diamond	Bright	Sencote	15° Flat Wire Welded Coil	4M	HK27APBFN

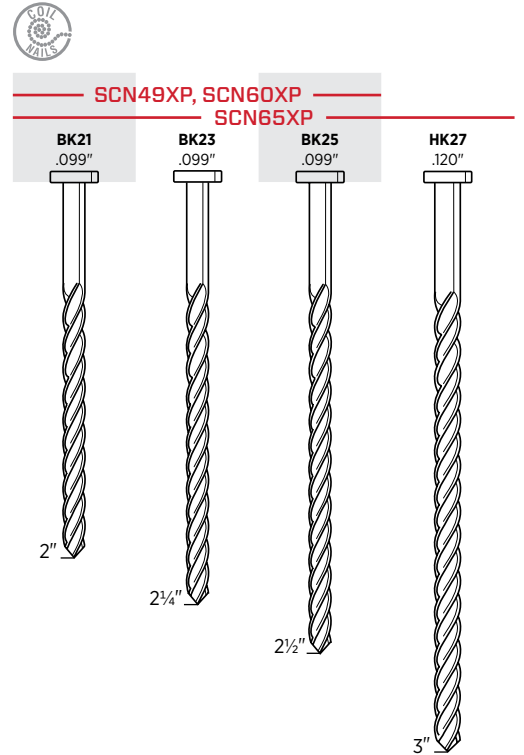

15° Smooth Shank Stiff-Stock Coil Nails

For fastening wood to masonry						
Length	Point	Finish	Coating	Collation	Box Count	Item Code
1½" x .099"	Diamond	Bright	Sencote	15° Flat Wire Welded Coil	3M	M003011
2¼" x .099"	Diamond	Bright	Sencote	15° Flat Wire Welded Coil	3M	M003012

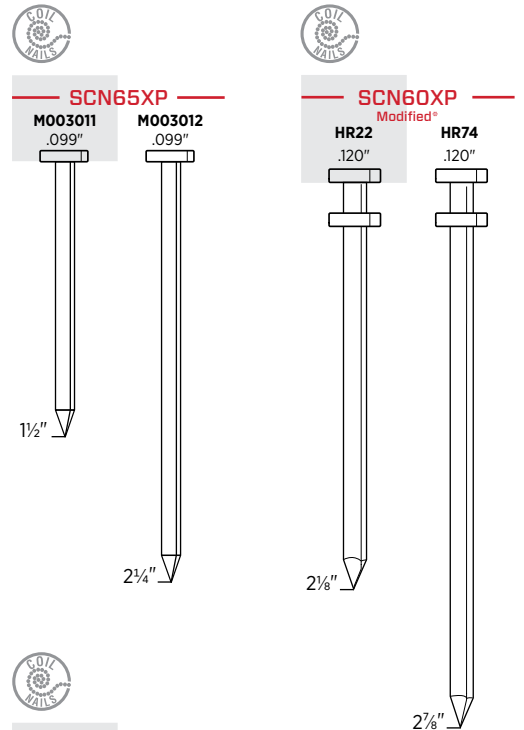

15° Duplex Smooth Shank Coil Nails*

Framing, trusses, crating and concrete forms						
Length	Point	Finish	Coating	Collation	Box Count	Item Code
2½" x .120"	Diamond	Bright	Plain	15° Flat Wire Welded Coil	5.4M	HR22APAF
2⅞" x .120"	Diamond	Bright	Plain	15° Flat Wire Welded Coil	3.6M	HR74APAF

*Requires a special-order modified SCN60XP tool (order XA1739)

15° Drywall Ring Shank Bugle Head Coil Nails

For fastening drywall to wood						
Length	Point	Finish	Coating	Collation	Box Count	Item Code
1½" x .099"	Diamond	Galv	Plain	15° Conical Wire Welded Coil	9.6M	BG17AAA
1½" x .099"	Diamond	Galv	Plain	15° Conical Wire Welded Coil	6.4M	BG17AAAQ
1⅝" x .099"	Diamond	Galv	Plain	15° Conical Wire Welded Coil	9.6M	BG18AAA
1⅝" x .099"	Diamond	Galv	Plain	15° Conical Wire Welded Coil	6.4M	BG18AAAQ

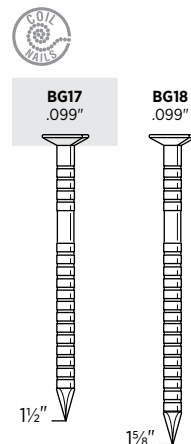

0°

Collated Concrete and Steel Pins

For fastening drywall track, wood furring, hat channels, metal washers or ceiling grid to concrete, concrete block and steel

Length	Point	Finish	Coating	Collation	Box Count	Item Code
½" x .109"/.118"	Pinched	Zinc Plated	Plain	Straight Plastic Collated Strip	1M	W3050YXS
¾" x .109"	Pinched	Black Oxide	Plain	Straight Plastic Collated Strip	1M	W3075PXC
¾" x .109"	Pinched	Zinc Plated	Plain	Straight Plastic Collated Strip	1M	W3075YXC
1" x .109"	Pinched	Zinc Plated	Plain	Straight Plastic Collated Strip	1M	W3100YXC
1¼" x .109"	Pinched	Zinc Plated	Plain	Straight Plastic Collated Strip	1M	W3125YXC

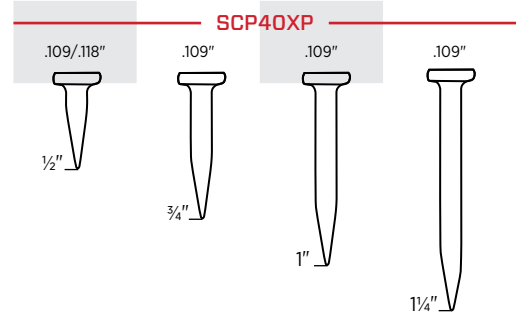

34°

Heat Treated Metal Connector Nails

Joist hangers, foundation anchors, seismic and hurricane straps and ties

Length	Point	Finish	Coating	Collation	Box Count	Item Code
1½" x .131"	Diamond	Bright	Plain	34° Paper Tape Strip	2M	KJ17AHBD
1½" x .148"	Diamond	Bright	Plain	34° Paper Tape Strip	2M	MD17AHBD
2½" x .131"	Diamond	Bright	Plain	34° Paper Tape Strip	2M	KJ25AHBD
2½" x .148"	Diamond	Bright	Plain	34° Paper Tape Strip	1.5M	MD25AHBD
2½" x .162"	Diamond	Bright	Plain	34° Paper Tape Strip	1.2M	ND25AHBD
1½" x .131"	Diamond	Hot Dip	Plain	34° Paper Tape Strip	2M	KJ17AEBD
1½" x .148"	Diamond	Hot Dip	Plain	34° Paper Tape Strip	2M	MD17AEBD
2½" x .131"	Diamond	Hot Dip	Plain	34° Paper Tape Strip	2M	KJ25AEBD
2½" x .148"	Diamond	Hot Dip	Plain	34° Paper Tape Strip	1.5M	MD25AEBD
2½" x .162"	Diamond	Hot Dip	Plain	34° Paper Tape Strip	1.2M	ND25AEBD

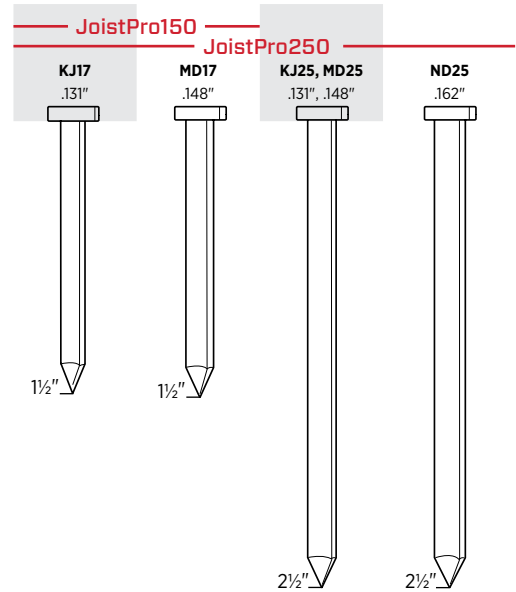

34°

Non-Heat Treated Metal Connector Nails

Standard tensile, non-hardened nails for use in joist hangers, foundation anchors, seismic and hurricane straps and ties

Length	Point	Finish	Coating	Collation	Box Count	Item Code
1½" x .131"	Diamond	Bright	Plain	34° Paper Tape Strip	2M	M002261
1½" x .148"	Diamond	Bright	Plain	34° Paper Tape Strip	2M	M002263
2½" x .148"	Diamond	Bright	Plain	34° Paper Tape Strip	1.5M	M002265
2½" x .162"	Diamond	Bright	Plain	34° Paper Tape Strip	1.2M	M002267
1½" x .131"	Diamond	Hot Dip	Plain	34° Paper Tape Strip	2M	M002262
1½" x .148"	Diamond	Hot Dip	Plain	34° Paper Tape Strip	2M	M002264
2½" x .148"	Diamond	Hot Dip	Plain	34° Paper Tape Strip	1.5M	M002266
2½" x .162"	Diamond	Hot Dip	Plain	34° Paper Tape Strip	1.2M	M002268

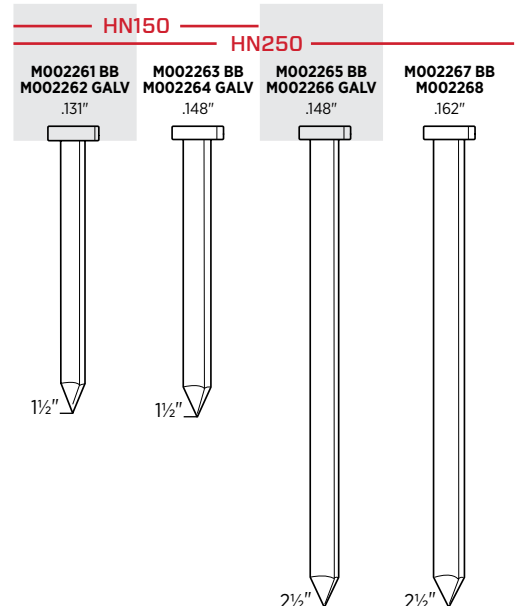

FRAMING, SHEATHING & SUBFLOOR FASTENERS

16^{GA}

1" Crown Heavy Wire Staples

Sheathing, house wrap, composite roofing, roofing felt, corrugated containers, foam insulation board, furniture/cabinet frames and butt joints

Length	Point	Finish	Coating	Collation	Box Count	Item Code
3/8"	Chisel	Galv	Plain	Glued	10M	P06BAA
1/2"	Chisel	Galv	Sencote	Taped	10M	P08BABT
5/8"	Chisel	Galv	Sencote	Taped	10M	P10BAB
5/8"	Divergent	Galv	Sencote	Glued	10M	P10FAB
5/8"	Chisel	Galv	Coated	Glued	10M	P10BPE
3/4"	Chisel	Galv	Sencote	Taped	10M	P11BAB
3/4"	Chisel	Galv	Coated	Glued	10M	P11BPE
7/8"	Chisel	Galv	Sencote	Taped	10M	P12BAB
1"	Chisel	Galv	Sencote	Taped	10M	P13BAB
1"	Chisel	Galv	Sencote	Glued	10M	P13BPE
1 1/4"	Chisel	Galv	Sencote	Taped	10M	P15BAB
1 1/4"	Chisel	Galv	Coated	Glued	10M	P15BPE
1 1/2"	Chisel	Galv	Sencote	Taped	10M	P17BAB
1 3/4"	Chisel	Galv	Sencote	Taped	5M	P19BAB
2"	Chisel	Galv	Sencote	Taped	5M	P21BAB
1"	Outside Chisel	Stainless 304	Sencote	Taped	5M	P13BGBN

*WC150XP Short Staples: order kit #YK0786 to drive staples under 5/8"

Use kit #YK0786 with WC150XP for 3/8"-5/8" staples

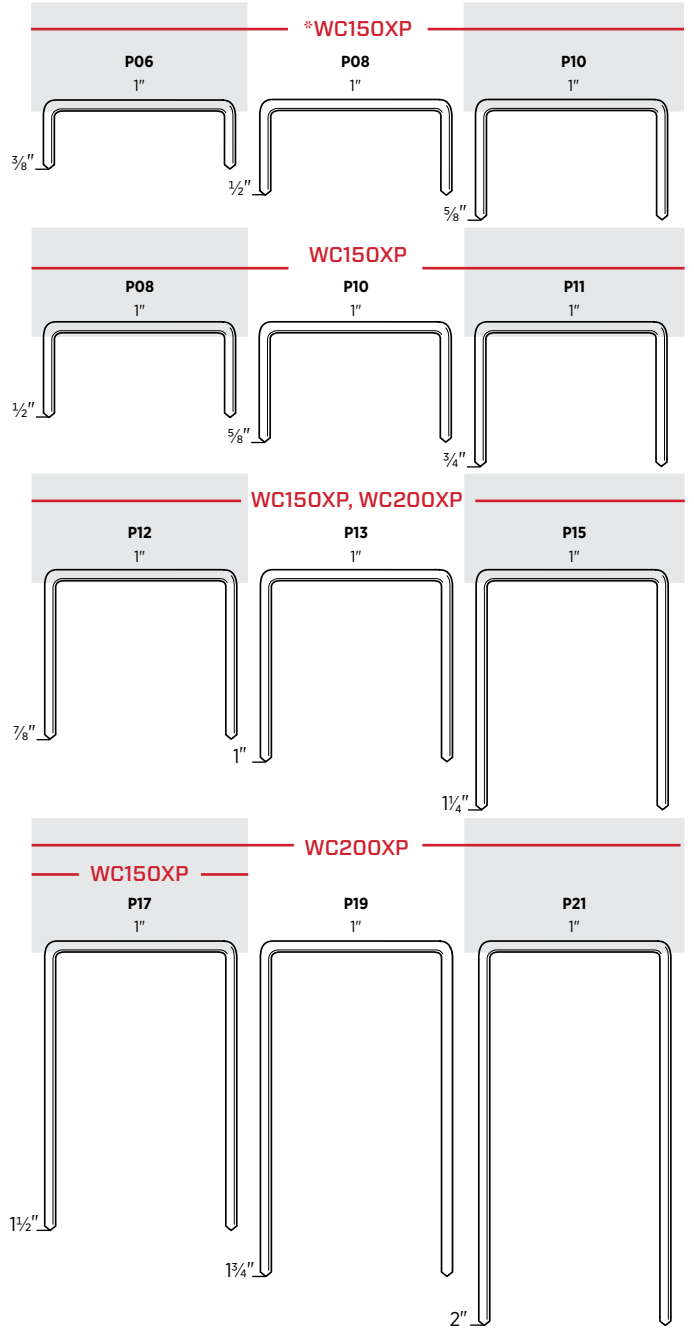

17^{GA}

7/16" Crown Heavy Wire Staples*

Sheathing, subfloor, furniture frames and crates

Length	Point	Finish	Coating	Collation	Box Count	Item Code
1 1/4"	Chisel	Bright	Sencote	Glued	10M	O15BRBB
1 3/8"	Chisel	Bright	Sencote	Glued	10M	O16BRBB
1 1/2"	Chisel	Bright	Sencote	Glued	10M	O17BRBB
1 5/8"	Chisel	Bright	Sencote	Glued	10M	O18BRBB
1 3/4"	Chisel	Bright	Sencote	Glued	10M	O19BRBB

*These staples drive only from SNS200XP, SNS200XP-BST staplers; SNS41 staplers manufactured after 09/2010; and SNS44XP and SNS45XP staplers manufactured after 05/2010. For older tools, order upgrade kits SNS41-YK0794, SNS44-YK0793, SNS45-FA0186.

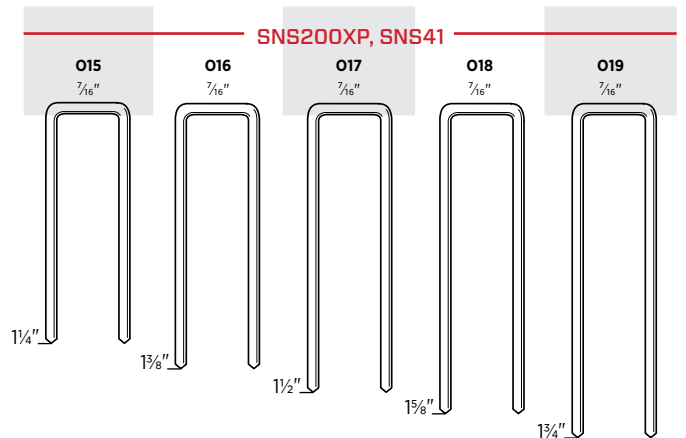

FRAMING, SHEATHING & SUBFLOOR FASTENERS

16^{GA}

7/16" Crown Heavy Wire Staples

Sheathing, soffits, underlayment, lattice, cabinets, casebacks and drawers

Length	Point	Finish	Coating	Collation	Box Count	Item Code
3/4"	Chisel	Bright	Sencote	Glued	5M	N11BRB
1"	Chisel	Bright	Sencote	Glued	5M	N13BRB
1 1/8"	Chisel	Bright	Sencote	Taped	10M	N14BRB
1 1/4"	Chisel	Bright	Sencote	Taped	10M	N15BRB
1 3/8"	Chisel	Bright	Sencote	Taped	10M	N16BRB
1 3/8"	Step	Bright	Sencote	Glued	10M	N16RRB
1 1/2"	Chisel	Bright	Sencote	Taped	10M	N17BRB
1 5/8"	Chisel	Bright	Sencote	Taped	10M	N18BRB
1 3/4"	Chisel	Bright	Sencote	Taped	10M	N19BRB
2"	Chisel	Bright	Sencote	Taped	10M	N21BRB
1/2"	Chisel	Galv	Sencote	Glued	5M	N08BABN
1/2"	Chisel	Galv*	Sencote	Glued	5M	N08BBBN
1/2"	Diverg	Galv*	Sencote	Glued	5M	N08FBB
5/8"	Chisel	Galv*	Sencote	Glued	5M	N10BAB
3/4"	Chisel	Galv	Sencote	Glued	5M	N11BAB
3/4"	Diverg	Galv*	Sencote	Glued	5M	N11FBB
7/8"	Chisel	Galv	Sencote	Glued	5M	N12BABN
7/8"	Diverg	Galv	Sencote	Glued	5M	N12FABN
1"	Chisel	Galv	Sencote	Glued	5M	N13BAB
1"	Diverg	Galv	Sencote	Glued	5M	N13FAB
1 1/8"	Chisel	Galv	Sencote	Taped	10M	N14BAB
1 1/8"	Diverg	Galv	Sencote	Glued	10M	N14FAB
1 1/4"	Chisel	Galv	Sencote	Taped	10M	N15BAB
1 1/4"	Diverg	Galv	Sencote	Glued	10M	N15FAB
1 3/8"	Chisel	Galv	Sencote	Taped	10M	N16BAB
1 1/2"	Chisel	Galv	Sencote	Taped	10M	N17BAB
1 1/2"	Chisel	Galv	Sencote	Glued	10M	N17BPE
1 5/8"	Chisel	Galv	Sencote	Taped	10M	N18BAB
1 3/4"	Chisel	Galv	Sencote	Taped	10M	N19BAB
1 3/4"	Chisel	Galv	Sencote	Glued	10M	N19BPE
2"	Chisel	Galv	Sencote	Taped	10M	N21BAB
2"	Chisel	Galv	Sencote	Glued	10M	N21BPE
1 1/4"	Chisel	Stainless 304	Sencote	Glued	3M	N15BGB
1 1/2"	Chisel	Stainless 304	Sencote	Glued	3M	N17BGB
1 3/4"	Chisel	Stainless 304	Sencote	Glued	3M	N19BGBN
2"	Chisel	Stainless 304	Sencote	Glued	3M	N21BGBN

*Galvanized High-Tensile Steel

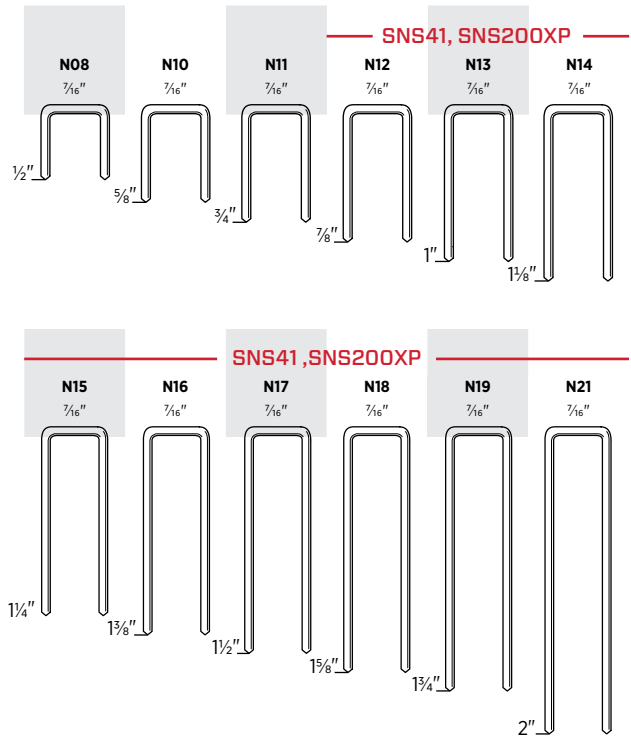

15^{GA}

7/16" Crown Heavy Wire Staples

Framing, sheathing, subflooring, decking, lathing, door and window units, fencing, pallets, crate and box assembly, furring and furniture framing

Length	Point	Finish	Coating	Collation	Box Count	Item Code
1 1/2"	Chisel	Bright	Sencote	Taped	5M	Q17BRB
1 3/4"	Chisel	Bright	Sencote	Taped	5M	Q19BRB
2"	Chisel	Bright	Sencote	Taped	5M	Q21BRB
2 1/4"	Chisel	Bright	Sencote	Taped	5M	Q23BRB
2 1/2"	Chisel	Bright	Sencote	Taped	5M	Q25BRB
1 1/4"	Chisel	Galv	Sencote	Taped	5M	Q15BAB
1 1/2"	Chisel	Galv	Sencote	Taped	5M	Q17BAB
1 3/4"	Chisel	Galv	Sencote	Taped	5M	Q19BAB
2"	Chisel	Galv	Sencote	Taped	5M	Q21BAB
2 1/4"	Chisel	Galv	Sencote	Taped	5M	Q23BAB
2 1/2"	Chisel	Galv	Sencote	Taped	5M	Q25BAB
1 3/4"	Chisel	Stainless 304	Sencote	Taped	2.2M	Q19BGBN
2 1/2"	Chisel	Stainless 304	Sencote	Taped	1M	Q25BGBN

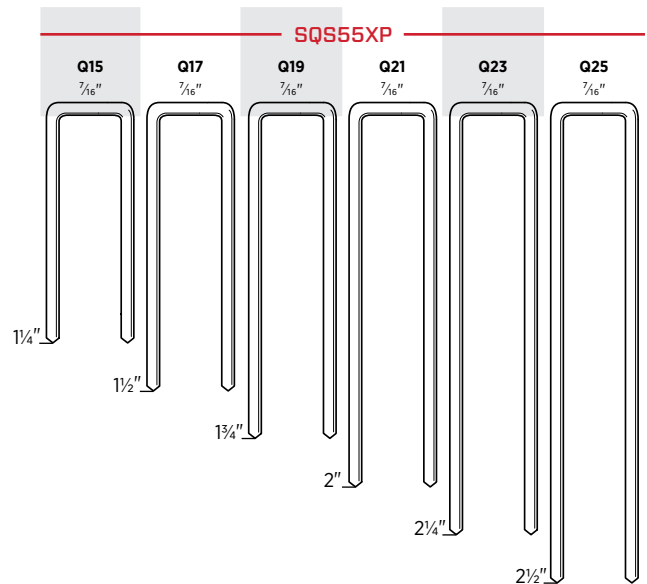

ROOFING, SIDING & FENCING

WE COVER IT ALL

When it comes to roofing applications or installing siding, uptime is everything. SENCO has designed a full line of tools and fasteners to maximize your productivity.

Our new RoofPro™445XP with its innovative firing valve uses 5% less air. A bi-metal driver blade increases durability. And our power in, power out feed system is air driven for stability and speed.

APPLICATIONS

SENCO offers a variety of coil nailers and crown staplers with fasteners optimized for different types of shingles, siding, sheathing, and felt underlayment.

FEATURES

- High-strength housings
- Long-lasting wear plates
- Easy, one-handed operation
- Adjustable depth-of-drive



RoofPro™455XP

1¾" COIL NAILER

ITEM #3D0101N

15°



Features

- Hardened wear plates and safety for extended reliability and parts life
- Adjustable nail canister accepts entire range of roofing nails
- Metal wear plate in nail canister reduces wear and improves nail feed
- Adjustable shingle guide

RoofPro™445XP

1¾" COIL NAILER

ITEM #8V0001N

15°



Features

- Innovative firing valve reduces air consumption without compromising power or speed
- Bi-metal driver blade reduces wear and improves durability
- Power in, power out feed system improves speed and delivers consistent drives
- Metal wear plate in nail canister reduces wear and helps improve nail feed
- Adjustable and removable shingle guide

SCN49XP

2½" COIL NAILER

ITEM #5J0001N

15°



Features

- Well balanced and lightweight
- Dual collation allows choice between wire or plastic collation
- High load capacity



It doesn't cost a bundle to drive the very best.



— Building Code Approved

— Professional Performance

Product Reference Chart

TOOL SPECS	RoofPro™455XP	RoofPro™445XP	SCN49XP
Trigger	Contact	Contact	Selectable
Operating Pressure	70-120 psi (4.8-8.3 bar)	70-120 psi (4.8-8.3 bar)	70-120 psi (4.8-8.3 bar)
Air Consumption (60 CPM)	6.54 scfm	3.86 scfm	3.9 scfm
Air Inlet	¼" NPT	¼" NPT	⅜" NPT
Weight	5.4 lbs (2.5 kg)	5.2 lbs (2.35 kg)	5.1 lbs (2.31 kg)
Height	10.5" (267 mm)	10.9" (276 mm)	12" (304 mm)
Length	10.25" (260 mm)	10.6" (269 mm)	12.25" (314 mm)
Width	4.5" (114 mm)	4.5" (114 mm)	5.19" (132 mm)
Main Body Material	Aluminum	Aluminum	Magnesium
Warranty	5 yrs	5 yrs	5 yrs
FASTENER SPECS	Fasteners are located on pages 57-59		
Range	¾"-1¾"	¾"-1¾"	1¼"-2½"
Shank	.120"	.120"	.082"-.113"
Capacity	120	120	250-375
Angle/Collation	15° Flat Wire Welded Coil	15° Flat Wire Welded Coil	15° Flat Wire Welded or Plastic Carrier Coil
Series	HJ, M00	HJ, M00	BE, BK, BL, BT, ED, EL, GD, GL, SE
TOOL FEATURES			
Depth-of-Drive	Yes, Tool-Free	Yes, Tool-Free	Yes, Tool-Free
Tool-Free Jam Clearing	Yes	Yes	Yes
Adjustable Exhaust	Yes	No	Yes

WC150RXP

1" CROWN 1½" ROOFING STAPLER

ITEM #4X0001N

16_{GA}



Features

- High-strength composite magazine
- EZ-Clear latch virtually eliminates downtime caused by fastener jams
- Hardened wear plates and safety for extended reliability and parts life

BC58

½" CROWN ⅝" STAPLE + 1" BUTTON CAP

ITEM #4A0001N

21_{GA}



Features

- EZ-Load system for staples and caps
- Ultra-lightweight for ease of use and maneuverability
- Balanced and fast for greater productivity
- Side-mounted cap collator holds caps regardless of tool position

A11

⅞" CROWN ⅜" HAMMER STAPLER

ITEM #PC0700

20_{GA}



Features

- Rugged all-steel construction
- Easy to service and maintain
- Comfortable fluted handle with grip

Product Reference Chart

TOOL SPECS	WC150RXP	BC58	A11
Trigger	Contact	Contact	—
Operating Pressure	70–120 psi (4.8–8.3 bar)	60–95 psi (4.1–6.5 bar)	—
Air Consumption (60 CPM)	3.18 scfm	.77 scfm	—
Air Inlet	⅜" NPT	¼" NPT	—
Weight	5.5 lbs (2.5 kg)	4.1 lbs (2 kg)	2 lbs (.9 kg)
Height	9" (229 mm)	8.5" (216 mm)	1.75" (44.4 mm)
Length	15.25" (387 mm)	12.5" (317 mm)	12.3" (312.4 mm)
Width	4" (105 mm)	3.5" (89 mm)	—
Main Body Material	Aluminum	Aluminum	Steel
Warranty	5 yrs	5 yrs	1 yr
FASTENER SPECS	Fasteners are located on pages 57–59		
Gauge	16	21	20
Crown	1"	½"	⅞"
Range	⅝"–1½"	⅝" Galv.	⅜"
Capacity	160	110	168
Angle/Collation	Straight Glued and Taped Strip	Glued Staple, Laser Welded Cap	Straight Glued Strip
Series	P	M004092, Button Cap	H
TOOL FEATURES			
Depth-of-Drive	Yes, Tool-Free	No	—
Tool-Free Jam Clearing	Yes	No	Yes
Adjustable Exhaust	No	Yes	—

ROOFING, SIDING & FENCING FASTENERS

15° Smooth Shank Coil Nails

Siding, asphalt and fiberglass shingles and vapor barriers						
Length	Point	Finish	Coating	Collation	Box Count	Item Code
3/4" x .120"	Diamond	Galv	Plain	15° Flat Wire Welded Coil	7.2M	M003101
7/8" x .120"	Diamond	Galv	Plain	15° Flat Wire Welded Coil	7.2M	M003102
1" x .120"	Diamond	Galv	Plain	15° Flat Wire Welded Coil	7.2M	M003103
1 1/4" x .120"	Diamond	Hot Dip	Plain	15° Flat Wire Welded Coil	7.2M	HJ15ASAP
1 1/4" x .120"	Diamond	Galv	Plain	15° Flat Wire Welded Coil	7.2M	M003104
1 1/2" x .120"	Diamond	Galv	Plain	15° Flat Wire Welded Coil	7.2M	M003105
1 3/4" x .120"	Diamond	Galv	Plain	15° Flat Wire Welded Coil	7.2M	M003106

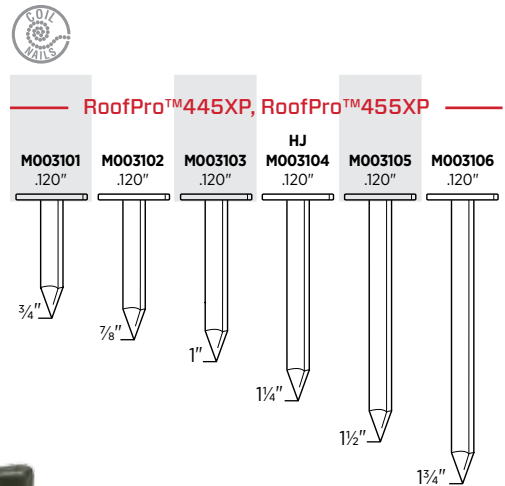

Vinyl Siding Attachment (Sold Separately)

Convert RoofPro™445XP and RoofPro™455XP into vinyl siding nailer	
Fits Tool	Item Code
RoofPro™445XP	HA0308
RoofPro™455XP	MA0013



0° Ring Shank Coil Nails

Siding and fencing						
Length	Point	Finish	Coating	Collation	Box Count	Item Code
1 7/8" x .092"	Diamond	Stainless 304	-	0° Plastic Carrier Coil	3.6M	EL20AGEB
2 1/4" x .092"	Diamond	Stainless 304	-	0° Plastic Carrier Coil	3.6M	EL23AGEB
1 7/8" x .099"	Diamond	Aluminum	-	0° Plastic Carrier Coil	9M	FL20AMEB

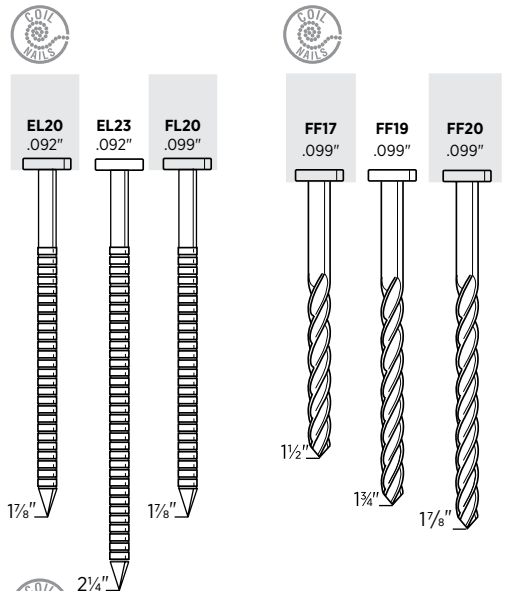

0° Screw Shank Coil Nails

Siding and fencing						
Length	Point	Finish	Coating	Collation	Box Count	Item Code
1 1/2" x .099"	Diamond	Aluminum	-	0° Plastic Carrier Coil	10.8M	FF17AMEB
1 3/4" x .099"	Diamond	Aluminum	-	0° Plastic Carrier Coil	9M	FF19AMEB
1 7/8" x .099"	Diamond	Aluminum	-	0° Plastic Carrier Coil	9M	FF20AMEB

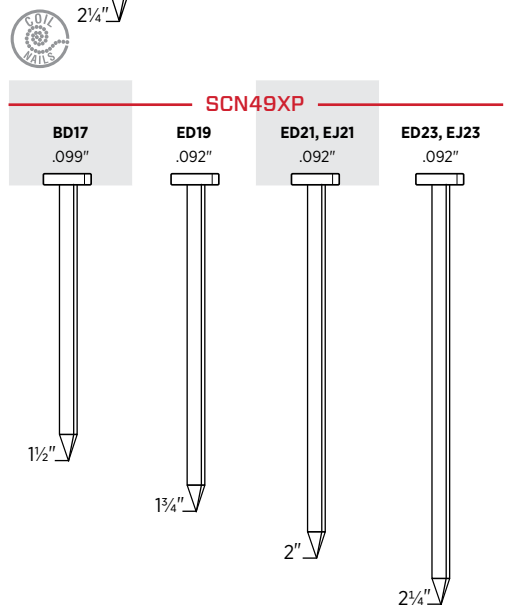

15° Smooth Shank Coil Nails

Siding, packaging, fencing, pallets and underlayment						
Length	Point	Finish	Coating	Collation	Box Count	Item Code
1 1/2" x .099"	Diamond	Bright	Sencote	15° Plastic Carrier Coil	6M	BD17APBC
1 3/4" x .092"	Diamond	Hot Dip	Sencote	15° Plastic Carrier Coil	3.6M	ED19ASBC
2" x .092"	Diamond	Galv	Sencote	15° Flat Wire Welded Coil	3.6M	ED21AABH
2" x .092"	Diamond	Exterior	Sencote	15° Flat Wire Welded Coil	3.6M	ED21ADBH
2" x .092"	Diamond	Exterior	Sencote	15° Flat Wire Welded Coil	7.2M	EJ21ADBH
2" x .092"	Diamond	Hot Dip	Sencote	15° Plastic Carrier Coil	3.6M	EJ21ASBC
2 1/4" x .092"	Diamond	Galv	Sencote	15° Flat Wire Welded Coil	3.6M	ED23AABH
2 1/4" x .092"	Diamond	Exterior	Sencote	15° Flat Wire Welded Coil	3.6M	ED23ADBH
2 1/4" x .092"	Diamond	Hot Dip	Sencote	15° Plastic Carrier Coil	3.6M	ED23ASBC
2 1/4" x .092"	Diamond	Exterior	Sencote	15° Conical Wire Welded Coil	7.2M	EJ23ADBH
2 1/4" x .092"	Diamond	Hot Dip	Sencote	15° Plastic Carrier Coil	3.6M	EJ23ASBC

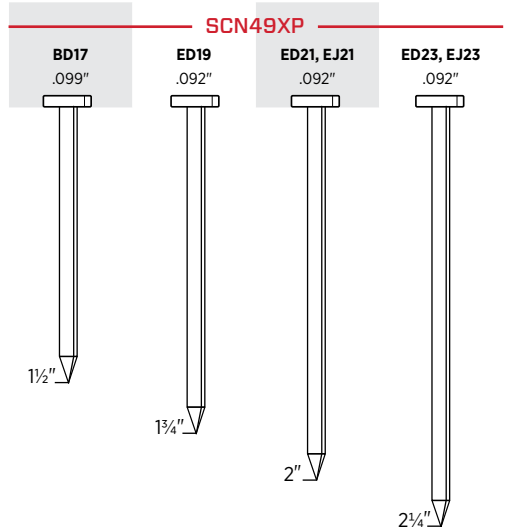

15° Ring Shank Coil Nails

Siding, packaging, fencing, wood shingles, crating and pallets						
Length	Point	Finish	Coating	Collation	Box Count	Item Code
1/4" x .082"	Diamond	Bright	Sencote	15° Conical Wire Welded Coil	15M	SE15APB
1/4" x .082"	Diamond	Bright	Sencote	15° Flat Wire Welded Coil	14M	SE15APBH
1/2" x .082"	Diamond	Bright	Sencote	15° Conical Wire Welded Coil	12M	SE17APB
1/2" x .082"	Diamond	Bright	Sencote	15° Flat Wire Welded Coil	11.2M	SE17APBH
3/4" x .082"	Diamond	Bright	Sencote	15° Conical Wire Welded Coil	12M	SE19APB
1/2" x .092"	Diamond	Exterior	Sencote	15° Flat Wire Welded Coil	9M	EL17ADBH
1/4" x .092"	Diamond	Hot Dip	Sencote	15° Plastic Carrier Coil	3.6M	EL19ASBC
1/4" x .092"	Diamond	Hot Dip	Sencote	15° Flat Wire Welded Coil	3.6M	EL19ASBH
1/8" x .092"	Diamond	Galv	Sencote	15° Flat Wire Welded Coil	3.6M	EL20AABH
1/8" x .092"	Diamond	Hot Dip	Sencote	15° Flat Wire Welded Coil	3.6M	EL20ASBH
2" x .092"	Diamond	Exterior	Sencote	15° Flat Wire Welded Coil	9M	EL21ADBH
2" x .092"	Diamond	Hot Dip	Sencote	15° Flat Wire Welded Coil	3.6M	EL21ASBH
2/4" x .092"	Diamond	Galv	Sencote	15° Flat Wire Welded Coil	3.6M	EL23AABH
2/4" x .092"	Diamond	Hot Dip	Sencote	15° Plastic Carrier Coil	3.6M	EL23ASBC
2/4" x .092"	Diamond	Hot Dip	Sencote	15° Flat Wire Welded Coil	3.6M	EL23ASBH
2/2" x .092"	Diamond	Hot Dip	—	15° Plastic Carrier Coil	3.6M	EL25ASEC
1/4" x .090"	Diamond	Stainless 304	—	15° Flat Wire Welded Coil	3.6M	EL15AGEH
1/2" x .090"	Diamond	Stainless 304	—	15° Flat Wire Welded Coil	3.6M	EL17AGEH
2/4" x .090"	Diamond	Stainless 304	—	15° Plastic Carrier Coil	3.6M	EL23AGEC
2/2" x .090"	Diamond	Stainless 304	—	15° Flat Wire Welded Coil	3.6M	EL25AGEH
1/4" x .092"	Diamond	Stainless 304	Sencote	15° Flat Wire Welded Coil	3.6M	EL19AGBH
1/8" x .092"	Diamond	Stainless 304	Sencote	15° Flat Wire Welded Coil	3.6M	EL20AGBH
2" x .092"	Diamond	Stainless 304	Sencote	15° Flat Wire Welded Coil	3.6M	EL21AGBH
2/4" x .092"	Diamond	Stainless 304	Sencote	15° Flat Wire Welded Coil	3.6M	EL23AGBH
2/2" x .092"	Diamond	Stainless 316	—	15° Flat Wire Welded Coil	3M	EL25AUEH
1/8" x .092"	Diamond	Aluminum	—	15° Plastic Carrier Coil	9M	FL20AMEC

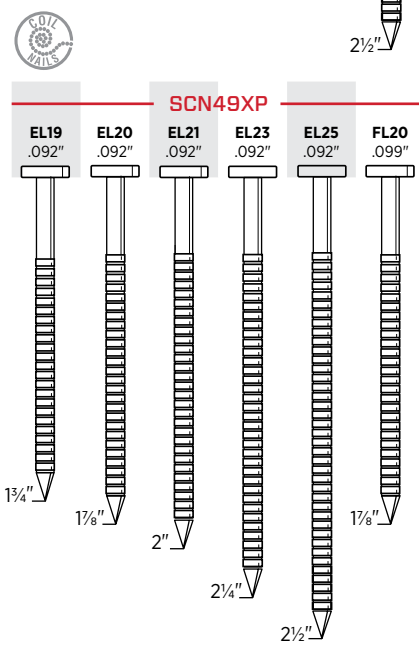
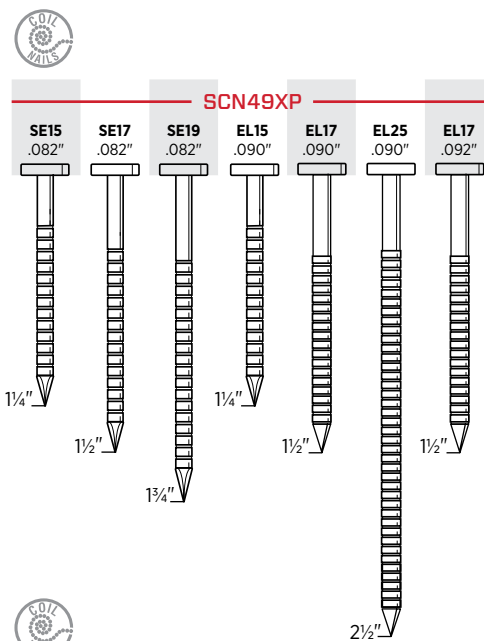

15° Screw Shank Coil Nails

Siding and fencing						
Length	Point	Finish	Coating	Collation	Box Count	Item Code
1/2" x .099"	Diamond	Aluminum	—	15° Plastic Carrier Coil	10.8M	FF17AMEC
1/4" x .099"	Diamond	Aluminum	—	15° Plastic Carrier Coil	9M	FF19AMEC
1/8" x .099"	Diamond	Aluminum	—	15° Plastic Carrier Coil	9M	FF20AMEC

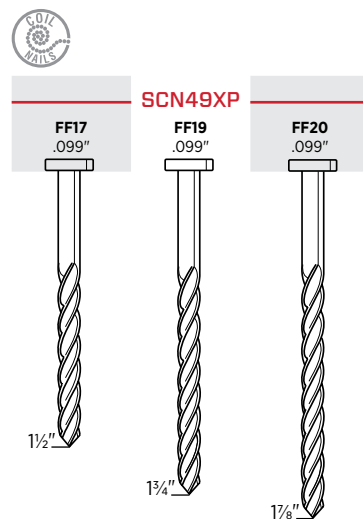

ROOFING, SIDING & FENCING FASTENERS

16^{GA}

1" Crown Heavy Wire Staples

Composite roofing, roofing felt, foam insulation board, house wrap, sheathing, corrugated containers, furniture/cabinets and butt joints

Length	Point	Finish	Coating	Collation	Box Count	Item Code
3/8"	Chisel	Galv	Plain	Glued	10M	P06BAA
1/2"	Chisel	Galv	Sencote	Taped	10M	P08BABT
5/8"	Chisel	Galv	Sencote	Taped	10M	P10BAB
5/8"	Divergent	Galv	Sencote	Glued	10M	P10FAB
5/8"	Chisel	Galv	Coated	Glued	10M	P10BPE
3/4"	Chisel	Galv	Sencote	Taped	10M	P11BAB
3/4"	Chisel	Galv	Coated	Glued	10M	P11BPE
7/8"	Chisel	Galv	Sencote	Taped	10M	P12BAB
1"	Chisel	Galv	Sencote	Taped	10M	P13BAB
1"	Chisel	Galv	Sencote	Glued	10M	P13BPE
1 1/4"	Chisel	Galv	Sencote	Taped	10M	P15BAB
1 1/4"	Chisel	Galv	Coated	Glued	10M	P15BPE
1 1/2"	Chisel	Galv	Sencote	Taped	10M	P17BAB
1"	Outside Chisel	Stainless 304	Sencote	Taped	5M	P13BGBN

*WC15ORXP Short Staples: order kit YK0786 to drive 3/8"-5/8" staples

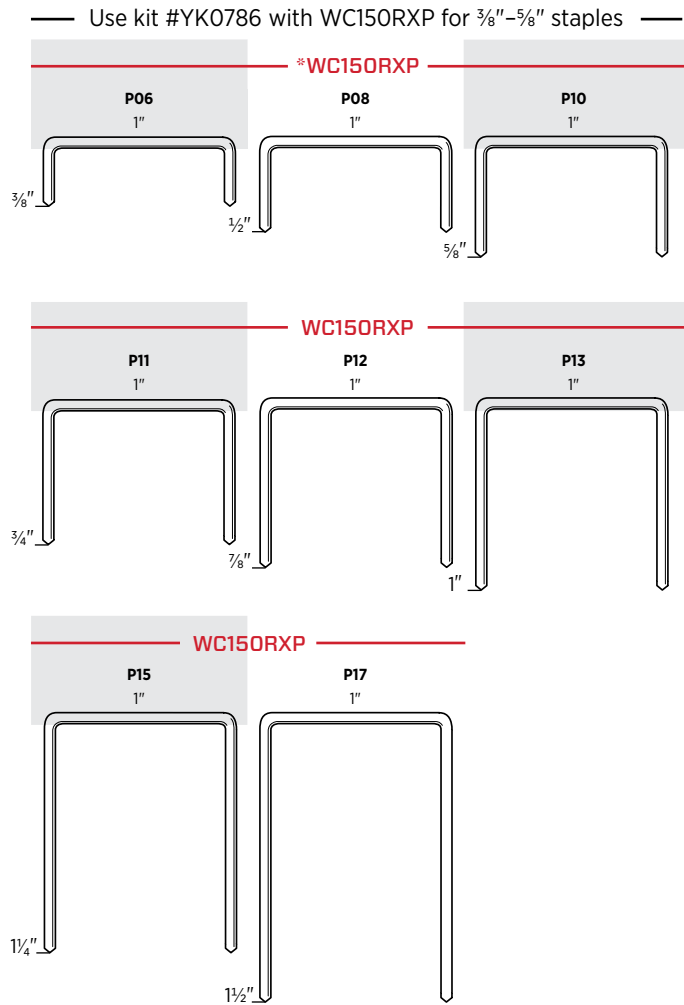

20^{GA}

7/16" Crown Fine Wire Staples

Roofing, insulation and vapor barriers

Length	Point	Finish	Coating	Collation	Box Count	Item Code
3/8"	Chisel	Galv	Plain	Glued	5M	H06BAA

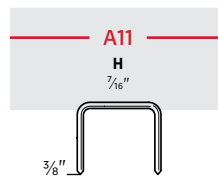

21^{GA}

1" Button Cap & 1/2" Crown Staples

Roof felt installation and house wrap

Length	Point	Finish	Coating	Collation	Box Count	Item Code
5/8"	Chisel	Galv	Plain	Glued	2.2M	M004092
1"	—	Plastic	—	Laser Weld	2.2M	—

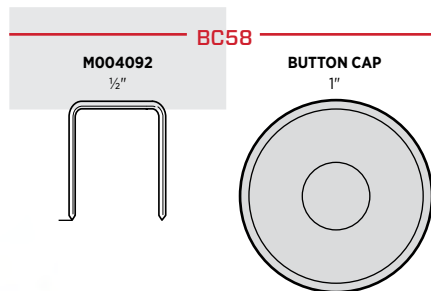

PALLETS & CRATING

THE DURABILITY TO DRIVE ALL DAY

SENCO's PalletPro™ heavy-duty coil nailers are built specifically for the challenges of pallets and crating. The PalletPro130 can drive fasteners as long as 5½" and hold up to 225 nails.

APPLICATIONS

Pallets, crates, heavy-duty framing and truss attachment

FEATURES

- Durable drivers and bumpers
- Flexible collation deflectors
- Dust guards for safe operation and extended use

Clinch and sisal anvil staple tools come in 18 and 20 gauge ½" and 7/16" crowns. Great for hand-held or mounted applications.

APPLICATIONS

Packaging, corrugated box fabrication, shoe making and bedding: basically any time two materials must be stapled and clinched together

FEATURES

- High-capacity magazines
- Extended reach capability
- Tool-free adjustable anvil opening
- Bottom-load magazines



PalletPro™57FXP

2¼" COIL NAILER

ITEM #4L0001N

15°



Features

- High load capacity
- Ultra-durability driver and piston bumper for long life
- Adjustable nail canister accommodates wide range of nails
- Body protection — side steel wear plates reduce abrasion of tool

PalletPro™100XP

4" COIL NAILER (SPECIAL ORDER TOOL)

ITEM #5L0001N

15°



Features

- High load capacity
- Includes optional heavy-duty threaded T-handle
- Flexible collation deflector and dust guard for improved safety in commercial environments
- Strengthened driver and bumper for extended use and reliable service

PalletPro™130XP

5½" COIL NAILER (SPECIAL ORDER TOOL)

ITEM #5M0001N

15°



Features

- High load capacity
- Includes optional heavy-duty threaded T-handle
- Flexible collation deflector and dust guard for improved safety in commercial environments
- Strengthened driver and bumper for extended use and reliable service

Product Reference Chart

TOOL SPECS	PalletPro™57XP	PalletPro™100XP	PalletPro™130XP
Trigger	Contact	Contact	Sequential
Operating Pressure	70-120 psi (4.9-8.4 bar)	70-120 psi (4.9-8.4 bar)	70-120 psi (4.9-8.4 bar)
Air Consumption (60 CPM)	3.07 scfm	11.4 scfm	11.4 scfm
Air Inlet	¾" NPT	¾" NPT	¾" NPT
Weight	5.9 lbs (2.67 kg)	11.5 lbs (5.24 kg)	13 lbs (5.9 kg)
Height	11.25" (286 mm)	16.5" (418 mm)	18" (457 mm)
Length	11.88" (302 mm)	13.25" (338 mm)	13" (330 mm)
Width	5.25" (123 mm)	6" (153 mm)	6.6" (168 mm)
Main Body Material	Aluminum	Aluminum	Aluminum
Warranty	5 yrs	5 yrs	5 yrs
FASTENER SPECS	Fasteners are located on pages 63-65		
Range	1"-2¼"	2¼"-4"	3"-5½"
Shank	.082"-.092"	.099"-.148"	.120"-.148"
Capacity	300-350	225-300	120-225
Angle/Collation	15° Flat Wire Welded Coil	15° Flat Wire Welded Coil	15° Flat Wire Welded Coil
Series	BK, ED, EJ, EL, SE	BE, BK, BL, BT, HK, GD, GL, HD, HL, KD	HD, HK, HL, KD, MD
TOOL FEATURES			
Tool-Free Jam Clearing	Yes	Yes	Yes
Depth-of-Drive	No	No	No
Debris Shield	Yes	Yes	Yes

DFPXP

20 Ga. 1/2" CROWN, 1/2" STAPLE
CLINCH TOOL

ITEM #8H0001N

20_{GA}



Features

- High-capacity magazine — less reloading means greater productivity
- Tool-free adjustable anvil opening
- Rubber comfort grip reduces vibration, slipping and fatigue
- Bottom-load magazine for quick reloading
- 6.9" throat allows for extended reach into cartons

F75LXP

18 Ga. 7/16" CROWN, 5/8" STAPLE
CLINCH TOOL

ITEM #8J0002N

18_{GA}



Features

- High-capacity magazine — less reloading means greater productivity
- Tool-free adjustable anvil opening
- Rubber comfort grip reduces vibration, slipping and fatigue
- Bottom-load magazine for quick reloading
- 6.9" throat allows for extended reach into cartons

F75SXP

18 Ga. 7/16" CROWN, 5/8" STAPLE
SISAL ANVIL

ITEM #8J0001N

18_{GA}



Features

- High-capacity magazine — less reloading means greater productivity
- Tool-free adjustable anvil opening
- Rubber comfort grip reduces vibration, slipping and fatigue
- Bottom-load magazine for quick reloading

Product Reference Chart

TOOL SPECS	DFPXP	F75LXP	F75SXP
Trigger	Sequential	Sequential	Sequential
Operating Pressure	65-100 psi (4-7 bar)	65-100 psi (4-7 bar)	65-100 psi (4-7 bar)
Air Consumption (60 CPM)	.7 scfm	.7 scfm	.8 scfm
Air Inlet	1/4" NPT	1/4" NPT	1/4" NPT
Weight	4.9 lbs (2.24 kg)	4.9 lbs (2.24 kg)	4.9 lbs (2.24 kg)
Height	12.9" (327 mm)	12.9" (327 mm)	12.9" (327 mm)
Length	14.9" (380 mm)	14.9" (380 mm)	14.9" (380 mm)
Width	3" (75 mm)	3" (75 mm)	3" (75 mm)
Main Body Material	Aluminum	Aluminum	Aluminum
Warranty	5 yrs	5 yrs	5 yrs
FASTENER SPECS	Fasteners are located on pages 63-65		
Gauge	20	18	18
Crown	1/2"	7/16"	7/16"
Range	5/16" - 5/8"	5/16" - 5/8"	5/16" - 5/8"
Capacity	230	152	152
Angle/Collation	Straight Glued Strip	Straight Glued Strip	Straight Glued Strip
Series	F	J	J
TOOL FEATURES			
Tool-Free Adjustable Anvil Opening	Yes	Yes	Yes
Bottom-Load Magazine	Yes	Yes	Yes
Extended Reach Capability	Yes	Yes	No

PALLETS & CRATING FASTENERS

15° Smooth Shank Coil Nails

Pallets, crates, fencing, siding and underlayment						
Length	Point	Finish	Coating	Collation	Box Count	Item Code
2" x .092"	Diamond	Galv	Sencote	15° Flat Wire Welded Coil	3.6M	ED21AABH
2" x .092"	Diamond	Exterior	Sencote	15° Flat Wire Welded Coil	3.6M	ED21ADBH
2" x .092"	Diamond	Exterior	Sencote	15° Flat Wire Welded Coil	7.2M	EJ21ADBH
2 1/4" x .092"	Diamond	Galv	Sencote	15° Flat Wire Welded Coil	3.6M	ED23AABH
2 1/4" x .092"	Diamond	Exterior	Sencote	15° Flat Wire Welded Coil	3.6M	ED23ADBH

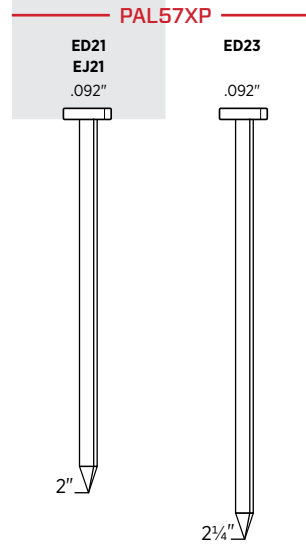

15° Ring Shank Coil Nails

Pallets, crates, fencing, wood shingles, siding and underlayment						
Length	Point	Finish	Coating	Collation	Box Count	Item Code
1 1/4" x .082"	Diamond	Bright	Sencote	15° Flat Wire Welded Coil	14M	SE15APBH
1 1/2" x .082"	Diamond	Bright	Sencote	15° Flat Wire Welded Coil	11.2M	SE17APBH
1 1/2" x .092"	Diamond	Exterior	Sencote	15° Flat Wire Welded Coil	9M	EL17ADBH
1 3/4" x .092"	Diamond	Hot Dip	Sencote	15° Flat Wire Welded Coil	3.6M	EL19ASBH
1 7/8" x .092"	Diamond	Galv	Sencote	15° Flat Wire Welded Coil	3.6M	EL20AABH
1 7/8" x .092"	Diamond	Hot Dip	Sencote	15° Flat Wire Welded Coil	3.6M	EL20ASBH
2" x .092"	Diamond	Exterior	Sencote	15° Flat Wire Welded Coil	9M	EL21ADBH
2" x .092"	Diamond	Hot Dip	Sencote	15° Flat Wire Welded Coil	3.6M	EL21ASBH
2 1/4" x .092"	Diamond	Galv	Sencote	15° Flat Wire Welded Coil	3.6M	EL23AABH
2 1/4" x .092"	Diamond	Hot Dip	Sencote	15° Flat Wire Welded Coil	3.6M	EL23ASBH
1 3/4" x .092"	Diamond	Stainless 304	Sencote	15° Flat Wire Welded Coil	3.6M	EL19AGBH
1 7/8" x .092"	Diamond	Stainless 304	Sencote	15° Flat Wire Welded Coil	3.6M	EL20AGBH
2" x .092"	Diamond	Stainless 304	Sencote	15° Flat Wire Welded Coil	3.6M	EL21AGBH
2 1/4" x .092"	Diamond	Stainless 304	Sencote	15° Flat Wire Welded Coil	3.6M	EL23AGBH

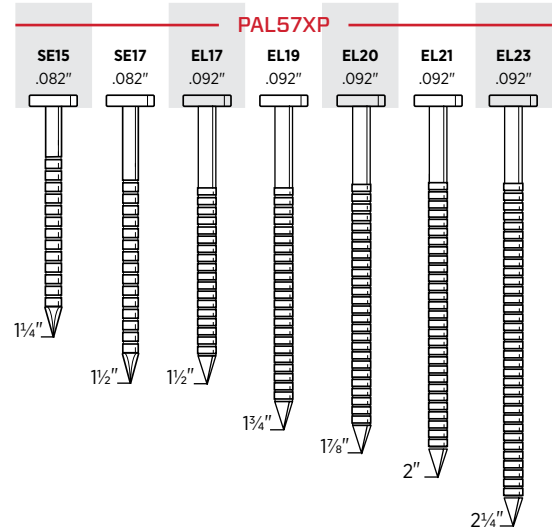

15° Smooth Shank Coil Nails

Pallets, framing, sheathing, subfloor, decks and trusses						
Length	Point	Finish	Coating	Collation	Box Count	Item Code
2" x .113"	Diamond	Bright	Sencote	15° Flat Wire Welded Coil	6M	GD21APBF
2 3/8" x .113"	Diamond	Bright	Sencote	15° Flat Wire Welded Coil	6M	GD24APBF
2 1/2" x .113"	Diamond	Bright	Sencote	15° Flat Wire Welded Coil	6M	GD25APBF
2 1/2" x .131"	Diamond	Bright	Sencote	15° Flat Wire Welded Coil	3.6M	KD25APBF
3" x .120"	Diamond	Bright	Sencote	15° Flat Wire Welded Coil	4M	HD27APBF
3" x .131"	Diamond	Bright	Sencote	15° Flat Wire Welded Coil	3.6M	KD27APBF
3 1/4" x .120"	Diamond	Bright	Sencote	15° Flat Wire Welded Coil	4M	HD28APBF
3 1/4" x .131"	Diamond	Bright	Sencote	15° Flat Wire Welded Coil	3.6M	KD28APBF
3 1/2" x .131"	Diamond	Bright	Sencote	15° Flat Wire Welded Coil	3.6M	KD29APBF
5" x .148"	Diamond	Bright	Sencote	15° Flat Wire Welded Coil	1.8M	MD34APBF
2" x .113"	Diamond	Galv	Sencote	15° Flat Wire Welded Coil	6M	GD21AABF
2 1/2" x .113"	Diamond	Galv	Sencote	15° Flat Wire Welded Coil	6M	GD25AABF
3" x .131"	Diamond	Galv	Sencote	15° Flat Wire Welded Coil	3.6M	KD27AABF
3" x .131"	Diamond	Hot Dip	Sencote	15° Flat Wire Welded Coil	2.4M	KD27ASBF
3 1/4" x .131"	Diamond	Galv	Sencote	15° Flat Wire Welded Coil	3.6M	KD28AABF
3 1/4" x .131"	Diamond	Hot Dip	Sencote	15° Flat Wire Welded Coil	2.4M	KD28ASBF

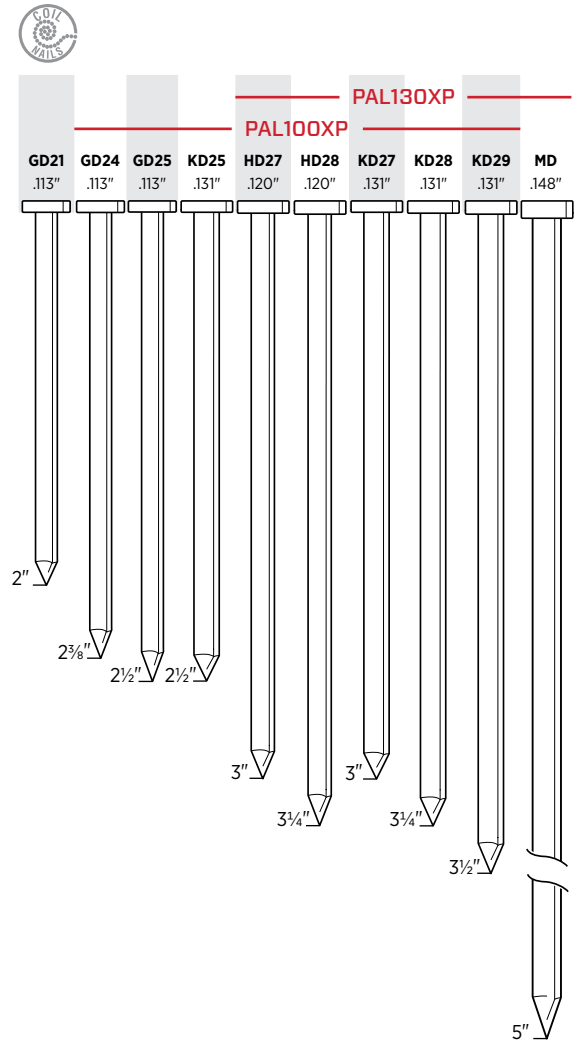

15° Ring Shank Coil Nails

Pallets, framing, sheathing, subfloor, decks and trusses						
Length	Point	Finish	Coating	Collation	Box Count	Item Code
2" x .099"	Diamond	Bright	Sencote	15° Flat Wire Welded Coil	6.6M	BL21APBF
2" x .099"	Diamond	Bright	Sencote	15° Flat Wire Welded Coil	6.6M	BT21APBF
2" x .113"	Diamond	Bright	Sencote	15° Flat Wire Welded Coil	6M	GL21APBF
2 1/4" x .099"	Diamond	Bright	Sencote	15° Flat Wire Welded Coil	6.6M	BL23APBF
2 3/8" x .113"	Diamond	Bright	Sencote	15° Flat Wire Welded Coil	6M	GL24APBF
2 1/4" x .099"	Diamond	Galv	Sencote	15° Flat Wire Welded Coil	6.6M	BE23AABF
2 3/8" x .113"	Diamond	Galv	Sencote	15° Flat Wire Welded Coil	6M	GL24AABF
2 3/8" x .113"	Diamond	Hot Dip	Sencote	15° Flat Wire Welded Coil	2.7M	GL24ASBF
3" x .120"	Diamond	Galv	Sencote	15° Flat Wire Welded Coil	3.6M	HL27AABF
3" x .120"	Diamond	Hot Dip	Sencote	15° Flat Wire Welded Coil	2.4M	HL27ASBF
2 3/8" x .113"	Diamond	Stainless 304	Sencote	15° Flat Wire Welded Coil	2.7M	GL24AGBF
3" x .120"	Diamond	Stainless 304	Sencote	15° Flat Wire Welded Coil	2.4M	HL27AGBF

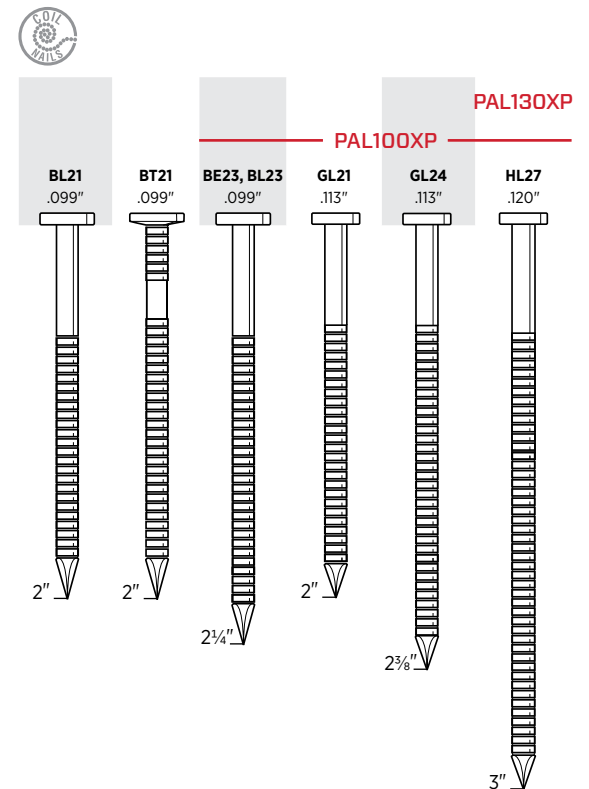

PALLETS & CRATING FASTENERS

15° Screw Shank Coil Nails

Pallets, framing, sheathing, subfloor, decks and trusses

Length	Point	Finish	Coating	Collation	Box Count	Item Code
2" x .099"	Blunt Dia.	Bright	Sencote	15° Flat Wire Welded Coil	9M	BK21BPBFN
2" x .099"	Chisel	Bright	Sencote	15° Flat Wire Welded Coil	6.6M	BK21EPBF
2¼" x .099"	Blunt Dia.	Bright	Sencote	15° Flat Wire Welded Coil	9M	BK23BPBFN
2¼" x .099"	Chisel	Bright	Sencote	15° Flat Wire Welded Coil	6.6M	BK23EPBF
2½" x .099"	Blunt Dia.	Bright	Sencote	15° Flat Wire Welded Coil	6M	BK25BPBFN
3" x .120"	Diamond	Bright	Sencote	15° Flat Wire Welded Coil	4M	HK27APBFN

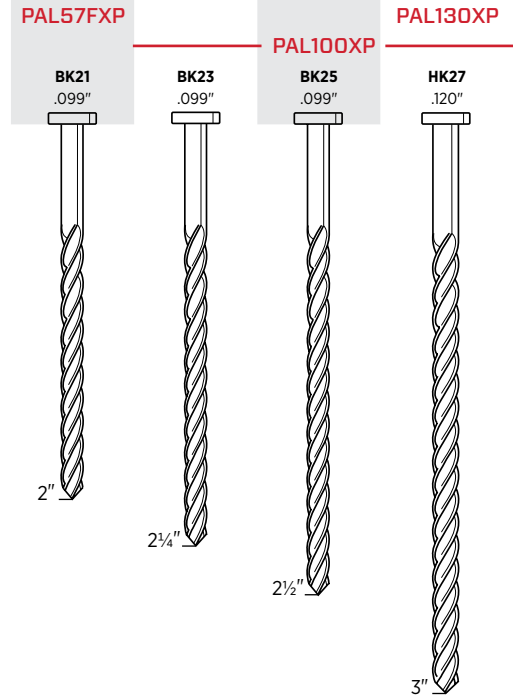

20^{GA} ½" Crown Fine Wire Staples

Packaging, set-up boxes and bedding

Length	Point	Finish	Coating	Collation	Box Count	Item Code
⅝"	Chisel	Galv	Sencote	Glued Strip	24M	F05BAAP
⅜"	Chisel	Galv	Sencote	Glued Strip	10M	F06BAA
⅜"	Chisel	Galv	Sencote	Glued Strip	24M	F06BAAP
½"	Chisel	Galv	Sencote	Glued Strip	10M	F08BAAN
½"	Chisel	Galv	Sencote	Glued Strip	15M	F08BAAP
⅜"	Chisel	Stainless 304	Sencote	Glued Strip	10M	F06BGA
½"	Chisel	Stainless 304	Sencote	Glued Strip	10M	F08BGA

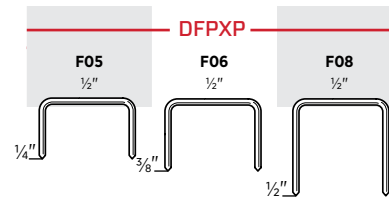

18^{GA} 7/16" Crown Fine Wire Staples

For assembling packaging and joining corrugated materials

Length	Point	Finish	Coating	Collation	Box Count	Item Code
⅜"	Chisel	Galv	Plain	Glued Strip	5M	J06BAA
½"	Chisel	Galv	Plain	Glued Strip	5M	J08BAAN
⅝"	Chisel	Galv	Plain	Glued Strip	5M	J10BAAN

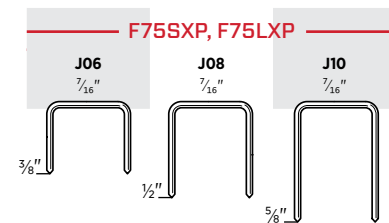

UPHOLSTERY & FURNITURE

SENCO HAS YOU COVERED. SINCE 1948.

SENCO offers a range of fine and medium wire staplers for upholstery and furniture assembly. Our upholstery staplers are the most customizable in the industry, with long nosepieces, extended magazines and a wide range of fasteners for any project.

APPLICATIONS

Upholstery, furniture assembly, cabinets, bedding, picture frames, molding, roof felt, house wrap, RV construction

FEATURES

- Lightweight
- Ergonomic
- Variety of configurations



SFT10XP FAMILY

3/16", 3/8", 7/16", 1/2" CROWN,
5/8" FINE WIRE STAPLERS

SFT10XP

22_{GA}

20_{GA}



Features

- Heavy-duty steel cap
- Short trigger stroke
- Rear exhaust keeps oil off fabric
- Automatic models have adjustable speed triggers

Models and Item Numbers

Crown	Ga	Staple	Description	Item Code
3/16"	22	A/D Wire	Standard	6S0001N
3/16"	22	A/D Wire	Auto	6S0101N
1/2"	22	B Wire	Standard	6S0011N
3/8"	22	C Wire	Standard	6S0021N
3/8"	22	C Wire	Auto	6S0121N
3/16"	20	E Wire	Standard	6S0031N
1/2"	20	F Wire	Standard	6S0041N
3/8"	20	G Wire	Standard	6S0051N

SFT10XP FAMILY

3/16", 3/8", 7/16", 1/2" CROWN,
5/8" FINE WIRE STAPLERS

DOUBLE LENGTH MAGAZINE

22_{GA}

20_{GA}



Features

- Heavy-duty steel cap
- Short trigger stroke
- Rear exhaust keeps oil off fabric
- Automatic models have adjustable speed triggers

Models and Item Numbers

Crown	Ga	Staple	Description	Item Code
1/2"	22	B Wire	Standard	6S0211N
1/2"	22	B Wire	Auto	6S0311N
3/8"	22	C Wire	Standard	6S0221N
3/8"	22	C Wire	Auto	6S0321N
1/2"	20	F Wire	Auto	6S0341N
3/8"	20	G Wire	Standard	6S0251N
3/8"	20	G Wire	Auto	6S0351N
7/16"	20	H Wire	Auto	6S0361N

SFT10XP FAMILY

3/16", 3/8", 7/16", 1/2" CROWN,
5/8" FINE WIRE STAPLERS

LONG NOSE

22_{GA}



Features

- Heavy-duty steel cap
- Short trigger stroke
- Rear exhaust keeps oil off fabric
- Automatic models have adjustable speed triggers

Models and Item Numbers

Crown	Ga	Staple	Description	Item Code
3/8"	22	C Wire	Standard	6S0421N

Product Reference Chart

TOOL SPECS	SFT10XP
Trigger	Sequential, Auto
Operating Pressure	60-95 psi (4.1-6.5 bar)
Air Consumption (60 CPM)	.77 scfm
Air Inlet	1/4" NPT
Weight	2.1 lbs (0.955 kg)
Height	6.57" (167 mm)
Length	8.58" (218 mm)
Width	1.65" (42 mm)
Main Body Material	Aluminum
Warranty	5 yrs
FASTENER SPECS	Fasteners are located on pages 69-71
Gauge	22, 20
Crown	3/16", 3/8", 7/16", 1/2"
Range	1/4"-5/8"
Capacity	110-92
Angle/Collation	Straight Glued Strip
Series	A, B, C, D, E, F, G, H



Stapling Upholstery for Over 60 Years

SENCO® offers 18 configurations of upholstery staplers and over 40 combinations of staple length, crown and gauge.

SFW09

3/8" CROWN, 5/8" FINE WIRE STAPLER

ITEM #4C0001N

22_{GA}



Features

- Rear exhaust keeps oil off fabric
- Full 1" lip length
- Rear magazine bumper protects fabric
- Rounded steel cap won't snag fabric

SNS200XP-BST

7/16" CROWN, HEAVY WIRE STAPLER

ITEM #7C0001N

17_{GA}

16_{GA}



Features

- Innovative magazine-removal mechanism maintains a clean, narrow line of sight for precise staple placement
- 1" lip length allows access to tight corners
- Durable all-metal magazine construction
- Precision-machined drive track ensures accurate, jam-free staple drives

The SNS200XP-BST is the Benchmark Stapler for the Furniture Industry.

- 20% more powerful than all other staplers in its class to handle the toughest engineered woods.
- Drives both 16 and 17 gauge, 7/16" crown staples (1" to 2" in length).
- Combination of class-leading power, durability and ergonomics makes it an unrivaled professional tool.



Product Reference Chart

TOOL SPECS	SFW09	SNS200XP-BST
Trigger	Dual	Contact
Operating Pressure	60-95 psi (4.1-6.5 bar)	70-120 psi (4.8-8.3 bar)
Air Consumption (60 CPM)	.77 scfm	5.52 scfm
Air Inlet	1/4" NPT	3/8" NPT
Weight	2.1 lbs (0.955 kg)	5.9 lbs (2.67 kg)
Height	6" (152 mm)	11" (279 mm)
Length	9.25" (235 mm)	14" (356 mm)
Width	1.63" (41 mm)	4" (102 mm)
Main Body Material	Aluminum	Aluminum
Warranty	5 yrs	5 yrs
FASTENER SPECS	Fasteners are located on pages 69-71	
Gauge	22	17 (O-Wire), 16 (N-Wire)
Crown	3/8"	7/16"
Range	5/32"-5/8"	1"-2"
Capacity	110-168	160
Angle/Collation	Straight Glued Strip	Straight Glued/Taped Strip
Series	C	N, O

UPHOLSTERY & FURNITURE FASTENERS

22^{GA} 3/16" Crown Fine Wire Staples

Furniture upholstery, felt, insulation, casebacks, screening and shoes						
Length	Point	Finish	Coating	Collation	Box Count	Item Code
1/4"	Chisel	Galv	Sencote	Straight Glued Strip	10M	A04BAAN
3/8"	Chisel	Galv	Sencote	Straight Glued Strip	30M	A06BABN
3/8"	Chisel	Galv	Sencote	Straight Glued Strip	40M	A06BABP
1/2"	Chisel	Galv	Sencote	Straight Glued Strip	20M	A08BAB
1/2"	Chisel	Galv	Sencote	Straight Glued Strip	30M	A08BABP
5/8"	Chisel	Galv	Sencote	Straight Glued Strip	20M	D10BABN
5/8"	Chisel	Galv	Sencote	Straight Glued Strip	23M	D10BABPN

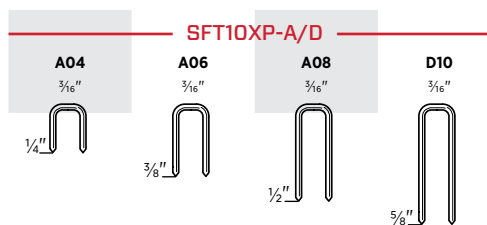

22^{GA} 1/2" Crown Fine Wire Staples

Furniture upholstery, felt, insulation, casebacks, screening and shoes						
Length	Point	Finish	Coating	Collation	Box Count	Item Code
1/4"	Chisel	Galv	Plain	Straight Glued Strip	25M	B04BAAPN
5/16"	Chisel	Galv	Plain	Straight Glued Strip	45M	B05BAAP
5/16"	Outside Chisel	Galv	Plain	Straight Glued Strip	9M	B05DAA
3/8"	Chisel	Galv	Plain	Straight Glued Strip	40M	B06BAAP
1/2"	Chisel	Galv	Plain	Straight Glued Strip	25M	B08BAAP

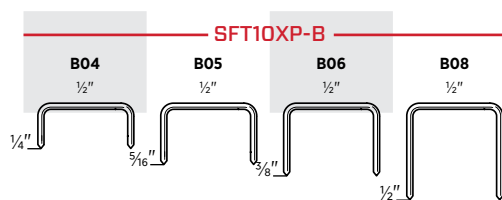

22^{GA} 3/8" Crown Fine Wire Staples

Furniture upholstery, felt, insulation, casebacks, screening and shoes						
Length	Point	Finish	Coating	Collation	Box Count	Item Code
5/32"	Chisel	Galv	Plain	Straight Glued Strip	60M	C02BAAPN
3/16"	Chisel	Galv	Plain	Straight Glued Strip	55M	C03BAAPN
1/4"	Chisel	Galv	Plain	Straight Glued Strip	35M	C04BAAP
5/16"	Chisel	Galv	Plain	Straight Glued Strip	28M	C05BAAPN
3/8"	Chisel	Galv	Plain	Straight Glued Strip	50M	C06BAAP
7/16"	Chisel	Galv	Plain	Straight Glued Strip	40M	C07BAAPN
1/2"	Chisel	Galv	Plain	Straight Glued Strip	35M	C08BAAP
5/8"	Chisel	Galv	Plain	Straight Glued Strip	27M	C10BAAP
3/16"	Chisel	Stainless 304	Plain	Straight Glued Strip	25M	C03BGAN
1/4"	Chisel	Stainless 304	Plain	Straight Glued Strip	25M	C04BGAN
3/8"	Chisel	Stainless 304*	Plain	Straight Glued Strip	10M	C06BHA
3/8"	Chisel	Stainless 304	Plain	Straight Glued Strip	10M	C06BGA

* High-Tensile 304 Stainless Steel

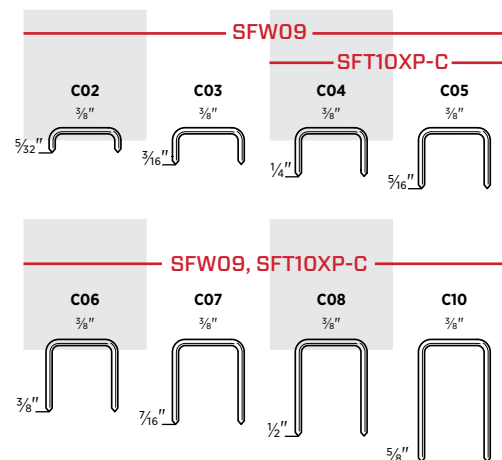

21^{GA} 3/16" Crown Fine Wire Staples

Furniture upholstery, felt, insulation, casebacks, screening and shoes						
Length	Point	Finish	Coating	Collation	Box Count	Item Code
5/8"	Chisel	Galv	Sencote	Straight Glued Strip	10M	W10BAB
3/4"	Chisel	Galv	Sencote	Straight Glued Strip	10M	W11BABN

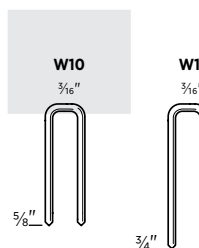

UPHOLSTERY & FURNITURE FASTENERS

20^{GA} 3/16" Crown Fine Wire Staples

Furniture upholstery, felt, insulation, casebacks, screening and shoes

Length	Point	Finish	Coating	Collation	Box Count	Item Code
3/8"	Chisel	Galv	Plain	Straight Glued Strip	10M	E06BAA
1/2"	Chisel	Galv	Plain	Straight Glued Strip	10M	E08BAA
5/8"	Chisel	Galv	Plain	Straight Glued Strip	5M	E10BAA

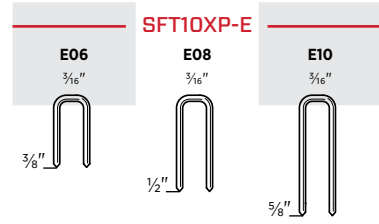

20^{GA} 1/2" Crown Fine Wire Staples

Upholstery, felt, insulation and casebacks

Length	Point	Finish	Coating	Collation	Box Count	Item Code
1/4"	Chisel	Galv	Plain	Straight Glued Strip	10M	F04BAAN
1/4"	Chisel	Galv	Plain	Straight Glued Strip	17M	F04BAAP
5/16"	Chisel	Galv	Plain	Straight Glued Strip	24M	F05BAAP
3/8"	Chisel	Galv	Plain	Straight Glued Strip	10M	F06BAA
3/8"	Chisel	Galv	Plain	Straight Glued Strip	24M	F06BAAP
1/2"	Chisel	Galv	Plain	Straight Glued Strip	10M	F08BAAN
1/2"	Chisel	Galv	Plain	Straight Glued Strip	15M	F08BAAP
3/8"	Chisel	Stainless 304	Plain	Straight Glued Strip	10M	F06BGA
1/2"	Chisel	Stainless 304	Plain	Straight Glued Strip	10M	F08BGA

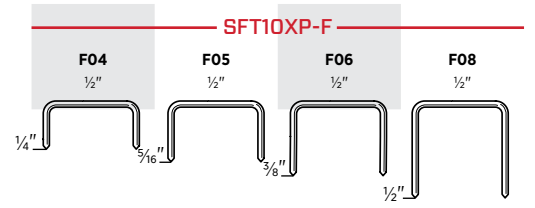

20^{GA} 3/8" Crown Fine Wire Staples

Upholstery, felt, insulation and casebacks

Length	Point	Finish	Coating	Collation	Box Count	Item Code
1/4"	Chisel	Galv	Plain	Straight Glued Strip	10M	G04BAAN
3/8"	Chisel	Galv	Plain	Straight Glued Strip	5M	G06BABN
1/2"	Chisel	Galv	Plain	Straight Glued Strip	5M	G08BAB
5/8"	Chisel	Galv	Plain	Straight Glued Strip	5M	G10BAB

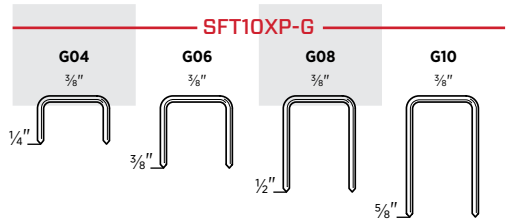

20^{GA} 7/16" Crown Fine Wire Staples

Upholstery, felt, insulation and casebacks

Length	Point	Finish	Coating	Collation	Box Count	Item Code
3/8"	Chisel	Galv	Plain	Straight Glued Strip	5M	H06BAA



UPHOLSTERY & FURNITURE FASTENERS

17^{GA}

7/16" Crown Heavy Wire Staples*

Furniture frames and crates						
Length	Point	Finish	Coating	Collation	Box Count	Item Code
1/4"	Chisel	Bright	Sencote	Glued	10M	O15BRBB
1/8"	Chisel	Bright	Sencote	Glued	10M	O16BRBB
1/2"	Chisel	Bright	Sencote	Glued	10M	O17BRBB
1/8"	Chisel	Bright	Sencote	Glued	10M	O18BRBB
1/4"	Chisel	Bright	Sencote	Glued	10M	O19BRBB

*Compatible with SNS200XP, SNS200XP-BST, SNS41 staplers manufactured after 09/2010. SNS44XP and SNS45XP staplers manufactured after 05/2010. For older tools, order upgrade kits SNS41-YK0794, SNS44-YK0793, SNS45-FA0186.

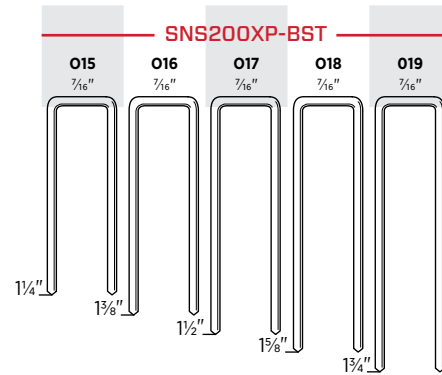

16^{GA}

7/16" Crown Heavy Wire Staples

Cabinets, casebacks, drawers and upholstery						
Length	Point	Finish	Coating	Collation	Box Count	Item Code
3/4"	Chisel	Bright	Sencote	Glued	5M	N11BRB
1"	Chisel	Bright	Sencote	Glued	5M	N13BRB
1 1/8"	Chisel	Bright	Sencote	Taped	10M	N14BRB
1 1/4"	Chisel	Bright	Sencote	Taped	10M	N15BRB
1 3/8"	Chisel	Bright	Sencote	Taped	10M	N16BRB
1 3/8"	Step	Bright	Sencote	Glued	10M	N16RRB
1 1/2"	Chisel	Bright	Sencote	Taped	10M	N17BRB
1 5/8"	Chisel	Bright	Sencote	Taped	10M	N18BRB
1 3/4"	Chisel	Bright	Sencote	Taped	10M	N19BRB
2"	Chisel	Bright	Sencote	Taped	10M	N21BRB
1/2"	Chisel	Galv	Sencote	Glued	5M	N08BABN
1/2"	Chisel	Galv*	Sencote	Glued	5M	N08BBBN
1/2"	Diverg	Galv*	Sencote	Glued	5M	N08FBB
5/8"	Chisel	Galv	Sencote	Glued	5M	N10BAB
3/4"	Chisel	Galv	Sencote	Glued	5M	N11BAB
3/4"	Diverg	Galv*	Sencote	Glued	5M	N11FBB
7/8"	Chisel	Galv	Sencote	Glued	5M	N12BABN
7/8"	Diverg	Galv	Sencote	Glued	5M	N12FABN
1"	Chisel	Galv	Sencote	Glued	5M	N13BAB
1"	Diverg	Galv	Sencote	Glued	5M	N13FAB
1 1/8"	Chisel	Galv	Sencote	Taped	10M	N14BAB
1 1/8"	Diverg	Galv	Sencote	Glued	10M	N14FAB
1 1/4"	Chisel	Galv	Sencote	Taped	10M	N15BAB
1 1/4"	Diverg	Galv	Sencote	Glued	10M	N15FAB
1 3/8"	Chisel	Galv	Sencote	Taped	10M	N16BAB
1 1/2"	Chisel	Galv	Sencote	Taped	10M	N17BAB
1 1/2"	Chisel	Galv	Sencote	Glued	10M	N17BPE
1 5/8"	Chisel	Galv	Sencote	Glued	10M	N18BAB
1 3/4"	Chisel	Galv	Sencote	Taped	10M	N19BAB
1 3/4"	Chisel	Galv	Sencote	Glued	10M	N19BPE
2"	Chisel	Galv	Sencote	Taped	10M	N21BAB
2"	Chisel	Galv	Sencote	Glued	10M	N21BPE
1 1/4"	Chisel	Stainless 304	Sencote	Glued	3M	N15BGB
1 1/2"	Chisel	Stainless 304	Sencote	Glued	3M	N17BGB
1 3/4"	Chisel	Stainless 304	Sencote	Glued	3M	N19BGBN
2"	Chisel	Stainless 304	Sencote	Glued	3M	N21BGBN

*Galvanized High-Tensile Steel

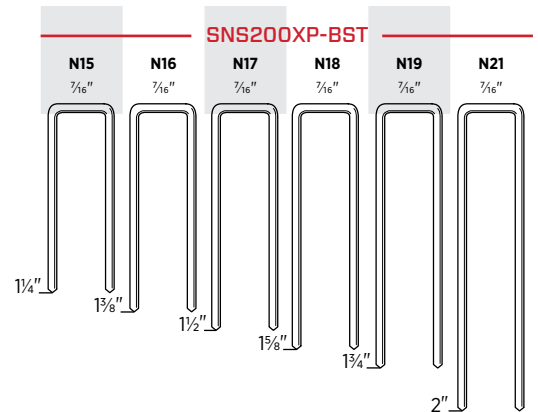
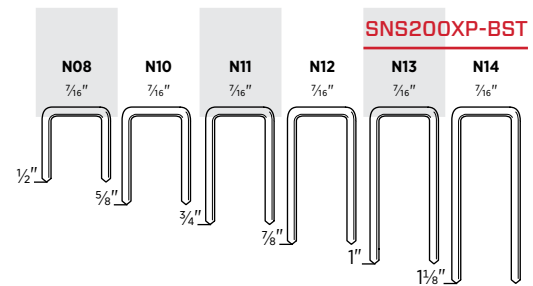

FLOORING

HARDWOOD FLOORING DONE RIGHT

Hardwood floors aren't so hard to install with our SHF200 and SHFS200 stand-up flooring tools. With long, ergonomic handles and bases that easily adjust to any floor thickness, you will get your job done in no time. SENCO is committed to creating industry-leading flooring tools to make your job easier.



SHF200

2" PNEUMATIC MALLET ACTUATED
HARDWOOD FLOORING CLEAT NAILER

ITEM #8D0001N

16_{GA}



Features

- Innovative non-marring base that adjusts between 1/2" and 3/4" flooring without the use of tools
- Safety trigger prevents accidental ejection of fasteners
- Lightweight and well balanced, yet 5% more powerful than competitive flooring nailers
- Extra-long ergonomic handle reduces user fatigue

SHFS200

2" PNEUMATIC MALLET ACTUATED
HARDWOOD FLOORING STAPLER

ITEM #8D0002N

15.5_{GA}



Features

- Innovative non-marring base that adjusts between 1/2" and 3/4" flooring without the use of tools
- Safety trigger prevents accidental ejection of fasteners
- Lightweight and well balanced, yet 5% more powerful than competitive flooring nailers
- Extra-long ergonomic handle reduces user fatigue

SLS20XP-HF

3/16" CROWN, 1" ENGINEERED &
HARDWOOD FLOOR STAPLER

ITEM #490021N

19_{GA}



Features

- Never-Lube® design – no oil required
- Front block easily adjusts to floor thickness
- Industry-exclusive safety controls staple placement
- Power-adjusted motor drives staples to consistent and controllable depth

Product Reference Chart

TOOL SPECS	SHF200	SHFS200	SLS20XP-HF
Trigger	Sequential	Sequential	Sequential
Operating Pressure	90-110 psi (6.2-7.6 bar)	90-110 psi (6.2-7.6 bar)	70-120 psi (4.8-8.3 bar)
Air Consumption (60 CPM)	2.52 scfm	2.52 scfm	1.92 scfm
Air Inlet	1/4" NPT	1/4" NPT	1/4" NPT
Weight	10.1 lbs (4.58 kg)	11.1 lbs (5.0 kg)	3.2 lbs (1.5 kg)
Height	21.5" (546 mm)	21.5" (546 mm)	9" (228 mm)
Length	17.8" (452 mm)	17.8" (452 mm)	13" (332 mm)
Width	3.1" (78 mm)	3.1" (78 mm)	3" (76 mm)
Main Body Material	Aluminum	Aluminum	Aluminum
Warranty	5 yrs	5 yrs	5 yrs
FASTENER SPECS	Fasteners are located on page 74		
Gauge	16	15.5	19
Crown	L-Head	1/2"	3/16"
Range	1 1/2"-2"	1"-2"	5/8"-1"
Capacity	107	102	168
Angled/Collation	Straight Glued Strip	Straight Glued Strip	Straight Glued Strip
Series	RW	FL	R
FLOORING MATERIAL			
Hardwood	Yes	Yes	Yes
Hardwood Laminate	Yes	Yes	Yes
Board Thickness	1/2", 5/8", 3/4", 33/32" (12-26 mm)	1/2", 5/8", 3/4" (12-19 mm)	1/4", 5/16", 3/8" (6-10 mm)

16^{GA}

L-Head Flooring Cleat Nails

1/2", 5/8", 3/4", 33/32" Solid hardwood flooring

Length	Point	Finish	Coating	Collation	Box Count	Item Code
1 1/2"	Blunt Diamond	Bright	N/A	Straight Glued Strip	1M	RW17BPE
1 3/4"	Blunt Diamond	Bright	N/A	Straight Glued Strip	1M	RW19BPE
2"	Blunt Diamond	Bright	N/A	Straight Glued Strip	1M	RW21BPE
2"	Blunt Diamond	Stainless 304	N/A	Straight Glued Strip	1M	RW21BGE

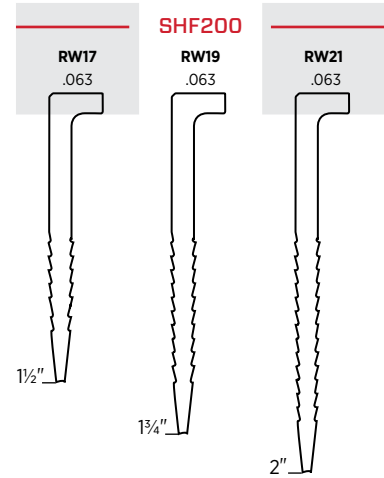

15.5^{GA}

1/2" Crown Flooring Staples

1/2", 5/8", 3/4" Solid hardwood flooring

Length	Point	Finish	Coating	Collation	Box Count	Item Code
1 1/2"	Chisel	Galv	Sencote	Straight Glued Strip	5.2M	FL17BAB
1 3/4"	Chisel	Galv	Sencote	Straight Glued Strip	5.2M	FL19BAB
2"	Chisel	Galv	Sencote	Straight Glued Strip	5.2M	FL21BAB

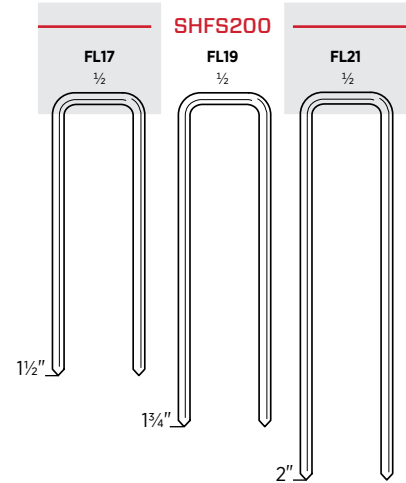

19^{GA}

3/16" Crown Flooring Staples

1/4", 5/16", 3/8" Engineered and hardwood floors

Length	Point	Finish	Coating	Collation	Box Count	Item Code
5/8"	Chisel	Galv	Sencote	Straight Glued Strip	5M	R10BAB
3/4"	Chisel	Galv	Sencote	Straight Glued Strip	5M	R11BAB
1"	Chisel	Galv	Sencote	Straight Glued Strip	5M	R13BAB

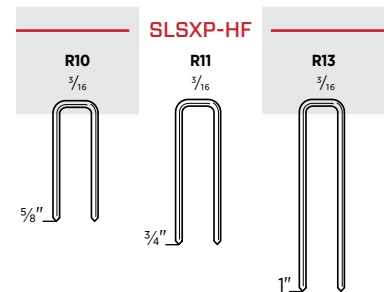

BOX, CARTON & PALLET CONVERSION FASTENERS

Nails

Boxes Per Carton	Cartons Per Pallet	Boxes Per Pallet	Item Code	Boxes Per Carton	Cartons Per Pallet	Boxes Per Pallet	Item Code	Boxes Per Carton	Cartons Per Pallet	Boxes Per Pallet	Item Code
5	180	900	A100509	5	40	200	DA17AIA	N/A	N/A	40	GD21AABF
5	180	900	A100629	5	40	200	DA17EABN	N/A	N/A	48	GD21AABSN
5	180	900	A100759	5	40	200	DA17EPBN	N/A	N/A	40	GD21APBF
5	180	900	A101009	4	40	160	DA19AIA	N/A	N/A	48	GD21APBSN
5	180	900	A101259	4	40	160	DA19EABN	N/A	N/A	45	GD23AHAS
5	180	900	A101379	4	40	160	DA19EPBN	24	32	768	GD24AGES
5	180	900	A101509	4	40	160	DA21EABN	N/A	N/A	40	GD24APBF
5	180	900	A102009	N/A	N/A	90	DA21EGBN	N/A	N/A	45	GD24ASBS
5	180	900	A109809	4	40	160	DA21EPBN	N/A	N/A	40	GD25AABF
5	180	900	A109909	3	72	216	DA23EPB	N/A	N/A	48	GD25AABSN
5	140	700	A201009	3	40	120	DA23EPBN	N/A	N/A	40	GD25APBF
5	140	700	A201257	N/A	N/A	80	DA25EGB	N/A	N/A	72	GE21APAX
5	140	700	A201259	3	40	120	DA25EPB	N/A	N/A	72	GE24AGBX
5	140	700	A201509	3	40	120	DA25EAB	N/A	N/A	72	GE24APBX
5	140	700	A202009	N/A	N/A	24	ED19ASBC	N/A	N/A	72	GE24ASBX
5	140	700	A209809	N/A	N/A	60	ED21AABH	N/A	N/A	40	GL21APBF
5	140	700	A209909	N/A	N/A	60	ED21ADBH	N/A	N/A	45	GL21ASBS
5	96	480	A301500	N/A	N/A	60	ED23AABH	N/A	N/A	40	GL24AABF
5	96	480	A301750	N/A	N/A	24	ED23ASBC	N/A	N/A	48	GL24AABSN
5	96	480	A302000	N/A	N/A	60	ED23ADBH	N/A	N/A	24	GL24AGBF
5	96	480	A302009	N/A	N/A	40	EJ21ADBH	N/A	N/A	72	GL24AGBS
5	96	480	A302500	N/A	N/A	24	EJ21ASBC	N/A	N/A	40	GL24APBF
5	96	480	A302509	N/A	N/A	40	EJ23AABF	N/A	N/A	120	GL24ASBSR
5	96	480	A401009	N/A	N/A	40	EJ23ADBC	N/A	N/A	48	H527APBXN
5	96	480	A401259	N/A	N/A	40	EJ23ADBH	N/A	N/A	80	H527APBXR
5	96	480	A401509	N/A	N/A	24	EJ23ASBC	N/A	N/A	48	H527ASBXN
5	96	480	A401759	N/A	N/A	36	EL15AGEH	N/A	N/A	48	H528APBXN
5	96	480	A402009	N/A	N/A	42	EL17ADBH	N/A	N/A	48	H627APBXN
5	96	480	A402509	N/A	N/A	36	EL17AGEH	N/A	N/A	48	H627ASBXN
5	96	480	A409809	N/A	N/A	126	EL19AGEH	N/A	N/A	80	H627ASBXR
24	30	720	AX10EAA	N/A	N/A	24	EL19ASBC	N/A	N/A	48	HC27APBX
20	30	600	AX11EAA	N/A	N/A	60	EL19ASBH	N/A	N/A	48	HC27ASBX
16	30	480	AX13EAA	N/A	N/A	60	EL20AABH	N/A	N/A	48	HC28APBX
5	140	700	AX13EGAR	6	40	240	EL20AGEB	N/A	N/A	40	HD27APBF
12	30	360	AX15EAA	N/A	N/A	60	EL20ASBH	N/A	N/A	48	HD27APBSN
5	140	700	AX15EGAR	N/A	N/A	42	EL21ADBH	N/A	N/A	40	HD28APBF
10	30	300	AX17EAA	N/A	N/A	60	EL21AGBH	N/A	N/A	48	HE27ASBX
5	140	700	AX17EGAR	N/A	N/A	60	EL21ASBH	N/A	N/A	80	HF27AGBK
10	30	300	AX18EAA	N/A	N/A	60	EL23AABH	N/A	N/A	80	HF27EPAX
8	30	240	AX19EAA	N/A	N/A	60	EL23AGBH	N/A	N/A	80	HF27EDB
5	140	700	AX21EGAR	6	40	240	EL23AGEB	N/A	N/A	45	HJ25ADBS
6	30	180	AX21EAAAN	N/A	N/A	36	EL23AGEC	N/A	N/A	35	HK27APBFN
6	30	180	AX22EAAAN	N/A	N/A	24	EL23ASBC	8	32	256	HL25AUES
24	30	720	AY10EAA	N/A	N/A	60	EL23ASBH	N/A	N/A	40	HL27AABF
20	30	600	AY11EAA	6	40	240	EL25AGEH	N/A	N/A	48	HL27AABSN
16	30	480	AY13EAA	N/A	N/A	36	EL25ASEC	N/A	N/A	24	HL27AGBF
32	30	960	AZ08EAA	6	40	240	EL25AUH	N/A	N/A	54	HL27AGBS
24	30	720	AZ11EAA	8	32	256	FF17AMEB	N/A	N/A	24	HL27ASBF
16	30	480	AZ13EAA	24	32	768	FF17AMEC	N/A	N/A	40	HL27ASBS
N/A	N/A	30	BD17APBC	8	32	256	FF19AMEB	8	32	256	HL27AUES
N/A	N/A	45	BE23AABF	24	32	768	FF19AMEC	N/A	N/A	40	HR22APAF
N/A	N/A	40	BG17AAA	8	32	256	FF20AMEB	N/A	N/A	40	HR74APAF
N/A	N/A	40	BG17AAAQ	24	32	768	FF20AMEC	N/A	N/A	72	K525APBXN
N/A	N/A	40	BG18AAA	6	24	144	FL20AMEB	N/A	N/A	48	K527APBXN
N/A	N/A	40	BG18AAAQ	N/A	N/A	36	FL20AMEC	N/A	N/A	80	K527APBXR
N/A	N/A	35	BK21BPFN	N/A	N/A	80	G521APBXN	N/A	N/A	48	K527ASBXN
N/A	N/A	45	BK21EPBF	N/A	N/A	80	G521ASBXN	N/A	N/A	48	K528APBXN
N/A	N/A	35	BK23BPFN	N/A	N/A	72	G524APBXN	N/A	N/A	80	K528APBXR
N/A	N/A	45	BK23EPBF	N/A	N/A	72	G524ASBXN	N/A	N/A	48	K528ASBXN
N/A	N/A	35	BK25BPFN	N/A	N/A	80	G621APBXN	N/A	N/A	48	K529APBXN
N/A	N/A	45	BL21APBF	N/A	N/A	80	G621ASBXN	N/A	N/A	48	K529ASBXN
N/A	N/A	45	BL23APBF	N/A	N/A	72	G624APBXN	N/A	N/A	48	K627ASBXN
N/A	N/A	45	BT21PBF	N/A	N/A	72	G624ASBXN	N/A	N/A	48	K628APBXN
N/A	N/A	140	CZ08EAAAN	N/A	N/A	80	GC21APBX	N/A	N/A	48	K628ASBXN
N/A	N/A	140	CZ10EAAAN	N/A	N/A	80	GC23AHAK	N/A	N/A	48	K629ASBXN
N/A	N/A	140	CZ11EAAAN	N/A	N/A	72	GC23APBX	N/A	N/A	80	KC27AGBK
5	40	200	DA13EPBN	N/A	N/A	72	GC24APBX	N/A	N/A	48	KC27APBX
5	40	200	DA15AIA	N/A	N/A	72	GC24ASBX	N/A	N/A	64	KC28AGBK
5	40	200	DA15EABN	N/A	N/A	72	GC25AABX	N/A	N/A	48	KC28APBX
5	40	200	DA15EPBN	N/A	N/A	72	GC25APBX	N/A	N/A	48	KC28ASBX

*N/A indicates not packed in cartons – available in boxes or skids only

BOX, CARTON & PALLET CONVERSION FASTENERS

Nails — continued

Boxes Per Carton	Cartons Per Pallet	Boxes Per Pallet	Item Code
N/A	N/A	48	KC29APBX
N/A	N/A	48	KC29ASBX
N/A	N/A	40	KC31APBX
N/A	N/A	40	KD25APBF
N/A	N/A	48	KD25APBSN
N/A	N/A	40	KD27AABF
N/A	N/A	45	KD27AABS
N/A	N/A	48	KD27AABSN
N/A	N/A	40	KD27APBF
N/A	N/A	48	KD27APBSN
N/A	N/A	90	KD27APBSR
N/A	N/A	24	KD27ASBF
N/A	N/A	40	KD27ASBS
N/A	N/A	90	KD27ASBSR
N/A	N/A	40	KD28AABF
N/A	N/A	54	KD28AGBS
N/A	N/A	40	KD28APBF
N/A	N/A	48	KD28APBSN
N/A	N/A	90	KD28APBSR
N/A	N/A	24	KD28ASBF
N/A	N/A	40	KD28ASBS
N/A	N/A	90	KD28ASBSR
N/A	N/A	48	KD29AABSN
N/A	N/A	40	KD29APBF
N/A	N/A	48	KD29APBSN
N/A	N/A	40	KD29ASBS
N/A	N/A	100	KJ17AEBD
N/A	N/A	100	KJ17AHBD
N/A	N/A	100	KJ25AEBD
N/A	N/A	100	KJ25AHBD
8	32	256	KL27AUES
N/A	N/A	36	KL28AUES
20.0	48	960	M001000
16.0	48	768	M001001
16.0	48	768	M001002
12.0	48	576	M001003
5	96	480	M001003GR
12	48	576	M001004
12	48	576	M001005
5	96	480	M001005GR
12	48	576	M001007
5	96	480	M001007GR
N/A	N/A	45	M002038
N/A	N/A	45	M002041
N/A	N/A	45	M002042
N/A	N/A	40	M002101
N/A	N/A	40	M002105
N/A	N/A	100	M002261
N/A	N/A	100	M002262
N/A	N/A	100	M002263
N/A	N/A	100	M002264
N/A	N/A	100	M002265
N/A	N/A	100	M002266
N/A	N/A	100	M002267
N/A	N/A	100	M002268
N/A	N/A	24	M003011
N/A	N/A	24	M003012
N/A	N/A	56	M003101
N/A	N/A	56	M003102
N/A	N/A	56	M003103
N/A	N/A	48	M003104
N/A	N/A	40	M003105
N/A	N/A	40	M003106
N/A	N/A	100	MD17AEBD
N/A	N/A	60	MD17AHAD
N/A	N/A	48	MD23APBSN
N/A	N/A	100	MD25AEBD
N/A	N/A	100	MD25AHBD
N/A	N/A	36	MD27APBSN
N/A	N/A	36	MD28APBSN

Boxes Per Carton	Cartons Per Pallet	Boxes Per Pallet	Item Code
N/A	N/A	40	MD34APBF
N/A	N/A	100	ND25AEBD
N/A	N/A	100	ND25AHBD
12	60	720	RH15EAA
12	60	720	RH17EAA
12	60	720	RH19EAA
12	60	720	RH21EAA
N/A	N/A	45	RH25EAA
10	51	510	RW17BPE
10	51	510	RW19BPE
10	51	510	RW21BGE
10	51	510	RW21BPE
2	51	102	RW21BPEP
N/A	N/A	40	SC19APB
N/A	N/A	40	SC21APB
N/A	N/A	45	SE12ADB
N/A	N/A	40	SE12BDB
N/A	N/A	40	SE15APB
N/A	N/A	40	SE15APBH
N/A	N/A	40	SE17APB
N/A	N/A	40	SE17APBH
N/A	N/A	40	SE19APB
N/A	N/A	40	SE19APBH
12	60	720	ZX10EAA
5	140	700	ZX10EAA NR
12	48	576	ZX13EAA
5	140	700	ZX13EAA NR
12	36	432	ZX16EAA
5	140	700	ZX16EAA NR
12	36	432	ZX18EAA
5	140	700	ZX18EAA NR
10	24	240	ZX21EAA
5	140	700	ZX21EAA NR
5	50	250	W3050YXS
5	50	250	W3075PXC
5	50	250	W3075YXC
5	50	250	W3100YXC
5	50	250	W3125YXC

Staples

Boxes Per Carton	Cartons Per Pallet	Boxes Per Pallet	Item Code
48	24	1152	A04BAAN
6	36	216	A06BABN
8	24	192	A06BABP
12	24	288	A08BAB
8	24	192	A08BABP
8	24	192	B04BAAPN
4	24	96	B05BAAP
20	24	480	B05DAA
4	24	96	B06BAAP
4	24	96	B08BAAP
8	24	192	C02BAAPN
8	24	192	C03BGAN
8	24	192	C04BAAP
8	34	272	C04BGAN
8	24	192	C05BAAPN
4	24	96	C06BAAP
20	32	640	C06BGA
20	32	640	C06BHA
4	24	96	C07BAAPN
4	24	96	C08BAAP
4	24	96	C10BAAP
6	36	216	D10BABN
8	24	192	D10BABPN
20	32	640	E06BAA
16	32	512	E08BAA
25	32	800	E10BAA

Boxes Per Carton	Cartons Per Pallet	Boxes Per Pallet	Item Code
12	32	384	F04BAAN
8	24	192	F04BAAP
4	24	96	F05BAAP
10	30	300	F06BAA
4	24	96	F06BAAP
10	24	240	F06BGA
8	30	240	F08BAAN
4	24	96	F08BAAP
8	24	192	F08BGA
10	3	30	F08FAB
8	30	240	F08GAB
N/A	N/A	48	FL17BAB
N/A	N/A	40	FL19BAB
N/A	N/A	40	FL21BAB
24	20	480	G04BAAN
25	32	800	G06BABN
20	32	640	G08BAB
20	20	400	G10BAB
20	24	480	H06BAA
15	16	240	J06BAA
9	32	288	J08BAAN
8	20	160	J10BAAN
8	36	288	K08BABN
9	32	288	K10BABN
6	40	240	K11BAB
10	40	400	K12BAB
12	32	384	K13BABN
10	36	360	L06BAB
N/A	N/A	112	L07BAP
N/A	N/A	112	L07BQBP
8	36	288	L08BAB
16	36	576	L08BABN
12	36	432	L10BABN
12	36	432	L10BHA
12	36	432	L10HABN
10	36	360	L11BAB
10	36	360	L11BGA
10	36	360	L11BRB
10	36	360	L11HAB
12	36	432	L11HBB
10	36	360	L12BAB
10	36	360	L12BQB
8	36	288	L13BABN
8	36	288	L13BRBN
8	36	288	L13HABN
6	36	216	L14BAB
6	36	216	L14BGA
6	36	216	L14BRB
6	36	216	L15BAB
6	36	216	L15BRB
6	36	216	L17BAB
N/A	N/A	192	M004092
7	32	224	M060BABN
6	32	192	M08BAB
9	32	288	M10BABN
9	32	288	M10BRBN
8	32	256	M11BABN
8	32	256	M11BRBN
6	32	192	M12BAB
6	32	192	M13BAB
6	32	192	M13BRB
N/A	N/A	60	M15BAB
N/A	N/A	48	M17BAB
6	32	192	N08BABN
6	32	192	N08BBBN
6	32	192	N08FBB
6	32	192	N11BAB
6	32	192	N11BRB
6	32	192	N11FBB
6	32	192	N12BABN

*N/A indicates not packed in cartons — available in boxes or skids only

BOX, CARTON & PALLET CONVERSION FASTENERS

Staples — continued

Boxes Per Carton	Cartons Per Pallet	Boxes Per Pallet	Item Code
5	32	160	N12FABN
4	32	128	N13BAB
4	32	128	N13BRB
4	32	128	N13FAB
N/A	N/A	56	N14BAB
N/A	N/A	56	N14BRB
N/A	N/A	56	N14FAB
N/A	N/A	56	N15BAB
N/A	N/A	56	N15BGB
N/A	N/A	56	N15BRB
N/A	N/A	56	N15FAB
N/A	N/A	56	N16BAB
N/A	N/A	56	N16BRB
N/A	N/A	56	N16RRB
N/A	N/A	48	N17BAB
N/A	N/A	165	N17BGB
N/A	N/A	48	N17BPE
N/A	N/A	48	N17BRB
N/A	N/A	48	N18BAB
N/A	N/A	48	N18BRB
N/A	N/A	40	N19BAB
N/A	N/A	130	N19BGBN
N/A	N/A	40	N19BPE
N/A	N/A	40	N19BRB
N/A	N/A	40	N21BAB
N/A	N/A	120	N21BGBN
N/A	N/A	40	N21BPE
N/A	N/A	40	N21BRB
N/A	N/A	56	O15BRBB
N/A	N/A	56	O16BRBB
N/A	N/A	48	O17BRBB
N/A	N/A	48	O18BRBB
N/A	N/A	48	O19BRBB
N/A	N/A	60	P06BAA
N/A	N/A	60	P08BABT
N/A	N/A	60	P10BAB
N/A	N/A	60	P10BPE
N/A	N/A	60	P10FAB
N/A	N/A	50	P11BAB
N/A	N/A	50	P11BPE
N/A	N/A	40	P12BAB
N/A	N/A	40	P13BAB
N/A	N/A	60	P13BGBN
N/A	N/A	40	P13BPE
N/A	N/A	30	P15BAB
N/A	N/A	30	P15BPE
N/A	N/A	30	P17BAB
N/A	N/A	40	P19BAB
N/A	N/A	40	P21BAB
N/A	N/A	64	Q15BAB
N/A	N/A	64	Q17BAB
N/A	N/A	64	Q17BRB
N/A	N/A	64	Q19BAB
N/A	N/A	130	Q19BGBN
N/A	N/A	64	Q19BRB
N/A	N/A	56	Q21BAB
N/A	N/A	56	Q21BRB
N/A	N/A	48	Q23BAB
N/A	N/A	48	Q23BRB
N/A	N/A	48	Q25BAB
N/A	N/A	100	Q25BGBN
N/A	N/A	48	Q25BRB
12	32	384	R08BAB
12	40	480	R10BAB
12	40	480	R11BAB
12	40	480	R13BAB
10	40	400	W10BAB
12	32	384	W11BABN
N/A	N/A	72	X04NRA
N/A	N/A	72	X06NRA

Boxes Per Carton	Cartons Per Pallet	Boxes Per Pallet	Item Code
na	na	72	X08NRA
8	32	256	Y05BFA
8	32	256	Y07BFA
8	32	256	Y09BFA

Screws

Tubs Per Carton	Cartons Per Pallet	Tubs Per Pallet	Item Code
6	24	144	O6A125P
N/A	N/A	72	O6A125PB*
6	24	144	O6A162P
N/A	N/A	72	O6A162PB*
6	24	144	O6A162W
6	24	144	O6B125P
N/A	N/A	72	O6B125PB*
6	24	144	O6B162P
6	24	144	O6C100C
6	24	144	O6C125C
N/A	N/A	72	O6C125CB*
N/A	N/A	72	O6C125PB*
6	24	144	O6C125WK*
6	24	144	O6C162C
N/A	N/A	72	O6C162CB*
N/A	N/A	72	O6C162PB*
6	24	144	O6C162WK*
6	24	144	O6C200C
N/A	N/A	72	O6C200PB*
6	24	144	O7A200P
6	24	144	O7M044PTDPS
N/A	N/A	72	O7Q100PB*
6	24	144	O7Q125QS
6	24	144	O7Q125PB*
N/A	N/A	72	O7Q125PBQ*
6	24	144	O8A250PK*
N/A	N/A	72	O8C125PB
6	24	144	O8C300WK*
6	24	144	O8D175W
6	24	144	O8D200W
6	24	144	O8D250S
6	24	144	O8D250W
6	24	144	O8D300W
6	24	144	O8F150W
6	24	144	O8F150Y
6	24	144	O8F175Y
6	24	144	O8F200Y
N/A	N/A	72	O8F200YBTHSS*
6	24	144	O8F250Y
6	24	144	O8F300Y
6	40	240	O8G100CKNFDP*
6	24	144	O8G150CTLDSS
6	24	144	O8G162CTWFWS*
6	32	192	O8G200CKLFPS*
6	24	144	O8G200CTWFWS
6	24	144	O8G200WTWFWS
6	24	144	O8G250CTWFWS
6	24	144	O8G300CTWFWS
N/A	N/A	72	O8L125CBLCTS*
N/A	N/A	72	O8L175YB*
6	24	144	O8M050CTRFDP
6	24	144	O8M050CTRFSP
6	24	144	O8R250S
6	24	144	O8R250S596
6	24	144	O8R250W
6	24	144	O8R300W
6	24	144	O8S250W003
6	24	144	O8S250W497
6	24	144	O8S250W592
6	24	144	O8S250W596

Tubs Per Carton	Cartons Per Pallet	Tubs Per Pallet	Item Code
6	24	144	O8S300W003
6	24	144	O8S300W497
6	24	144	O8S300W592
6	24	144	O8S300W596
6	24	144	O8T125W
N/A	N/A	72	O8T150WBWTDs*
6	24	144	O8T200W
N/A	N/A	72	O8X125CBACTS*
6	40	240	O8X125CKADDS*
6	32	192	O8X200CKADDS*
6	24	144	O9D300S
6	24	144	10F200Y
1	72	72	10G125CBWFDS*
6	24	144	10G162CTWFWS
6	24	144	10M050CTRFDP
N/A	N/A	72	10M062CBFFDX*
6	40	240	10M075CKNFDP*
6	24	144	10M075CTMFDS
6	40	240	10M075YKFT4X*
N/A	N/A	48	10M075YLF4X
6	24	144	10M075YTFDX
6	24	144	10M100CKMFDS*
6	40	240	12G175YKLFAX*
6	32	192	12G200YKLFAX*
6	32	192	12G250YKLFAX*
6	40	240	12M087YKFF4X*
6	40	240	12M100YKFF3X*
6	24	144	12M150CTFFDX

*Packaged in boxes, not tubs

Hidden Deck Fasteners

Boxes Per Carton	Cartons Per Pallet	Boxes Per Pallet	Item Code
8	32	256	HDL38590
8	32	256	HDL39690
8	32	256	HDLTRX90
N/A	N/A	36	HDL385450
N/A	N/A	36	HDL396450
N/A	N/A	36	HDLTRX450
24	32	768	HDSC38525
24	32	768	HDSC39625
24	32	768	HDSCTRX25
24	32	768	HDFC25
8	32	256	HDC38590
8	32	256	HDC39690
8	32	256	HDCTRX90
N/A	N/A	36	HDC385450
N/A	N/A	36	HDC396450
N/A	N/A	36	HDCTRX450

*N/A indicates not packed in cartons — available in boxes or skids only

THE INNOVATION YOU'VE COME TO EXPECT, NOW WITH 200 PSI

Whether you need an air compressor for punch-out jobs or for all-day performance, SENCO offers high quality, reliable options to meet your needs.

FEATURES

Our new line of 200 psi air compressors provides plenty of tank storage and air flow for the job site or professional shop. They're equipped with dual couplers so you can run two hoses simultaneously. They feature an oil-free pump design to reduce maintenance, and integrated control panels provide easy access to couplers, control knobs and highly visible gauges. The newly designed full roll cage protects vital components.

These 200 psi options complement SENCO's iconic PC1010N portable finish and trim air compressor. Powerful, but also ultra-quiet and lightweight, the PC1010N features an oil-free pump design, integrated control panel and rugged roll cage.

A full line of hoses and accessories is available for all compressors.



PC0968N

1¼ HP (RUNNING) 4½ GALLON
TWIN STACK AIR COMPRESSOR



Features

- 200 max psi
- Heavy-duty induction motor with low 95-volt start
- Rugged roll cage to protect critical components
- Integrated control panel for ease of use

PC0969

1¼ HP (RUNNING) 4½ GALLON
ROLL AWAY AIR COMPRESSOR



Features

- 200 max psi
- Heavy-duty induction motor with low 95-volt start
- Rugged roll cage to protect critical components
- Integrated control panel for ease of use

PC0970

1¼ HP (RUNNING) 15 GALLON
VERTICAL ELECTRIC AIR COMPRESSOR



Features

- 200 max psi
- Heavy-duty induction motor with low 95-volt start
- Rugged roll cage to protect critical components
- Integrated control panel for ease of use

200 PSI COMPRESSORS

- More stored energy runs air tools longer
- Fast recovery time increases productivity
- Maintains operating pressure longer
- Improves efficiency on the job

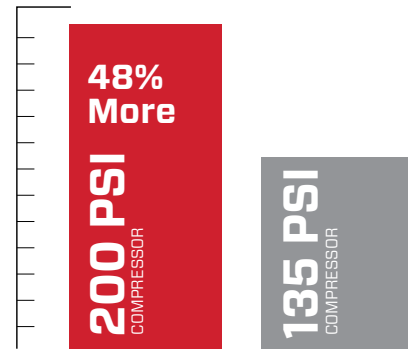

Usable Air Per Gallon

Air Compressor Reference Chart

SPECS	PC0968N	PC0969	PC0970
Motor	Induction	Induction	Induction
Amps	14	14	14
Power Source	120 Volts	120 Volts	120 Volts
SCFM @ 90 PSI	4.9	4.9	4.9
Max PSI	200	200	200
Weight	65 lbs (30 kg)	87 lbs (40 kg)	99 lbs (45 kg)
Height	17.75" (451 mm)	27" (686 mm)	40" (1016 mm)
Length	17.25" (438 mm)	18" (457 mm)	18.75" (476 mm)
Width	21" (533 mm)	17" (432 mm)	19.25" (489 mm)
Warranty	1 yr	1 yr	1 yr
FEATURES			
Thermal Overload Protector	Yes	Yes	Yes
Pump	Oil-Free	Oil-Free	Oil-Free
Pump Up/Recovery Time	105 sec./30 sec.	105 sec./30 sec.	345 sec./85 sec.
¼" Quick Connect Coupler	2 (Dual)	2 (Dual)	2 (Dual)
Regulator	Yes	Yes	Yes
Individual Tank and Outlet Gauges	Yes	Yes	Yes
Cold Start Valve	Yes	Yes	Yes
CSA Approved	Yes	Yes	Yes

PC1130

1 HP (RUNNING) 2½ GALLON
FINISH AND TRIM AIR COMPRESSOR



Features

- Cast-iron cylinder for superior pump life
- Lightweight — 39 lbs
- Heavy-duty induction motor

PC0968

1 HP (RUNNING) 2½ GALLON TWIN TANK
FINISH AND TRIM AIR COMPRESSOR



Features

- Compact twin stack tank design
- Lightweight — 38 lbs
- Heavy-duty induction motor

PC1131

2 HP (RUNNING) 4.3 GALLON
TWIN TANK AIR COMPRESSOR



Features

- Cast-iron cylinder for superior pump life
- Compact twin stack tank design
- Heavy-duty induction motor

PC1280

1½ HP (RUNNING) 6 GALLON
FINISH AND TRIM AIR COMPRESSOR



Features

- Compact and balanced pancake tank design
- Lightweight — 38 lbs
- Dual quick connect couplers

Air Compressor Reference Chart

SPECS	PC1130	PC1131	PC0968	PC1280
Motor	Induction	Induction	Induction	Universal
Amps	13	14	8	12
Power Source	115 Volts	115 Volts	115 Volts	115 Volts
SCFM @ 90 PSI	3.5	4.4	2.2	2.8
Max PSI	125	125	135	150
Weight	39 lbs (17.7 kg)	60 lbs (27 kg)	38 lbs (17.24 kg)	38 lbs (17.24 kg)
Height	18.5" (470 mm)	14.5" (368 mm)	13.5" (343 mm)	18" (457 mm)
Length	20.5" (521 mm)	20.5" (521 mm)	16" (406 mm)	17" (432 mm)
Width	8" (203 mm)	16.5" (419 mm)	15" (381 mm)	16.3" (414 mm)
Warranty	1 yr	1 yr	1 yr	1 yr
FEATURES				
Thermal Overload Protector	Yes	Yes	Yes	Yes
Pump	Oil-Lube	Oil-Lube	Oil-Free	Oil-Free
Pump Up/Recovery Time	39 sec./10 sec.	67 sec./16 sec.	82 sec./17 sec.	152 sec./33 sec.
¼" Quick Connect Coupler	1	1	1	2 (Dual)
Regulator	Yes	Yes	Yes	Yes
Individual Tank and Outlet Gauges	Yes	Yes	Yes	Yes
Cold Start Valve	Yes	Yes	No	No
CSA Approved	Yes	Yes	Yes	Yes

PC1010

½ HP (RUNNING) 1 GALLON
FINISH AND TRIM AIR COMPRESSOR



Features

- Ultra-quiet — 68 dBA
- Ultra-light — 20 lbs
- Heavy-duty induction motor

PC1010N

½ HP (RUNNING) 1 GALLON
FINISH AND TRIM AIR COMPRESSOR



Features

- Ultra-quiet — 68 dBA
- Ultra-light — 21 lbs
- Heavy-duty induction motor

PC0947

2" FINISHPRO®18 BRAD NAILER
AND PC1010 COMPRESSOR KIT



18^{GA}

Features

- 1 gallon PC1010 compressor
- 2" 18 gauge brad nailer
- Everything you need to get started

PC0974

1" MICRO PINNER
AND PC1010 COMPRESSOR KIT



23^{GA}

Features

- 1 gallon PC1010 compressor
- 1" 23 gauge micro pinner
- Everything you need to get started

Air Compressor Reference Chart

SPECS	PC1010	PC1010N
Motor	Induction	Induction
Amps	4	4
Power Source	115 Volts	115 Volts
SCFM @ 90 PSI	0.7	0.7
Max PSI	135	135
Weight	20 lbs (9.07 kg)	21 lbs (9.53 kg)
Height	13" (330 mm)	12.25" (311 mm)
Length	14" (356 mm)	11.5" (292 mm)
Width	10" (254 mm)	14" (356 mm)
Warranty	1 yr	1 yr
FEATURES		
Thermal Overload Protector	Yes	Yes
Pump	Oil-Free	Oil-Free
Pump Up/Recovery Time	125 sec./30sec	125 sec./30sec.
¼" Quick Connect Coupler	1	1
Regulator	Yes	Yes
Individual Tank and Outlet Gauges	Yes	Yes
Cold Start Valve	No	No
CSA Approved	Yes	Yes

Tool Kit Reference Chart

KIT SPECS	PC0947	PC0974
Compressor	PC1010	PC1010
Tool	FinishPro® 18	FinishPro® 10
Trigger	Contact	Sequential
Tool Operating Pressure	70-95 psi	70-95 psi
Tool Air Inlet	¼" NPT	¼" NPT
Tool Weight	3 lbs (1.6 kg)	2.4 lbs (1.1 kg)
Tool Height	9.3" (238 mm)	6.75" (171 mm)
Tool Length	9.75" (248 mm)	8.9" (225 mm)
Kit Warranty	1 yr	1 yr
Coil Hose	¼" x 25'	¼" x 25'
Air Fittings	Yes	Yes
Tool Oil and Safety Glasses	Yes	Yes
Variety Pack of Fasteners	18 Ga. Brads	23 Ga. Micro Pins
FASTENER SPECS		
Gauge	18 Ga. Brads	23 Ga. Micro Pins
Range	5/8"-2"	½"-1"

ACCESSORIES

FILTERS, REGULATORS, LUBRICANTS, PLUGS, COUPLERS, HOSES, PART KITS AND MORE

SENCO offers an assortment of accessories that are precision engineered to meet the demanding requirements of professionals. Be sure that your tools and compressors are running at peak performance by using SENC certified replacement parts, accessories, hoses, oils and lubricants.



Air Hoses

SENCO offers a wide variety of air hoses in various materials, sizes and specifications for your job site.

Quick Couple Rubber Hose

SENCO's premium air hoses:

- Can handle up to 250 psi working pressure
- 4-to-1 working pressure to burst safety factor
- Oil-resistant nitrile tube
- Tough, flexible neoprene cover
- Braided textile reinforcing for max strength and kink resistance
- Remains flexible at temperatures from -40° to 200°F



GRAY WITHOUT FITTINGS
PC0045, PC0046,
PC0048, PC0049



GRAY WITH MPT ENDS
PC0059, PC0060,
PC0062, PC0063



GRAY WITH PLUG
& COUPLER
PC0064, PC1152,
PC0065



BULK GRAY HOSE
PC0041, PC0042

Description	Hose Size	Length	Qty.	ITEM #
Gray without Fittings (Use with LHB-Type Fittings)	¼"	50 ft	1	PC0045
Gray without Fittings (Use with LHB-Type Fittings)	¼"	100 ft	1	PC0046
Gray without Fittings (Use with LHB-Type Fittings)	⅜"	50 ft	1	PC0048
Gray without Fittings (Use with LHB-Type Fittings)	⅜"	100 ft	1	PC0049
Gray without Fittings (Use with LHB-Type Fittings)	¼"	50 ft	1	PC0059
Gray with MPT Ends (Use with FPT-Type Fittings)	¼"	100 ft	1	PC0060
Gray with MPT Ends (Use with FPT-Type Fittings)	⅜"	50 ft	1	PC0062
Gray with MPT Ends (Use with FPT-Type Fittings)	⅜"	100 ft	1	PC0063
Gray with Industrial Interchange Plug and Coupler Fittings	¼"	50 ft	1	PC0064
Gray with Industrial Interchange Plug and Coupler Fittings	¼"	100 ft	1	PC1152
Gray with Industrial Interchange Plug and Coupler Fittings	⅜"	50 ft	1	PC0065
Bulk Gray without Fittings (Use with LHB-Type Fittings)	¼"	450 ft & up	1	PC0041
Bulk Gray without Fittings (Use with LHB-Type Fittings)	⅜"	450 ft & up	1	PC0042

Bulk hose can only be purchased in reels of 450 feet and up with a maximum of four sections. Priced by the foot. Not packaged for retail.

ProFlex™ Reinforced Polyurethane Red Air Hose

Lightest available non-marring flexible hose

- Flexible in all weather (-48° to 150°F)
- Durable — oil and fuel resistant
- Working pressure: 250 psi
- MPT-threaded ends



PROFLEX WITH MPT ENDS
PC0977, PC0978,
PC0979, PC0980

Description	Hose Size	Length	Qty.	ITEM #
ProFlex™ with MPT Ends (Use with FPT-Type Fittings)	¼"	50 ft	1	PC0977
ProFlex™ with MPT Ends (Use with FPT-Type Fittings)	¼"	100 ft	1	PC0978
ProFlex™ with MPT Ends (Use with FPT-Type Fittings)	⅜"	50 ft	1	PC0979
ProFlex™ with MPT Ends (Use with FPT-Type Fittings)	⅜"	100 ft	1	PC0980

PVC Air Hose

- Made with specially formulated polyvinyl chloride
- Resistant to lubricating oils, chemicals and ultraviolet sunlight
- Flexible in temperatures from -20° to 150°F
- Handles up to 300 psi working pressure
- MPT-threaded ends



PVC WITH MPT ENDS
PC0075, PC0078

Description	Hose Size	Length	Qty.	ITEM #
PVC with MPT Ends (Use with FPT-Type Fittings)	¼"	50 ft	1	PC0075
PVC with MPT Ends (Use with FPT-Type Fittings)	⅜"	50 ft	1	PC0078

Premium Hybrid Polymer Air Hose

- Provides the ultimate in flexibility and memory resistance, even in extreme cold
- Offers the best combination of strength and flexibility on the market



HYBRID WITH MPT ENDS
PC1319, PC1320

Description	Hose Size	Length	Qty.	ITEM #
Hybrid with MPT Ends (Use with FPT-Type Fittings)	¼"	50 ft	1	PC1319
Hybrid with MPT Ends (Use with FPT-Type Fittings)	¼"	100 ft	1	PC1320
Hybrid Field-Repairable with MPT Ends (Use with FPT-Type Fittings)	¼"	50 ft	1	PC1321
Hybrid Field-Repairable with MPT Ends (Use with FPT-Type Fittings)	¼"	100 ft	1	PC1322

(LHB) - Locking Hose Barb, no clamp required when used with Senco Quick Couple Hose.
(SHB) - Standard Hose Barb, requires hose clamps. See page 77 for hose clamps.
(FPT) - Female Pipe Thread
(MPT) - Male Pipe Thread

Plugs & Couplers

Quick connect plugs and couplers are available in the most popular Industrial Interchange styles. Couplers are also available in Universal style.

Universal Couplers — push plug into coupler (no need to pull back on sleeve)

Type	Body Size	NPT Size	Pack Qty.	ITEM #
Female	¼"	¼" FPT	1	PC0900
Female	¼"	¼" FPT	10	PC0698
Male	¼"	¼" MPT	1	PC0901
Male	¼"	¼" MPT	10	PC0699



FEMALE COUPLER
PC0900, PC0698



MALE COUPLER
PC0901, PC0699

Plug and coupler hose assembly sets — Industrial Interchange

Description	Body Size	NPT Size	Pack Qty.	ITEM #
Connects to Hose with MPT Fittings	¼"	¼" FPT	1	PC0563
Connects to Hose without MPT Fittings	¼"	¼" LHB	1	PC0565



PLUG AND COUPLER
PC0563

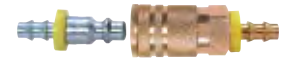

PLUG AND COUPLER
PC0565

Plugs — Industrial Interchange

Type	Body Size	Size	Pack Qty.	ITEM #
Male	¼"	¼" MPT	2	PC0479
Male	¼"	¼" MPT	10	PC0231
Male	¼"	⅜" MPT	2	PC0480
Male	¼"	⅜" MPT	10	PC0413
Male	⅜"	⅜" MPT	10	PC0232
Female	¼"	¼" FPT	2	PC0477
Female	¼"	¼" FPT	10	PC0239
Female	¼"	⅜" FPT	2	PC0478
Female	¼"	⅜" FPT	10	PC0410
Push-on Barb	¼"	¼" LHB	1	PC0576
Push-on Barb	¼"	¼" LHB	10	PC0235
Push-on Barb	¼"	⅜" LHB	1	PC0577
Push-on Barb	¼"	⅜" LHB	10	PC0412
Push-on Barb	¼"	¼" SHB	10	PC0243



MALE PLUG
PC0479, PC0231, PC0480,
PC0413, PC0232



FEMALE PLUG
PC0477, PC0239,
PC0478, PC0410



PLUG (PUSH-ON LOCKING BARB)
PC0576, PC0235, PC0577, PC0412



PLUG (PUSH-ON STANDARD BARB)
PC0243

Couplers — Industrial Interchange

Type	Body Size	Size	Pack Qty.	ITEM #
Male	¼"	¼" MPT	1	PC0503
Male	¼"	¼" MPT	10	PC0201
Male	¼"	⅜" MPT	1	PC0504
Male	¼"	⅜" MPT	10	PC0380
Female	¼"	¼" FPT	1	PC0501
Female	¼"	¼" FPT	10	PC0209
Female	¼"	⅜" FPT	1	PC0502
Female	¼"	⅜" FPT	10	PC0378
Female	⅜"	⅜" FPT	10	PC0210
Push-on Barb	¼"	¼" LHB	1	PC0505
Push-on Barb	¼"	¼" LHB	10	PC0205
Push-on Barb	¼"	⅜" LHB	1	PC0506
Push-on Barb	¼"	⅜" LHB	10	PC0379
Push-on Barb	¼"	¼" SHB	10	PC0213



MALE COUPLER
PC0503, PC0201, PC0504, PC0380,



FEMALE COUPLER
PC0501, PC0209,
PC0502, PC0378, PC0210



COUPLER (PUSH-ON LOCKING BARB)
PC0505, PC0205, PC0506, PC0379



COUPLER (PUSH-ON STANDARD BARB)
PC0213

(LHB) - Locking Hose Barb, no clamp required when used with SENCO Quick Couple Hose.

(SHB) - Standard Hose Barb, requires hose clamps. See page 77 for hose clamps.

(FPT) - Female Pipe Thread

(MPT) - Male Pipe Thread

Swivel Plugs & Couplers

- Allow easier access when working in corners and tight spaces
- Reduce fatigue
- Help prevent kinks and reduce stress on hose
- Provide strong and simple connection for pneumatic tools

Swivel Plugs — Industrial Interchange				
Type	Body Size	NPT Size	Pack Qty.	ITEM #
Male	¼"	¼" MPT	2	PC1323
Male	¼"	¼" MPT	10	PC1324
Male	¼"	¾" MPT	2	PC1325



MALE SWIVEL PLUG
PC1323, PC1324, PC1325

Swivel Couplers — Industrial Interchange				
Type	Body Size	NPT Size	Pack Qty.	ITEM #
Male	¼"	¼" MPT	1	PC1326
Male	¼"	¼" MPT	10	PC1327
Female	¼"	¼" FPT	1	PC1328
Female	¼"	¼" FPT	10	PC1329



MALE SWIVEL COUPLER
PC1326, PC1327



FEMALE SWIVEL COUPLER
PC1328, PC1329

Swivel Couplers — Universal				
Type	Body Size	NPT Size	Pack Qty.	ITEM #
Female	¼"	¼" FPT	1	PC1330
Female	¼"	¼" FPT	10	PC1331



FEMALE SWIVEL COUPLER
PC1330, PC1331

Air Hose Accessories

Splicer				
Description	Size	Pack Qty.	ITEM #	
Push-On Barbed Hose Splicer	¼" LHB	2	PC0643	
Push-On Barbed Hose Splicer	¾" LHB	2	PC0644	



PUSH-ON BARBED HOSE SPLICER
PC0643, PC0644

ProFlex Hose Fittings				
Description	Size	Pack Qty.	ITEM #	
Brass Hose End	¼" MPT	1	PC0983	
Brass Hose End	¾" MPT	1	PC0984	
Brass Hose End and Splicer	¼" MPT	1	PC0987	
Brass Hose End and Splicer	¾" MPT	1	PC0988	



BRASS HOSE END
PC0983, PC0984



BRASS HOSE END & SPLICER
PC0987, PC0988

Hose Clamps				
Description	Size	Pack Qty.	ITEM #	
Hose Clamp	¼"	1	PC0352	
Hose Clamp	¾"	1	PC0353	
Hose Clamp	⅝"	1	PC0354	
Crimping Pliers	N/A	1	PC0443	



HOSE CLAMP
PC0352



HOSE CLAMP
PC0353



HOSE CLAMP
PC0354



CRIMPING PLIERS
PC0443

(LHB) - Locking Hose Barb, no clamp required when used with SENCO Quick Couple Hose.
 (SHB) - Standard Hose Barb, requires hose clamps.
 (FPT) - Female Pipe Thread
 (MPT) - Male Pipe Thread

Air Hose and Compressor Accessories

Tripod Manifold				
Description	Inlet Thread	Outlet Thread	Pack Qty.	ITEM #
3-Way Round Manifold	3/8" FPT	1/4" FPT	1	PC0444
3-Way Flat Manifold Industrial Interchange	1/4" Plug	1/4" Coupler	1	PC1138



3-WAY ROUND MANIFOLD
PC0444



3-WAY FLAT MANIFOLD
PC1138

Blow Gun			
Description	Inlet Thread	Pack Qty.	ITEM #
Air Blow Gun	1/4" FPT	1	PC0489



AIR BLOW GUN
PC0489

Teflon® Thread Sealing Tape		
Description	Pack Qty.	ITEM #
1/2" x 260' Sealing Tape	1	PC0349



SEALING TAPE
PC0349

Drain Plug

Drain Cock			
Description	Size	Qty.	ITEM #
Drains Moisture from Tank, Finger Adjustable	1/4" MPT	1	PC0357



DRAIN PLUG
PC0357

Filters, Regulators & Gauges

SENCO's assortment of filters, regulators and gauges are precision engineered to meet the demanding requirements of professional contractors. Be sure that your compressor is running at peak performance by using SENCO-certified replacement parts and accessories.

Air Regulation Accessories: Regulator with Gauge					
Description	Max PSI	Max Airflow	FPT Size	NPT Gauge	ITEM #
Mini Regulator with Gauge	250	14 SCFM	1/4"	1/8"	PC0656
Regulator with Gauge	300	14 SCFM	1/4"	1/8"	PC0653
Regulator with Gauge	300	80 SCFM	3/8"	1/8"	PC0657
Filter/Regulator with Gauge	150	14 SCFM	1/4"	1/8"	PC0660
Filter	150	14 SCFM	1/4"	—	PC0655
In-Line Regulator (Regulate Multiple Tools from One Compressor)	150	—	1/4"	1/4"	PC0436
Back-Mount Pressure Gauge	160	—	—	1/8"	PC0057
Back-Mount Pressure Gauge	160	—	—	1/4"	PC0051

(LHB) - Locking Hose Barb, no clamp required when used with SENCO Quick Couple Hose.
(SHB) - Standard Hose Barb, requires hose clamps. See page 77 for hose clamps.
(FPT) - Female Pipe Thread
(MPT) - Male Pipe Thread



MINI REGULATOR
WITH GAUGE
PC0656



REGULATOR
WITH GAUGE
PC0653



REGULATOR
WITH GAUGE
PC0657



FILTER/REGULATOR
WITH GAUGE
PC0660



FILTER
PC0655



IN-LINE REGULATOR
PC0436



BACK-MOUNT
PRESSURE GAUGE
PC0057



BACK-MOUNT
PRESSURE GAUGE
PC0051

Oils & Lubricants

Oils and Lubricants				
Description	Features	Size	Case Qty.	ITEM #
Pneumatic Tool Oil (½ pt)	<ul style="list-style-type: none"> Premium-grade oil with high-quality paraffin distillate stock Contains a carefully balanced rust and oxidation inhibitor with an effective anti-foaming additive 	8 oz	12	PC0101
Pneumatic Tool Oil (1 qt)	<ul style="list-style-type: none"> Premium-grade oil with high-quality paraffin distillate stock Contains a carefully balanced rust and oxidation inhibitor with an effective anti-foaming additive 	32 oz	12	PC0102
Pneumatic Tool Oil (1 gal)	<ul style="list-style-type: none"> Premium-grade oil with high-quality paraffin distillate stock Contains a carefully balanced rust and oxidation inhibitor with an effective anti-foaming additive 	128 oz	4	PC0103
Compressor Pump Oil (1 qt)	<ul style="list-style-type: none"> Premium-grade oil with high-quality naphthenic distillate stock Recommended for all oil-splash compressors Protects against corrosion Lubricates to extend part life 	32 oz	12	PC0344
Moisture Shield Tool Lubricant (1 qt)	<ul style="list-style-type: none"> For use in cold weather and/or high-moisture areas Protects against corrosion Lubricates to extend part life Special additive to minimize exhaust fog 	32 oz	12	PC1295
Tool Lubricant	<ul style="list-style-type: none"> Protects against corrosion Lubricates to extend part life Special additive to minimize exhaust fog 	4 oz	12	YB0123



PNEUMATIC TOOL OILS
 ½ pt PC0101 1 qt PC0102 1 gal PC0103



COMPRESSOR PUMP OIL PC0344 MOISTURE SHIELD TOOL LUBRICANT PC1295 TOOL LUBRICANT YB0123

Safety Glasses & Tool Belt Hooks

SENCO's safety glasses offer the ultimate in style and comfort while providing the highest level of eye protection, produced with a strong, lightweight polycarbonate lens that meets or exceeds ANSI Z87.1 and CE EN 166 safety standards.

Safety Glasses		
Description	Qty.	ITEM #
Wrap-Around Safety Glasses*	10-Case	PC1166
Standard Clear Safety Glasses	10-Case	PC1284

*Filters 99% of UVA and UVB rays. For indoor and outdoor use.



WRAP AROUND PC1166 STANDARD PC1284



Tool Belt Hooks			
Description	Size	Qty.	ITEM #
Attaches to ¼" Air Fitting on Tool	Standard	1	PC0350
Attaches to ¼" Air Fitting on Tool	X-Wide	1	PC0629
Attaches to ⅜" Air Fitting on Tool	Standard	1	PC0351
Attaches to ⅜" Air Fitting on Tool	X-Wide	1	PC0630
Attaches to Belt and Fits FinishPro®42XP	Standard	1	PC0934



BELT HOOK PC0350 BELT HOOK PC0629
 BELT HOOK PC0351 BELT HOOK PC0630 BELT HOOK PC0934

Battery Systems

Compatible with all 18V Li-Ion Duraspin II and SENCO FUSION tools

18V Li-Ion Battery 1.5 Amp Hour	Fits	
VB0155	DS212-18V DS215-18V DS312-18V DS215-XP All Fusion Models	 <ul style="list-style-type: none"> • 1.5 amp hour • High-quality reliable cells • Long storage life • Charges 80% in 15 minutes
18V Li-Ion Battery 3.0 Amp Hour	Fits	
VB0161	DS212-18V DS215-18V DS312-18V DS215-XP All Fusion Models	 <ul style="list-style-type: none"> • 3.0 amp hour • High-quality reliable cells • Long storage life • Drives up to 2X as many fasteners as VB0155

Charger System

Can be used interchangeably with SENCO VB0155, VB0161 and VB0118 batteries

Battery Charger	For use with	
VB0156	VB0155 VB0161 VB0118	 <ul style="list-style-type: none"> • Battery charge indicators display charge status of your battery • Compatible with all SENCO 18V Li-Ion batteries

No-Mar Pads

No-Mar pads replacement, one per pack.



No-Mar Pads Fit	ITEM #
AF25, CF25	HF0064
AF41, CF41	HF0079
FIP11	HC0463
FIP15, FIP18	HC0506
FIP15Mg, FIP18Mg	HC0571
FIP23SXP, 23LXP, 21LXP	HC0729
FIP25XP	HF0064
FIP32*	HC0396
FIP32*	HC0401
FIP41XP, FIP42XP	HF0079
FN55AX	HF0113
FN65DA	HF0110
FP600-650 SERIES	HF0046, HC0253
FP601, FP602, FP651, FP652	HA0170
FP700 SERIES	HF0046, HC0253

No-Mar Pads Fit	ITEM #
GT65DA	HC0626
GT65RHA	HC0625
GT90CH	HA0200
GT90FRH	HA0201
SCN49	HC0536
SFN30, SFN40, SFNI	HF0079
SLS15, SLS18	HC0507
SLS15Mg, SLS18Mg	HC0572
SLS20, SLS20XP (K, L & R CROWNS)	HF0028
SLS20, SLS20XP (M CROWN)	HF0029
SLS25-L, SLS25XP-L	HF0028

*Refer to parts chart to identify desired safety element design.

Maintaining Your Tools

SENCO repair kits are designed to provide the parts normally needed to properly maintain and service your SENCO tools.





Tool Model	Description	Item Code
FinishPro15, 18, 2N1	Repair Kit	YK0393
FinishPro15Mg, 18Mg	Repair Kit	YK0780
FinishPro18BMg	Repair Kit	YK0868
FinishPro23LXP, 21LXP	Repair Kit	YK0855
FinishPro23SXP	Repair Kit	YK0854
FinishPro25XP	Firing System Kit	YK0281
FinishPro25XP	Piston Stop Kit	YK0282
FinishPro32	Repair Kit	YK0394
FinishPro33Mg	Repair Kit	YK0787
FinishPro35Mg	Repair Kit	YK0788
FinishPro41XP, 42XP	Firing System Kit	YK0361
FinishPro41XP, 42XP	Piston Stop Kit	YK0362
FramePro601, 602, 651, 652	Repair Kit	YK0360
FramePro XP 701, 752, 702, 752	Firing System Kit	YK0243
FramePro XP 701, 752, 702, 752	Piston Stop Kit	YK0244
HN150, HN250	Repair Kit	BA0158
JoistPro150XP	Firing System Kit	YK0823
JoistPro150XP	Piston Stop Kit	YK0824
JoistPro250XP	Firing System Kit	YK0825
JoistPro250XP	Piston Stop Kit	YK0826
JoistPro250XP	Safety Upgrade Kit	YK0869
LS1XP	Repair Kit	YK0858
MW	Repair Kit	YK0371
PAL57FXP	Repair Kit	YK0446
RoofPro™ 455XP	Firing System Kit	YK0424
RoofPro™ 445XP	Repair Kit	YK0865
RoofPro™ 455XP	Piston Stop Kit	YK0425
RoofPro™ 450XP	Repair Kit	YK0426
SC 1	Repair Kit	YK0370
SC 2	Repair Kit	YK0371
SCN48	Repair Kit	YK0769
SCN49	Repair Kit	YK0771
SCN60, SCN65	Repair Kit	YK0366
SFN1, SKS, SPS	Repair Kit	YK0376
SFN1, SKS, SPS	Retrofit Kit	YK0368
SFN30	Repair Kit	YK0368
SFN40	Repair Kit	YK0367
SFT10XP, SFT10XP D/L, SFT10XP LN	Piston Stop Kit	YK0802

Tool Model	Description	Item Code
SFT10XP, SFT10XP D/L, SFT10XP LN	Firing System Kit	YK0803
SFT10XP (AUTO)	Firing System Kit	YK0804
SFT10XP (AUTO D/L)	Firing System Kit	YK0804
SFT10XP (AUTO D/L)	Piston Stop Kit	YK0802
SFN1, SKS, SPS	Firing System Kit	YK0804
SFW09	Repair Kit	YK0775
SFW10XP	Piston Stop Kit	YK0321
SFW10XP	Firing System Kit	YK0322
SHD150XP	Firing System Repair Kit	YK0823
SHD150XP	Piston Bumper Repair Kit	YK0824
SLP20	Repair Kit	YK0373
SLS15, SLS18	Repair Kit	YK0393
SL15MG, SLS18MG	Repair Kit	YK0780
SLS20	Repair Kit	YK0372
SLS25XP	Piston Stop Kit	YK0291
SLS25XP	Firing System Kit	YK0359
SCP40XP	Firing System Kit	YK0444
SCP40XP	Piston Stop Kit	YK0445
SN901XP, SN902XP, FramePro325XP	Firing System Kit	YK0444
SN901XP, SN902XP, FramePro325XP	Piston Stop Kit	YK0445
SN951XP, SN952XP	Firing System Kit	YK0444
SN951XP, SN952XP	Piston Stop Kit	YK0768
SNS40	Repair Kit	YK0374
SNS41	Repair Kit	YK0423
SNS41 (Retrofit Kit)	Cap/Firing Valve	YJ0034
SNS44XP	Firing System Kit	YK0421
SNS44XP	Piston Stop Kit	YK0422
SNS45XP	Firing System Kit	YK0230
SNS45XP	Piston Stop Kit	YK0231
SNS50XP, SQS55XP	Repair Kit	YK0375
SNS200XP-BST	Firing System Kit	YK0838
SNS200XP-BST	Piston Stop Kit	YK0839
SNS200XP	Firing System Kit	YK0840
SNS200XP	Piston Stop Kit	YK0841
SNS200XP	Block-Out Kit	YK0850
SNS200XP	Siding Safety Kit	HC0748
WC150RXP, WC150XP, WC200XP	Repair Kit	YK0783
WC150RXP, WC150XP, WC200XP	Block-Out Kit	YK0786
WC150RXP, WC150XP, WC200XP	Retrofit Kit-Solid Safety	YJ0037

FINISH & WOODWORKING

15 GA - 34°	16 GA	16 GA - 20°	18 GA	21 GA	23 GA
					
Pg. 34	Pg. 33	Pg. 33	Pg. 32-33	Pg. 32	Pg. 32
19 GA	18 GA	16 GA	SENCOR	SENCLAMP	
					
Pg. 35	Pg. 35-36	Pg. 36	Pg. 37	Pg. 37	

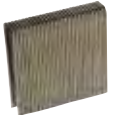
FRAMING, SHEATHING & SUBFLOORS

34°	34° Prohead	20°	COIL	METAL	CONCRETE	15 GA	16 GA	17 GA
								
Pg. 45	Pg. 46	Pg. 47-48	Pg. 48-50	Pg. 51	Pg. 51	Pg. 53	Pg. 52-53	Pg. 52

ROOFING, SIDING & FENCING

ROOFING	16 GA WIDE CROWN	BUTTON CAP	20 GA	WIRE WELD	PLASTIC WOUND
					
Pg. 57	Pg. 59	Pg. 59	Pg. 59	Pg. 57-58	Pg. 57-58

FLOORING

CLEAT	15.5 GA	19 GA
		
Pg. 74	Pg. 74	Pg. 74





PALLETS & CRATING

15° SMOOTH	15° RING	15° SCREW	20 GA	18 GA
				
Pg. 63-64	Pg. 63-64	Pg. 65	Pg. 65	Pg. 65



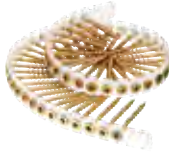
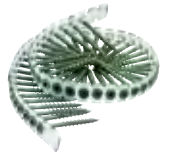

UPHOLSTERY & FURNITURE

22 GA	21 GA	20 GA	17 GA	16 GA
				
Pg. 69	Pg. 69	Pg. 70	Pg. 71	Pg. 71

AUTO-FEED SCREW SYSTEMS

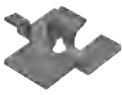
DRYWALL	WOOD TO WOOD	WOOD TO STEEL	UNDERLAYMENT	DECKS/DOCKS	METAL TO METAL
					
Pg. 8	Pg. 8	Pg. 9	Pg. 8	Pg. 9-10	Pg. 10-13



HIDDEN DECK CLIP SYSTEMS

DECK CLIP	STARTER CLIP	FINISH CLIP	SCREWS	COLLATED
				
Pg. 17-19	Pg. 17-19	Pg. 17-19	Pg. 17-19	Pg. 17-19



FUSION

15 GA - 20°	16 GA	16 GA - 20°	18 GA
			
Pg. 23	Pg. 22	Pg. 23	Pg. 22





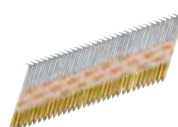
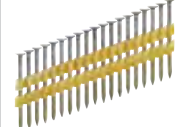





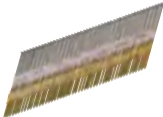

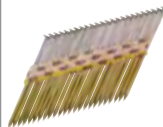
CORROSION RESISTANT FASTENERS ALUMINUM

0° COIL	15° COIL
	
Pg. 57	Pg. 58

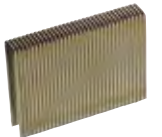
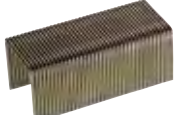

HOT DIPPED GALVANIZED

34°	20°	15° COIL
		
Pg. 45, 46, & 51	Pg. 47-48	Pg. 49, 57, 58, 63 & 64

304 STAINLESS STEEL

15 GA	16 GA	18 GA	34°	20°	0° COIL	15° COIL	15 GA
							
Pg. 23 & 34	Pg. 22 & 33	Pg. 22 & 32	Pg. 45	Pg. 47-48	Pg. 57	Pg. 49, 57, 58 & 63	Pg. 53
16 GA	18 GA	20 GA	22 GA	#2 FLAT HEAD	#2 TRIM HEAD	CLEAT	
							
Pg. 36, 52, 53, 59 & 71	Pg. 35	Pg. 65 & 70	Pg. 69	Pg. 9	Pg. 10	Pg. 74	

316 STAINLESS STEEL

20°	15°
	
Pg. 48	Pg. 58

**SENCO
FASTENERS
AT A GLANCE**

FINISH & WOODWORKING

FinishPro23SXP 8F0001N	FinishPro23LXP 8L0001N	FinishPro21LXP 8M0001N	LS1XP 8N0001N	FinishPro18Mg 1U0021N	FinishPro18BMg 9B0001N	SLP20XP 430101N
						
Pg. 25	Pg. 25	Pg. 26	Pg. 26	Pg. 26	Pg. 26	Pg. 27
FinishPro25XP 760102N	FinishPro32 1X0201N	FinishPro33Mg 6F0001N	SFN30 620002N	FinishPro35Mg 6G0001N	FinishPro42XP 4G0001N	SLS20XP SEE SPECIFICATIONS
						
Pg. 27	Pg. 28	Pg. 28	Pg. 28	Pg. 29	Pg. 29	Pg. 30
SLS25XP SEE SPECIFICATIONS	SKSXP SEE SPECIFICATIONS	SLS150Mg 8C0001N	SLS18Mg 1W0021N	SC1XP 220101N	SC2 470001N	
						
Pg. 30	Pg. 30	Pg. 31	Pg. 31	Pg. 31	Pg. 31	

Fasteners: see pages 32-37

FRAMING, SHEATHING & SUBFLOORS

FramePro325XP 4Z0101N	FramePro701XP 2H0133N	FramePro325FRHXP 4H0101N	FramePro702XP 2K0103N	FramePro752XP 2F0103N		
						
Pg. 39	Pg. 39	Pg. 40	Pg. 40	Pg. 40		
SCN49XP 5J0001N	SCN60XP 520101N	SCN65XP 540101N	JoistPro150XP 7L0001N	JoistPro250XP 6K0001N	Mini Hand Nailer PC1195	A20 Hand Nailer PC0781
						
Pg. 41 & 55	Pg. 41	Pg. 41	Pg. 42	Pg. 42	Pg. 42	Pg. 42
SCP40XP 7J0001N	WC150XP 4W0001N	WC200XP 4Y0001N	SNS41 3L0003N	SNS200XP 7B0001N	SQS55XP 660101N	
						
Pg. 43	Pg. 43	Pg. 43	Pg. 44	Pg. 44	Pg. 44	

Fasteners: see pages 45-53

ROOFING, SIDING & FENCING

RoofPro455XP	RoofPro445XP	SCN49XP	WC150RXP	BC58 Button Cap	A11 Stapling Hammer
3D0101N	8V0001N	5J0001N	4X0001N	4A0001N	PC0700
					
Pg. 55	Pg. 55	Pg. 41 & 55	Pg. 56	Pg. 56	Pg. 56

Fasteners: see pages 57-59







FLOORING

SHF200	SHFS200	SLS20XP-HF
8D0001N	8D0002N	490021N
		
Pg. 73	Pg. 73	Pg. 73

Fasteners: see page 74



PALLETS & CRATING

PalletPro57FXP	PalletPro100XP	PalletPro130XP	DFXP	F75LXP	F75SXP
4L0001N	5L0001N	5M0001N	8H0001N	8J0002N	8J0001N
					
Pg. 61	Pg. 61	Pg. 61	Pg. 62	Pg. 62	Pg. 62

Fasteners: see pages 63-65

UPHOLSTERY & FURNITURE

SFT10XP, Long Nose, and Double Length Magazine	SFW09	SNS200XP-BST
SEE SPECIFICATIONS	4C0001N	7C0001N
		
Pg. 67	Pg. 68	Pg. 68

Fasteners: see pages 69-71



COMPRESSORS

PC0968N	PC0969	PC0970	PC1130	PC1131	PC0968	PC1280	PC1010	PC1010N
								
Pg. 79	Pg. 79	Pg. 79	Pg. 80	Pg. 80	Pg. 80	Pg. 80	Pg. 81	Pg. 81

SCREW SYSTEMS

DS215-18V 7W0001N	DS212-18V 7X0001N	DS312-18V 7Y0001N	DS215-XP 7W0002N	DS235-AC 7T0001N	DS232-AC 7U0001N	DS332-AC 7V0001N
						
Pg. 3	Pg. 3	Pg. 3	Pg. 3	Pg. 4	Pg. 4	Pg. 4
DS425AC 6W0012N		DS440AC 6W0011N		DS220 6W0001N		
						
Pg. 5		Pg. 5		Pg. 6		
DS320 6W0003N				SG4100 6X0004N	SG2510 6X0002N	
						
Pg. 6				Pg. 7	Pg. 7 & 17	

Fasteners: see pages 8 - 13

FUSION

F-18 6E0001N	F-16S 6U0001N	F-16A 5P0001N	F-15 5N0001N
			
Pg. 21	Pg. 21	Pg. 21	Pg. 21

Fasteners: see pages 22-23

HIDDEN DECK

SHD150XP 9D0001N

Pg. 17

LI-ION BATTERIES & CHARGERS

18V LI-ION VB0155	18V 3AH VB0161
	
Pg. 15, 21 & 88	Pg. 15, 21 & 88
18V LI-ION CHARGER VB0156	
	
Pg. 15, 21 & 88	

FUSION
TECHNOLOGY



DURASPIN
TECHNOLOGY

FASTENER FINISH TYPES

CORROSION RESISTANT TYPES

HOT DIPPED GALVANIZED

Hot Dipped Galvanized nails have one ounce per square foot of zinc coating. The zinc coating on the nail acts as a barrier between the base steel and the elements, slowing the corrosion process. Ideal for preservative-treated wood and most exterior applications.



GOOD
CORROSION
RESISTANCE

304 STAINLESS STEEL

For moderate environments. 304 Stainless Steel contains 18% chromium and 8% nickel among other elements, making it resist most oxidizing acids and rust. An excellent choice for all types of environments and woods including exotic woods, cedar or redwood. Recommended use: Exposure to wet conditions regularly and more than 5 miles away from a body of water.



BETTER
CORROSION
RESISTANCE

316 STAINLESS STEEL

For extreme environments. 316 Stainless Steel contains 16% chromium, 10% nickel, and 2% molybdenum. The addition of molybdenum and a higher nickel content increases the corrosion resistance properties of 316 Stainless Steel. The ultimate choice for highly corrosive environments and works well in all types of woods. Recommended use: Exposure to extreme corrosive elements (salt, air and moisture) and within 5 miles of the coast.



BEST
CORROSION
RESISTANCE

ALUMINUM NAILS

Ideal for use in soft woods, particularly cedar and redwood applications to eliminate staining, bleeding, or streaking. Often used for attaching siding and fencing. Aluminum nails are also recommended when installing aluminum siding. Aluminum nails ARE NOT recommended for use in preservative-treated wood or hardwoods.

BRIGHT BASIC

Bright Basic fasteners are an uncoated steel, which is commonly used in application where corrosion protection is not required such as, interior framing, finish and trim. These fasteners are not recommended for the use in treated lumber or exterior applications.

ELECTRO GALVANIZED

Electro-Galvanized fasteners have a thin layer of zinc coating that helps corrosion resistance in mild weather conditions and in areas with lower humidity. Because of its minimal protective properties these fasteners are recommended for interior use in areas such as kitchens and bathrooms.