



DISSTON®

A Cut Above Since 1840

BLU-MOL®

RemGrit®



Aggressor®



WWW.DISSTONTOOLS.COM



OUR HAND MADE HISTORY

From the beginning, Henry Disston knew that to compete with the then superior English tools, he would need to make the best saw the world had ever known. That was 1840. With superior manufacturing, a vision for innovation, and an earnestness of spirit, Disston created saws manufactured to usher in a new industrial age. Today, Disston is a global manufacturer of hole saws, bandsaw blades, jig saw blades, reciprocating saw blades, drill bits, and other hand and power tool related accessories for the DIY, contractor and industrial markets. Its domestic operation is located in Chicopee, MA. The company also operates fabrication and production enterprises overseas. Disston's international manufacturing and distribution capabilities combined with its history and tradition as a brand leader in the tool category for over 165 years provide its customers the optimum blend of value, performance and integrity.



DRILLS & POWER WOOD BORING BITS..... 4

- Blu-Mol® Black Oxide Jobber Drills 7
- Blu-Mol® Titanium Jobber Drills 9
- Blu-Mol® Xtreme Cobalt Jobber Drills 11
- Blu-Mol® Glass & Tile Drills 12
- Blu-Mol Xtreme® Masonry Drills 12
- Blu-Mol Xtreme® Quad-Tipped Glass & Tile Drills 12
- Blu-Mol Xtreme® Spade Bits 13
- Blu-Mol® Extensions 13
- Blu-Mol® Screw Extractors 14
- Blu-Mol Xtreme® Power Wood Boring Bits 14
- Blu-Mol® Countersinks 15
- Blu-Mol® Drill/Countersinks 15

HOLE SAWS..... 16

- Blu-Mol Xtreme® Bi-Metal Hole Saws 20
- Blu-Mol® Bi-Metal Hole Saws 22
- Blu-Mol® Sheet Metal Hole Saws 24
- Blu-Mol Xtreme® Tri-Cut Hole Cutters..... 25
- Blu-Mol® Standard Cut Hole Cutters..... 26
- Blu-Mol Xtreme® Carbide Tipped Hole Saws 27
- Blu-Mol® Carbon Steel Hole Saws..... 28
- RemGrit® Carbide Grit Light Installation Kits 28
- RemGrit® Carbide Grit Hole Saws..... 29
- Blu-Mol® & RemGrit® Hole Saw Accessories 30
- Blu-Mol® & Blu-Mol Xtreme® Lock Installation Kits 31

RECIPROCATING SAW BLADES..... 32

- Blu-Mol Xtreme® Bi-Metal Demo & Rescue Blades..... 33
- Blu-Mol® Bi-Metal Reciprocating Blades 34
- Blu-Mol Xtreme® Pallet Blades..... 35
- RemGrit® Carbide Grit Reciprocating Blades..... 35

JIG SAW BLADES..... 36

- Blu-Mol® Bi-Metal Jig Saw Blades 37
- Blu-Mol® Carbon Jig Saw Blades 37
- Blu-Mol® High Speed Steel Jig Saw Blades..... 37
- Blu-Mol® Jig Saw Blade Sets 38
- RemGrit® Carbide Grit Jig Saw Blades 38
- RemGrit® Multi-Product Assortments 38

AIR SAW & HACKSAW BLADES..... 39

- Blu-Mol® Air Saw Blades..... 39
- Blu-Mol® Bi-Metal Hacksaw Blades 39
- RemGrit® Carbide Grit Hacksaw Blades..... 40

ROD SAW, CIRCULAR SAW & PORTABLE BANDSAW BLADES

- RemGrit® Carbide Grit Rod Saw Blades 40
- RemGrit® Carbide Grit Circular Saw Blades 41
- Aggressor® Portable Bandsaw Blades 41

BANDSAW BLADES 42

- Aggressor® Bi-Metal & Matrix II Narrow Width 48
- Aggressor® Bi-Metal Bandsaw Blades..... 48
- RemGrit® Carbide Grit Bandsaw Blades 50
- Aggressor® Carbon Bandsaw Blades..... 51

FASTENERS..... 52

- Blu-Mol® Bits..... 54
- Blu-Mol® Sets 55
- Blu-Mol® Adaptors 55
- Blu-Mol® Guides 55

WARRANTY INFORMATION..... 56

DRILL BIT INDEX

Disston offers a variety of drilling and wood boring bits designed to meet your many DIY and professional drilling needs. Bits and accessories are available in convenient packages, sets and bulk.

GENERAL PURPOSE



Blu-Mol® Black Oxide Drill Bits
For general purpose use in metal, wood and plastic.



Blu-Mol® Titanium Drill Bits
For extended life and industrial use capabilities in metal, wood and plastic.



Blu-Mol® Xtreme Cobalt Drill Bits
For use exclusively in metal applications.

GLASS & TILE



Blu-Mol® Glass & Tile Drill Bits
For cutting holes in glass and tile.



Blu-Mol® Xtreme Quad-Tipped Glass & Tile
For accurate cutting into mirrors, ceramic, glass & tile.

MASONRY



Blu-Mol® Xtreme Masonry Drill Bits
For drilling into masonry, concrete, rock and stone.

POWER WOOD BORING



Blu-Mol® Xtreme Spade Bits
For drilling precise flat bottom holes in wood.



Blu-Mol® Screw Extractors
For removing screws and bolts with broken or damaged heads.



Blu-Mol® Xtreme Power Bore Bits
Cutting spurs reduce splintering to ensure smooth clean holes in wood.



Blu-Mol® Countersinks
For countersinking, deburring and chamfering in wood, soft metal, plastic and other machinable materials.



Blu-Mol® Drill/Countersinks
Drills, countersinks and counterbores all in one operation in wood or composition material.



DRILL BIT SIZE REFERENCE CHART

DRILL BITS

DIAMETER		Blu-Mo® Black Oxide Carded / Envelope	Blu-Mo® Black Oxide (12" Ext. Length) Carded	Blu-Mo® Black Oxide S & D Bits Carded	Blu-Mo® Titanium Jobber Length Carded / Envelope	Xtreme® Cobalt Jobber Length Carded	Blu-Mo® Glass & Tile Carded	Xtreme® Glass & Tile Carded	Xtreme® Masonry (3" Length) Carded / 3pk	Xtreme® Masonry (4" Length) Carded / 3pk	Xtreme® Masonry (6" Length) Carded	Xtreme® Masonry (13" Length) Clamshell	Xtreme® Spade (4" Length) Carded	Xtreme® Spade (6" Length) Carded	Xtreme® Spade (16" Length) Carded	Xtreme® Power Wood Carded
Inches	MM															
1/16	1,58	6625	--	--	3251	3283	--	--	--	--	--	--	--	--	--	--
5/64	1,98	6626	--	--	3252	3284	--	--	--	--	--	--	--	--	--	--
3/32	2,38	6627	--	--	3253	3285	--	--	--	--	--	--	--	--	--	--
7/64	2,77	6628	--	--	3254	3286	--	--	--	--	--	--	--	--	--	--
1/8	3,18	6629	6674	--	3255	3287	3430	--	3407	--	--	--	--	--	--	--
9/64	3,57	6630	--	--	3256	3288	--	--	--	--	--	--	--	--	--	--
5/32	3,97	6631	--	--	3257	3289	--	--	3408 / 3409	--	--	--	--	--	--	--
11/64	4,37	6632	--	--	3258	3290	--	--	--	--	--	--	--	--	--	--
3/16	4,76	6633	6675	--	3259	3291	3431	4430	--	3410 / 3411	--	--	--	--	--	--
13/64	5,16	6634	--	--	3260	3292	--	--	--	--	--	--	--	--	--	--
7/32	5,56	6635	--	--	3261	3293	--	--	--	--	--	--	--	--	--	--
15/64	5,95	6636	--	--	3262	3294	--	--	--	--	--	--	--	--	--	--
1/4	6,35	6637	6676	--	3263	3295	3432	4431	--	3412 / 3413	3417	3423	--	3380	--	--
17/64	6,75	6638	--	--	3264	3296	--	--	--	--	--	--	--	--	--	--
9/32	7,14	6639	--	--	3265	3297	--	--	--	--	--	--	--	--	--	--
19/64	7,54	6640	--	--	3266	3298	--	--	--	--	--	--	--	--	--	--
5/16	7,94	6641	6677	--	3267	3299	3433	4432	--	3414	3418	3424	--	3381	--	--
21/64	8,33	6642	--	--	3268	3300	--	--	--	--	--	--	--	--	--	--
11/32	8,73	6643	--	--	3269	3301	--	--	--	--	--	--	--	--	--	--
23/64	9,13	6644	--	--	3270	3302	--	--	--	--	--	--	--	--	--	--
3/8	9,53	6645	6678	--	3271	3303	3434	4433	--	3415	3419	3425	3372	3382	3397	--
25/64	9,92	6650	--	--	3272	3304	--	--	--	--	--	--	--	--	--	--
13/32	10,32	6651	--	--	3273	3305	--	--	--	--	--	--	--	--	--	--
27/64	10,72	6652	--	--	3274	3306	--	--	--	--	--	--	--	--	--	--
7/16	11,11	6653	6684	--	3275	3307	--	--	--	--	--	--	--	3383	--	--
29/64	11,51	6654	--	--	3276	3308	--	--	--	--	--	--	--	--	--	--
15/32	11,91	6655	--	--	3277	3309	--	--	--	--	--	--	--	--	--	--
31/64	12,30	6656	--	--	3278	3310	--	--	--	--	--	--	--	--	--	--
1/2	12,70	6657	6685	--	3279	3311	3435	4434	--	3416	3420	3426	3373	3384	3398	3600
9/16	14,29	--	--	6692	--	--	--	--	--	--	--	--	--	3385	--	3601
5/8	15,88	--	--	6693	--	--	--	4435	--	--	3421	3427	3374	3386	3399	3602
11/16	17,46	--	--	--	--	--	--	--	--	--	--	--	--	3387	--	--
3/4	19,05	--	--	6694	--	--	--	4436	--	--	3422	3428	3375	3388	3400	3603
13/16	20,64	--	--	--	--	--	--	--	--	--	--	--	--	3389	--	--
7/8	22,23	--	--	6695	--	--	--	--	--	--	--	--	3376	3390	3401	3604
15/16	23,81	--	--	--	--	--	--	--	--	--	--	--	--	3391	--	--
1	25,40	--	--	6696	--	--	--	4437	--	--	--	--	3377	3392	3402	3605
1-1/8	28,57	--	--	--	--	--	--	--	--	--	--	--	--	3393	--	--
1-1/4	31,75	--	--	--	--	--	--	--	--	--	--	--	3378	3394	--	3606
1-3/8	34,92	--	--	--	--	--	--	--	--	--	--	--	--	3395	--	--
1-1/2	38,10	--	--	--	--	--	--	--	--	--	--	--	3379	3396	--	--

TECH TIPS FOR GENERAL PURPOSE DRILL BITS





- Always wear eye protection.
- Keep the drill chuck tight to prevent drill bit slippage.
- Avoid bit breakage when drilling by not applying sideways pressure on bit.
- Use lightweight oil lubricant for high speed drilling in metal.

RECOMMENDED OPERATING SPEEDS (RPM TABLES) FOR DRILL BITS AND WOOD BORING BITS

These guidelines are provided by Disston Company as information on the generally recommended operating speeds for hole saws and cutters. Disston Company recommends that users always follow the specific recommendations of the hole saw manufacturer concerning hole saw and cutter use and operating speeds.

DIAMETER		MAX RPM (TR/MIN)
INCHES	MM	
Glass & Tile - Blu-Mol® & Blu-Mol Xtreme®		
1/8	3,18	1000
3/16	4,76	750
1/4	6,35	500
5/16	7,94	400
3/8	9,53	350
1/2	12,70	250
5/8	15,88	200
3/4	19,05	160
1	25,40	120
Masonry - Blu-Mol Xtreme®		
Type of Material		
Tile		300
Stone		1000
Brick		2000
Concrete		2000
Countersink - Blu-Mol®		
All Sizes		2500
Power Wood Bits - Blu-Mol Xtreme®		
All Sizes		1000-2000

DRILL BIT SELECTION

Material Applications:	Recommended  Acceptable  Not Recommended 															
	Wood	Plastic / Drywall	Sheet Metal	Mild Steel	Aluminum, Brass & Copper	Cast Iron	Stainless Steel	Glass / Mirror	Marble	Concrete	Fieldstone Granite	Ceramic Tile	Brick / Cement Block Rock & Stone	Slate	Plaster	
Black Oxide	●	●	●	●	◐	○	○	●	●	●	◐	○	○	○	○	
Titanium	●	●	●	●	◐	◐	◐	●	●	●	◐	◐	◐	◐	◐	
Cobalt	○	○	○	●	●	●	●	○	○	●	●	●	●	●	●	
Spade Bits	●	○	○	○	○	○	○	○	○	○	○	○	○	○	○	
Power Bore Bits	●	○	○	○	○	○	○	○	○	○	○	○	○	○	○	
Countersinks	●	○	○	○	○	○	○	○	○	○	○	○	○	○	○	
Drill/Countersinks	●	○	○	○	○	○	○	○	○	○	○	○	○	○	○	
Glass & Tile	○	○	○	○	○	○	○	●	●	○	○	●	○	○	○	
Masonry	○	○	○	○	○	○	○	○	●	●	●	●	●	●	◐	



BLU-MOL® BLACK OXIDE DRILL BITS

Black oxide drill bits provide good performance in soft metal, low alloy steel, plastic and wood.



DRILL BITS



Jobber Drill Bits (Carded)

DIAMETER	MODEL #	MIN. ORDER QTY.	PRODUCT CODE
1/16 2 Per Card	6625	5	E0101038
5/64 2 Per Card	6626	5	E0101039
3/32 2 Per Card	6627	5	E0101040
7/64 2 Per Card	6628	5	E0101041
1/8 2 Per Card	6629	5	E0101042
9/64	6630	5	E0101043
5/32	6631	5	E0101044
11/64	6632	5	E0101045
3/16	6633	5	E0101046
13/64	6634	5	E0101047
7/32	6635	5	E0101048
15/64	6636	5	E0101049
1/4	6637	5	E0101050
17/64	6638	5	E0101051
9/32	6639	5	E0101052
19/64	6640	5	E0101053
5/16	6641	5	E0101054
21/64	6642	5	E0101055
11/32	6643	5	E0101056
23/64	6644	5	E0101057
3/8	6645	5	E0101058
25/64 w/ 3/8 Shank	6650	5	E0101059
13/32 w/ 3/8 Shank	6651	5	E0101060
27/64 w/ 3/8 Shank	6652	5	E0101061
7/16 w/ 3/8 Shank	6653	5	E0101062
29/64 w/ 3/8 Shank	6654	5	E0101063
15/32 w/ 3/8 Shank	6655	5	E0101064
31/64 w/ 3/8 Shank	6656	5	E0101065
1/2 w/ 3/8 Shank	6657	5	E0101066

Jobber Drill Bits (Envelope)

DIAMETER	QTY. PER ENVELOPE	PRODUCT CODE
1/16	12	E0100854
5/64	12	E0100855
3/32	12	E0100856
7/64	12	E0100857
1/8	12	E0100858
9/64	12	E0100859
5/32	12	E0100860
11/64	12	E0100861
3/16	12	E0100862
13/64	12	E0100863
7/32	12	E0100864
15/64	12	E0100865
1/4	12	E0100866
17/64	12	E0100867
9/32	12	E0100868
19/64	6	E0100869
5/16	6	E0100870
21/64	6	E0100871
11/32	6	E0100872
23/64	6	E0100873
3/8	6	E0100874
25/64 w/ 3/8 Shank	6	E0100875
13/32 w/ 3/8 Shank	6	E0100876
27/64 w/ 3/8 Shank	6	E0100877
7/16 w/ 3/8 Shank	6	E0100878
29/64 w/ 3/8 Shank	6	E0100879
15/32 w/ 3/8 Shank	6	E0100880
31/64 w/ 3/8 Shank	6	E0100881
1/2 w/ 3/8 Shank	6	E0100882

Extended Length (Carded)

DIAMETER & LENGTH	MODEL #	MIN. ORDER QTY.	PRODUCT CODE
1/8 x 12	6674	5	E0101718
3/16 x 12	6675	5	E0101069
1/4 x 12	6676	5	E0101070
5/16 x 12	6677	5	E0101071
3/8 x 12	6678	5	E0101072
7/16 x 12 w/ 3/8 Shank	6684	5	E0101073
1/2 x 12 w/ 3/8 Shank	6685	5	E0101074



Silver & Deming (Carded)

DIAMETER	MODEL #	MIN. ORDER QTY.	PRODUCT CODE
9/16 w/ 3/8 Shank	6692	5	E0101075
5/8 w/ 3/8 Shank	6693	5	E0101076
3/4 w/ 3/8 Shank	6694	5	E0101077
7/8 w/ 3/8 Shank	6695	5	E0101078
1 w/ 3/8 Shank	6696	5	E0101079

BLU-MOL® BLACK OXIDE DRILL BITS



Model #6670

Model #6671



Model #3237

Model #3328

Drill Bits – Sets

SET PIECE COUNT	MODEL #	MIN. ORDER	PRODUCT CODE
13PC: 1/16, 5/64, 3/32, 7/64, 1/8, 9/64, 5/32, 11/64, 3/16, 13/64, 7/32, 15/64 and 1/4 in Plastic Drill Buddy with dial top.	6670	5	E0101907
14PC: 1/16 (2), 5/64, 3/32, 7/64, 1/8 (2), 9/64, 5/32, 3/16, 7/32, 1/4, 5/16 and 3/8 in Plastic Case.	6671	10	E0101908
21PC: 1/16, 5/64, 3/32, 7/64, 1/8, 9/64, 5/32, 11/64, 3/16, 13/64, 7/32, 15/64, 1/4, 17/64, 9/32, 19/64, 5/16, 21/64, 11/32, 23/64 and 3/8 plus Metal Index.	3237	5	E0102599
29PC: 1/16, 5/64, 3/32, 7/64, 1/8, 9/64, 5/32, 11/64, 3/16, 13/64, 7/32, 15/64, 1/4, 17/64, 9/32, 19/64, 5/16, 21/64, 11/32, 23/64, 3/8, 25/64*, 13/32*, 27/64*, 7/16*, 29/64*, 15/32*, 31/64* and 1/2* plus Metal Index. *3/8-in Reduced Shank.	3238	5	E0102600



23"-1/4" W (without product)

20-Prong Jobber Drill Pegboard Display

DRILL WALL DISPLAY	PRODUCT CODE
Contains: (2) cards each of the following sizes: 1/16, 5/64, 3/32, 7/64, 1/8, 9/64, 5/32, 11/64, 3/16, 13/64, 7/32, 1/4, 9/32, 5/16, 11/32, 3/8, 7/16 and 1/2, (2) of the 14PC Drill Bit set, Header and 20-Prong Metal Rack (hangs from pegboard).	E0320101
DISPLAY COMPONENTS	PRODUCT CODE
20-Prong Metal Rack hangs from pegboard. (21" H x 23-1/4" W without product).	E4108190
Black Oxide Drill Bit Header (3" H x 23" W).	E2121333



Countertop Bulk Bin

DRILL BIT ASSORTMENT / DISPLAY	PRODUCT CODE
Contains: (29) drills in envelopes. (12) drills per envelope: 1/16, 5/64, 3/32, 7/64, 1/8, 9/64, 5/32, 11/64, 3/16, 13/64, 7/32, 15/64, 1/4, 17/64 and 9/32; (6) drills per envelope: 19/64, 5/16, 21/64, 11/32, 23/64, 3/8, 25/64, 13/32, 27/64, 7/16, 29/64, 15/32, 31/64 and 1/2 and Bulk Metal Bin with slots referenced by size, drill gauge, header and keys.	E0320221
DISPLAY ONLY	PRODUCT CODE
Bulk Metal Bin for Drill Bits (Accommodates 29 drills, 1/16 through 1/2. Slots referenced by size. Drill gauge, header and 2 keys. Non-skid pads. Stickers on sides of bin detail how to select drill bits. (9-1/4" H x 14-3/4" W x 8" D)	E0100362



BLU-MOL® TITANIUM DRILL BITS



Titanium M2 steel drill bits provide best performance needed in industrial and multi-purpose applications in soft metal, brass, bronze, low alloy steel, sheet metal and moderate jobs in hard metal and heat-treated steel.



M2 high-speed steel means a stronger durable industrial quality tool

135° split point allows faster aggressive cutting without "walking"

Titanium coating for superior performance with increased speed and feed applications plus extended drill bit life

DRILL BITS

Jobber Drill Bits (Carded)

DIAMETER	MODEL #	MIN. ORDER QTY.	PRODUCT CODE
1/16 2 Per Card	3251	5	E0102613
5/64 2 Per Card	3252	5	E0102614
3/32 2 Per Card	3253	5	E0102615
7/64 2 Per Card	3254	5	E0102616
1/8 2 Per Card	3255	5	E0102617
9/64	3256	5	E0102618
5/32	3257	5	E0102619
11/64	3258	5	E0102620
3/16	3259	5	E0102621
13/64	3260	5	E0102622
7/32	3261	5	E0102623
15/64	3262	5	E0102624
1/4	3263	5	E0102625
17/64	3264	5	E0102626
9/32	3265	5	E0102627
19/64	3266	5	E0102628
5/16	3267	5	E0102629
21/64	3268	5	E0102630
11/32	3269	5	E0102631
23/64	3270	5	E0102632
3/8	3271	5	E0102633
25/64 w/ 3/8 Shank	3272	5	E0102634
13/32 w/ 3/8 Shank	3273	5	E0102635
27/64 w/ 3/8 Shank	3274	5	E0102636
7/16 w/ 3/8 Shank	3275	5	E0102637
29/64 w/ 3/8 Shank	3276	5	E0102638
15/32 w/ 3/8 Shank	3277	5	E0102639
31/64 w/ 3/8 Shank	3278	5	E0102640
1/2 w/ 3/8 Shank	3279	5	E0102641



Jobber Drill Bits (Envelope)

DIAMETER	QTY. PER ENVELOPE	PRODUCT CODE
1/16	12	E0100912
5/64	12	E0100913
3/32	12	E0100914
7/64	12	E0100915
1/8	12	E0100916
9/64	12	E0100917
5/32	12	E0100918
11/64	12	E0100919
3/16	12	E0100920
13/64	12	E0100921
7/32	12	E0100922
15/64	12	E0100923
1/4	12	E0100924
17/64	12	E0100925
9/32	12	E0100926
19/64	6	E0100927
5/16	6	E0100928
21/64	6	E0100929
11/32	6	E0100930
23/64	6	E0100931
3/8	6	E0100932
25/64 w/ 3/8 Shank	6	E0100933
13/32 w/ 3/8 Shank	6	E0100934
27/64 w/ 3/8 Shank	6	E0100935
7/16 w/ 3/8 Shank	6	E0100936
29/64 w/ 3/8 Shank	6	E0100937
15/32 w/ 3/8 Shank	6	E0100938
31/64 w/ 3/8 Shank	6	E0100939
1/2 w/ 3/8 Shank	6	E0100940



BLU-MOL® TITANIUM DRILL BITS



Drill Bits – Sets

SET PIECE COUNT	MODEL #	MIN. ORDER QTY.	PRODUCT CODE
13PC: 1/16, 5/64, 3/32, 7/64, 1/8, 9/64, 5/32, 11/64, 3/16, 13/64, 7/32, 15/64, 15/64 and 1/4 in Plastic Drill Buddy with dial top.	3280	5	E0102642
21PC: 1/16, 5/64, 3/32, 7/64, 1/8, 9/64, 5/32, 11/64, 3/16, 13/64, 7/32, 15/64, 1/4, 17/64, 9/32, 19/64, 5/16, 21/64, 11/32, 23/64 and 3/8 plus Metal Index.	3281	5	E0102643
29PC: 1/16, 5/64, 3/32, 7/64, 1/8, 9/64, 5/32, 11/64, 3/16, 13/64, 7/32, 15/64, 1/4, 17/64, 9/32, 19/64, 5/16, 21/64, 11/32, 23/64, 3/8, 25/64*, 13/32*, 27/64*, 7/16*, 29/64*, 15/32*, 31/64* and 1/2* plus Metal Index. *3/8-in Reduced Shank.	3282	5	E0102644



20-Prong Jobber Drill Pegboard Display

DRILL WALL DISPLAY	PRODUCT CODE
Contains: (2) cards each of the following sizes: 1/16, 5/64, 3/32, 7/64, 1/8, 9/64, 5/32, 11/64, 3/16, 13/64, 7/32, 15/64, 1/4, 9/32, 5/16, 11/32, 3/8, 7/16 and 1/2, (2) of the 13PC Drill Buddy set, Header and 20-Prong Metal Rack (hangs from pegboard).	E0320102
DISPLAY COMPONENTS	PRODUCT CODE
20-Prong Metal Rack hangs from pegboard. (21" H x 23-1/4" W without product).	E4108190
Titanium Drill Bit Header (3" H x 23" W).	E2121334

23"-1/4" W (without product)



Countertop Bulk Bin

DRILL BIT ASSORTMENT / DISPLAY	PRODUCT CODE
Contains: Envelope with a quantity of (12) drills inside, of the following sizes: 1/16, 5/64, 3/32, 7/64, 1/8, 9/64, 5/32, 11/64, 3/16, 13/64, 7/32, 15/64, 1/4, 17/64 and 9/32; (6) drills per envelope: 19/64, 5/16, 21/64, 11/32, 23/64, 3/8, 25/64, 13/32, 27/64, 7/16, 29/64, 15/32, 31/64 and 1/2 and Bulk Metal Bin with slots referenced by size, drill gauge, header and keys.	E0320222
DISPLAY ONLY	PRODUCT CODE
Bulk Metal Bin for Drill Bits (Accommodates 29 drills, 1/16 through 1/2. Slots referenced by size. Drill gauge, header and 2 keys. Non-skid pads. Stickers on sides of bin detail how to select drill bits (9-1/4" H x 14-3/4" W x 8" D).	E0100362



COBALT DRILL BITS



Cobalt M35 drill bits provide superior specialized performance needed for extreme high heat encountered with drilling in hard metal, heat-treated steel and stainless steel.

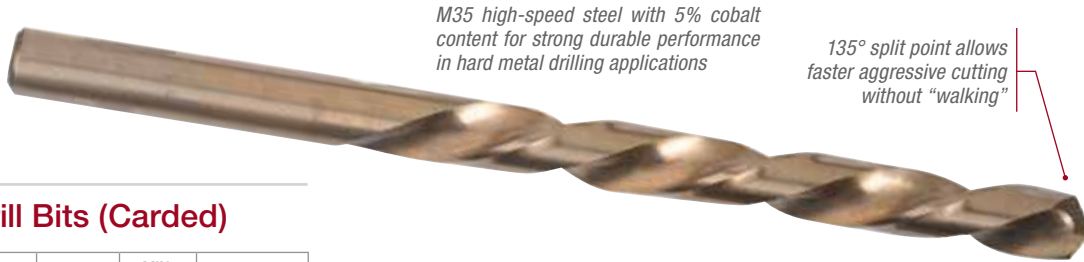

M35 high-speed steel with 5% cobalt content for strong durable performance in hard metal drilling applications

135° split point allows faster aggressive cutting without "walking"

Jobber Drill Bits (Carded)

DIAMETER	MODEL #	MIN. ORDER QTY.	PRODUCT CODE
1/16	3283	5	E0102645
5/64	3284	5	E0102646
3/32	3285	5	E0102647
7/64	3286	5	E0102648
1/8	3287	5	E0102649
9/64	3288	5	E0102650
5/32	3289	5	E0102651
11/64	3290	5	E0102652
3/16	3291	5	E0102653
13/64	3292	5	E0102654
7/32	3293	5	E0102655
15/64	3294	5	E0102656
1/4	3295	5	E0102657
17/64	3296	5	E0102658
9/32	3297	5	E0102659
19/64	3298	5	E0102660
5/16	3299	5	E0102661
21/64	3300	5	E0102662
11/32	3301	5	E0102663
23/64	3302	5	E0102664
3/8	3303	5	E0102665
25/64 w/ 3/8 Shank	3304	5	E0102666
13/32 w/ 3/8 Shank	3305	5	E0102667
27/64 w/ 3/8 Shank	3306	5	E0102668
7/16 w/ 3/8 Shank	3307	5	E0102669
29/64 w/ 3/8 Shank	3308	5	E0102670
15/32 w/ 3/8 Shank	3309	5	E0102671
31/64 w/ 3/8 Shank	3310	5	E0102672
1/2 w/ 3/8 Shank	3311	5	E0102673

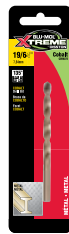

Carded



Model #3312



Model #3313



Model #3314

Drill Bits – Sets

SET PIECE COUNT	MODEL #	MIN. ORDER QTY.	PRODUCT CODE
13PC: 1/16, 5/64, 3/32, 7/64, 1/8, 9/64, 5/32, 11/64, 3/16, 13/64, 7/32, 15/64 and 1/4 in Plastic Drill Buddy with dial top.	3312	5	E0102674
21PC: 1/16, 5/64, 3/32, 7/64, 1/8, 9/64, 5/32, 11/64, 3/16, 13/64, 7/32, 15/64, 1/4, 17/64, 9/32, 19/64, 5/16, 21/64, 11/32, 23/64 and 3/8 plus Metal Index.	3313	5	E0102675
29PC: 1/16, 5/64, 3/32, 7/64, 1/8, 9/64, 5/32, 11/64, 3/16, 13/64, 7/32, 15/64, 1/4, 17/64, 9/32, 19/64, 5/16, 21/64, 11/32, 23/64, 3/8, 25/64*, 13/32*, 27/64*, 7/16*, 29/64*, 15/32*, 31/64* and 1/2* plus Metal Index. *3/8-in Reduced Shank.	3314	5	E0102676

20-Prong Jobber Drill Pegboard Display

DRILL WALL DISPLAY	PRODUCT CODE
Contains: (2) cards each of the following sizes: 1/16, 5/64, 3/32, 7/64, 1/8, 9/64, 5/32, 11/64, 3/16, 13/64, 7/32, 15/64, 1/4, 9/32, 5/16, 11/32, 3/8, 7/16, 1/2 and (2) of the 13PC Drill Buddy set, Header and 20-Prong Metal Rack (hangs from pegboard).	E4108190
DISPLAY COMPONENTS	PRODUCT CODE
20-Prong Metal Rack hangs from pegboard. (21" H x 23-1/4" W without product).	E0320103
Cobalt Drill Bit Header (3" H x 23" W).	E2121335

21" H



23-1/4" W (without product)

BLU-MOL® GLASS & TILE DRILL BITS

Glass and tile bits feature spade-shaped carbide tips for drilling holes in glass and tile substrates using a rotary power drill.



DIAMETER	MODEL #	MIN. ORDER QTY.	PRODUCT CODE
1/8	3430	5	E0102795
3/16	3431	5	E0102796
1/4	3432	5	E0102797
5/16	3433	5	E0102798
3/8	3434	5	E0102799
1/2	3435	5	E0102800
4PC: 1/8, 3/16, 1/4 and 5/16	3436	5	E0102801



QUAD-TIPPED GLASS & TILE DRILL BITS

Blu-Mol Xtreme® glass & tile bits feature quad-tipped carbide tips which improve durability, accuracy and speed above standard glass & tile bits.



Polished bright finish provides maximum dust ejection

Solid high-grade tungsten carbide quad-tipped creates smooth holes



DIAMETER	MODEL #	MIN. ORDER QTY.	PRODUCT CODE
3/16	4430	6	E0104969
1/4	4431	6	E0104970
5/16	4432	6	E0104971
3/8	4433	6	E0104972
1/2	4434	6	E0104973
5/8	4435	6	E0104974
3/4	4436	6	E0104975
1	4437	6	E0104976



MASONRY DRILL BITS

For drilling into masonry, concrete, rock and stone.



For rotary or impact drills

Carbide tip



Clamshelled

DIAMETER & LENGTH	MODEL #	MIN. ORDER QTY.	PRODUCT CODE
1/4 x 13	3423	5	E0102760
5/16 x 13	3424	5	E0102761
3/8 x 13	3425	5	E0102762
1/2 x 13 w/ 3/8 shank	3426	5	E0102763
5/8 x 13 w/ 1/2 shank	3427	5	E0102764
3/4 x 13 w/ 1/2 shank	3428	5	E0102765
7PC: 1/8 x 4, 5/32 x 4 (2), 3/16 x 6 (2), 1/4 x 6, 3/8 x 6 in plastic case.	3429	1	E0102766



Carded

DIAMETER & LENGTH	MODEL #	MIN. ORDER QTY.	PRODUCT CODE
1/8 x 3	3407	5	E0102744
5/32 x 3	3408	5	E0102745
5/32 x 3, 3 per card	3409	5	E0102746
3/16 x 4	3410	5	E0102747
3/16 x 4, 3 per card	3411	5	E0102748
1/4 x 4	3412	5	E0102749
1/4 x 4, 3 per card	3413	5	E0102750
5/16 x 4	3414	5	E0102751
3/8 x 4	3415	5	E0102752
1/2 x 4 w/ 3/8 shank	3416	5	E0102753
1/4 x 6	3417	5	E0102754
5/16 x 6	3418	5	E0102755
3/8 x 6	3419	5	E0102756
1/2 x 6 w/ 3/8 shank	3420	5	E0102757
5/8 x 6 w/ 1/2 shank	3421	5	E0102758
3/4 x 6 w/ 1/2 shank	3422	5	E0102759



SPADE BITS

Spade bits quickly cut holes in wood. Most commonly used for rough-in work, spade bits can be used for any wood hole drilling job to quickly cut a 1/4 to 1-1/2 hole.

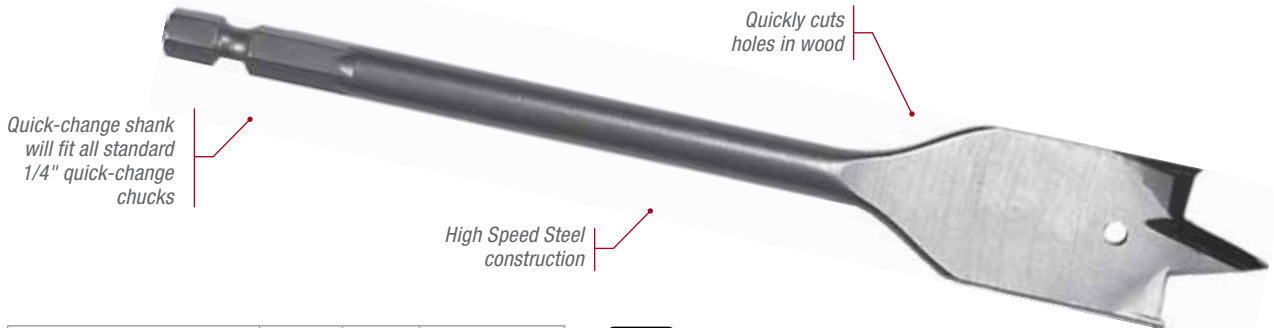

DIAMETER & LENGTH	MODEL #	MIN. ORDER QTY.	PRODUCT CODE
Spade Bits (Carded)			
3/8 x 4	3372	5	E0102702
1/2 x 4	3373	5	E0102703
5/8 x 4	3374	5	E0102704
3/4 x 4	3375	5	E0102705
7/8 x 4	3376	5	E0102706
1 x 4	3377	5	E0102707
1-1/4 x 4	3378	5	E0102708
1-1/2 x 4	3379	5	E0102709
1/4 x 6	3380	5	E0102710
5/16 x 6	3381	5	E0102711
3/8 x 6	3382	5	E0102712
7/16 x 6	3383	5	E0102713
1/2 x 6	3384	5	E0102714
9/16 x 6	3385	5	E0102715
5/8 x 6	3386	5	E0102716
11/16 x 6	3387	5	E0102717
3/4 x 6	3388	5	E0102718
13/16 x 6	3389	5	E0102719
7/8 x 6	3390	5	E0102720
15/16 x 6	3391	5	E0102721
1 x 6	3392	5	E0102722
1-1/8 x 6	3393	5	E0102723
1-1/4 x 6	3394	5	E0102724
1-3/8 x 6	3395	5	E0102725
1-1/2 x 6	3396	5	E0102726
3/8 x 16	3397	5	E0102727
1/2 x 16	3398	5	E0102728
5/8 x 16	3399	5	E0102729
3/4 x 16	3400	5	E0102730
7/8 x 16	3401	5	E0102731
1 x 16	3402	5	E0102732
Bit - Sets			
4PC: 1/2, 3/4 and 1 bits each 4" in length with 6" QC extension	3403	5	E0102733
8PC: 3/8, 1/2, 5/8, 3/4, 7/8, 1, 1-1/4 and 1-1/2 bits each 6" in length in plastic case	3404	1	E0102734



Model #3403



Model #3404

20-Prong Spade Bit Pegboard Display

BIT WALL DISPLAY	PRODUCT CODE
Contains: (2) cards each of the following sizes 6" in length: 1/4, 5/16, 3/8, 7/16, 1/2, 9/16, 5/8, 11/16, 3/4, 13/16, 7/8, 15/16, 1, 1-1/8, 1-1/4, 1-3/8, 1-1/2, 6 extension and (4) of the 4PC Bit Set, Header and 20-Prong Metal Rack (hangs from pegboard).	E0320104
DISPLAY COMPONENTS	PRODUCT CODE
20-Prong Metal Rack hangs from pegboard. (21" H x 23-1/4" W without product).	E4108190
Spade Bit Header (3" H x 23-1/4" W).	E2121336



21" H

23"-1/4" W (without product)

Blu-Mol® 1/4" Extensions (Carded)

For drilling long holes and use in hard-to-reach places.

LENGTH	MODEL #	MIN. ORDER QTY.	PRODUCT CODE
6	3405	5	E0102735
12	3406	5	E0102736



BLU-MOL® SCREW EXTRACTORS

For extracting screws and bolts with broken or damaged heads. For use with a tap or reamer wrench.



DESCRIPTION	MODEL #	MIN. ORDER QTY.	PRODUCT CODE
#1 (Removal of 3/32" - 5/32" screws/bolts)	6395	6	E0104960
#2 (Removal of 5/32" - 7/32" screws/bolts)	6396	6	E0104961
#3 (Removal of 7/32" - 9/32" screws/bolts)	6397	6	E0104962
#4 (Removal of 9/32" - 3/8" screws/bolts & 1/8" pipe)	6398	6	E0104963
#5 (Removal of 3/8" - 5/8" screws/bolts & 1/4" pipe)	6399	6	E0104964



POWER WOOD BORING BITS

Unique flute design ensures faster chip ejection. The bits are fully heat treated for increased durability. Use for all general drilling in wood.



Model #3607



Model #3608

DIAMETER & LENGTH	MODEL #	MIN. ORDER QTY.	PRODUCT CODE
1/2 x 6 1/2	3600	5	E0119054
9/16 x 6 1/2	3601	5	E0119055
5/8 x 6 1/2	3602	5	E0119056
3/4 x 6 1/2	3603	5	E0119057
7/8 x 6 1/2	3604	5	E0119058
1 x 6 1/2	3605	5	E0119059
1-1/4 x 6 1/2	3606	5	E0119060
3PC: 5/8 (2) and 3/4 bits each 6-1/2" in length	3607	5	E0119061
6PC: 1/2, 5/8, 3/4, 7/8, 1 and 1-1/4 each 6-1/2" in length in compact armor case	3608	5	E0119062

BLU-MOL® COUNTERSINKS

For countersinking, deburring and chamfering in wood, soft metal, plastic and other machinable materials.



DIAMETER	MODEL #	MIN. ORDER QTY.	PRODUCT CODE
1/4	5356	5	E0106155
3/8	5357	5	E0106156
1/2	5358	5	E0106157
5/8	5359	5	E0106158
3/4	5360	5	E0106159

BLU-MOL® DRILL/COUNTERSINKS

For drilling, countersinking and counterboring in one operation. Can be used on wood or composite material. Twist drill adjusts to any screw length.



Model #6211

DESCRIPTION	DIAMETER	MODEL #	MIN. ORDER QTY.	PRODUCT CODE
For #6 Woodscrews	3/32	6207	5	E0106162
For #8 Woodscrews	7/64	6208	5	E0106163
For #10 Woodscrews	1/8	6209	5	E0106164
For #12 Woodscrews	9/64	6210	5	E0106165
4PC: 3/32, 7/64, 1/8 and 9/64	--	6211	5	E0106166

HOLE SAW INDEX

Disston offers a wide range of hole saw types and sizes to fit your job. Hole saws and accessories are available in individual packaging and convenient sets.

HOLE SAWS



Blu-Mol Xtreme® Bi-Metal

Features a revolutionary design that increases visibility, accuracy and improves battery and machine life. Diamond-shaped sidewall cutouts increase visibility while large openings on the backing plate allow for quick removal of cut materials. Fleem ground teeth for longer life.

Blu-Mol® Bi-Metal

Features high speed steel teeth for a sharper and longer lasting tool. Suitable for both wood and metal cutting.

Blu-Mol® Sheet Metal

Special eight teeth per inch ensures smoother cuts in sheet metal. Made to work with impact drivers. Ideal for the electrical tradesman.

Blu-Mol® and Blu-Mol Xtreme® Tungsten Carbide Tipped Hole Cutters

Cutting is based on new metal cutting technology. Tungsten Carbide Tip (TCT) cuts holes in thick metals for very fast boring. Available in Tri-Cut and Standard styles.

Blu-Mol Xtreme® Carbide Tipped

Efficiently cuts abrasive materials with greater heat and wear resistance than bi-metal saws. Three teeth per inch delivers aggressive cut.

Blu-Mol® Carbon Steel

Patented arbored design is packaged in clamshells. Hole saws also available in convenient sets. Specifically developed for the occasional user.

RemGrit® Carbide Grit

Carbide grit offers the greatest wear and heat resistance. Ideal for materials that other saws will not cut, this saw cuts extremely abrasive materials with no teeth to chip or dull.

RemGrit® Carbide Grit Recessed Light Installation Kit

Carbide grit cutting edge easily cuts through ceiling tile and drywall. Everything you need to install recessed lighting fixtures fast.



METAL CUTTING SAFETY

READ THIS BEFORE USING PRODUCTS

Modern metal cutting operations involve high energy, high spindle or cutter speeds, and high temperatures and cutting forces. Hot, flying chips may be projected from the workpiece during metal cutting. Although advanced cutting tool materials are designed and manufactured to withstand the high cutting forces and temperatures that normally occur in these operations, they are susceptible to fragmenting in service, particularly if they are subjected to over-stress, severe impact or otherwise abused.

Therefore, precautions should be taken to adequately protect workers, observers and equipment against hot, flying chips, fragmented cutting tools, broken workpieces or other similar projectiles. Machines should be fully guarded and personal protective equipment should be used at all times.

Disston has no control over the end use of its products or the environment into which those products are placed. Disston urges that its customers adhere to the

recommended standards of use of their metal cutting operations. The information included throughout this catalog under the heading "Technical Data" and other recommendations on machining practices referred to herein are only advisory in nature and do not constitute representations or warranties and are not necessarily appropriate for any particular work environment or application.

TECH TIPS FOR HOLE SAWS



- Always wear eye protection.
- Always be sure that the pilot drill extends beyond the cutting edge of the saw by at least 1/8".
- Be sure to secure the material to be cut to keep it from spinning or slipping.
- Be sure to start the cutting process with the saw square to the material being cut. This will ensure that all teeth begin to cut at the same time and will help prevent premature wear and damage to the saw.
- Be sure to follow the recommended operating speed for the saw size and the material being cut.
- Operator should feed the saw in and out to allow the material shavings to clear out of the hole being cut.
- Cutting oils or lubricants should be used to extend the life of the saw, except when cutting wood or cast iron.
- Occasionally check the mandrel's drive pins to be sure they are still fully engaged in the saw and that they have not vibrated out of the drive holes in the saw.
- When sawing in wood, finish the hole from the opposite side to prevent splintering. Once the pilot drill has broken through the other side, you can use this hole to guarantee you are in line with where you have already started cutting.
- When sawing resistant and difficult to cut materials, drill a couple of small holes on the circumference to allow chips to clear.
- Keep an oil soaked sponge inside the hole saw if you:
 - Cannot lubricate in the normal way
 - Operate in stainless steel
 - Operate in a vertical position from above

TECH TIPS FOR PIPE TAP & PIPE ENTRANCE



- Pipe Taps are used for threading holes created by a hole saw to receive a threaded pipe. Reference the product charts for proper selection. To cut a hole for a 1" pipe tap, select a 1-1/8" hole saw.
- Pipe Entrance is the diameter for the hole through which a pipe of a given diameter will pass during installation or repair.
- Pipe Size is defined by the inside diameter. Reference chart on next page for proper selection. To cut a hole through which a 3/4" pipe may be passed, a 1-1/8" hole saw is used.
- Tubing Size is defined by the outside diameter. To cut an entrance hole of a given tubing diameter, the same diameter hole saw should be used.

HOLE SAW SIZE REFERENCE CHART

DIAMETER		PIPE TAP DIAMETER		PIPE ENTRANCE DIAMETER		XTREME	BLU-MOL	SHEET METAL	XTREME TRI-CUT TCT	STD TCT	XTREME CARBIDE TIPPED	CARBON ARBORED	REMGKIT	REMGKIT ARBORED
INCHES	MM	INCHES	MM	INCHES	MM									
9/16	14	--	--	--	--	5855B	509			3164				
5/8	16	--	--	--	--	5856B	510	6918		3165			G010M	
11/16	17	--	--	--	--	5857B	511		3141	3166	C11			
3/4	19	1/2	13	3/8	10	5127B	512	6919	3142	3167	C12		G012	
--	20	--	--	--	--	5888B	M513	6920	3205	3206			G013M	
13/16	21	--	--	--	--	5858B	513		3143	3168				
7/8	22	3/4	19	1/2	13	5128B	514	6921	3144	3169	C14		G014	
15/16	24	--	--	--	--	5859B	515		3145	3170				
1	25	--	--	--	--	5197B	516	6922	3146	3171	C16	6501	G016	OGC16BL
1-1/16	27	--	--	--	--	5860B	517	6923	3147	3172				
1-1/8	29	1	25	3/4	19	5130B	518	6924	3148	3173	C18		G018	
1-3/16	30	--	--	--	--	5861B	519	6925	3149	3174				
1-1/4	32	--	--	--	--	5131B	520	6926	3150	3175	C20	6502	G020	OGC20BL
1-5/16	33	--	--	--	--	5862B	521		3151	3176				
1-3/8	35	--	--	1	25	5132B	522	6927	3152	3177	C22		G022	
1-7/16	37	--	--	--	--	5863B	523		3153	3178				
1-1/2	38	1-1/4	32	--	--	5198B	524	6928	3154	3179	C24	6503	G024	OGC24BL
1-9/16	40	--	--	--	--	5864B	525		3155	3180				
1-5/8	41	--	--	--	--	5133B	526		3156	3181	C26			
1-11/16	43	--	--	--	--	5865B	527		3157	3182				
1-3/4	44	1-1/2	38	1-1/4	32	5134B	528		3158	3183	C28	6504	G028	OGC28BL
--	45	--	--	--	--	M5134B	M528							
1-13/16	46	--	--	--	--	5866B	529		3159	3184				
1-7/8	48	--	--	--	--	5135B	530		3160	3185			G030	
--	49	--	--	--	--				3161	3186				
--	50	--	--	--	--	M5136B	M532							
2	51	--	--	1-1/2	38	5136B	532		3162	3187	C32	6506	G032	OGC32BL
2-1/16	52	--	--	--	--	5867B	533			3188				
2-1/8	54	--	--	--	--	5199B	534			3189	C34	6507	G034	OGC34BL
--	55	--	--	--	--	M5199B	M534							
--	56	--	--	--	--					3190				
2-1/4	57	2	51	--	--	5137B	536			3191	C36	6508	G036	OGC36BL
2-5/16	59	--	--	--	--	5868B	537			3192				
2-3/8	60	--	--	--	--	5139B	538			3193	C38		G038	
2-7/16	62	--	--	--	--					3194				
2-1/2	64	--	--	2	51	5138B	540			3195	C40	6509	G040	OGC40BL
2-9/16	65	--	--	--	--	5869B	541			3196	C41			
2-5/8	67	2-1/2	64	--	--	5870B	542			3197	C42			
--	68	--	--	--	--	M5149B	M542			3198				
2-3/4	70	--	--	--	--	5871B	544			3199			G044	
2-7/8	73	--	--	--	--	5872B	546			3201				
--	75	--	--	--	--	M5150B	M548							
3	76	--	--	2-1/2	64	5150B	548			3203	C48		G048	
3-1/8	79	--	--	--	--	5873B	550							
3-1/4	83	3	76	--	--	5874B	552				C52		G052	
3-3/8	86	--	--	--	--	5875B	554				C54		G054	
3-1/2	89	--	--	--	--	5151B	556				C56			
3-5/8	92	--	--	3	76	5876B	558				C58			
3-3/4	95	3-1/2	89	--	--	5877B	560				C60		G060	
3-7/8	98	--	--	--	--	5878B	562							
--	100	--	--	--	--	M5152B	M564							
4	102	--	--	--	--	5152B	564				C64		G064	
4-1/8	105	--	--	3-1/2	89	5879B	566				C66			
4-1/4	108	4	102	--	--	5880B	568				C68			
4-3/8	111	--	--	--	--	5881B	570							
4-1/2	114	--	--	--	--	5153B	572				C72		G072	
4-3/4	121	4-1/2	114	4	102	5882B	576				C76			
5	127	--	--	--	--	5154B	580				C80			
5-1/2	140	--	--	5	127	5155B	588				C88			
5-3/4	146	--	--	--	--	5883B	592							
6	152	--	--	--	--	5156B	596				C96			



RECOMMENDED OPERATING SPEEDS FOR HOLE SAWS AND CUTTERS

These guidelines are provided by Disston Company as information on the generally recommended operating speeds for hole saws and cutters. Disston Company recommends that users always follow the specific recommendations of the hole saw manufacturer concerning hole saw and cutter use and operating speeds.

Bi-Metal Hole Saw Operating Speeds (RPM Table)

INCHES	MM	LENGTH (FT)	MILD STEEL	TOOL STEEL & STAINLESS	CAST IRON	BRASS	ALUMINUM	WOOD
9/16	14	0.147	580	300	400	790	900	3000
5/8	16	0.164	550	275	365	730	825	3000
11/16	17	0.180	500	250	330	665	750	3000
3/4	19	0.196	460	230	300	600	690	3000
-	20	0.213	440	220	290	580	660	3000
7/8	22	0.229	390	195	260	520	585	3000
1	25	0.262	350	175	235	470	525	2700
1 1/16	27	0.278	325	160	215	435	480	2700
1 1/8	29	0.295	300	150	200	400	450	2700
1 3/16	30	0.311	285	145	190	380	425	2400
1 1/4	32	0.327	275	140	180	360	410	2400
1 5/16	33	0.344	260	135	175	345	390	2400
1 3/8	35	0.360	250	125	165	330	375	2400
1 7/16	37	0.376	240	120	160	315	360	2400
1 1/2	38	0.393	230	115	150	300	345	2400
1 9/16	40	0.409	220	110	145	290	330	2100
1 5/8	41	0.425	210	105	140	280	315	2100
1 11/16	43	0.442	205	100	135	270	305	2100
1 3/4	44	0.458	195	95	130	260	295	2100
1 13/16	46	0.475	190	95	125	250	285	2100
1 7/8	48	0.491	180	90	120	240	270	2100
2	51	0.524	170	85	115	230	255	2000
2 1/16	52	0.540	165	80	110	220	245	2000
2 1/8	54	0.556	160	80	105	210	240	2000
2 1/4	57	0.589	150	75	100	200	225	2000
2 5/16	59	0.605	145	75	95	195	225	2000
2 3/8	60	0.622	140	70	90	190	220	2000
2 1/2	64	0.655	135	65	85	180	205	1850
2 9/16	65	0.671	130	65	85	175	200	1850
2 5/8	67	0.687	130	65	85	170	195	1800
-	68	0.704	130	65	80	170	190	1800
2 3/4	70	0.720	125	60	80	160	185	1800
2 7/8	73	0.753	120	60	75	160	180	1800
3	76	0.785	115	55	70	150	170	1800
3 1/8	79	0.818	110	55	70	140	165	1500
3 1/4	83	0.851	105	50	65	140	155	1500
3 3/8	86	0.884	100	50	65	130	150	1500
3 1/2	89	0.916	95	45	60	130	145	1200
3 5/8	92	0.949	90	45	60	120	140	1200
3 3/4	95	0.982	90	45	60	120	135	1200
3 7/8	98	1.014	90	45	60	120	135	1200
4	102	1.047	85	40	55	110	130	1000
4 1/8	104	1.080	80	40	55	110	120	1000
4 1/4	108	1.113	80	40	55	110	120	900
4 3/8	111	1.145	80	40	50	100	120	900
4 1/2	114	1.178	75	35	50	100	105	900
4 3/4	121	1.244	75	35	50	92	95	900
5	127	1.309	65	30	45	90	90	800
5 1/2	140	1.440	60	25	40	85	85	800
5 3/4	146	1.505	55	25	35	75	75	800
6	152	1.571	55	25	35	75	75	800

Blu-Mol® and Xtreme® TCT Cutter Operating Speeds (RPM Table)

DIAMETER		MATERIAL	
INCHES	MM	STEEL	STAINLESS STEEL
11/16 to 13/16	18mm to 21mm	700-1000	300-700
7/8 to 1-3/16	22mm to 30mm	500-800	200-450
1-1/4 to 1-9/16	31mm to 40mm	300-600	175-315
1-5/8 to 2	41mm to 50mm	200-500	120-225
2-1/16 to 2-3/8	51mm to 60mm	200-400	95-195
2-7/16 to 3	61mm to 76mm	150-300	80-150

RemGrit® Hole Saw Operating Speeds (RPM Table)

INCHES	MM	BRICK CERAMIC	SLATE	REINFORCED PLASTICS	FIBERGLASS
5/8	16	620	1540	2140	920
3/4	19	510	1280	1790	770
-	20	470	1180	1660	715
7/8	22	430	1090	1530	660
1	25	380	960	1340	580
1 1/8	29	340	850	1190	510
1 1/4	32	310	770	1070	460
1 3/8	35	280	700	980	420
1 1/2	38	260	640	890	390
1 3/4	44	220	550	770	330
1 7/8	48	200	510	720	310
2	51	190	480	670	290
2 1/8	54	180	450	630	280
2 1/4	57	170	430	600	270
2 3/8	60	160	400	570	250
2 1/2	64	150	380	540	230
2 3/4	70	140	350	500	210
3	76	130	320	450	190
3 1/4	83	120	295	415	180
3 3/8	86	115	285	400	175
3 3/4	95	102	255	350	160
4	102	95	240	330	150
4 1/2	114	82	215	290	125

HOLE SAWS

BI-METAL HOLE SAWS

Large openings on the backing plate allow for quick removal of cut materials. The diamond-shaped sidewall cutouts increase visibility while cutting. Patented design.

HOLE SAWS
Clamshelled

DIAMETER		MODEL #	PRODUCT CODE
INCHES	MM		
9/16	14	5855B	E0211309
5/8	16	5856B	E0211311
11/16	17	5857B	E0211312
3/4	19	5127B	E0212714
25/32	20	5888B	E0211342
13/16	21	5858B	E0211313
7/8	22	5128B	E0210492
15/16	24	5859B	E0211314
1	25	5197B	E0210642
1-1/16	27	5860B	E0211315
1-1/8	29	5130B	E0210509
1-3/16	30	5861B	E0211316
1-1/4	32	5131B	E0210511
1-5/16	33	5862B	E0211317
1-3/8	35	5132B	E0210513
1-7/16	37	5863B	E0211318
1-1/2	38	5198B	E0210644
1-9/16	40	5864B	E0211319
1-5/8	41	5133B	E0210515
1-11/16	43	5865B	E0211320
1-3/4	44	5134B	E0210517
--	45	M5134B	E0214033
1-13/16	46	5866B	E0211321
1-7/8	48	5135B	E0210519
--	50	M5136B	E0214034
2	51	5136B	E0210521
2-1/16	52	5867B	E0211322
2-1/8	54	5199B	E0210646
--	55	M5199B	E0214035
2-1/4	57	5137B	E0210523
2-5/16	59	5868B	E0211323
2-3/8	60	5139B	E0210527
2-1/2	64	5138B	E0210525
2-9/16	65	5869B	E0211324
2-5/8	67	5870B	E0211325
--	68	M5149B	E0212405
2-3/4	70	5871B	E0211327
2-7/8	73	5872B	E0211328
--	75	M5150B	E0214036
3	76	5150B	E0210560
3-1/8	79	5873B	E0211329
3-1/4	83	5874B	E0211330
3-3/8	86	5875B	E0211331
3-1/2	89	5151B	E0210562
3-5/8	92	5876B	E0211332
3-3/4	95	5877B	E0211333
3-7/8	98	5878B	E0211334
--	100	M5152B	E0214037
4	102	5152B	E0210564
4-1/8	105	5879B	E0211335
4-1/4	108	5880B	E0211336
4-3/8	111	5881B	E0211337
4-1/2	114	5153B	E0210566
4-3/4	121	5882B	E0211338
5	127	5154B	E0210567
5-1/2	140	5155B	E0210568
5-3/4	146	5883B	E0211339
6	152	5156B	E0210569

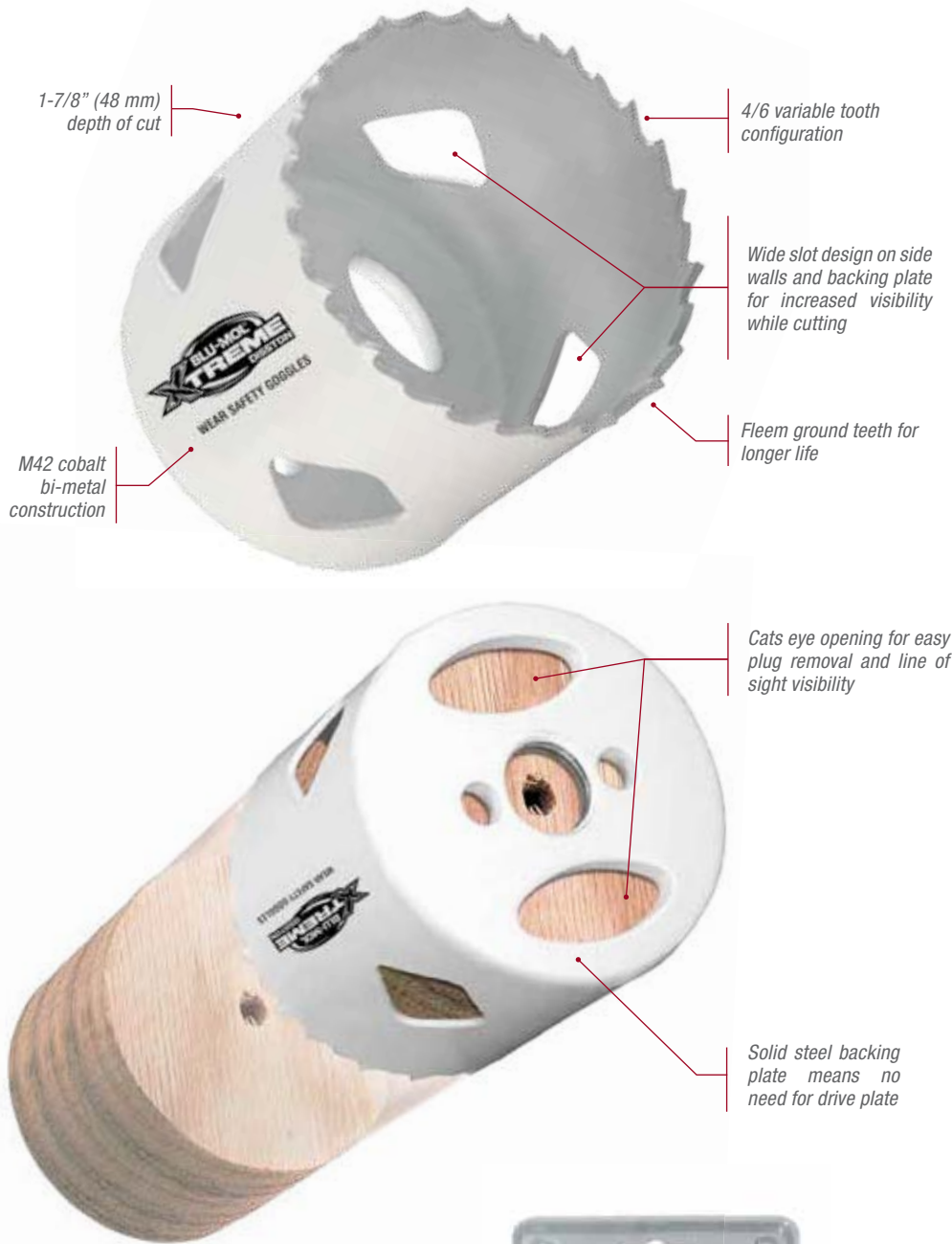

UP TO **24% LONGER LIFE**





BI-METAL HOLE SAW DISPLAY



Unique point-of-purchase merchandiser to maximize your sale. Everything you need to get started, including header, vinyl, peg hooks and 2 pieces of each product.

Blu-Mol Xtreme® Bi-Metal Hole Saw Display

SAW WALL DISPLAY	PRODUCT CODE
Contains: (2) cards each of the following sizes: 5/8", 3/4", 7/8", 1", 1-1/16", 1-1/8", 1-1/4", 1-3/8", 1-1/2", 1-5/8", 1-3/4", 1-7/8", 2", 2-1/8", 2-1/4", 2-1/2", 2-5/8", 3", 3-1/4", 3-1/2", 3-5/8", 3-3/4", 4", 4-1/8", 4-1/2", 4-3/4", 5", 6", Mandrel (No Pin), Mandrel w/Pin, Adapter/Washer and Pilot (5 per card), (2) journeymen's kits.	E0320098
DISPLAY COMPONENTS	PRODUCT CODE
Hole Saw Display Vinyl (34" H x 30-1/2" W)	E2121331
Hole Saw Display Header (10" H x 30-1/2" W)	E2121330
4" Peg Hooks (Bag of 39)	E2121332



E0320098
Dimensions: 44" H x 30-1/2" W

HOLE SAWS

Blu-Mol Xtreme® Bi-Metal Hole Saw Kits

KIT DESCRIPTION	MODEL #	PRODUCT CODE
7 Pc. Handyman's Kit Kit Includes: 5 Hole Saws: 7/8"(22mm), 1"(25mm), 1-1/8"(29mm), 1-1/4"(32mm), 1-1/2"(38mm); Mandrel (1), Mandrel Adapter (1), in Heavy Duty Case.	D9595	E0212169
9 Pc. Locksmith's Kit Kit Includes: 6 Hole Saws: 7/8"(22mm), 1"(25mm), 1-1/4"(32mm), 1-1/2"(38mm), 1 3/4"(44mm), 2-1/8"(54mm); Mandrels (2), Mandrel Adapter (1), in Heavy Duty Case.	D9591	E0212165
9 Pc. Plumber's Kit Kit Includes: 6 Hole Saws: 3/4"(19mm), 7/8"(22mm), 1-1/8"(29mm), 1-1/2"(38mm), 1-3/4"(44mm), 2-1/4"(57mm); Mandrels (2), Mandrel Adapter (1), in Heavy Duty Case.	D9592	E0212166
9 Pc. Electrician's Kit Kit Includes: 6 Hole Saws: 7/8"(22mm), 1-1/8"(29mm), 1-3/8"(35mm), 1-3/4"(44mm), 2"(51mm), 2-1/2"(64mm); Mandrels (2), Mandrel Adapter (1), in Heavy Duty Case.	D9593	E0212167
9 Pc. Electrician's Kit - Metric Kit Includes: 6 Hole Saws: 16mm (5/8"), 20mm, 25mm (1"), 32mm (1-1/4"), 40mm (1-9/16"), 51mm (2"); Mandrels (2), Mandrel Adapter (1), in Heavy Duty Case.	D9593M	E0212168
13 Pc. Journeyman's Kit Kit Includes: 9 Hole Saws: 3/4"(19mm), 7/8"(22mm), 1-1/8"(29mm), 1-3/8"(35mm), 1-1/2"(38mm), 1-3/4"(44mm), 2"(51mm), 2-1/4"(57mm), 2-1/2"(64mm); Mandrels (2), Mandrel Adapter (1), Pilot Drill (1), in Heavy Duty Case.	D9596	E0212170
20 Pc. Industrial Kit Kit Includes: 15 Hole Saws: 3/4"(19mm), 7/8"(22mm), 1-1/8"(29mm), 1-3/8"(35mm), 1-1/2"(38mm), 1-3/4"(44mm), 2"(51mm), 2-1/4"(57mm), 2-1/2"(64mm), 3"(76mm), 3-1/4"(83mm), 3-5/8"(92mm), 3-3/4"(95mm), 4-1/8"(105mm), 4-1/2"(114mm), Mandrels (2), Mandrel Adapter (1), Pilot Drill (1), 12" Extension (1), in Heavy Duty Steel Case.	D9599	E0212171



BLU-MOL® BI-METAL HOLE SAWS

M42 cobalt bi-metal cutting edge provides shock resistant teeth and resists tooth strippage.
4/6 positive tooth configuration allows for fast, smooth cuts and less vibration.



Blu-Mol® Bi-Metal Hole Saws (Boxed)

DIAMETER		MODEL #	PRODUCT CODE
INCHES	MM		
9/16	14	509	E0102399
5/8	16	510	E0102400
11/16	17	511	E0102401
3/4	19	512	E0102402
25/32	20	M513	E0102403
13/16	21	513	E0102404
7/8	22	514	E0102405
15/16	24	515	E0102406
1	25	516	E0102407
1-1/16	27	517	E0102408
1-1/8	29	518	E0102409
1-3/16	30	519	E0102410
1-1/4	32	520	E0102411
1-5/16	33	521	E0102412
1-3/8	35	522	E0102413
1-7/16	37	523	E0102414
1-1/2	38	524	E0102415
1-9/16	40	525	E0102416
1-5/8	41	526	E0102417
1-11/16	43	527	E0102418
1-3/4	44	528	E0102419
--	45	M528	E0102420
1-13/16	46	529	E0102421
1-7/8	48	530	E0102422
--	50	M532	E0102423
2	51	532	E0102424
2-1/16	52	533	E0102425
2-1/8	54	534	E0102426
--	55	M534	E0102427
2-1/4	57	536	E0102428
2-5/16	59	537	E0102429
2-3/8	60	538	E0102430
2-1/2	64	540	E0102431
2-9/16	65	541	E0102432
2-5/8	67	542	E0102433
--	68	M542	E0102434
2-3/4	70	544	E0102435
2-7/8	73	546	E0102436
--	75	M548	E0102437
3	76	548	E0102438
3-1/8	79	550	E0102439
3-1/4	83	552	E0102440
3-3/8	86	554	E0102441
3-1/2	89	556	E0102442
3-5/8	92	558	E0102443
3-3/4	95	560	E0102444
3-7/8	98	562	E0102445
--	100	M564	E0102446
4	102	564	E0102447
4-1/8	105	566	E0102448
4-1/4	108	568	E0102449
4-3/8	111	570	E0102450
4-1/2	114	572	E0102451
4-3/4	121	576	E0102452
5	127	580	E0102453
5-1/2	140	588	E0102454
5-3/4	146	592	E0102455
6	152	596	E0102456

HOLE SAWS

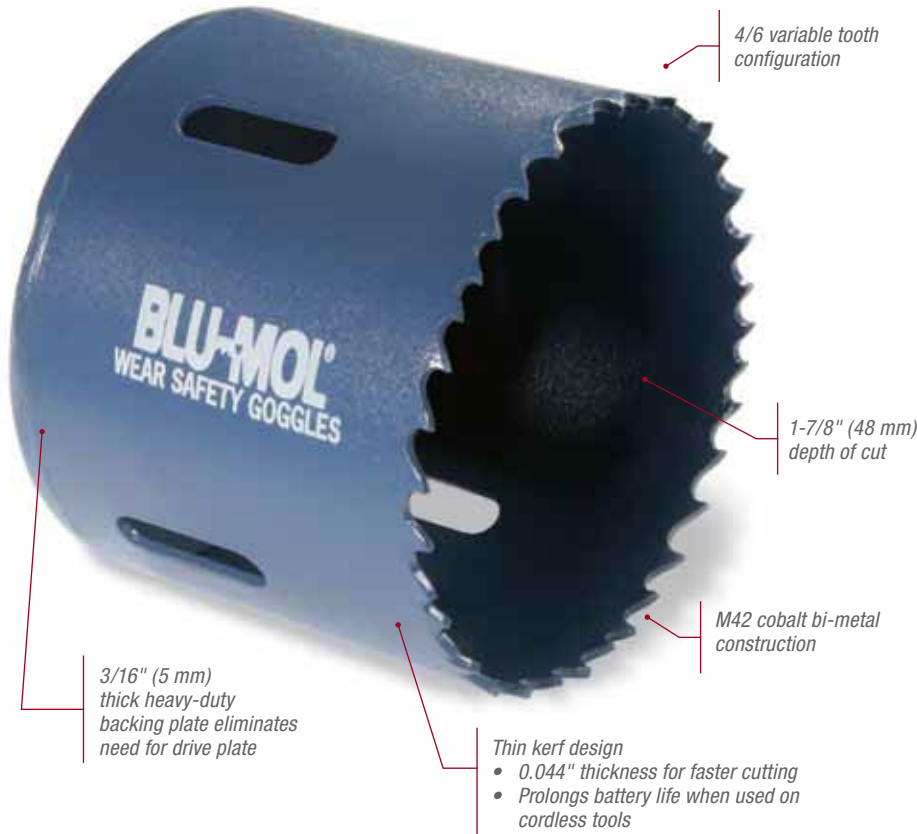

3/16" (5 mm) thick heavy-duty backing plate eliminates need for drive plate

Thin kerf design

- 0.044" thickness for faster cutting
- Prolongs battery life when used on cordless tools



UP TO **24% LONGER LIFE**





BLU-MOL® BI-METAL HOLE SAW DISPLAY

Unique point-of-purchase merchandiser to maximize your sale. Everything you need to get started, including header, vinyl, peg hooks and 2 pieces of each product.



Blu-Mol® Bi-Metal Hole Saw Display

SAW WALL DISPLAY	PRODUCT CODE
Contains: (2) cards each of the following sizes: 5/8", 3/4", 7/8", 1", 1-1/16", 1-1/8", 1-1/4", 1-3/8", 1-1/2", 1-5/8", 1-3/4", 1-7/8", 2", 2-1/8", 2-1/4", 2-1/2", 2-5/8", 3", 3-1/4", 3-1/2", 3-5/8", 3-3/4", 4", 4-1/8", 4-1/2", 4-3/4", 5", 6", Mandrel (No Pin), Mandrel w/Pin, Adapter/Washer and Pilot (5 per card).	E0320097
DISPLAY COMPONENTS	PRODUCT CODE
Hole Saw Display Vinyl (34" H x 30-1/2" W)	E2121633
Hole Saw Display Header (10" H x 30-1/2" W)	E2121253
4" Peg Hooks (Bag of 36)	E2121641



E0320097
Dimensions: 32" x 39" (813mm x 991mm)

Blu-Mol® Bi-Metal Hole Saw Kits

KIT DESCRIPTION	MODEL #	PRODUCT CODE
7 Pc. Handyman's Kit Kit Includes: 5 Hole Saws: 7/8"(22mm), 1"(25mm), 1-1/8"(29mm), 1-1/4"(32mm), 1-1/2"(38mm); Mandrel (1), Mandrel Adapter (1), in Heavy Duty Case.	9595	E0103111
9 Pc. Locksmith's Kit Kit Includes: 6 Hole Saws: 7/8"(22mm), 1"(25mm), 1-1/4"(32mm), 1-1/2"(38mm), 1 3/4"(44mm), 2-1/8"(54mm); Mandrels (2), Mandrel Adapter (1), in Heavy Duty Case.	9591	E0103112
9 Pc. Plumber's Kit Kit Includes: 6 Hole Saws: 3/4"(19mm), 7/8"(22mm), 1-1/8"(29mm), 1-1/2"(38mm), 1-3/4"(44mm), 2-1/4"(57mm); Mandrels (2), Mandrel Adapter (1), in Heavy Duty Case.	9592	E0103113
9 Pc. Electrician's Kit Kit Includes: 6 Hole Saws: 7/8"(22mm), 1-1/8"(29mm), 1-3/8"(35mm), 1-3/4"(44mm), 2"(51mm), 2-1/2"(64mm); Mandrels (2), Mandrel Adapter (1), in Heavy Duty Case.	9593	E0103114
9 Pc. Electrician's Kit - Metric Kit Includes: 6 Hole Saws: 16mm (5/8"), 20mm, 25mm (1"), 32mm (1-1/4"), 40mm (1-9/16"), 51mm (2"); Mandrels (2), Mandrel Adapter (1), in Heavy Duty Case.	9593M	E0103115
13 Pc. Journeyman's Kit Kit Includes: 9 Hole Saws: 3/4"(19mm), 7/8"(22mm), 1-1/8"(29mm), 1-3/8"(35mm), 1-1/2"(38mm), 1-3/4"(44mm), 2"(51mm), 2-1/4"(57mm), 2-1/2"(64mm); Mandrels (2), Mandrel Adapter (1), Pilot Drill (1), in Heavy Duty Case.	9596	E0103116
20 Pc. Industrial Kit Kit Includes: 15 Hole Saws: 3/4"(19mm), 7/8"(22mm), 1-1/8"(29mm), 1-3/8"(35mm), 1-1/2"(38mm), 1-3/4"(44mm), 2"(51mm), 2-1/4"(57mm), 2-1/2"(64mm), 3"(76mm), 3-1/4"(83mm), 3-5/8"(92mm), 3-3/4"(95mm), 4-1/8"(105mm), 4-1/2"(114mm), Mandrels (2), Mandrel Adapter (1), Pilot Drill (1), 12" Extension (1), in Heavy Duty Steel Case.	9599	E0103117



BLU-MOL® SHEET METAL HOLE SAWS

Ideal for the electrical and plumbing tradesman, construction, aircraft, maintenance and automotive applications. Hole saw has a thin 0.02" (0.5 mm) sidewall blade thickness, allowing for faster cutting and longer battery life. Ideal for chargeable impact drivers. Use in thin applications of mild steel, brass, aluminum, stainless steel or plastic.



HOLE SAWS



Boxed

DIAMETER		MODEL #	PRODUCT CODE
INCHES	MM		
5/8"	16	6918	E0102325
3/4"	19	6919	E0102326
--	20	6920	E0102327
7/8"	22	6921	E0102328
1"	25	6922	E0102329
1-1/16"	27	6923	E0102330
1-1/8"	29	6924	E0102331
1-3/16"	30	6925	E0102332
1-1/4"	32	6926	E0102333
1-3/8"	35	6927	E0102334
1-1/2"	38	6928	E0102335



SMOOTH AND FAST CUTTING

Specially designed tooth geometry assures increased performance and better wear resistance.



THE POWER OF THE THIN BLADE

Lightweight blades maximize the use of chargeable impact drivers by using a reduced motor and operation load.



SAFETY COLLAR STOP

Safety collar stop helps prevent cutting too deep.



SAFETY COLLAR STOP

Safety collar stop helps prevent damage to wires when drilling into electrical boxes.



TRI-CUT TUNGSTEN CARBIDE TIPPED HOLE CUTTERS



Tungsten carbide tips with three distinct cutting edges balances the cutting for longer blade life and heat resistance. For cutting thick steel, iron, aluminum, steel plate, pipe and stainless steel up to 1" (25mm) thick.

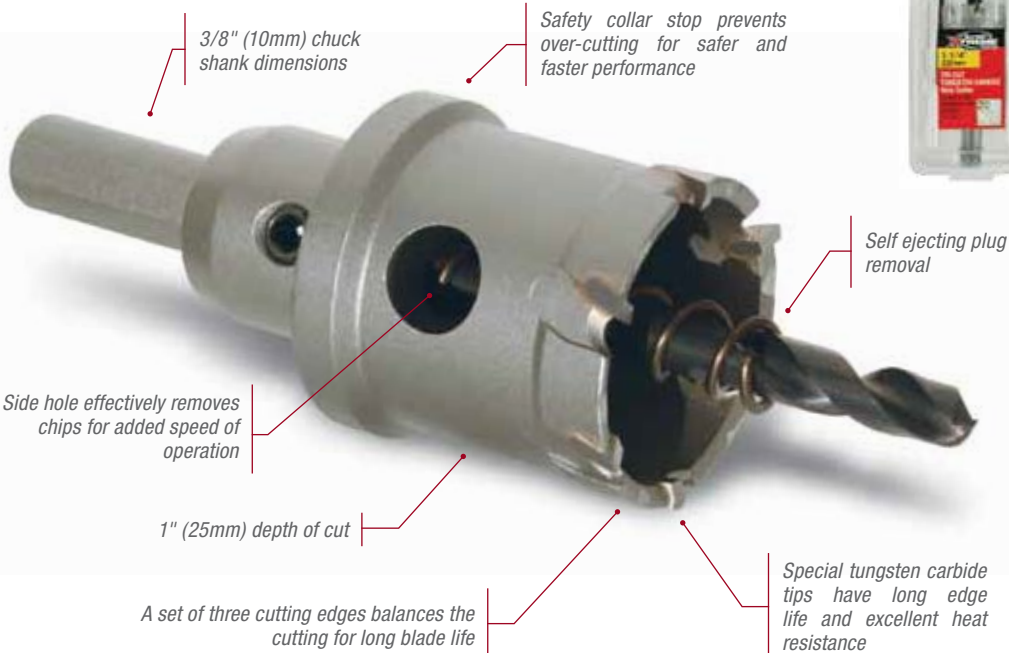

Clamshelled

DIAMETER		MODEL #	PRODUCT CODE
INCHES	MM		
5/8"	16	3140	E0102336
11/16"	17	3141	E0102337
3/4"	19	3142	E0102338
--	20	3205	E0102554
13/16"	21	3143	E0102339
7/8"	22	3144	E0102340
15/16"	24	3145	E0102341
1"	25	3146	E0102342
1-1/16"	27	3147	E0102343
1-1/8"	29	3148	E0102344
1-3/16"	30	3149	E0102345
1-1/4"	32	3150	E0102346
1-5/16"	33	3151	E0102347
1-3/8"	35	3152	E0102348
1-7/16"	37	3153	E0102349
1-1/2"	38	3154	E0102350
1-9/16"	40	3155	E0102351
1-5/8"	41	3156	E0102352
1-11/16"	43	3157	E0102353
1-3/4"	44	3158	E0102354
1-13/16"	46	3159	E0102355
1-7/8"	48	3160	E0102356
1-15/16"	49	3161	E0102357
2"	51	3162	E0102358

Accessories (Carded)

KIT DESCRIPTION	MODEL #	PRODUCT CODE
Pilot Drill, Spring & Set Screw for Tri-Cut TCT Cutter	3163	E0102323

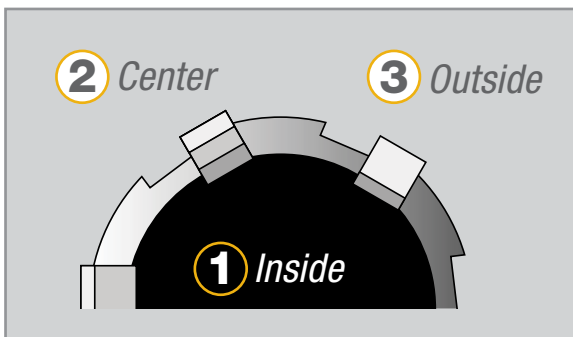

TRI-CUT SYSTEM

There are three different edged cutting blades. One blade slanted outward, one inward and one that peaks in the center. This arrangement balances the cutting effort for smooth boring, better control and less chance of excess drag.

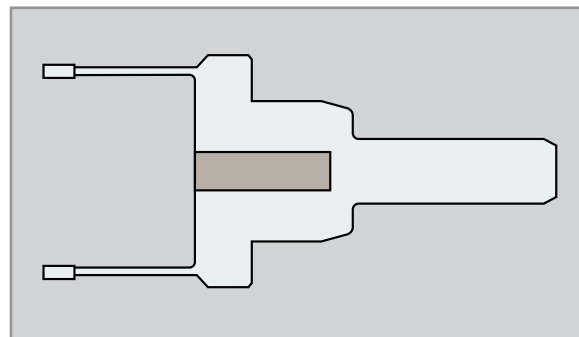

UNI-BODY CONSTRUCTION

The arbored hole cutter has solid construction that eliminates play between the shank and the body, resulting in sharp, crisp, smooth cutting.

HOLE SAWS

BLU-MOL® STANDARD TUNGSTEN CARBIDE TIPPED HOLE CUTTERS



Tungsten carbide tips have excellent wear and heat resistance. Light, smooth cutting entry with great boring speed. For cutting stainless steel, steel, aluminum and cast iron up to 3/16" (4,5mm) thick.

HOLE SAWS

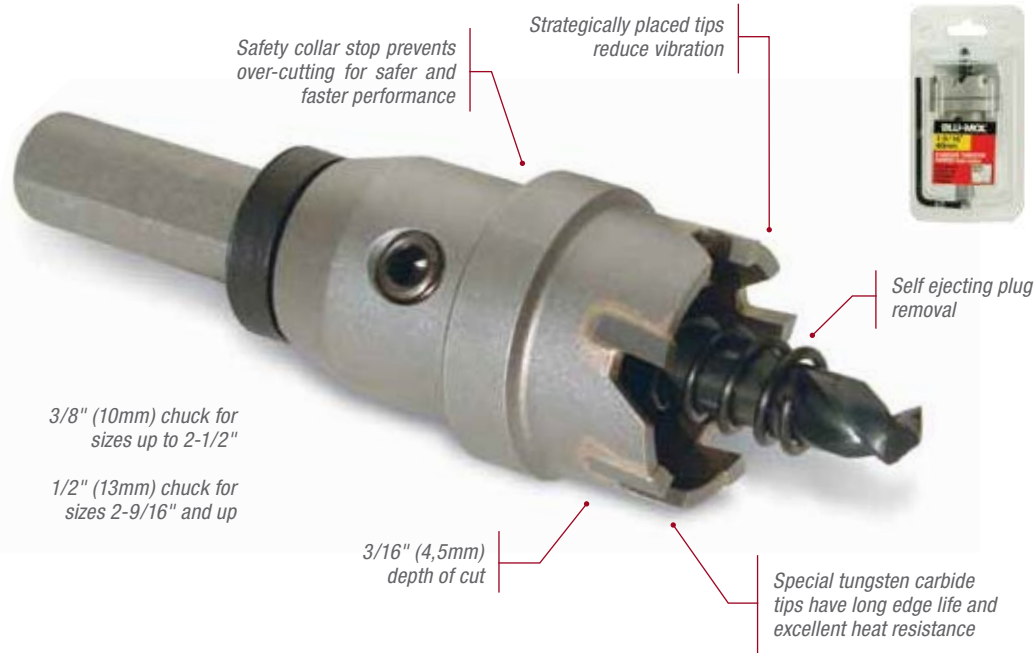

Clamshelled

DIAMETER		MODEL #	PRODUCT CODE
INCHES	MM		
9/16"	14	3164	E0102359
5/8"	16	3165	E0102360
11/16"	17	3166	E0102361
3/4"	19	3167	E0102362
--	20	3206	E0102555
13/16"	21	3168	E0102363
7/8"	22	3169	E0102364
15/16"	24	3170	E0102365
1"	25	3171	E0102366
1-1/16"	27	3172	E0102367
1-1/8"	29	3173	E0102368
1-3/16"	30	3174	E0102369
1-1/4"	32	3175	E0102370
1-5/16"	33	3176	E0102371
1-3/8"	35	3177	E0102372
1-7/16"	37	3178	E0102373
1-1/2"	38	3179	E0102374
1-9/16"	40	3180	E0102375
1-5/8"	41	3181	E0102376
1-11/16"	43	3182	E0102377
1-3/4"	44	3183	E0102378
1-13/16"	46	3184	E0102379
1-7/8"	48	3185	E0102380
1-15/16"	49	3186	E0102381
2"	51	3187	E0102382
2-1/16"	52	3188	E0102383
2-1/8"	54	3189	E0102384
2-3/16"	56	3190	E0102385
2-1/4"	57	3191	E0102386
2-5/16"	59	3192	E0102387
2-3/8"	60	3193	E0102388
2-7/16"	62	3194	E0102389
2-1/2"	64	3195	E0102390
2-9/16"	65	3196	E0102391
2-5/8"	67	3197	E0102392
2-11/16"	68	3198	E0102393
2-3/4"	70	3199	E0102394
2-7/8"	73	3201	E0102396
3"	76	3203	E0102398

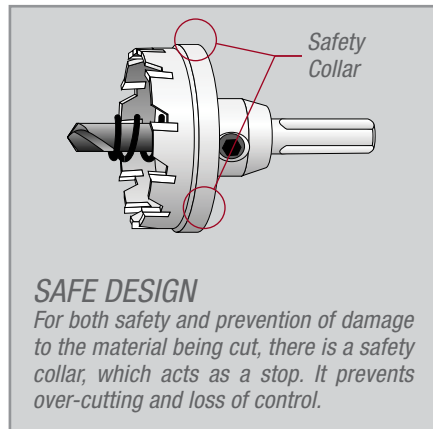
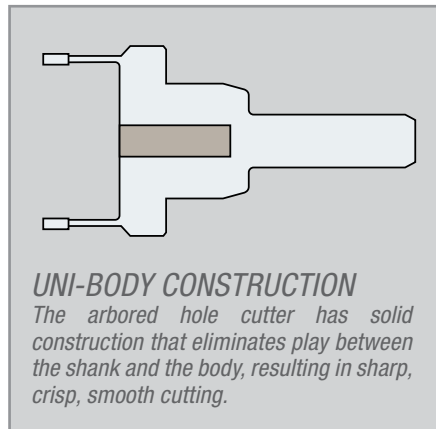
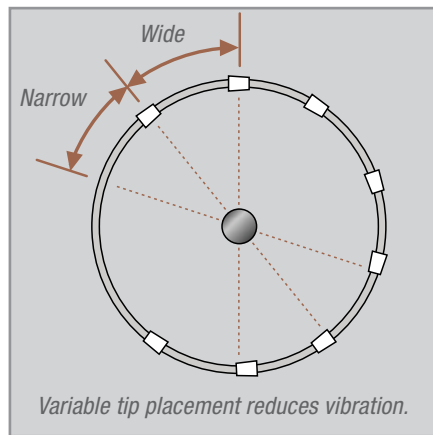
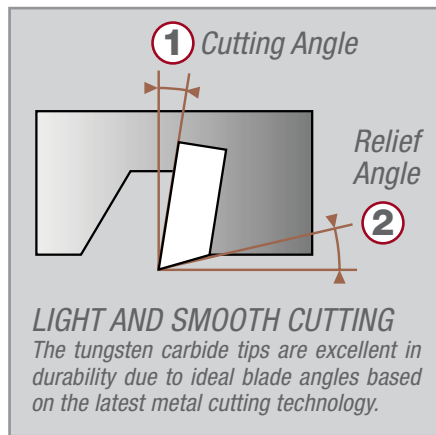

Accessories (Carded)

KIT DESCRIPTION	MODEL #	PRODUCT CODE
Pilot Drill, Spring & Set Screw for Std. TCT Cutter	3204	E0102324



CARBIDE TIPPED HOLE SAWS



Carbide tip allows for greater heat and wear resistance than bi-metal. Provides up to 10 times greater tool life on abrasive materials. Ideal for plumbing, marine and aircraft applications. Use in wood laminates, fiberglass, plywood and tile.



Wear-resistant tungsten carbide for long life cutting through abrasive materials

1-1/2" (38 mm) depth of cut

Unique tooth geometry designed for aggressive cutting (3 teeth per inch)



Boxed

DIAMETER		MODEL #	PRODUCT CODE
INCHES	MM		
11/16	17	C11	E0103118
3/4	19	C12	E0103119
7/8	22	C14	E0103120
1	25	C16	E0103121
1-1/8	29	C18	E0103122
1-1/4	32	C20	E0103123
1-3/8	35	C22	E0103124
1-1/2	38	C24	E0103125
1-5/8	41	C26	E0103126
1-3/4	44	C28	E0103127
2	51	C32	E0103128
2-1/8	54	C34	E0103129
2-1/4	57	C36	E0103130
2-3/8	60	C38	E0103131
2-1/2	64	C40	E0103132
2-9/16	65	C41	E0103133
2-5/8	67	C42	E0103134
3	76	C48	E0103135
3-1/4	83	C52	E0103136
3-3/8	86	C54	E0103137
3-1/2	89	C56	E0103138
3-5/8	92	C58	E0103139
3-3/4	95	C60	E0103140
4	102	C64	E0103141
4-1/8	105	C66	E0103142
4-1/4	108	C68	E0103143
4-1/2	114	C72	E0103144
4-3/4	121	C76	E0103145
5	127	C80	E0103146
5-1/2	140	C88	E0103147
6	152	C96	E0103148

HOLE SAWS

Blu-Mol Xtreme® Carbide Tipped Hole Saw Kit

KIT DESCRIPTION	MODEL #	PRODUCT CODE
13 Pc Carbide Tipped Hole Saw Kit Includes: 1 each 3/4"(19mm), 7/8"(22mm), 1-1/8"(29mm), 1-3/8"(35mm), 1-1/2"(38mm), 1-3/4"(44mm), 2"(51mm), 2-1/4"(57mm) & 2-1/2"(64mm) hole saws; 2 mandrels; mandrel adapter and carbide tipped pilot drill bits in a plastic case	C9596	E0212384

BLU-MOL® CARBON STEEL HOLE SAWS

Specifically developed for the occasional user. Patented arbored design is packaged in clamshells. Hole saws and accessories also available in convenient sets. Ideal for home, general maintenance and light duty applications. Use in wood, wallboard, and plastic.



HOLE SAWS

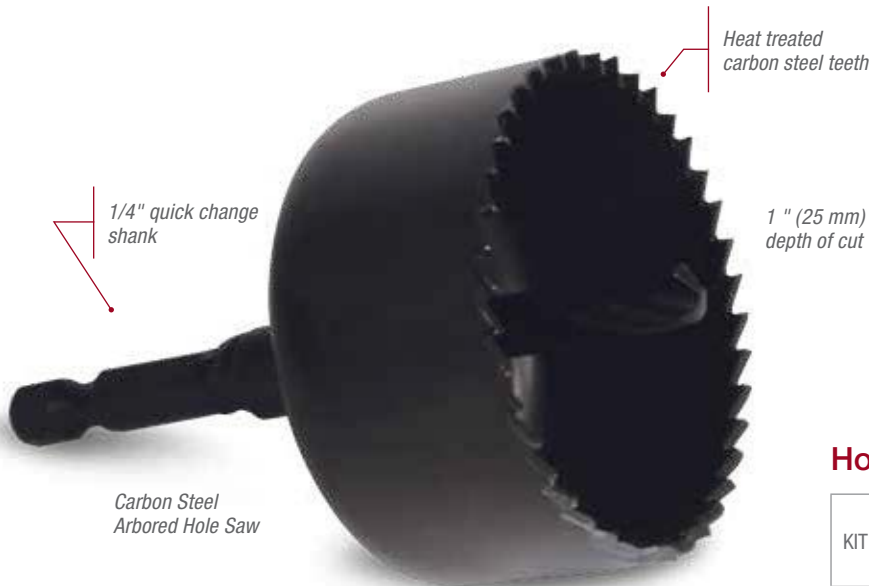

Carbon Steel Arbored Hole Saw

Arbored Hole Saws (Clamshelled)

DIAMETER		MODEL #	MIN. ORDER QTY.	PRODUCT CODE
INCHES	MM			
1	25	6501	5	E0114453
1-1/4	32	6502	5	E0114454
1-1/2	38	6503	5	E0114455
1-3/4	44	6504	5	E0114456
2	51	6506	5	E0114457
2-1/8	54	6507	5	E0114458
2-1/4	57	6508	5	E0114459
2-1/2	64	6509	5	E0114460

Hole Saw Kits

KIT DESCRIPTION	MODEL #	MIN. ORDER QTY.	PRODUCT CODE
5 Pc Carbon Hole Saw Kit Includes: 1 each 1-1/4"(32mm), 1-1/2"(38mm), 1-3/4"(44mm) & 2-1/8"(54mm) holes saws; mandrel w/pilot drill in a plastic storage tube	6560	5	E0114489
7 Pc Carbon Hole Saw Kit Includes: 1 each 1-1/4"(32mm), 1-3/8"(35mm), 1-1/2"(38mm), 1-3/4"(44mm), 2"(51mm) & 2-1/8"(54mm) hole saws; mandrel w/pilot drill in a plastic case	6561	5	E0114490



Model #6560



Model #6561

RemGrit CARBIDE GRIT RECESSED LIGHT INSTALLATION KITS



Complete kits for any recessed light installation job. The carbide grit cutting edge easily cuts through ceiling tile and drywall. Recessed light kits are available for 4", 5" and 6" lighting fixtures.

Features a continuous grit edge



Mandrel & Pilot bit included

Recessed Light Installation Hole Saws

DIAMETER		MODEL #	PRODUCT CODE
INCHES	MM		
4-3/8	111	GRL402	E0101680
5-3/8	137	GRL502	E0101681
6-3/8	162	GRL602	E0101682





RemGrit CARBIDE GRIT HOLE SAWS



Cuts extremely hard abrasive materials: Laminates, fiberglass, ceramic tile, marble, slate, cast iron and composites. Cutting edge of tungsten carbide particles bonded to alloy steel back. High heat and abrasion resistance, no teeth to dull or chip, resists snagging, smooth cutting, greater wear resistance. Ideal for plumbing, construction, marine and aircraft applications.

3/16" (5 mm) thick heavy-duty backing plate eliminates drive hole elongation and the need for drive plate

1-7/16" (37 mm) depth of cut

RemGrit hole saws (without arbors) feature a gulletted grit edge



Boxed

DIAMETER		MODEL #	PRODUCT CODE
INCHES	MM		
5/8	16	G010M	E0206026
3/4	19	G012	E0206001
--	20	G013M	E0206027
7/8	22	G014	E0206002
1	25	G016	E0206003
1-1/8	29	G018	E0206004
1-1/4	32	G020	E0206005
1-3/8	35	G022	E0206006
1-1/2	38	G024	E0206007
1-3/4	44	G028	E0206008
1-7/8	48	G030	E0206023
2	51	G032	E0206009
2-1/8	54	G034	E0206010
2-1/4	57	G036	E0206011
2-3/8	60	G038	E0206024
2-1/2	64	G040	E0206022
2-3/4	70	G044	E0206013
3	76	G048	E0206014
3-1/4	83	G052	E0206015
3-3/8	86	G054	E0206016
3-3/4	95	G060	E0206025
4	102	G064	E0206017
4-1/2	114	G072	E0206018

HOLE SAWS

RemGrit arbored hole saws feature a continuous grit edge

1/4" quick change shank

7/8" (22 mm) depth of cut



Arbored Hole Saws (Clamshelled)

DIAMETER		MODEL#	MIN. ORDER QTY.	PRODUCT CODE
INCHES	MM			
1	25	OGC16BL	2	E0104577
1-1/4	32	OGC20BL	2	E0104578
1-1/2	38	OGC24BL	2	E0104579
1-3/4	44	OGC28BL	2	E0104580
2	51	OGC32BL	2	E0104581
2-1/8	54	OGC34BL	2	E0104582
2-1/4	57	OGC36BL	2	E0104583
2-1/2	64	OGC40BL	2	E0104584

BLU-MOL® & RemGrit® HOLE SAW ACCESSORIES

Accessories for use with our Blumol®, Blumol Xtreme® or Remgrit® Hole Saws.

HOLE SAWS



Mandrels for Bi-Metal, Carbide Tip and RemGrit® Hole Saws

MODEL #	PRODUCT CODE	BRAND	FITS HOLE SAWS	SHANK	DESCRIPTION
5514	E0102457	Blu-Mol®	Bi-Metal Hole Saws in diameter 9/16" - 1-3/16"	3/8"	Hex Shank Mandrel. Includes 3-1/4" x 1/4" pilot drill. Packed 1/box.
5519	E0102458	Blu-Mol®	Bi-Metal Hole Saws in diameter 1-1/4" - 4"	3/8"	Hex Shank Mandrel. Includes 3-1/4" x 1/4" pilot drill. Packed 1/box.
5545	E0102459	Blu-Mol®	Bi-Metal Hole Saws in diameter 1-1/4" - 6"	7/16"	Hex Shank, Pin Drive Mandrel. Includes 3-1/4" x 1/4" pilot drill. Packed 1/box.
5546	E0102460	Blu-Mol®	Bi-Metal Hole Saws in diameter 1-1/4" - 6"	3/8"	Hex Shank, Pin Drive Mandrel. Includes 3-1/4" x 1/4" pilot drill. Packed 1/box.
5547	E0102465	Xtreme®	--	1/4"	Hole Enlarger. Allows a smaller hole saw to become the pilot to enlarge an existing hole. Packed 1/card.
5519RG	E0102841	RemGrit®	RemGrit and Carbide Tip Hole Saws in diameter 1-1/4" - 6"	3/8"	Hex Shank Mandrel. Includes Carbide Tip pilot drill. Packed 1/box.
5546RG	E0102855	RemGrit®	RemGrit and Carbide Tip Hole Saws in diameter 1-1/4" - 6"	3/8"	Hex Shank Mandrel. Includes 3-1/4" x 1/4" pilot drill. Packed 1/box.



12" Extensions
7/16" 5500 & 3/8" 6558

5511

SS1

DB1

Accessories for Bi-Metal, Carbide Tip and RemGrit® Hole Saws

MODEL #	PRODUCT CODE	BRAND	FITS HOLE SAWS	SHANK	DESCRIPTION
5500	E0102461	Blu-Mol®	7/16" x 12" Extension	7/16"	12" extension. Used to assist drilling holes in hard-to-reach places. Packed 1/box.
6558	E0101668	Blu-Mol®	3/8" x 12" Extension	3/8"	12" extension. Used to assist drilling holes in hard-to-reach places. Packed 1/box.
SS1	E0103109	Generic	For use with mandrels: 5514, 5519, 5546, 519RG & 5546RG	--	Mandrel Set Screws. Includes 6 screws (2 each of 3 sizes) to fit into any of our mandrels. Packed 6/envelope.
DB1	E0215000	Blu-Mol®	For use with any Blu-Mol®, Xtreme® or RemGrit® mandrel	--	Dust bowl. Bowl collects dust and debris while driving overhead. Packed individually.
5511	E0102462	Blu-Mol®	For use with mandrels: 5514, 5519 & 5519RG	--	Mandrel Adapter. Adapter allows our smaller mandrels to be used with larger diameter hole saws. Packed 1/card.

Pilot Drills for Bi-Metal, Carbide Tip and RemGrit Hole Saws

MODEL #	PRODUCT CODE	BRAND	FITS HOLE SAWS	DESCRIPTION
8534	E0102463	Blu-Mol®	Bi-Metal hole saws	Pilot Drill. 3-1/4" x 1/4" High Speed Steel. Packed 10/box.
6524	E0114470	Blu-Mol®	Bi-Metal hole saws	Pilot Drill. 3-1/4" x 1/4" High Speed Steel. Packed 1/card.
8535	E0215261	Generic	Bi-Metal hole saws	Pilot Drill. 4-1/4 x 1/4" High Speed Steel. Packed 10/box.
8538RG	E0103107	RemGrit®	RemGrit® and Carbide Tip hole saws	Pilot Drill. 3-1/4" x 1/4" Carbide Tip. Packed 1/card.

BLU-MOL® & **X**TRIME™ "DISSTON"

LOCK INSTALLATION KITS



Model # 6575

TYPE/SIZE	MODEL #	MIN. ORDER QTY.	PRODUCT CODE
Blu-Mol® Professional Bi-Metal Lock Installation Kit Includes: 1 each 1" & 2-1/8" hole saws, guide, assembled mandrel and mandrel adapter	6574	5	E0101949
Blu-Mol® Door Latch Mortise Tool	6575	5	E0101959
Blu-Mol Xtreme® Bi-Metal Lock Installation Kit Includes: 1 each 1" & 2-1/8" hole saws, assembled mandrel and mandrel adapter	6556	6	E0114493



Model # 6556



Model # 6574

HOLE SAWS

RECIPROCATING SAW INDEX

Disston's superior collection of reciprocating saw blades make quick work of anything you can throw at it. Reciprocating saw blades are available in individual packages, handy multi-pack tubes and bulk.



RECIPROCATING SAW BLADES



Blu-Mol Xtreme® Demolition Bi-Metal

Incredibly tough demolition reciprocating saw blades. These tough blades are made wider and thicker than normal reciprocating saw blades for heavy-duty applications such as demolition and rescue projects.



Blu-Mol® Bi-Metal

These Bi-Metal reciprocating saw blades are designed for efficient cutting in a wide variety of materials including wood, metal and plastic. These blades make quick and accurate cuts for general purpose projects.



Blu-Mol Xtreme® Pallet

M42 cutting edge with 8% cobalt yields longer life for high performance cutting in dismantling pallets.



RemGrit® Carbide Grit

Carbide particles bonded to a steel blade. This blade cuts extremely abrasive materials. Carbide grit offers the greatest wear and heat resistance. Ideal for materials that other blades will not cut.



BI-METAL DEMOLITION RECIPROCATING SAW BLADES



These Xtreme® saw blades are wider and thicker and have been engineered for heavy-duty applications. Designed for tough, heavy duty cutting jobs and are built to last.



6 TPI Wood

- For cutting nail embedded wood, railroad ties and other tough materials.
- Wider (7/8") and thicker (.062) blades for demolition work.
- Available in 6", 9" and 12" lengths with 1/2" universal shanks.



Wood Cutting

SIZE		TEETH PER INCH	BULK (20/PK)		10/TUBE	
LENGTH INCHES	MM		MODEL #	PRODUCT CODE	MODEL #	PRODUCT CODE
6 x 7/8 x .062	150 x 22 x 1,60	6	6486	E0101329	6486-10T	E0102829
9 x 7/8 x .062	225 x 22 x 1,60	6	6487	E0101330	6487-10T	E0102831
12 x 7/8 x .062	305 x 22 x 1,60	6	6488	E0101331	6488-10T	E0102833



14 TPI Metal

- For cutting pipe, angle iron, nail embedded wood and structural steel.
- Wider (1") and thicker (.042) blades for demolition work.
- Available in 6", 9" and 12" lengths with 1/2" universal shanks.



Metal Cutting

SIZE		TEETH PER INCH	BULK (20/PK)		10/TUBE	
LENGTH INCHES	MM		MODEL #	PRODUCT CODE	MODEL #	PRODUCT CODE
6 x 1 x .042	150 x 22 x 1,60	14	6489	E0101332	6489-10T	E0102830
9 x 1 x .042	225 x 22 x 1,60	14	6490	E0101333	6490-10T	E0102832
12 x 1 x .042	305 x 22 x 1,60	14	6491	E0101334	6491-10T	E0102834

Saw Blade Assortment

PRODUCT CODE	DEMOLITION RECIP BLADE ASSORTMENTS
E0320095	Contains: 20 each of 6"x 6T, 9"x 6T, & 12"x 6T, Wood Cutting blades, 20 each of 6"x 14T, 9"x 14T, & 12"x 14T Metal Cutting blades, Rack & Header
E0320096	Contains: 5 each of 6"x 6T, 9"x 6T, & 12"x 6T, Wood Cutting blades, 5 each of 6"x 14T, 9"x 14T, & 12"x 14T Metal Cutting blades, Rack & Header



E0320095 or E0320096
7-1/2" W x 18-1/2"H

RECIPROCATING SAW BLADES

BLU-MOL® BI-METAL RECIPROCATING SAW BLADES



Reciprocating saw blades are designed for efficient cutting in a wide variety of materials including wood, metal and plastic. All have the 1/2" universal shank that fits all standard 1/2" shank reciprocating saws. Made for quick and accurate cutting.

SIZE			1/CARD		5/TUBE		10/TUBE		BULK (50/PK)	
LENGTH INCHES	MM	TEETH PER INCH	MODEL #	PRODUCT CODE	MODEL #	PRODUCT CODE	MODEL #	PRODUCT CODE	MODEL #	PRODUCT CODE
Wood Cutting										
6 x 3/4 x .050	150 x 20 x 1,30	5/7	6469	E0114441	6481-5T	E0104525	6481	E0114450	6481-50	E0102258
6 x 3/4 x .050	150 x 20 x 1,30	6	6446	E0102237	6480-5T	E0102813	6480	E0114449	6480-50	E0102214
6 x 3/4 x .050	150 x 20 x 1,30	10	6462	E0114437	6478-5T	E0102817	6478	E0114447	6478-50	E0102218
9 x 3/4 x .050	225 x 20 x 1,30	6	6447	E0102238	6482-5T	E0104526	6482	E0114451	6482-50	E0102252
12 x 3/4 x .050	300 x 20 x 1,30	6	6448	E0102239	6483-5T	E0104527	6483	E0114452	6483-50	E0102253
Metal Cutting										
3 x 5/16 x .035 scroll	90 x 8 x 0,90	14	6461	E0114436	6955-5T	E0102812	6955	E0102248	6955-50	E0102254
6 x 3/4 x .035	150 x 20 x 0,90	14	6455	E0114430	6475-5T	E0102819	6475	E0114444	6475-50	E0102820
6 x 3/4 x .035	150 x 20 x 0,90	18	6445	E0102236	6476-5T	E0102821	6476	E0114445	6476-50	E0102822
6 x 3/4 x .035	150 x 20 x 0,90	24	6457	E0114432	6477-5T	E0102823	6477	E0114446	6477-50	E0102824
8 x 3/4 x .035	200 x 20 x 0,90	18	6449	E0104498	6961-5T	E0102240	6961	E0102241	6961-50	E0100033
9 x 3/4 x .035	225 x 20 x 0,90	14	6466	E0104499	6958-5T	E0104528	6958	E0102827	6958-50	E0102255
12 x 3/4 x .035	300 x 20 x 0,90	18	6473	E0104500	6474-5T	E0104966	6474	E0104967	6474-50	E0104968
All-Purpose Cutting										
8 x 3/4 x .035	200 x 20 x 0,90	10/14	6463	E0114438	6479-5T	E0102825	6479	E0114448	6479-50	E0102826
12 x 3/4 x .050	300 x 20 x 1,30	10/14	6498	E0104502	6959-5T	E0104529	6959	E0102828	6959-50	E0102256
12 x 3/4 x .050 taper	300 x 20 x 1,30	10/14	6499	E0104503	6960-5T	E0103198	6960	E0103199	6960-50	E0100034
Plaster Cutting										
6 x 3/4 x .050	150 x 20 x 0,90	6	6467	E0114439	6956-5T	E0102815	6956	E0102249	6956-50	E0102257

RECIPROCATING SAW BLADES



E0320099 or E0320100
15" W x 18-1/4" H

Blu-Mol® Saw Blade Assortment

PRODUCT CODE	RECIP BLADE ASSORTMENTS
E0320099	Contains: 10/tube of 6" X 6T & 9" X 6T Xtreme Wood Cutting, 10/tube of 6" X 14T & 9" X 14T Xtreme Metal Cutting, 5/tube of 6" X 6T, 9" X 6T, & 6" X 10T Standard Wood Cutting, 5/tube of 6" X 14T, 6" X 18T, & 6" X 24T Standard Metal Cutting, 5/tube of 8" X 10/14T & 12" X 10/14T Standard All-Purpose Cutting, Rack & Header
E0320100	Contains: 10/tube of 6" X 6T & 9" X 6T Xtreme Wood Cutting, 10/tube of 6" X 14T & 9" X 14T Xtreme Metal Cutting, 10/tube of 6" X 6T, 9" X 6T, & 6" X 10T Standard Wood Cutting, 10/tube of 6" X 14T, 6" X 18T, & 6" X 24T Standard Metal Cutting, 10/tube of 8" X 10/14T & 12" X 10/14T Standard All-Purpose Cutting, Rack & Header



PALLET RECIPROCATING SAW BLADES



- High performance cutting for pallet dismantling
- M42 cutting edge with 8% cobalt for longer life
- Special heat treat for increased tooth life
- Unique tooth design for fast cutting
- Rounded nose for easy cutting and safer operation
- Special blade backer for greater flexibility when cutting block pallets

Blu-Mol Xtreme® Pallet Saw

SIZE			BULK (250/PK)	
LENGTH		TEETH PER INCH	MODEL #	PRODUCT CODE
INCHES	MM			
8 x 3/4 x .035	203 x 19 x .9 25	10	6988	E0102533

RECIPROCATING SAW BLADES



CARBIDE GRIT RECIPROCATING SAW BLADES



Cuts extremely hard abrasive materials. The cutting edge of tungsten carbide particles is permanently bonded to an alloy steel back. These blades have high heat and abrasion resistance. There are no teeth to dull or chip and the blades cut on both strikes. Resists snagging and are always smooth cutters.



RemGrit® Reciprocating Saw Blades

SIZE			1/CARD		10/TUBE		BULK (50/PK)	
LENGTH		GRIT	MODEL #	PRODUCT CODE	MODEL #	PRODUCT CODE	MODEL #	PRODUCT CODE
INCHES	MM							
6 x 3/4 x .032	150 x 20 x 0,90	Coarse	GR24BL	E0406122	GR24-10T	E0102835	GR24-50	E0206112
8 x 3/4 x .042	200 x 20 x 0,90	Coarse	GR26BL	E0406123	GR26-10T	E0102251	GR26-50	E0206113

JIG SAW BLADE INDEX

Disston jig saw blades are available in bi-metal, carbon, high-speed steel and grit-edge for cutting in a wide variety of materials.

NEW Fit-All™ Jig Saw Blades

- Fit-All™ shank takes the place of the U-shank and T-shank
- For cutting in wood, plastic, metal, ceramic and tile
- Blades offered in High Carbon Steel, High Speed Steel, Bi-Metal and Tungsten Carbide
- Precision ground teeth for better life and performance

U Shank + T Shank =
FIT-ALL™ SHANK

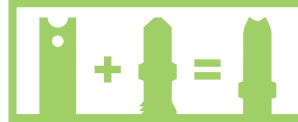

Fit-All
Shank



Bi-Metal

Bi-metal jig saw blades are made with cobalt for heavy duty cutting in wood and metal. These bi-metal jig saw blades are very durable and long lasting.

Fit-All
Shank



Carbon

High carbon steel jig saw blades are designed for general purpose cutting in wood. Made for quick and accurate cutting.

Fit-All
Shank



High Speed Steel

High speed steel for cutting in metal.

Universal
Shank



T-Shank



Carbide Grit

Carbide particles bonded to a steel blade. This saw cuts extremely abrasive materials with no teeth to chip or dull. Carbide grit offers the greatest wear and heat resistance. Ideal for materials that other blades will not cut.



BI-METAL JIG SAW BLADES



Bi-metal jig saw blades are for cutting metals, steel and stainless steel. Their high strength steel cutting edges are hardened and offer the flexibility required for durable, longer lasting blades. Made for heavy duty cutting in wood and metal.

NEW FIT-AL™ SHANK

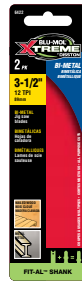
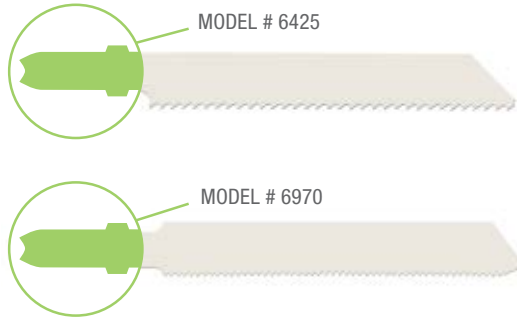

TEETH PER INCH	SIZE		APPLICATION		2/CARD		25/TUBE	
	LENGTH INCHES	MM	TYPE OF CUT	MATERIAL	MODEL #	PRODUCT CODE	MODEL #	PRODUCT CODE
6	3-1/2	89	Rough	Wood & Metal	6420	E0114415	6420-25T	E0102839
10/14	3-1/2	89	All Purpose	Wood & Metal	6421	E0114416	--	--
12	3-1/2	89	All Purpose	Wood & Metal	6422	E0114417	6422-25T	E0102840
14	3	76	Rough	Metal	6425	E0101950	--	--
18	3	76	All Purpose	Metal	6423	E0114418	--	--
24	3	76	Smooth	Metal	6424	E0114419	--	--
32	3	76	Smooth	Metal	6970	E0102843	6970-25T	E0102844
Grit	2-7/8	73	Smooth	Tile, Cast Iron & Fiberglass	6464	E0102317	--	--

JIG SAW BLADES



CARBON & HIGH SPEED STEEL JIG SAW BLADES



Carbon jig saw blades are used for cutting wood. These carbon jig saw blades provide a very clean and fast cut for most for general purpose cutting. High Speed Steel is used for cutting in metal.

NEW FIT-AL™ SHANK



TEETH PER INCH	SIZE		APPLICATION		2/CARD		BLADE TYPE
	LENGTH INCHES	MM	TYPE OF CUT	MATERIAL	MODEL #	PRODUCT CODE	
Carbon							
6	3-1/8	79	Rough	Wood	6412	E0114410	Carbon
6	3-1/2	89	Rough	Wood	6401	E0114400	Carbon
6	6	152	Rough	Wood	6434	E0102319	Carbon
8	2-3/4 - Flush	70	Flush	Wood	6453	E0102227	Carbon
8	3-5/8	92	All Purpose	Plaster	6419	E0102228	Carbon
8	4-1/8	105	Rough	Wood	6428	E0102229	Carbon
10	2-3/4	70	All Purpose	Wood	6417	E0102232	Carbon
10	2-3/4 - Scroll	70	Rough	Wood	6441	E0102225	Carbon
10	3-1/8	79	Smooth	Formica	6408	E0114406	Carbon
10	3-1/8	79	Smooth	Wood	6418	E0102233	Carbon
10	3-1/8 - Scroll	79	Smooth	Wood	6411	E0114409	Carbon
10	3-1/2	89	All Purpose	Wood	6407	E0114405	Carbon
12	3-1/8 - Reverse Tooth	79	Smooth	Wood	6465	E0102321	Carbon
14	2-3/4 - Scroll	70	Smooth	Wood	6406	E0114404	Carbon
19	2-3/4 - Scroll	70	Smooth	Wood	6444	E0102226	Carbon
High Speed Steel							
12	2-3/4	70	All Purpose	Metal	6413	E0114411	HSS
21	2-3/4	70	Smooth	Metal	6415	E0114413	HSS
24	3-1/8	79	Smooth	Metal	6454	E0102318	HSS
32	2-3/4	70	Smooth	Metal	6416	E0114414	HSS

BLU-MOL[®] JIG SAW BLADE SETS

Blu-Mol Jig Saw blade assorted sets give you the right blades for any project you might have. Each set has been expertly matched to cut traditional wood, plastic or metal materials, from thin to thick, rough to smooth cut.



NEW FIT-AL™ SHANK

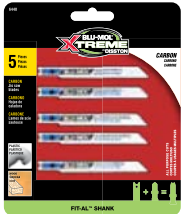

Model # 6440



Model # 6437

Bi-Metal Jig Saw Sets

SET INCLUDES	TYPE OF CUT	MATERIAL	MODEL #	PRODUCT CODE
3Pc Bi-Metal Blades: (1) 3" x 14T, (1) 3" x 18T, (1) 3" x 24T	All Purpose	Metal	6426	E0102234
5Pc Carbon Blades: (1) 3-1/2" x 6T, (2) 3-1/2" x 10T, (2) 2-3/4" x 14T scroll	All Purpose	Wood	6440	E0101729
5Pc Bi-Metal Blades: (2) 3" x 14T, (2) 3" x 18T, (1) 3" x 24T	All Purpose	Metal	6443	E0101958
7Pc Bi-Metal Blades: (2) 3-1/2" x 6T, (2) 3-1/2" x 10/14T, (1) 3" x 14T, (1) 3" x 18T, (1) 3" x 24T	All Purpose	Wood & Metal	6427	E0102235
10Pc Carbon Blades: (2) 3-1/2" x 6T, (2) 3-1/2" x 10T, (1) 3-1/8" x 10T, 2-3/4" x 10T, (1) 2-3/4" x 14T scroll HSS Blades: (1) 2-3/4" x 12T, (1) 2-3/4" x 18T, (1) 2-3/4" x 21T	All Purpose	Wood & Metal	6433	E0102231
12Pc Carbon Blades: (2) 3-1/2" x 6T, (2) 3-1/2" x 10T, (2) 2-3/4" x 14T scroll, Bi-Metal Blades: (1) 3-1/2" x 10/14T, (2) 3" x 14T, (2) 3" x 18T, (1) 3" x 24T	All-Purpose	Wood & Metal	6442	E0101730
25Pc Carbon Blades (5) 3-1/2" x 6T, (5) 3-1/2" x 10T, (5) 2-3/4" x 14T-scroll, Bi-metal Blades: (5) 3-1/2" x 10/14T, (5) 3" x 18T	All Purpose	Wood & Metal	6437	E0114425

RemGrit[®] CARBIDE GRIT JIG SAW BLADES

Carbide grit jig saw blades cut extremely hard abrasive materials. Cutting edge of tungsten carbide particles bonded to alloy steel back. High heat and abrasion resistance; no teeth to dull or chip; resists snagging; smooth cutting; greater wear resistance.



Model # E0320062

GRIT	SIZE LENGTH		APPLICATION		MODEL #	1/CARD MIN. ORDER QTY	PRODUCT CODE	BULK (50/PK)	
	INCHES	MM	TYPE OF CUT	MATERIAL				MODEL #	PRODUCT CODE
Universal Shank									
Coarse	2-7/8	73	Rough	Tile, Slate, Fiberglass	GJ6BL	5	E0406142	GJ6-50	E0206132
Medium	2-7/8	73	All Purpose	Tile, Slate, Fiberglass	GJ4BL	5	E0406141	GJ4-50	E0206131
Fine	2-7/8	73	Smooth	Tile, Slate, Fiberglass	GJ2BL	5	E0406140	--	--
Coarse	2-7/8 scroll	73	Rough	Tile, Slate, Fiberglass	GJ10BL	5	E0406144	--	--
Fine	2-7/8 scroll	73	Smooth	Tile, Slate, Fiberglass	GJ8BL	5	E0406143	--	--
Medium	4 - Flush	102	Rough	Tile, Slate, Fiberglass	GJ18BL	5	E0406146	--	--
T-Shank									
Medium	3	76	All Purpose	Tile, Slate, Fiberglass	GJ12BL	5	E0406148	GJ12-50	E0206138
Coarse	3	76	Rough	Tile, Slate, Fiberglass	GJ14BL	5	E0406147	GJ14-50	E0206137
Assortment Packs									
Assortment #1 includes: Qty 1 Circular Saw in 7" diameter, Qty 2 arbored hole saws in sizes: 1-1/4", 1-1/2" 2" & 2-1/2", Qty 5 jig saw blades in sizes: 2-7/8", 2-7/8" scroll, 3" T-shank, Qty 5 reciprocating blades in sizes: 6" & 8", Qty 10 hack saw blades size 12", Qty 10 rod saws size 12".									E0320062
Assortment #2 includes: Qty 4 arbored hole saws in sizes: 1-1/4", 1-1/2", 2" & 2-1/2", Qty 5 jig saw blades in sizes: 2-7/8", 2-7/8" scroll, 3" T-shank									E0320063
Assortment #3 includes: Qty 2 arbored hole saws in sizes: 1-1/4", 1-1/2", 2" & 2-1/2", Qty 2 jig saw blades in sizes: 2-7/8", 2-7/8" scroll, 3" T-shank									E0320065

BLU-MOL® BI-METAL AIR SAW BLADES



Specially designed blades for use in pneumatic saws. Air saw blades have fine teeth for cutting metal.



Air Saw Blades

SIZE			5/TUBE		
LENGTH			TEETH PER INCH	MODEL #	PRODUCT CODE
INCHES	MM				
3 x 1/2 x .025	75 x 12.5 x 0,64	18	6982	E0103178	
3 x 1/2 x .025	75 x 12.5 x 0,64	24	6983	E0103179	
3 x 1/2 x .025	75 x 12.5 x 0,64	32	6984	E0103180	
4 x 1/2 x .025	100 x 12.5 x 0,64	18	6985	E0103181	
4 x 1/2 x .025	100 x 12.5 x 0,64	32	6986	E0103182	
5 x 1/2 x .025	125 x 12.5 x 0,64	18	6987	E0103183	

Air Saw Blade Set

AIR BLADE SET	MODEL #	PRODUCT CODE
Includes (1) each of the following blades: 3" x 18T, 3" x 24T, 3" x 32T, 4" x 32T	6472	E0101319

BLU-MOL® BI-METAL HACKSAW BLADES



Bi-metal hacksaw blades for heavy duty cutting. Cut medium gauge metals (1/16" to 1/4") such as sheet metal, angle iron, bolts, channels, drill rods, threaded rod, pipes and tubing. Blade is shatter resistant.



Bi-Metal Hacksaw Blades

SIZE			2/CARD		10/CARD		100/TUBE	
LENGTH X WIDTH X THICKNESS			MODEL #	PRODUCT CODE	MODEL #	PRODUCT CODE	MODEL #	PRODUCT CODE
INCHES	MM	TPI						
10 x 1/2 x .025	250 x 12,5 x 0,64	18	1018UL-2	E0102857	1018UL-10	E0102858	--	--
10 x 1/2 x .025	250 x 12,5 x 0,64	24	1024UL-2	E0102859	1024UL-10	E0102860	--	--
10 x 1/2 x .025	250 x 12,5 x 0,64	32	1032UL-2	E0102861	1032UL-10	E0102862	--	--
12 x 1/2 x .025	304 x 12,5 x 0,64	18	1218UL-2	E0102865	1218UL-10	E0102866	1218UL	E0102867
12 x 1/2 x .025	304 x 12,5 x 0,64	24	1224UL-2	E0102868	1224UL-10	E0102869	1224UL	E0102870
12 x 1/2 x .025	304 x 12,5 x 0,64	32	1232UL-2	E0102871	1232UL-10	E0102872	1232UL	E0102873

MISC BLADES

RemGrit CARBIDE GRIT HACKSAW BLADES



Carbide particles bonded to a steel blade. This saw cuts extremely abrasive materials with no teeth to chip or dull. Carbide grit offers the greatest wear and heat resistance. Cuts on both strokes.



Carbide Grit Hacksaw Blades

SIZE			1/CARD		50/TUBE	
LENGTH X WIDTH X THICKNESS			MODEL #	PRODUCT CODE	MODEL #	PRODUCT CODE
INCHES	MM	GRIT				
10 x 3/4 x .025	250 x 19 x 0,64	MEDIUM	GH10	E0406161	GH10-50T	E0206151
12 x 3/4 x .025	304 x 19 x 0,64	MEDIUM	GH12	E0406160	GH12-50T	E0206150

MISC BLADES

RemGrit CARBIDE GRIT ROD SAW BLADES



Carbide particles bonded to an alloy steel rod. This saw cuts extremely abrasive materials with no teeth to chip or dull. Carbide grit offers the greatest wear and heat resistance. Ideal for materials that other saws will not cut. Rod design gets into tight areas and cuts on both strokes. Fits any standard hack frame.



Carbide Grit Rod Saw Blades

SIZE			1/CARD		50/TUBE	
LENGTH X DIAMETER		GRIT	MODEL #	PRODUCT CODE	MODEL #	PRODUCT CODE
INCHES	MM					
10 x .100	250 x 2,5	FINE GRIT	GG10	E0406181	GG10-50T	E0106174
12 x .100	300 x 2,5	MEDIUM	GG12	E0406180	GG12-50T	E0106175

RemGrit CARBIDE GRIT CIRCULAR SAW BLADES

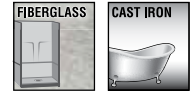

Cuts extremely hard abrasive materials. Cutting edge of tungsten carbide particles bonded to alloy steel back. High heat and abrasion resistance; no teeth to dull or chip; resists snagging; smooth cutting; greater wear resistance.

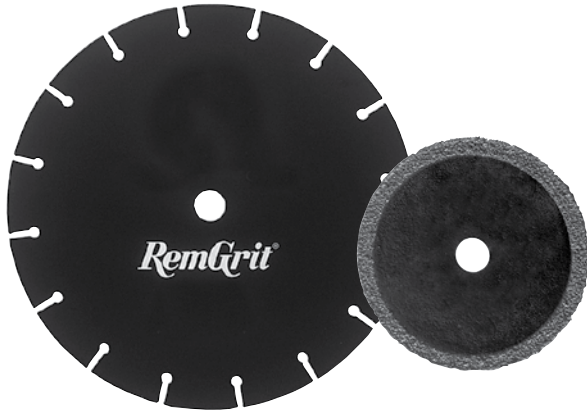

Carbide Grit Circular Saws

SIZE		GRIT	ARBOR SIZE	1/CARD		
DIAMETER				MODEL #	PRODUCT CODE	MAX RPM
INCHES	MM					
1-3/4	44	FINE	1/4"	GC101	E0206220	26,200
1-3/4	44	MEDIUM	1/4"	GC103	E0206221	26,200
1-3/4	44	COARSE	1/4"	GC107	E0206223	26,200
2	51	MEDIUM	1/4"	GC200	E0206224	23,600
2-1/2	64	COARSE	7/16"	GC250	E0206226	18,400
3	76	COARSE	1/2"	GC302	E0206227	15,200
3	76	COARSE	3/8"	GC304	E0206228	15,200
4	102	COARSE	20mm	GC406	E0206229	11,500
4	102	COARSE	3/4"	GC404	E0206231	11,500
4	102	COARSE	5/8"	GC408	E0206232	11,500
6-1/2	165	COARSE	1/2"-5/8"	GC652	E0206234	7,000
7	178	MEDIUM	1/2"-5/8"	GC700	E0206235	6,500
7	178	COARSE	1/2"-5/8"	GC703	E0206236	6,500
8	203	MEDIUM	1/2"-5/8"	GC803	E0206237	5,700
8	203	COARSE	1/2"-5/8"	GC805	E0206238	5,700
10	254	COARSE	5/8"	GC507	E0206240	4,600
12	305	COARSE	3/4"-1" Rnd	GC915	E0206242	3,800

MISC BLADES

Aggressor[®] PORTABLE BANDSAW BLADES



All teeth have uniform spacing and gulleted depth. Improved cut quality and shock resistance. Blades resist tooth strippage. Cuts aluminum, cast iron, chrome, stainless steel, tungsten steel and other problem materials at lower speed.

Portable Bandsaw Blades (Matrix II)



LENGTH X WIDTH X THICKNESS		QTY PER BOX	PITCH	TPI	MODEL #	PRODUCT CODE
INCHES	MM					
44-7/8 x 1/2 x .020	1140mm x 12.5mm x .50mm	3	VARIABLE	10/14	AG4412	E0102953
44-7/8 x 1/2 x .020	1140mm x 12.5mm x .50mm	100	VARIABLE	10/14	AG4412-100	E0102960
44-7/8 x 1/2 x .020	1140mm x 12.5mm x .50mm	3	VARIABLE	14/18	AG4416	E0102954
44-7/8 x 1/2 x .020	1140mm x 12.5mm x .50mm	100	VARIABLE	14/18	AG4416-100	E0102961
44-7/8 x 1/2 x .020	1140mm x 12.5mm x .50mm	3	VARIABLE	18/24	AG4420	E0102955
44-7/8 x 1/2 x .020	1140mm x 12.5mm x .50mm	100	VARIABLE	18/24	AG4420-100	E0102962
44-7/8 x 1/2 x .020	1140mm x 12.5mm x .50mm	3	CONSTANT	10 RAKER	B4410	E0102956
44-7/8 x 1/2 x .020	1140mm x 12.5mm x .50mm	100	CONSTANT	10 RAKER	B4410-100	E0102963
44-7/8 x 1/2 x .020	1140mm x 12.5mm x .50mm	3	CONSTANT	14 RAKER	B4414	E0102957
44-7/8 x 1/2 x .020	1140mm x 12.5mm x .50mm	100	CONSTANT	14 RAKER	B4414-100	E0102964
44-7/8 x 1/2 x .020	1140mm x 12.5mm x .50mm	3	CONSTANT	18 RAKER	B4418	E0102958
44-7/8 x 1/2 x .020	1140mm x 12.5mm x .50mm	100	CONSTANT	18 RAKER	B4418-100	E0102965
44-7/8 x 1/2 x .020	1140mm x 12.5mm x .50mm	3	CONSTANT	24 RAKER	B4424	E0102959
44-7/8 x 1/2 x .020	1140mm x 12.5mm x .50mm	100	CONSTANT	24 RAKER	B4424-100	E0102966

BANDSAW INDEX

Disston offers a complete range of bandsaws in various widths, pitches and tooth configurations for most cutting applications. We have a full offering of bi-metal bands, carbon bands and for highly abrasive materials, we offer our RemGrit carbide grit bands in both continuous and gulletted edges.



Aggressor® Bi-Metal Bandsaw Blades

Bi-Metal Bandsaw Blades have high speed steel teeth for a sharper cut and give you a longer lasting blade. HSS edge contains 8% cobalt. Available in coils or custom-welded to length.



RemGrit® Carbide Grit Gulletted Edge Bandsaw Blades

RemGrit® cuts through materials conventional tooth blades can't penetrate! Recommended for use in super alloys, fiberglass, honeycomb, foamed glass, hardened steel, graphite composites, fiber cement board and composite deck material.



RemGrit® Carbide Grit Continuous Edge Bandsaw Blades

RemGrit® cuts through materials conventional tooth blades can't penetrate! Recommended for use in super alloys, fiberglass, honeycomb, foamed glass, hardened steel, graphite composites, fiber cement board and composite deck material.



Aggressor® Hardback Carbon Bandsaw Blades

Carbon bandsaws are made for general cutting applications. They are ideal for straight and contour cutting. Use to cut carbon tool steels, tubing, solids, structurals, cast iron, and non-ferrous metals.



Aggressor® Flexback Carbon Bandsaw Blades

Carbon bandsaws are made for general cutting applications. They are ideal for straight and contour cutting. Use to cut carbon tool steels, tubing, solids, structurals, cast iron, and non-ferrous metals.

BANDSAW
BLADES

GUIDELINES FOR SUCCESSFUL BANDSAW OPERATION

Blade Width Selection

The dimension from tooth tip to back edge of the blade is the blade width. The greater the width, the greater the resistance to deflection while cutting. For straight cutting applications, use the widest blade the machine can accept. For contour cutting use the widest blade that the contour radius will permit. To cut close tolerance radii the following factors must be considered: blade width, material thickness, machinability, feed force, and location of pivot point.

Teeth Per Inch

The pitch of the blade is defined by the number of teeth per inch (TPI.) Nonferrous materials such as brass, bronze and aluminum require a large chip area. A low TPI, or "coarse pitch," prevents the chips from clogging and binding together in the gullets, which can diminish sawing and damage the blade.

On thin walled pipe, tubing, and sheet goods, many teeth per inch are required to avoid damaging or breaking the teeth. A low TPI blade is the best blade for cutting large cross-sections. The ability of each tooth to cut into the workpiece is increased because the saw's feed pressure is distributed over fewer teeth. A coarse pitch blade increases productivity and provides large chip clearing gullets.

Blade Break-In

Set bandsaw machine at recommended speed for material to be cut. When cutting easily machined metals, cutting rate should be set at 1/3 to 1/2 the recommended rate for the first 50 to 75 square inches.

When cutting difficult to machine metals, such as tool steels or work hardened alloys, set cutting rate at 75% of the recommended rate for the first 25 square inches. Gradually increase the feed until you achieve the recommended cutting rate after 50 to 60 square inches.

Tooth Selection

Tooth selection is based on the principle that there is a tooth pitch best suited for the cutting job. Blade selection should be based on the size, shape accuracy, material and cutting rate expected.

Keep in mind these numbers: 3, 6, 12, and 24. There should be a minimum of three teeth in the work at all times for bi-metal bands and a minimum of six teeth for carbon bands. Ideally, 6 – 12 teeth should be in contact with the work; 24 teeth in the work is too many.

Feed Pressure

Chips tell you what is happening with your feed pressure and your blade. Powdery or fine chips indicate that not enough feed pressure is being applied. Heavy, thick or blue burned chips mean you're pushing the blade too hard, creating too much heat and load for the teeth. Loosely curled chips tell you everything is going well. Speed should be determined by the class of material (this should remain constant.) Feed would be adjusted until desired chip formation is achieved.

MACHINE CHECKLIST



- The blade tension with a tension meter
- The performance of the chip brush
- The wear and alignment of the blade guides
- The band speed with a tachometer
- The cutting fluid concentration with a refractometer

CUTTING FLUID

The cutting fluid keeps the blade teeth cool, it prevents the chips from welding to the tooth, and also lubricates the chips, allowing them to move through the cut.

- Use a high quality cutting fluid
- Make sure the cutting fluid is distributed throughout the cut

TOOTH PITCH SELECTION

For lowest cost per cut, always select the narrowest cross section of the material to be cut for added beam strength, more teeth in cut, longer life, higher band speed, and shortest cut time.

Solid Square & Rectangle

Tooth Pitch   **Cut Width**
Material Thickness

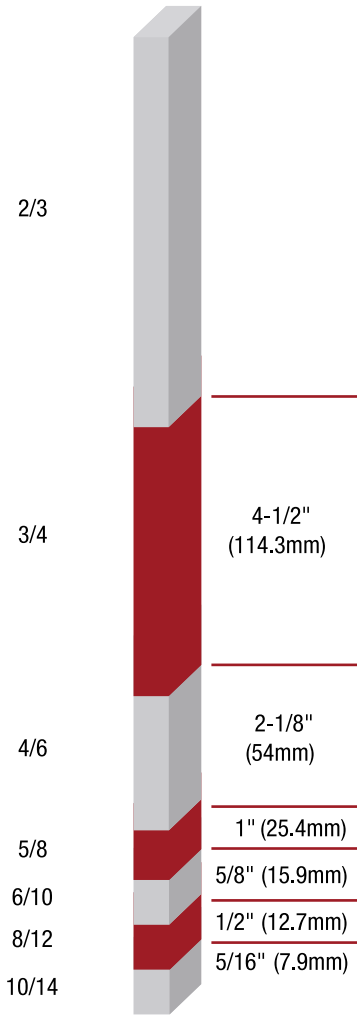

Solid Round

Tooth Pitch  **Cut Width**
Material Thickness

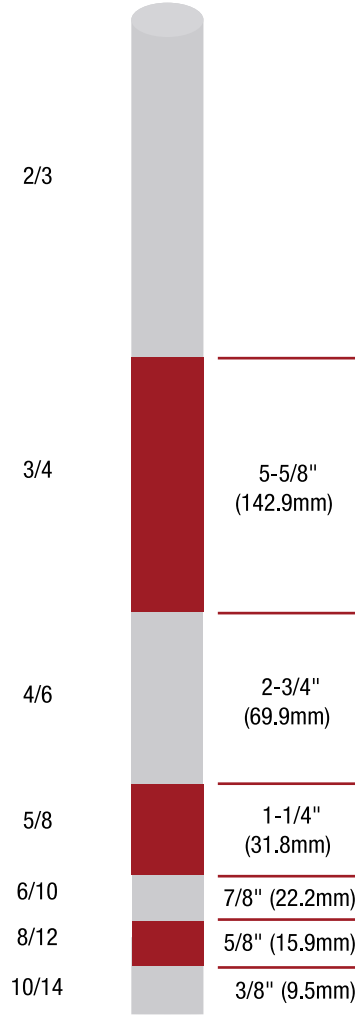

Structurals

Tooth Pitch  **Average Cut Width**
Material Thickness

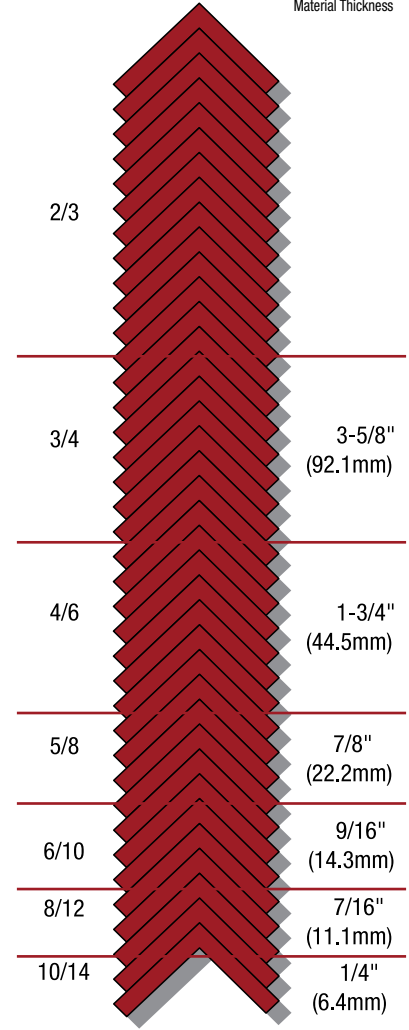

Area = pounds per foot x .294

Aluminium Structural Area - pounds per foot x .85

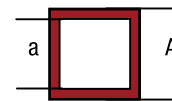

A - a = area

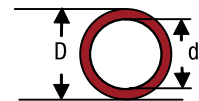

$D = .7854 \times D^2$

$d = .7854 \times d^2$

$D - d = \text{area}$

$\pi r^2 = \text{area}$

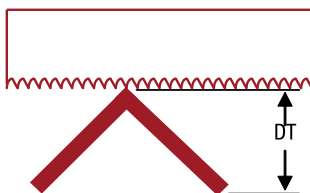

Horizontal Machine

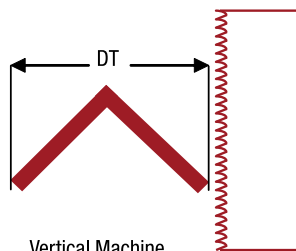

Vertical Machine

$$\frac{\text{area}}{(\text{DT}) \text{ distance of travel}} = \text{average cut width}$$

BANDSAW TERMS

Tooth Form

Positive rake. A positive rake tooth angles forward in the direction of the cutting action. Higher positive rake angles give the most aggressive tooth penetration for easier chip formation. This tooth form is recommended for cutting difficult-to-machine materials, solids, and solid cross sections.

Straight tooth. A straight tooth has a 0° cutting face, and is recommended for cutting easy-to-cut, low alloy materials as well as interrupted cuts.

Tooth Set

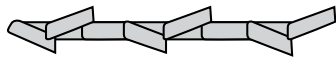

Raker set. These are individually set teeth – first right then left – followed by an unset tooth. The unset tooth (raker tooth) allows for fast chip removal and a straight cutting action. This tooth set is recommended for general purpose cutting applications.



Wavy set. Wavy set teeth are set in groups, right and left, in varying degrees. Wavy set teeth are recommended for cutting light metal sections, such as sheet, tubing and small solid shapes.

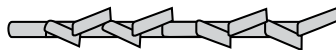

Modified raker set. Variable set teeth are set in alternating groups with a single unset tooth (raker tooth). When these are combined with the varying set angles of the teeth, a faster, smoother, and quieter cutting action is achieved. Variable tooth blades perform extremely well on most applications and provide fast cutting on solids, shapes, structurals and piping.

Tooth Type



Regular. This is a conventional tooth with a 0° rake angle, ideal for a wide range of general purpose cutting applications.



Hook. This tooth type has a 10° positive rake angle for fast cutting with less feed pressure. The rounded gullets allow for fast chip removal and are generally used for cutting nonmetallics and nonferrous metals.



Skip. This tooth type has a 0° rake angle with shallow gullets and evenly spaced teeth for efficient chip removal. It is used for cutting large sections of soft, nonferrous metal and nonmetal material, such as wood, composition materials, cork and plastic.



Variable. A traditional tooth form that offers a 0° rake angle, varying gullet depths and tooth sizes. Designed to reduce harmonic vibration, this blade efficiently removes chips, extending blade life in solids and structurals.



Variable Positive. Variable positive tooth form offers varying gullet depth, tooth sizes and a positive rake angle for maximum cutting speeds and better tooth penetration in harder to machine materials.



Duplex. Duplex blades offer deep, chip clearing gullets, increased tooth strength, and a high positive rake angle. This results in faster sawing rates and improved finishes. Duplex blades are recommended for production cutting work hardened metals, tool steels, and exotic alloys.

RECOMMENDED BANDSAW OPERATING SPEEDS (FPM TABLE)

BAND SPEEDS

based on 4" material

INCREASE

for smaller sizes 2" +10%

DECREASE

for larger sizes 6" -10%

CARBON STEELS		ALLOY STEELS		TOOL & MOLD STEELS		STAINLESS STEELS		SUPER ALLOYS	
MATERIAL	FPM	MATERIAL	FPM	MATERIAL	FPM	MATERIAL	FPM	MATERIAL	FPM
1008	320	150	250	A10	160	230	150	A286	90
1015	320	1330	220	A2	180	303	140	Astroloy	60
1018	300	1345	210	A6	200	304	120	Hastelloy	70
1020	320	4130	270	D2	90	309	90	Incoloy 800	90
1021	300	4140	250	H11	190	310	80	Incoloy 900	60
1022	300	4145	210	H12	190	316	100	Inconel	60
1025	320	4340	220	H13	190	324	100	Inconel 625	100
1026	300	5160	220	L6	190	347	110	Monel	70
1030	330	6150	210	M1	110	410	140	Nickel 200	80
1035	310	8616	240	M42	100	414	110	Pyromet X15	120
1040	270	8620	240	O1	200	416	190	Titanium	70
1042	250	8630	220	O6	190	420	190	Waspalloy	70
1044	220	8640	200	P20	230	430	150	WF11	60
1045	220	9310	170	S1	200	431	90		
1060	200	52100	160	S5	140	450	80		
1095	180	300M	160	S7	120	502	140		
1117	340	41L40	270	T1	100	2205	80		
1137	290	A242	280	T15	70	18-8-2	90		
1141	280	e.t.d.	250	W1	220	22-13-5	60		
1144	280	HP 9-4-20	100			440C	80		
1213	380	HP 9-4-25	100			440F	160		
1215	380	HY-100	160			M225	90		
1513	300	HY-80	160			Nitronic 50	60		
1541	250					Nitronic 60	60		
A36	270					SS-PH	80		

BLADE BREAK-IN

It is important to run all new bandsaw blades at a reduced rate to break them in. This helps to remove any uneven edges that are imparted on cutting tools during the manufacturing processes, and can double the life of the blade.

To break in a blade:

- 1) Set machine to the recommended band speed for the material being cut.
- 2) Multiply the recommended cut time by:
 - a. 2 – for band speeds 250 fpm and higher
 - b. 1.75 – for band speeds 175 to 250 fpm
 - c. 1.5 – for band speeds 120 to 175 fpm
 - d. 1.25 – for band speeds 80 to 120 fpm
 - e. Band speeds less than 80 fpm require minimal break-in
- 3) Gradually increase cutting rate to proper cut time over the next:
 - a. 80 to 100 sq. in.
 - b. 60 to 80 sq. in.
 - c. 40 to 60 sq. in.
 - d. 20 to 40 sq. in.
 - e. 20 or less sq. in.

FEEDS

Tooth Pitch	10/14	8/12	6/10	5/8	5/7	4/6	3/4	2/3
Multiplier Rate (MR)	.047	.039	.031	.025	.024	.020	.014	.010
(mm)	(1.19)	(.99)	(.79)	(.64)	(.61)	(.51)	(.36)	(.25)

After determining proper tooth pitch and band speed, select the rate MR (multiplier rate) for the tooth pitch being considered and use this formula to determine feedrate:

$$\text{Band Speed} \times \text{MR} = \text{Linear Inches per Minute Rate}$$

For the lowest cost per cut, always select/position the material to obtain the narrowest cross section to be cut for added beam strength, more teeth in cut, longer tool life, higher band speed, and quickest cut time.

When stacking material, multiply the area of each piece by the number of pieces, then divide by the DT (distance of travel) to obtain average cut width for selection of proper tooth pitch.

When using a smaller tooth pitch than normal, use the MR (multiplier rate) listed for the proper selection to minimize over-filling the gullets of the smaller teeth.

For increased production, after determining the beam strength, material clamping, coolant, tooth pitch, and machine condition are all appropriate, the MR (multiplier rate) can be increased up to 25%.

$$\frac{(\text{DT}) \text{ distance of travel}}{\text{Linear in/min}} = (\text{CT}) \text{ cut time}$$

Example 1:
4" X 6" 8620, band speed 240 fpm, recommended tooth pitch 3/4 cutting the 4" width = MR .014
 $240 \times .014 = 3.36 \text{ linear in/min}$

Horizontal Machine Vertical Machine

$$\frac{6" (\text{DT})}{3.36 \text{ L in/min}} = 1.79 \text{ min (CT)}$$

(1 min. 47 sec.)

Example 2:
4" X 6" 8620, band speed 215 fpm, recommended tooth pitch 2/3 cutting the 6" width = MR .010 $215 \times .010 = 2.15 \text{ linear in/min}$

Horizontal Machine Vertical Machine

$$\frac{4"}{2.15} = 1.86 \text{ min (CT)}$$

(1 min. 52 sec.)

Example 3:
4" X 6" 8620, band speed 240 fpm, recommended tooth pitch 3/4 cutting the 4" width = MR .014
 $240 \times .014 = 3.36 \text{ linear in/min}$

Horizontal Machine Vertical Machine

$$\frac{6" (\text{DT})}{3.36 \text{ L in/min}} = 1.79 \text{ min (CT)}$$

(1 min. 47 sec.)

Example 4:
4" X 6" 8620, band speed 215 fpm, recommended tooth pitch 2/3 cutting the 6" width = MR .010
 $215 \times .010 = 2.15 \text{ linear in/min}$

Horizontal Machine Vertical Machine

$$\frac{4" (\text{DT})}{2.15 \text{ L in/min}} = 1.86 \text{ min (CT)}$$

(1 min. 52 sec.)

Example 5:
2" dia. SS304, band speed 132 fpm, recommended tooth pitch 4/6 cutting the 2" width = MR .020
 $132 \times .020 = 2.64 \text{ linear in/min}$

Horizontal Machine Vertical Machine

$$\frac{2" (\text{DT})}{2.64 \text{ L in/min}} = .75 \text{ min (CT)}$$

(45 sec.)

Example 6:
4" X 6", 1/4" wall A36, band speed 270 fpm, recommended tooth pitch 5/8 cutting the .79" avg. cut width = MR .025
 $270 \times .025 = 6.75 \text{ linear in/min}$

Horizontal Machine Vertical Machine

$$\frac{6" (\text{DT})}{6.75 \text{ L in/min}} = .88 \text{ min (CT)}$$

(53 sec.)

Example 7:
1" beam, 37.41 lbs/ft A36, band speed 240 fpm, recommended tooth pitch 3/4 cutting the 1.83" avg. cut width = MR .014
 $240 \times .014 = 3.36 \text{ linear in/min}$

Horizontal Machine Vertical Machine

$$\frac{4" (\text{DT})}{3.36 \text{ L in/min}} = 1.19 \text{ min (CT)}$$

(1 min. 11 sec.)

Example 8:
2" angle 1/4" wall A36, band speed 300 fpm, recommended tooth pitch 5/8 cutting the .7" avg. cut width = MR .025
 $300 \times .025 = 7.5 \text{ linear in/min}$

Horizontal Machine Vertical Machine

$$\frac{1.4" (\text{DT})}{7.5 \text{ L in/min}} = .19 \text{ min (CT)}$$

(11 sec.)

Aggressor® BI-METAL BANDSAW BLADES

Bi-Metal Bandsaw Blades have high speed steel teeth for a sharper cut and give you a longer lasting blade. HSS edge contains 8% cobalt. Available in coils or custom-welded to length.

Narrow Width Bands (M-42 & Matrix II)

- Solids and thick wall tubing of medium to difficult material, such as stainless steels
- 5° positive rake for easier penetration and reduced vibration
- Narrow width from 1/4" to 1/2" for contour and miter cutting
- Narrow width and gauge can be welded by customer for die building and internal cutting re-use
- HSS Edge contains 8% cobalt



0° Rake

WIDTH X GAUGE			VARIABLE PITCH			CONSTANT PITCH					
INCH	MM	COIL LENGTH	MODEL # / PRODUCT CODE			MODEL # / PRODUCT CODE					
			6/10	8/12	10/14	4 HOOK	10 RAKER	14 RAKER	18 WAVY	24 RAKER	24 WAVY
1/4 x .035	6,00 x 0,90	250 ft.	--	--	--	--	A906 E0104611	A907 E0104612	--	--	--
3/8 x .035	10,0 x 0,90	250 ft.	--	--	A915 E0104613	A911 E0104614	--	--	--	--	--
1/2 x .020	12,5 x 0,51	250 ft.	--	--	A821* E0102972	--	A822* E0102973	A823* E0102974	A824* E0102975	A826* E0104522	A825* E0102976
1/2 x .025	12,5 x 0,64	250 ft.	A902 E0102889	A905 E0102890	A901 E0102891	--	--	A931 E0104616	A900 E0102892	--	--
1/2 x .035	12,5 x 0,90	250 ft.	--	A919 E0104617	A936 E0104618	A937 E0104628	--	A933 E0104620	--	--	--

M-1000 M-42 (Straight Tooth)

- All-purpose band for moderate to difficult to cut materials
- Provides higher heat and wear durability
- 0° for smoother cutting and general applications

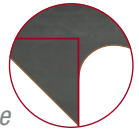

0° Rake

WIDTH X GAUGE			VARIABLE PITCH						CONSTANT PITCH	
INCH	MM	COIL LENGTH	MODEL # / PRODUCT CODE						MODEL # / PRODUCT CODE	
			3/4	4/6	5/8	6/10	8/12	10/14	10 RAKER	14 WAVY
3/4 x .035	19,0 x 0,90	250 ft.	--	--	--	A934 E0104621	A932 E0104622	A952 E0104623	A943 E0104624	A944 E0104625
1 x .035	27,0 x 0,90	250 ft.	A976 E0102893	A974 E0102894	A975 E0102895	A970 E0102896	A971 E0102897	A920 E0102898	--	A973 E0102899
1-1/4 x .042	34,0 x 1,10	250 ft.	A965 E0102900	A964 E0102901	A966 E0102902	--	--	--	--	--
1-1/2 x .050	41,0 x 1,27	250 ft.	--	A980 E0102904	--	--	--	--	--	--

M-2000 M-42 (Positive Rake Tooth)

- Solids and thick wall tubing of medium to difficult material, such as stainless steels
- 5° positive rake for easier penetration and reduced vibration



5° Positive Rake

WIDTH X GAUGE			VARIABLE PITCH			CONSTANT PITCH	
INCH	MM	COIL LENGTH	MODEL # / PRODUCT CODE			MODEL # / PRODUCT CODE	
			3/4	4/6	5/7	6 RAKER	8 RAKER
3/4 x .035	19,0 x 0,90	250 ft.	--	A9035 E0102905	A904 E0102906	--	--
1 x .035	27,0 x 0,90	250 ft.	A9285 E0102908	A9295 E0102909	A930 E0102910	A922 E0102914	A923 E0102915
1-1/4 x .042	34,0 x 1,10	250 ft.	A9615 E0102917	A9625 E0102918	A963 E0102919	A955 E0102922	--
1-1/2 x .050	41,0 x 1,27	250 ft.	A9785 E0102924	A9795 E0102925	--	--	--

* Black Box denotes Matrix II material.
When ordering custom welded lengths use the Model # followed by a "W" and your exact weld length.

M-3000 M-42 (High Positive Rake Tooth)

- High production band for difficult to cut materials, such as monels, titanium, inconels, and stainless steels, etc.
- Greater beam strength
- Specially engineered relief angle
- 10° high positive rake for faster cutting time
- Designed for maximum strength when cutting difficult materials such as super alloys



10° high positive rake with DUPLEX tooth

INCH	WIDTH X GAUGE		VARIABLE PITCH		
	MM	COIL LENGTH	MODEL # / PRODUCT CODE		
			2/3	3/4	4/6
3/4 x .035	19,0 x 0,90	250 ft.	--	--	A903 E0102929
1 x .035	27,0 x 0,90	250 ft.	A927 E0102930	A928 E0102931	A929 E0102932
1-1/4 x .042	34,0 x 1,10	250 ft.	A960 E0102933	A961 E0102934	A962 E0102935
1-1/2 x .050	41,0 x 1,27	250 ft.	A977 E0102936	A978 E0102937	A979 E0102938
2 x .063	54,0 x 1,60	150 ft.	A981 E0102940	A982 E0102941	A983 E0104608

M-4000 M-42 (Heavy Set)

- For large and bundle cutting of structural steel
- Ideal for applications where a larger kerf is needed to prevent blade pinching and stalling from material stresses and movement



Positive Rake

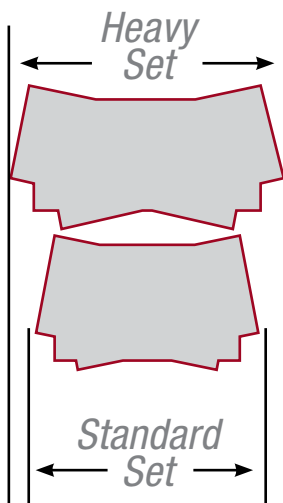

INCH	WIDTH X GAUGE		VARIABLE PITCH		
	MM	COIL LENGTH	MODEL # / PRODUCT CODE		
			3/4	4/6	5/7
1 x .035	27,0 x 0,90	250 ft.	--	AXS929 E0102943	AXS930 E0104954
1-1/4 x .042	34,0 x 1,10	250 ft.	AXS961 E0102945	AXS962 E0102946	AXS989 E0102947
1-1/2 x .050	41,0 x 1,27	250 ft.	AXS978 E0102948	AXS979 E0102949	--

When ordering custom welded lengths use the Model # followed by a "W" and your exact weld length.

RemGrit® CARBIDE GRIT BANDSAW BLADES

RemGrit® cuts through materials conventional tooth blades can't penetrate! Recommended for use in super alloys, fiberglass, honeycomb, foamed glass, hardened steel, graphite composites, fiber cement board and composite deck material.



GULLETED EDGE

- Tungsten carbide grit bonded to an alloy steel back
- Carbide particle placement enables band to be run in either direction
- Unequalled life and cutting performance for hard or abrasive material



CONTINUOUS EDGE

- Use continuous edge for material less than 1/4" thick or for hard material with a tendency to fracture, crack, or chip easily
- Carrier wheels should be a minimum of 24" diameter

WIDTH X GAUGE			GULLETED						CONTINUOUS			
INCH	MM	COIL LENGTH	MODEL # / PRODUCT CODE									
			MEDIUM	MEDIUM COARSE	COARSE (EXTRA TEMPER) TIRE CUTTING	COARSE	COARSE (SHORT TOOTH)	COARSE (DEEP GULLET)	MEDIUM	MEDIUM COARSE	COARSE	
1/4 x .020	6,00 x 0,51	250 ft.	308 E0206312	--	--	--	--	--	--	310 E0206313	--	--
3/8 x .025	10,0 x 0,89	250 ft.	322 E0206314	324 E0206315	--	--	--	--	--	328 E0206317	--	--
1/2 x .020	12,5 x 0,51	250 ft.	335 E0206318	--	--	--	--	--	--	337 E0206320	338 E0206321	--
1/2 x .025	12,5 x 0,64	250 ft.	330 E0206322	331 E0206323	--	--	--	--	--	333 E0206325	334 E0206326	--
3/4 x .032	19,0 x 0,81	250 ft.	341 E0206327	--	--	344 E0206329	--	--	--	346 E0206330	--	349 E0206332
1 x .035	25,0 x 0,89	250 ft.	--	350 E0206333	381 E0102553	351 E0206334	--	--	352 E0206335	--	--	357 E0206340
1-1/4 x .035	32,0 x 0,89	250 ft.	--	--	--	--	--	--	362 E0206343	--	--	363 E0206344
1-1/4 x .042	32,0 x 1,07	250 ft.	--	--	--	--	--	--	365 E0206346	--	--	--
1-1/2 x .042	38,0 x 1,07	250 ft.	--	--	--	--	374 E0206348	--	--	--	--	--

Recommended Band Speeds

BLADE	SFPM	MATERIAL	BLADE	SFPM	MATERIAL
Coarse	150 - 200	Tool Steel (HrC 42-65)	Medium	200-1200	Green Unfired Ceramics
Med. Coarse	150 - 300	Nitride Case Hardened and Inductive Hardened Steels	Med. Coarse	800-1500	Fiber Reinforced Cement
Coarse	150 - 400	High-Temp Nickel and Iron Base Super Alloys	Med. Coarse	1000-3000	Friction Materials
Coarse	120 - 300	Hastelloys	Medium	4000-6000	Fiberglass Honeycomb
Med. Coarse	150 - 500	Aircraft and Sheet Stainless	Medium	1000-3000	Fiberglass Reinforced Plastics (polymers, epoxies, melamine, phenolics)
Coarse	150 - 600	Beryllium	Medium	1500-3000	Graphite Composites
Med. Coarse	125 - 700	Sintered Tungsten, Molybdenum, Iron, and Stainless	Medium	200-1000	Aircraft Tooling and Molding Compounds
Med. Coarse	125 - 300	Welds and Met-Lab Specimens	Coarse	1000-4000	Carbon and Graphite
Coarse	150 - 350	White and High Alloy Cast Iron	Medium	500-1000	Glass
Coarse	150 - 300	Grey Cast Iron	Coarse	1200-3000	Wire Reinforced Rubber
Coarse	150 - 400	Titanium	Medium	1200-3000	Cable and Wire Rope
Med. Coarse	1000 - 3000	Foamed Glass	Coarse	400-1600	Compressed Perlite Molding Compounds
Med. Coarse	300 - 700	Syntactic Foam	Med. Coarse	120-500	Cement Lined Steel and Cast Iron Pipe
Medium	500 - 1500	Low Density Ceramics	Coarse	150-600	Soapstone, Chalk, Lava, Slate, and Coal

Shading indicates coolant recommended.

When ordering custom welded lengths use the Model # followed by a "W" and your exact weld length.

Aggressor® CARBON BANDSAW BLADES

Carbon bandsaws are made for general cutting applications. They are ideal for straight and contour cutting. Use to cut carbon tool steels, tubing, solids, structurals, cast iron, and non-ferrous metals.



HARDBACK CARBON

- Solid Carbon Steel
- Tooth hardness 62 HRc - 66 HRc
- Back hardened up to 45 HRc for straight cuts
- Supports heavier feed pressure

WIDTH x GAUGE			CONSTANT PITCH								
INCH	MM	COIL LENGTH	MODEL # / PRODUCT CODE								
			3 SKIP	4 SKIP	6 SKIP	6 RAKER	8 RAKER	10 RAKER	14 RAKER	18 RAKER	24 RAKER
1/4 x .025	6,00 x 0,64	250 ft.	--	211 E0103018	213 E0103020	--	--	214 E0103021	215 E0103022	216 E0103023	217 E0103024
3/8 x .025	10,0 x 0,64	250 ft.	--	223 E0103027	--	--	--	226 E0103029	227 E0103030	228 E0103031	--
1/2 x .025	12,5 x 0,64	250 ft.	--	234 E0103034	--	236 E0103036	--	237 E0103037	239 E0103039	241 E0103041	243 E0103043
3/4 x .032	19,0 x 0,81	250 ft.	262 E0103045	--	--	264 E0103047	265 E0103048	267 E0103049	271 E0103051	--	--
1 x .035	25,0 x 0,89	250 ft.	--	--	--	280 E0103056	--	282 E0103057	284 E0103059	--	--
1 1/4 x .042	6,0 x 1,07	500 ft.	--	--	--	295 E0214871	--	--	--	--	--
			2 HOOK	3 HOOK	4 HOOK	6 HOOK	10 WAVY	14 WAVY	18 WAVY	24 WAVY	
1/4 x .025	6,0 x 0,64	250 ft.	--	--	210 E0103017	212 E0103019	--	--	--	--	
3/8 x .025	10,0 x 0,64	250 ft.	--	220 E0103025	222 E0103026	224 E0103028	--	--	--	--	
1/2 x .025	12,5 x 0,64	250 ft.	--	231 E0103032	233 E0103033	235 E0103035	238 E0103038	240 E0103040	--	242 E0103042	
3/4 x .032	19,0 x 0,81	250 ft.	--	261 E0103044	--	263 E0103046	268 E0103050	272 E0103052	273 E0103053	--	
1 x .035	25,0 x 0,89	250 ft.	275 E0103054	277 E0103055	--	--	283 E0103058	--	--	--	



FLEXBACK CARBON

- Solid Carbon Steel
- Tooth hardness 62 HRc - 66 HRc
- Back hardened up to 38 HRc for contour cutting
- Available in 250 ft. coils or custom-welded to length
- Cuts wood, cast iron, brass, aluminum, zinc, copper, mild steels, non-ferrous metals, fiberglass, plastic, bronze, and lead

WIDTH x GAUGE			CONSTANT PITCH								
INCH	MM	COIL LENGTH	MODEL # / PRODUCT CODE								
			3 SKIP	4 SKIP	6 SKIP	6 RAKER	8 RAKER	10 RAKER	14 RAKER	18 RAKER	24 RAKER
1/4 x .025	6,0 x 0,64	250 ft.	--	041 E0103061	043 E0103063	--	--	044 E0103064	046 E0103065	047 E0103066	048 E0103067
3/8 x .025	10,0 x 0,64	250 ft.	--	063 E0103070	--	--	065 E0103072	066 E0103073	068 E0103074	069 E0103075	--
1/2 x .025	12,5 x 0,64	250 ft.	--	094 E0103078	--	097 E0103080	--	098 E0103081	100 E0103082	102 E0103084	104 E0103085
3/4 x .032	19,0 x 0,81	250 ft.	142 E0103089	--	--	144 E0103091	146 E0103092	148 E0103093	152 E0103095	154 E0103097	--
1 x .035	25,0 x 0,89	250 ft.	172 E0103100	--	--	174 E0103101	175 E0103102	176 E0103103	--	--	--
			2 HOOK	3 HOOK	4 HOOK	6 HOOK	14 WAVY	24 WAVY			
1/4 x .025	6,0 x 0,64	250 ft.	--	--	040 E0103060	042 E0103062	--	--			
3/8 x .025	10,0 x 0,64	250 ft.	--	060 E0103068	062 E0103069	064 E0103071	--	--			
1/2 x .025	12,5 x 0,64	250 ft.	--	091 E0103076	093 E0103077	096 E0103079	101 E0103083	105 E0103086			
3/4 x .032	19,0 x 0,81	250 ft.	--	141 E0103088	139 E0103087	143 E0103090	--	--			
1 x .035	25,0 x 0,89	250 ft.	170 E0103098	171 E0103099	--	--	--	--			

When ordering custom welded lengths use the Model # followed by a "W" and your exact weld length.

FASTENERS INDEX

Make quick work of any fastener project. Blu-Mol driving bits, sets, adaptors, and guides handle a wide variety of tough jobs. Blu-Mol fasteners are hardened and tempered for longer life.



Blu-Mol[®] Phillips Bit



Blu-Mol[®] Star Bit



Blu-Mol[®] Hex Bit



Blu-Mol[®] Slotted Bit



Blu-Mol[®] Square Bit



Blu-Mol[®] Double End Bit



Blu-Mol[®] Adaptor



Blu-Mol[®] Bit Extension

FASTENER USE SAFETY

READ THIS BEFORE USING PRODUCTS

WARNING: Failure to obey safety instructions and warnings can result in injury or death. Wear ANSI-compliant eye protection. Do not twist tool or work piece when cutting; Disconnect electricity to work piece.

IMPORTANT: BE SURE to read, understand and follow all warnings, safety rules, instructions and labels in the Operator's Manual and on power tool itself. Failure to do so can result in serious personal injury.



ALWAYS WEAR PROPER safety goggles, safety glasses with side shields, a full-face shield when needed, proper respiration protection and hearing protection when operating power tools.

BLU-MOL® FASTENERS

Blu-mol Fastener Bits are made with quality S2 steel material for long life and durability.

Bits



SIZE		TYPE	QTY	MODEL #	PRODUCT CODE
INCH	#				
Phillips 					
1"	#1	Insert	2	00075	E0100075
1"	#1	Insert	25 - Tic Tac Box	00753	E0100753
2"	#1	--	1	00076	E0100076
4"	#1	--	1	00099	E0100099
6"	#1	--	1	00100	E0100100
1"	#3	Insert	2	00681	E0100681
2"	#3	--	1	00682	E0100682
4"	#3	--	1	00683	E0100683
6"	#3	--	1	00684	E0100684
1"	#2	Insert	2	00735	E0100735
1"	#2	Insert	25 - Tic Tac Box	00739	E0100739
1"	#2	Insert	500 - Tub	00029	E0100029
2"	#2	--	1	00736	E0100736
2"	#2	--	18 - Tic Tac Box	00740	E0100740
2"	#2	--	250 - Tub	00028	E0100028
4"	#2	--	1	00737	E0100737
6"	#2	--	1	00738	E0100738
2"	#2	Drywall	1	00755	E0100755
2"	#2	Drywall	18 - Tic Tac Box	00756	E0100756
Slotted 					
1"	6-8	--	2	00818	E0100818
2"	6-8	--	1	00819	E0100819
4"	6-8	--	1	00820	E0100820
1"	8-10	--	2	00821	E0100821
2"	8-10	--	1	00822	E0100822
4"	8-10	--	1	00823	E0100823
1"	10	--	2	00824	E0100824
2"	10-12	--	1	00825	E0100825
4"	10-12	--	1	00826	E0100826
Square 					
1"	#1	Recess	2	00054	E0100054
2"	#2	Recess	1	00055	E0100055
1"	#2	Recess	2	00056	E0100056
1"	#2	Recess	25 - Tic Tac Box	00058	E0100058
2"	#2	Recess	1	00057	E0100057
2"	#2	Recess	25 - Tic Tac Box	00059	E0100059
2"	#2	Recess	250 - Tub	00062	E0100062
1"	#3	Recess	2	00060	E0100060
2"	#3	Recess	1	00061	E0100061
--	#2	Drywall Recess	1	00754	E0100754



SIZE		TYPE	QTY	MODEL #	PRODUCT CODE
INCH	#				
Hex 					
1"	5/64"	Key	2	00307	E0100307
1"	3/32"	Key	2	00308	E0100308
1"	7/64"	Key	2	00309	E0100309
1"	1/8"	Key	2	00310	E0100310
1"	9/64"	Key	2	00311	E0100311
Star 					
1"	T8	Insert	1	00011	E0100011
1"	T9	--	2	00012	E0100012
1"	T10	--	1	00108	E0100108
1"	T10	--	2	00013	E0100013
2"	T10	Security	1	00014	E0100014
1"	T15	Security	1	00109	E0100109
1"	T15	--	2	00015	E0100015
2"	T15	--	1	00016	E0100016
1"	T20	Security	1	00110	E0100110
1"	T20	--	2	00017	E0100017
2"	T20	--	1	00018	E0100018
1"	T25	Security	1	00111	E0100111
1"	T25	--	2	00019	E0100019
2"	T25	--	1	00020	E0100020
1"	T27	Security	1	00112	E0100112
1"	T27	--	2	00021	E0100021
2"	T27	--	1	00022	E0100022
1"	T30	Security	1	00113	E0100113
1"	T30	--	2	00023	E0100023
2"	T30	--	1	00024	E0100024
1"	T40	--	2	00025	E0100025
Double-End 					
--	#1, 6-8	Phillips Insert	1	00089	E0100089
--	#2, 8-10	Phillips Insert	1	00090	E0100090
--	#3, 10-12	Phillips	1	00091	E0100091
2"	#2	Phillips	250 - Tub	00092	E0100092

BLU-MOL® FASTENERS
Sets

# PCS.	SIZE	DESCRIPTION	MODEL #	PRODUCT CODE
6	1/4" Shank	Quick Release Drywall Screwsetter Set	00026	E0100026
3	1/4" Shank	Quick Change Adjustable Drive Set	00041	E0100041
5	1/4" Shank	Power Screwdriver Bit Set	00043	E0100043
10	1/4" Shank	Quick Change Drill Drive Set Tin Bits	00044	E0100044
10	1/4" Hex Shank	Quick Connect Drill Drive Set	00045	E0100045
10	3/16" - 7/16"	Magnetic Nutsetter Set	00046	E0100046
14	1", 1/4" Shank	Assorted 1" Quick Change Screwsetter Set	00047	E0100047
29	--	Screwdriver Bit Set	00048	E0100048
30	1/4" Shank	Quick Change Titanium Drill Drive Set	00049	E0100049
33	--	Security Star Bit Set	00050	E0100050
40	--	Screwdriver Bit Set	00051	E0100051
54	1/4" Shank	Screwdriver Bit Set	00052	E0100052
24	1/4" Shank	Titanium Drill Driver Set	00764	E0100764
83		Quick Change Drill Drive Set	00031	E0100031
100		Drill Driver Set	00135	E0100135

Adaptors

INCH	SIZE	# PCS.	DESCRIPTION	MODEL #	PRODUCT CODE
11"	1/4" Shank	1	Flex & Hold Adaptor	00035	E0100035
6"	1/4" Shank	1	Flex & Hold Extension	00042	E0100042
1/4"	1/4" Shank	1	Socket Adaptor	00063	E0100063
3/8"	1/4" Shank	1	Socket Adaptor	00064	E0100064
1/2"	1/4" Shank	1	Socket Adaptor	00065	E0100065
1/4"	1/4" Shank	1	Quick Change Connector / Adaptor	00114	E0100114
--	1/4" Shank	5	Quick Change Adaptor Set (Hex)	00115	E0100115
--	--	3	Quick Change Adaptor Set (Phillips)	00116	E0100116

Guides

INCH	SIZE	# PCS.	DESCRIPTION	MODEL #	PRODUCT CODE
3"	1/4" Shank	1	Screwdriver Guide	00037	E0100037
5"	1/4" Shank	1	Screwdriver Guide	00038	E0100038
3" & 5"	1/4" Shank	2	Screwdriver Guide Set	00039	E0100039
1/4" x 1-7/8"	1/4" Shank	1	Magnetic Nutsetter	00757	E0100757
5/16" x 1-7/8"	1/4" Shank	1	Magnetic Nutsetter	00760	E0100760
5/16" x 1-7/8"	1/4" Shank	50 - Tub	Magnetic Nutsetter	00758	E0100758
--	#2	1	Phillips Drywall Screwdriver Setter	00759	E0100757
3/8" x 1-7/8"	1/4" Shank	1	Magnetic Nutsetter	00761	E0100761
7/16" x 1-7/8"	1/4" Shank	1	Magnetic Nutsetter	00762	E0100762
1/2" x 1-7/8"	1/4" Shank	1	Magnetic Nutsetter	00763	E0100763
2"	1/4" Shank	1	Magnetic Screwdriver Bit Holder	00765	E0100765
3"	1/4" Shank	1	Magnetic Screwdriver Bit Holder	00766	E0100766
4"	1/4" Shank	1	Magnetic Screwdriver Bit Holder	00767	E0100767

ONE-YEAR LIMITED WARRANTY POLICY

1. Definitions

“Product” or “Products” means any product(s) manufactured for or by Disston Company (hereinafter “Disston”). “Date of Original Retail Purchase” is the date the customer first bought the Product.

2. Scope of Warranty

DISSTON WARRANTS that its Products are free from defective materials and workmanship for a period of ONE (1) YEAR from the Date of Original Retail Purchase. This warranty does not extend to Products that have been damaged by accident, abuse, misuse, or misapplication; or to Products that have been modified or altered.

3. Warranty Procedures

Disston will, at its option, repair, replace or credit an amount equal to the purchase price of the Product in addition to any shipping paid by the customer, provided that the customer first contacts Disston’s customer service department for return authorization and instructions. Upon return authorization, the Product should be returned to Disston with shipping prepaid for review and evaluation. The contact information for Disston’s customer service department is as follows:

Disston Company
45 Plainfield Street
Chicopee, MA 01013
Phone: 800-272-4436 800-446-8890 International Phone: 413-523-1883
Fax: 800-654-1972 888-729-3004 International Fax: 413-523-1854
Email: customer.service@disstontools.com

Disston reserves the right to require reimbursement for shipping costs if the Product received by Disston is not covered by this warranty and the customer requests that the product be returned.

4. Limitations on Warranty

THE WARRANTY AND REMEDIES SET FORTH ABOVE ARE EXCLUSIVE AND IN LIEU OF ALL OTHERS, WHETHER ORAL OR WRITTEN, EXPRESSED OR IMPLIED. DISSTON COMPANY SPECIFICALLY DISCLAIMS ANY AND ALL IMPLIED WARRANTIES, INCLUDING, WITHOUT LIMITATION, WARRANTIES OF MERCHANTABILITY AND FITNESS FOR A PARTICULAR PURPOSE. NO DISSTON COMPANY REPRESENTATIVE, EMPLOYEE, DEALER, RESELLER, OR AGENT IS AUTHORIZED TO MAKE ANY MODIFICATION, EXTENSION OR ADDITION TO THIS WARRANTY. DISSTON IS NOT RESPONSIBLE FOR SPECIAL, INCIDENTAL OR CONSEQUENTIAL DAMAGES RESULTING FROM ANY BREACH OF WARRANTY, OR UNDER ANY OTHER LEGAL THEORY.

Some states do not allow the exclusion or limitation of incidental or consequential damages or exclusions of implied warranties, so the above limitations or exclusion may not apply to you. This warranty gives you specific legal rights, and you may also have other rights that vary from state to state.

Lead times may vary. Please contact your Sales Representative for more information.



DISSTON®

A Cut Above Since 1840

Disston Company
45 Plainfield Street
Chicopee, MA 01013
USA

Telephone: 1-800-272-4436
1-800-446-8890
Fax: 1-800-654-1972
1-888-729-3004

International Telephone: 413-523-1883
International Fax: 413-523-1854
Email: customer.service@disstontools.com
www.disstontools.com

Disston®, Aggressor®, BLU-MOL®, BLU-MOL Xtreme® and RemGrit® are registered trademarks of Disston Company in the United States and/or other countries. ©2014 Disston Company. All rights reserved. E2121226 Rev.9 07/14

WWW.DISSTONTOOLS.COM