



As Seen On:  
**DISASTER DECKS**



# INNOVATION IN BUILDING PRODUCTS



LED LIGHTING



WOOD RAILING SYSTEM



TEMPERED GLASS PANELS



COMMERCIAL RAILING

- Easy 1-2-3 Step Installation
- Patented Rail Lock System
- Premium Powder Coat Finish
- No Painting, Less Maintaining

- Meets and Exceeds Building Codes
- 3D Quoting Program
- Never Rust Aluminum
- 20 Year Warranty\*



*\*IMPORTANT: Regal 20 year component warranty invalid unless genuine Regal Ideas components / glass are used in the Regal railing system.*



regalideas.com



Toll Free: 1-800-819-4344  
Fax: 1-604-952-4291  
Email: sales@regalideas.com

# Regal ideas

	PAGE	
<b>ALUMINUM RAILING SYSTEM</b>		
TOP & BOTTOM RAILS	1	Tempered Glass
ALUMINUM PICKETS / DECORATIVE PICKETS	2	
TEMPERED GLASS PANELS	3	
LED LIGHTING	4	
ALUMINUM POSTS - 2 1/4" x 42" HIGH	5	LED Lighting
ALUMINUM POSTS - 4" x 42" HIGH	6	
<b>SPECIALTY RAILING SYSTEMS</b>		
CRYSTAL RAIL	7-8	Crystal Rail
36" HIGH RAILING	9	
60" HIGH WIND WALL/ POOL RAILING	10-11	
<b>FASTENERS &amp; ASSEMBLY PARTS</b>		
FASTENERS	12	36" Railing
ASSEMBLY PARTS	13-14	
<b>HAND/STAIR RAIL</b>		
HAND/STAIR RAIL SOLUTION (ADA COMPLIANT)	15-16	60" Railing
<b>WOOD RAILING SYSTEM</b>		
WOOD RAILING SYSTEM - ROUND/CURVED BALUSTERS	17	Fasteners
WOOD RAILING SYSTEM - USING 3/4" SQUARE REGAL PICKETS	18	
WOOD RAILING SYSTEM - COMPONENTS & GATES	19	Assembly Parts
WOOD RAILING SYSTEM - USING TEMPERED GLASS	20	
<b>QUICKSTEP STAIR SYSTEM</b>		
STRINGERS	21	Hand/Stair Rail
STAIR TREADS, RISERS, CONNECTOR	22	
<b>MERCHANDISING</b>		
DISPLAYS	23	Wood System
MERCHANDISERS	24	

42" Railing

Tempered Glass

LED Lighting

Crystal Rail

36" Railing

60" Railing

Fasteners

Assembly Parts

Hand/Stair Rail

Wood System

QuickStep

Merchandising

**Features:**

- Regal Aluminum Railing top and bottom rail for use with square pickets, wide pickets, decorative pickets and glass panels.
- For use with 36", 42" & 60" (wind wall/pool railing) Regal Aluminum Railing systems.
- Patented lock-in picket system allows pickets to be quickly installed without the use of fasteners and bottom rail support.
- Constructed of high strength aluminum alloys to meet or exceed national building codes.
- Premium UV powder coated finish provides maximum durability and low maintenance.
- Twenty year limited warranty on components and ten years on finish.

## Top & Bottom Rails

Code	Description	Qty	Price	
TBR6	<b>6' o/c Top &amp; Bottom Rails</b> • Actual length: 69"	1 set		
TBR8	<b>8' o/c Top &amp; Bottom Rails</b> • Actual length: 93"	1 set		
TBR10	<b>10' o/c Top &amp; Bottom Rails</b> • Actual length: 117"	1 set		
TBR12	<b>12' o/c Top &amp; Bottom Rails</b> • Actual length: 141"	1 set		

## Stair Hand Rails - For use where building code specifies graspability requirement

Code	Description	Qty	Price	
STBR-12	<b>12' o/c Stair Top &amp; Bottom Rails</b> • Use with UAB and/or in-line post • Actual length: 141"	1 set		
STBR-CS	<b>Continuous Stair Top Rail Connecting Splice</b> • Connecting splice to join 2 stair top rails for stair runs that exceed 12 ft • Fasteners sold separately • For use with in-line stair post (ILSP)	1 unit		
SHRC	<b>End Cap for Stair Top Rail</b> • Used to cap the ends of Regal Aluminum stair top rail (STBR stair handrail) • Fasteners sold separately	1 unit		

Available Colors: (OW) White, (BL) Black, (TP) Taupe, (YB)Yard Bronze, (TB) Textured Black

PRODUCTS MAY NOT BE EXACTLY AS ILLUSTRATED

42" Railing

Tempered Glass

LED Lighting

Crystal Rail

36" Railing

60" Railing

Fasteners

Assembly Parts

Hand/Stair Rail

Wood System

QuickStep

Merchandising

# Regal ideas

# ALUMINUM PICKETS

**Features:**

- Pickets for 42" High Regal Aluminum Railing system.
- Patented lock-in picket system allows pickets to be quickly installed in railing without the use of fasteners and bottom rail support.
- Constructed of high strength aluminum alloys to meet or exceed national building codes.
- Premium UV powder coated finish provides maximum durability and low maintenance.
- Twenty year limited warranty on components and ten years on finish.

**Pickets - for 42" High Regal Aluminum Railing**

Code	Description	Qty	Price
<b>SP6</b>	<b>Straight Pickets for 6' o/c</b> • ¾" pickets, Includes 30 aluminum 4" spacers	14/pkg	
<b>SP8</b>	<b>Straight Pickets for 8' o/c</b> • ¾" pickets, Includes 40 aluminum 4" spacers	19/pkg	
<b>SP10</b>	<b>Straight Pickets for 10' o/c</b> • ¾" pickets, Includes 50 aluminum 4" spacers	24/pkg	
<b>SPS6</b>	<b>Stair Straight Pickets for 6' o/c</b> • ¾" pickets, Includes 26 aluminum 5" spacers	12/pkg	
<b>WP3</b>	<b>Wide Pickets (covers 3ft with spacers)</b> • 1 ¼" pickets, Includes 14 aluminum 4" spacers	6/pkg	
<b>WPS3</b>	<b>Stair Wide Pickets (covers 3ft with spacers)</b> • 1 ¼" pickets, Includes 14 aluminum 5" spacers	6/pkg	

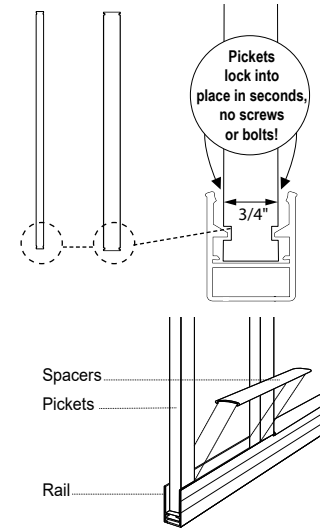

Available Colors: (0W) White, (BL) Black, (TP) Taupe, (YB)Yard Bronze, (TB) Textured Black

**Decorative Inserts & Pickets**

- Decorative Inserts and Pickets are an Ornamental Option for standard 42" high Regal Aluminum Railing

Code	Description	Qty	Price
<b>DC</b>	<b>Decorative Circle</b> • Ornamental option that fits in place of top spacer • Can be used with 42", 36" and 60" high railing with pickets	1 unit	
<b>DP-NR</b>	<b>Narrow Round Decorative Picket</b> • Ornamental option that fits in place of regular picket • For straight horizontal applications, not available for stairs. Compatible with 42" High Railing System only	1 unit	
<b>DP-WR</b>	<b>Wide Round Decorative Picket</b> • Ornamental option that fits in place of regular picket • For straight horizontal applications, not available for stairs. Compatible with 42" High Railing System only	1 unit	
<p><b>Mix and Match Regal Ideas Decorative Pickets with the 42" high Regal Aluminum Railing system to create a personalized railing</b></p>			

Available Colors: (0W) White, (BL) Black, (TP) Taupe, (YB)Yard Bronze, (TB) Textured Black

PRODUCTS MAY NOT BE EXACTLY AS ILLUSTRATED

42" Railing  
Tempered Glass  
LED Lighting  
Crystal Rail  
36" Railing  
60" Railing  
Fasteners  
Assembly Parts  
Hand/Stair Rail  
Wood System  
QuickStep  
Merchandising

\*Please refer to your local building codes for guidelines & limitations before installation. Regal warranty invalid unless genuine Regal Ideas components / glass are used.

# Regal ideas

# TEMPERED GLASS PANELS

**Features:**

- Regal Ideas tempered glass thickness is 1/4" to conform to code specifications in U.S. and Canada.
- Provides railing with an unobstructed view.
- Compliment your glass panels by incorporating Regal Ideas LED lighting system.

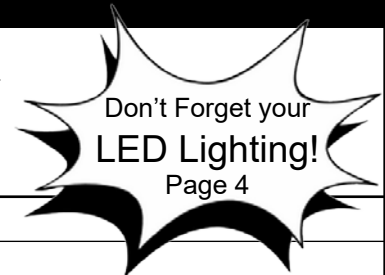

## Tempered Glass Panels 35 7/8" H x 1/4" T (6mm)

Tempered Glass  
 42" Railing  
 LED Lighting  
 Crystal Rail  
 36" Railing  
 60" Railing  
 Fasteners  
 Assembly Parts  
 Hand/Stair Rail  
 Wood System  
 QuickStep  
 Merchandising

Code	Description	Qty	Price
<b>Clear Glass Panel Sizes (Width):</b>			
CTG6	6" Tempered Glass Panel	1 panel	
CTG9	9" Tempered Glass Panel	1 panel	
CTG12	12" Tempered Glass Panel	1 panel	
CTG15	15" Tempered Glass Panel	1 panel	
CTG18	18" Tempered Glass Panel	1 panel	
CTG21	21" Tempered Glass Panel	1 panel	
CTG24	24" Tempered Glass Panel	1 panel	
CTG27	27" Tempered Glass Panel	1 panel	
CTG30	30" Tempered Glass Panel	1 panel	
CTG33	33" Tempered Glass Panel	1 panel	
CTG36	36" Tempered Glass Panel	1 panel	
CTG39	39" Tempered Glass Panel	1 panel	
CTG42	42" Tempered Glass Panel	1 panel	
CTG45	45" Tempered Glass Panel	1 panel	
CTG48	48" Tempered Glass Panel	1 panel	
CTG51	51" Tempered Glass Panel	1 panel	
CTG54	54" Tempered Glass Panel	1 panel	
CTG57	57" Tempered Glass Panel	1 panel	
CTG60	60" Tempered Glass Panel	1 panel	
CTG63	63" Tempered Glass Panel	1 panel	
CTG66	66" Tempered Glass Panel	1 panel	
CDG-6	<b>Horizontal 7 1/4" Glass Panels</b> • For 6' railing section • c/w spacers and glass gaskets that are LED compatible	6/pkg	
CAG-6	<b>Stair Angled 6" Glass Panels</b> • For 6' stair section - c/w 7 sets of spacer inserts and glass gaskets that are LED compatible • Designed for 35 degree stairs (+/- 2 degrees)	6/pkg	

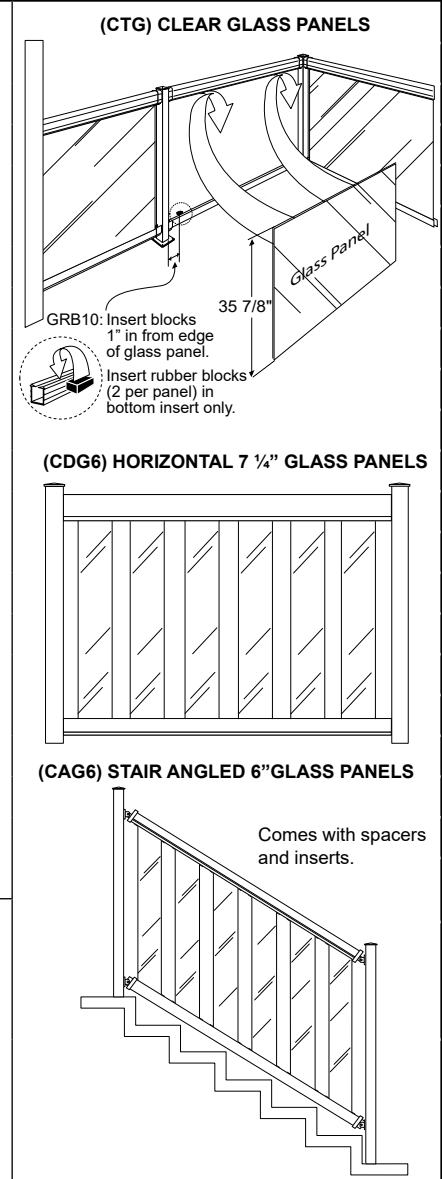

## Glass Panel Components (Required for glass installation)

Code	Description	Qty	Price
GVIL	<b>Vinyl Insert for Tempered Glass</b> • For 6' o/c sections	1 set	
GRB-10	<b>Rubber Blocks</b> • 2 blocks required per glass panel • Insert blocks 1" in from edge of glass panel	10/pkg	

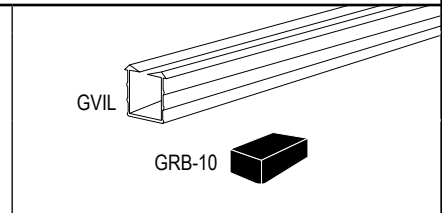

PRODUCTS MAY NOT BE EXACTLY AS ILLUSTRATED

# Regal ideas

# LED LIGHTING SYSTEM

**Features:**

- Exterior moisture resistant, low voltage remote controlled LED lighting system for use in Regal Aluminum Railing system.
- LED lighting is UL/CSA certified.
- For use with 36", 42" and 60" picket and tempered glass systems.
- Remote control unit provides 3 color and 3 brightness settings (White, Gold, Blue).
- Each power adapter can run up to 60ft (10 strips) of LED lighting strips.
- One year warranty.



Code	Description	Qty	Price		
<b>LED-C</b>	<p><b>LED Lighting Control Pack</b></p> <ul style="list-style-type: none"> <li>• Compact size low voltage LED control unit for easy placement inside Regal Aluminum Railing posts</li> <li>• Compact RF remote control unit</li> <li>• Includes 20ft power cord</li> <li>• Remote control unit provides 3 color and 3 brightness settings</li> </ul> <p><i>Note: One Power Supply will run a maximum of 10 LED strips (approx 60ft.)</i></p>	1 kit			42" Railing
<b>LED-L</b>	<p><b>LED Lighting Strips - 78" (2m)</b></p> <ul style="list-style-type: none"> <li>• 78" encapsulated LED strips for 6' railing sections (pickets and/or glass)</li> <li>• 120 LED lights per section</li> </ul>	1 unit			Tempered Glass
<b>LED-P</b>	<p><b>LED Clear Spacers -For Picket System</b></p> <ul style="list-style-type: none"> <li>• 15 clear spacers for lighting 6' picket railing section</li> </ul>	15/pkg			LED Lighting
<b>LED-SP</b>	<p><b>LED Clear Stair Spacers -For Stair Picket System</b></p> <ul style="list-style-type: none"> <li>• 13 clear spacers for lighting 6' picket stair railing section</li> </ul>	13/pkg			Crystal Rail
<b>LED-G</b>	<p><b>LED Glass Gasket - 6' o/c</b></p> <p><i>-For Glass Panel System</i></p> <ul style="list-style-type: none"> <li>• 6' o/c glass gasket for lighting 6' glass railing section (actual length: 69")</li> </ul>	1 set			36" Railing
<b>LED-T</b>	<p><b>LED Splitter Cord</b></p> <ul style="list-style-type: none"> <li>• Used to run LED lighting in 2 directions using the same power supply</li> </ul>	1 unit			60" Railing
<b>LED-PC</b>	<p><b>LED Patch Cord</b></p> <ul style="list-style-type: none"> <li>• 13ft Patch Cord used to connect LED strips when railing is not continuous. (eg. for stairway opening)</li> </ul>	1 unit			Fasteners

PRODUCTS MAY NOT BE EXACTLY AS ILLUSTRATED

\*Please refer to your local building codes for guidelines & limitations before installation. Regal warranty invalid unless genuine Regal Ideas components / glass are used.

# Regal ideas

# 42" HIGH POSTS

**Features:**

- Posts for 42" High Regal Aluminum Railing.
- Posts are 2 1/4" square complete with post cap, welded rail sleeves and attached 4" square aluminum base plate that is ACQ corrosion-resistant.
- Constructed of high strength aluminum alloys to meet or exceed national building codes.
- Premium UV powder coated finish provides maximum durability and low maintenance.
- Twenty year limited warranty on components and ten years on finish.

## 2 1/4" Posts - 42" High

Code	Description	Qty	Price	
<b>RCP</b>	<b>Corner Post</b> (2 1/4" x 2 1/4" x 42"H) • Welded brackets at 90° to connect rails to posts	1 unit		<p>RCP REP RLP RSP</p>
<b>REP</b>	<b>End Post</b> (2 1/4" x 2 1/4" x 42"H) • Welded brackets to connect rails to posts	1 unit		
<b>RLP</b>	<b>Line Post</b> (2 1/4" x 2 1/4" x 42"H) • Welded brackets to connect rails to posts	1 unit		
<b>RSP</b>	<b>Stair Post</b> (2 1/4" x 2 1/4" x 42"H) • For use with angle bracket or post bracket in stair, angle or custom applications	1 unit		
<i>Note: Fasteners sold separately</i>				
<b>RP45</b>	<b>45° Angle Post</b> (2 1/4" x 2 1/4" x 42"H) • Welded brackets connect rails to posts at 45° angle	1 unit		<p>RP45 ILSP</p>
<b>ILSP</b>	<b>In-Line Stair Post</b> (2 1/4" x 2 1/4" x 36"H) • Undermount post to attach Top rail between top and bottom of stairs • Includes bottom UAB bracket	1 unit		
<i>Note: Fasteners sold separately</i>				

## Base Plate Cover - for 2 1/4" Regal Aluminum Posts

Code	Description	Qty	Price	
<b>BC</b>	<b>2 1/4" Post Base Plate Cover</b> • Two piece cast aluminum base plate cover • Wraps post base to hide fasteners and provide a finished appearance	1 unit		

## Decorative Post Caps - for 2 1/4" Regal Aluminum Posts

Code	Description	Qty	Price	
<b>DPC-B</b>	<b>Ball Post Cap</b>	1 unit		<p>DPC-B DPC-P DPC-T</p>
<b>DPC-P</b>	<b>Pyramid Post Cap</b>	1 unit		
<b>DPC-T</b>	<b>Tower Post Cap</b> • Snap on aluminum cap to replace standard cap	1 unit		

Available Colors: (0W) White, (BL) Black, (TP) Taupe, (YB)Yard Bronze, (TB) Textured Black

PRODUCTS MAY NOT BE EXACTLY AS ILLUSTRATED

42" Railing  
Tempered Glass  
LED Lighting  
Crystal Rail  
36" Railing  
60" Railing  
Fasteners  
Assembly Parts  
Hand/Stair Rail  
Wood System  
QuickStep  
Merchandising





# Regal ideas

# 4" ALUMINUM POSTS

**Features:**

- Posts for 42" High Regal Aluminum Railing.
- Complete with post cap, welded rail sleeves and attached 6" square aluminum base plate that is ACQ corrosion-resistant.
- Constructed of high strength aluminum alloys to meet or exceed national building codes.
- Premium UV powder coated finish provides maximum durability and low maintenance.
- Twenty year limited warranty on components and ten years on finish.

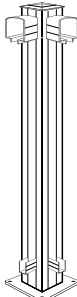
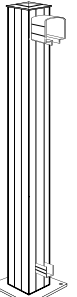
## 4" Posts - 42" High

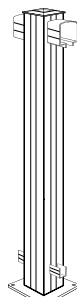
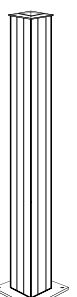
Code	Description	Qty	Price		
<b>RP4C</b>	<b>4" Corner Post</b> (4" x 4" x 42" Height)  • Welded brackets at 90° to connect rails to posts	1 unit			
<b>RP4E</b>	<b>4" End Post</b> (4" x 4" x 42" Height)  • Welded brackets to connect rails to posts	1 unit			
<b>RP4L</b>	<b>4" Line Post</b> (4" x 4" x 42" Height)  • Welded brackets to connect rails to posts	1 unit			
<b>RP4S</b>	<b>4" Stair Post</b> (4" x 4" x 42" Height)  • For use with angle bracket or post bracket in stair, angle or custom applications  <i>Note: Fasteners sold separately</i>	1 unit			

## Base Plate Cover - for 4" Regal Aluminum Posts

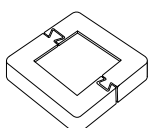
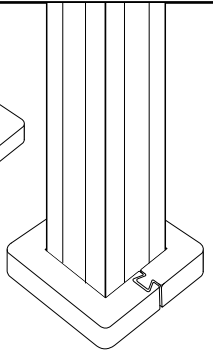
Code	Description	Qty	Price		
<b>BC4</b>	<b>4" Post Base Plate Cover</b>  • Two piece cast aluminum base plate cover • Wraps post base to hide fasteners and provide a more finished appearance	1 unit			

Available Colors: (0W) White, (BL) Black, (TP) Taupe, (YB)Yard Bronze, (TB) Textured Black

PRODUCTS MAY NOT BE EXACTLY AS ILLUSTRATED

42" Railing

Tempered Glass

LED Lighting

Crystal Rail

36" Railing

60" Railing

Fasteners

Assembly Parts

Hand/Stair Rail

Wood System

QuickStep

Merchandising



**Features:**

- The stunning clarity of Regal Ideas White No Iron Tempered Glass panels make it the obvious choice for homeowners that want an unobstructed view. Conforms to code specifications in U.S. and Canada.
- Tempered Glass contains no iron which produces a crystal clear glass panel with clarity like you have never seen before.
- Glass Mounting brackets include pre-installed LED's that can light up your glass panels at night.
- White No Iron Tempered Glass Stair Panels are also available. For Hand/Stair rail options see page 15.

## Crystal Rail Horizontal & Stair Glass Mounts

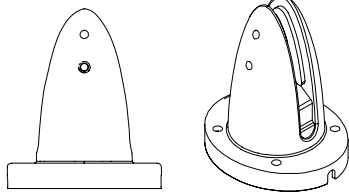
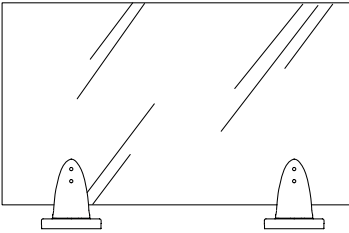
Code	Description	Qty	Price	
<b>CRH</b>	<b>Horizontal Glass Mount with LED</b> <ul style="list-style-type: none"> <li>• To hold No Iron tempered glass panels (CRG)</li> <li>• c/w internal leveling angle adjustments</li> <li>• c/w white LED light inside mount</li> </ul>	1 unit		
<b>CRHS</b>	<b>Stair Horizontal Glass Mount</b> <ul style="list-style-type: none"> <li>• To hold No Iron tempered glass panels (CRSG) on stairs</li> <li>• c/w internal leveling angle adjustments</li> <li>• c/w white LED light inside mount</li> </ul> <p>Color: Satin Aluminum</p> <p><b>IMPORTANT:</b> Must be fastened using mounting plates and bolts found on page 12</p> <p>Driver Kit and additional components required to operate LED (see next page)</p>	1 unit		

## White No Iron Tempered Glass Panels - 3/8" (10mm) Thickness

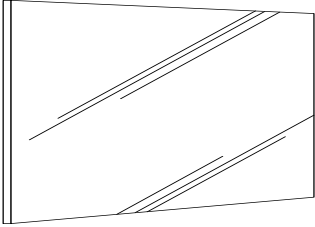
Code	Description	Qty	Price	
<b>CRG24</b>	<b>24" x 40" H White No Iron Clear Panel</b>	1 panel		
<b>CRG30</b>	<b>30" x 40" H White No Iron Clear Panel</b>	1 panel		
<b>CRG36</b>	<b>36" x 40" H White No Iron Clear Panel</b>	1 panel		
<b>CRG42</b>	<b>42" x 40" H White No Iron Clear Panel</b>	1 panel		
<b>CRG48</b>	<b>48" x 40" H White No Iron Clear Panel</b>	1 panel		
<b>CRG54</b>	<b>54" x 40" H White No Iron Clear Panel</b>	1 panel		
<b>CRG60</b>	<b>60" x 40" H White No Iron Clear Panel</b>	1 panel		

## White No Iron Tempered for 35° Stair Glass Panels (Note: for use on 35° angle)

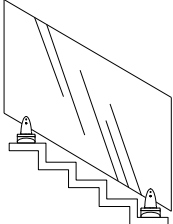
Code	Description	Qty	Price	
<b>CRSG03</b>	<b>10mm Angled glass for 3 steps (29 1/2" Width)</b>	1 panel		
<b>CRSG04</b>	<b>10mm Angled glass for 4 steps (40" Width)</b>	1 panel		
<b>CRSG05</b>	<b>10mm Angled glass for 5 steps (50 1/2" Width)</b>	1 panel		

**HAND RAIL OPTIONS FOR CRYSTAL RAIL - see page 15**

PRODUCTS MAY NOT BE EXACTLY AS ILLUSTRATED

42" Railing

Tempered Glass

LED Lighting

Crystal Rail

36" Railing

60" Railing

Fasteners

Assembly Parts

Hand/Stair Rail

Wood System

QuickStep

Merchandising

**White No Iron Tempered Glass for Pool Rail/Wind Wall Applications**

Code	Description	Qty	Price	
<b>CRG48</b>	<b>48" x 40" White No Iron Tempered Glass</b> • Can be installed on end to achieve 50" height when 48" (min) is required	1 panel		
<b>CRG60</b>	<b>60" x 40" White No Iron Tempered Glass</b> • Can be installed on end to achieve 62" height when 60" (min) is required	1 panel		
<b>NOTE: Wind Wall/Pool Railing designed for ground level applications only</b>				

42" Railing

Tempered Glass

LED Lighting

**Crystal Rail Gate Parts**

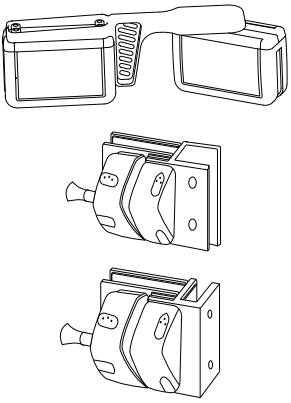
Code	Description	Qty	Price	
<b>CRGH</b>	<b>Gate Hinge Set</b> • Durable hinge set used to hold the Crystal Rail Glass panel for the gate	1 pair		
<b>CRIL</b>	<b>Magnetic In-line Gate Latch</b> • Adjustable magnetic in-line latching system • For use in horizontal in-line gates	1 unit		
<b>CRCL</b>	<b>Magnetic Corner Gate Latch</b> • Adjustable magnetic corner gate latching system • For use in 90° corner gates  Note: • For gates, use glass size up to max 42" • Pool applications require self closing hinges	1 unit		

Crystal Rail

36" Railing

60" Railing

Fasteners

**LED Controller and Components**

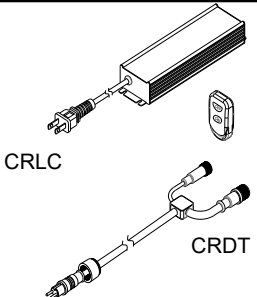
Code	Description	Qty	Price	
<b>CRLC</b>	<b>LED Controller</b> • For use with Crystal Rail glass mounts • Max 40 glass mounts per controller • Includes Remote Control	1 unit		
<b>CRDT</b>	<b>Double-T Splitter Connection Cord</b> • 39" (1 meter) cord • To connect LED to each Glass Mount	1 unit		

Assembly Parts

Hand/Stair Rail

Wood System

**Vacuum Cup**

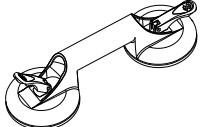
Code	Description	Qty	Price	
<b>CVC</b>	<b>Vacuum Cup</b> • Vacuum tool for easier moving and handling of 3/8" (10mm) glass panels (2 required)	1 unit		

QuickStep

Merchandising

HAND RAIL OPTIONS FOR CRYSTAL RAIL - see page 15 | FASTENERS - see page 12

PRODUCTS MAY NOT BE EXACTLY AS ILLUSTRATED

\*Please refer to your local building codes for guidelines & limitations before installation. Regal warranty invalid unless genuine Regal Ideas components / glass are used.

# Regal ideas

# 36" HIGH RAILING

**Features:**

- 36" High Regal Aluminum Railing is available using standard 3/4" pickets only. Tempered Glass and Decorative Pickets not available.
- Posts are 2 1/4" square complete with post cap, welded rail sleeves and attached 4" square aluminum base plate that is ACQ corrosion-resistant.
- Constructed of high strength aluminum and premium UV powder coated finish provides maximum durability and low maintenance.
- Twenty year limited warranty on components and ten years on finish.

## 2 1/4" Posts - 36" High

Code	Description	Qty	Price	
RCP36	<b>36" High Corner Post</b> (2 1/4" x 2 1/4" x 36" H)	1 unit		
REP36	<b>36" High End Post</b> (2 1/4" x 2 1/4" x 36" H)	1 unit		
RLP36	<b>36" High Line Post</b> (2 1/4" x 2 1/4" x 36" H)	1 unit		
RSP36	<b>36" High Stair Post</b> (2 1/4" x 2 1/4" x 36" H) <i>Note: Fasteners sold separately</i>	1 unit		

## Base Plate Cover - for 2 1/4" Regal Aluminum Posts

Code	Description	Qty	Price	
BC	<b>2 1/4" Post Base Plate Cover</b> <ul style="list-style-type: none"> <li>• Two piece cast aluminum base plate cover</li> <li>• Wraps post base to hide fasteners and provide a more finished appearance</li> </ul>	1 unit		

## Decorative Post Caps - for 2 1/4" Regal Aluminum Posts

Code	Description	Qty	Price	
DPC-B	<b>Ball Post Cap</b>	1 unit		
DPC-P	<b>Pyramid Post Cap</b>	1 unit		
DPC-T	<b>Tower Post Cap</b>	1 unit		

## Top & Bottom Rails (Same Top & Bottom Rails used in the 42" High Railing System)

Code	Description	Qty	Price	
TBR6	<b>6' o/c Top &amp; Bottom Rails</b> (Actual length: 69")	1 set		
TBR8	<b>8' o/c Top &amp; Bottom Rails</b> (Actual length: 93")	1 set		
TBR10	<b>10' o/c Top &amp; Bottom Rails</b> (Actual length: 117")	1 set		
TBR12	<b>12' o/c Top &amp; Bottom Rails</b> (Actual length: 141")	1 set		

*Note: Fasteners sold separately*

## 36" High Pickets & Gates

Code	Description	Qty	Price	
SP36-6	<b>Straight Pickets for 6' o/c section</b> <ul style="list-style-type: none"> <li>• 3/4" pickets, Includes 30 aluminum 4" spacers</li> <li>• Pickets lock into place, no screws or bolts needed</li> </ul>	14/pkg		
SPS6	<b>Stair Straight Pickets for 6' o/c section</b> <ul style="list-style-type: none"> <li>• 3/4" pickets, Includes 26 aluminum 5" spacers</li> </ul>	12/pkg		
ASGP36	<b>36"H x 48"W Gate Package</b> <ul style="list-style-type: none"> <li>• Straight 3/4" pickets</li> <li>• Fits openings up to 48"</li> </ul>	1 pkg		

Available Colors: (OW) White, (BL) Black, (TB) Textured Black

PRODUCTS MAY NOT BE EXACTLY AS ILLUSTRATED

42" Railing  
Tempered Glass  
LED Lighting  
Crystal Rail  
36" Railing  
60" Railing  
Fasteners  
Assembly Parts  
Hand/Stair Rail  
Wood System  
QuickStep  
Merchandising

# Regal ideas

# 60" HIGH WIND WALL/POOL RAILING

**Features:**

- 60" High Regal Aluminum Railing, works with Regal rails, post caps, wall and universal angle brackets.
- Posts are 2 1/4" square complete with post cap, welded rail sleeves and attached 4" square aluminum base plate that is ACQ corrosion-resistant.
- Constructed of high strength aluminum alloys and premium UV powder coated finish.
- Twenty year limited warranty on components and ten years on finish.

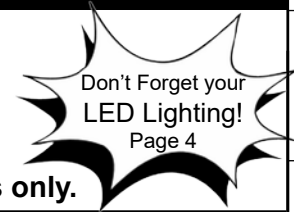

**IMPORTANT: Wind Wall/Pool Railing designed for ground level applications only.**

## 2 1/4" Posts - 60" High

Code	Description	Qty	Price	
<b>WRCP</b>	<b>Wind Wall Corner Post</b> (2 1/4" x 2 1/4" x 60" H) • Welded brackets at 90° to connect rails to posts	1 unit		<p>WRCP      WREP      WRLP</p>
<b>WREP</b>	<b>Wind Wall End Post</b> (2 1/4" x 2 1/4" x 60" H) • Welded brackets to connect rails to posts	1 unit		
<b>WRLP</b>	<b>Wind Wall Line Post</b> (2 1/4" x 2 1/4" x 60" H) • Welded brackets to connect rails to posts  <i>Note: Fasteners sold separately</i>	1 unit		

## Base Plate Cover - for 2 1/4" Regal Aluminum Posts

Code	Description	Qty	Price	
<b>BC</b>	<b>2 1/4" Post Base Plate Cover</b> • Two piece cast aluminum base plate cover • Wraps post base to hide fasteners and provide a more finished appearance	1 unit		

## Decorative Post Caps - for 2 1/4" Regal Aluminum Posts

Code	Description	Qty	Price	
<b>DPC-B</b>	<b>Ball Post Cap</b>	1 unit		<p>DPC-B      DPC-P      DPC-T</p>
<b>DPC-P</b>	<b>Pyramid Post Cap</b>	1 unit		
<b>DPC-T</b>	<b>Tower Post Cap</b> • Snap on aluminum cap to replace standard cap	1 unit		

## Top & Bottom Rails (Same Top & Bottom Rails used in the 42" High Riling System)

Code	Description	Qty	Price	
<b>TBR6</b>	<b>6' o/c Top &amp; Bottom Rails</b> (Actual length: 69")	1 set		
<b>TBR8</b>	<b>8' o/c Top &amp; Bottom Rails</b> (Actual length: 93")	1 set		
<b>TBR10</b>	<b>10' o/c Top &amp; Bottom Rails</b> (Actual length: 117")	1 set		
<b>TBR12</b>	<b>12' o/c Top &amp; Bottom Rails</b> (Actual length: 141")	1 set		

Available Colors: (0W) White, (BL) Black

PRODUCTS MAY NOT BE EXACTLY AS ILLUSTRATED

42" Railing  
Tempered Glass  
LED Lighting  
Crystal Rail  
36" Railing  
60" Railing  
Fasteners  
Assembly Parts  
Hand/Stair Rail  
Wood System  
QuickStep  
Merchandising

# Regal ideas

# 60" HIGH WIND WALL/POOL RAILING

## 60" High Gates and Pickets

Code	Description	Qty	Price	
WSP60-6	<b>60" High Straight Pickets for 6' o/c</b> <ul style="list-style-type: none"> <li>• 3/4" pickets, Includes 30 aluminum 4" spacers</li> <li>• Pickets lock into place, no screws or bolts needed</li> </ul>	1 pkg		
WPG60	<b>60" High Gate Package</b> <ul style="list-style-type: none"> <li>• c/w Rails, hinge post, latch post, 8 pickets 3/4" square with spacers, hinges and latch</li> <li>• Fits openings up to 48"</li> <li>• Fasteners sold separately</li> </ul> <p>Note:</p> <ul style="list-style-type: none"> <li>• Pool applications require self closing hinges</li> </ul>	1 pkg		

## Glass for Wind Wall/Pool Railing

Code	Description	Qty	Price	
CTWG-31	<b>3ft o/c Wind Wall/Pool Railing Glass</b> <ul style="list-style-type: none"> <li>• 31" x 53 7/8" x 1/4" (6mm)</li> </ul>	1 panel		
CTWG-43	<b>4ft o/c Wind Wall/Pool Railing Glass</b> <ul style="list-style-type: none"> <li>• 43 x 53 7/8" x 1/4" (6mm)</li> </ul> <p>Note: Requires glass gasket and rubber blocks for installation</p>	1 panel		

## Wind Wall/Pool Railing Components (Required for glass installation)

Code	Description	Qty	Price	
GVIL	<b>Vinyl Insert for Tempered Glass</b> <ul style="list-style-type: none"> <li>• For 6' o/c sections</li> </ul>	1 set		
GRB-10	<b>Rubber Blocks</b> <ul style="list-style-type: none"> <li>• 2 blocks required per glass panel</li> </ul>	10/pkg		

Available Colors: (0W) White, (BL) Black

PRODUCTS MAY NOT BE EXACTLY AS ILLUSTRATED







42" Railing  
Tempered Glass  
LED Lighting  
Crystal Rail  
36" Railing  
60" Railing  
Fasteners  
Assembly Parts  
Hand/Stair Rail  
Wood System  
QuickStep  
Merchandising

# Regal ideas

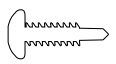
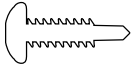
# FASTENERS

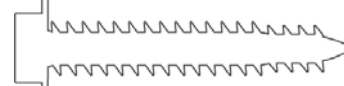
**Features:**

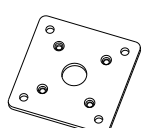
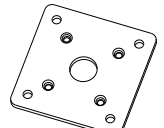
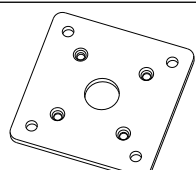
- High strength fasteners and mounting plates for installing the various Regal ideas railing components.
- Never compromise on using the right fasteners for your project.
- Contact our Customer Service department for fastening drawings and requirements for your region.
- **IMPORTANT:** Please refer to your local building codes for guidelines and limitations.

Code	Description	Qty	Price		
<b>WCS-50</b>	<b>#10 x 3/4" Self Drilling Screws</b> • For metal connections • Available in all standard colors	50/pkg			42" Railing
<b>S114</b>	<b>#10 x 1 1/4" Self Drilling Screw</b> • To attach QuickStep stair treads to QuickStep stair stringers	24/pkg			Tempered Glass
<b>SCP-24</b>	<b>#14 x 2 1/2" Lag Screws</b> • Used with posts and wall brackets • Available in all standard colors	24/pkg			LED Lighting
<b>PML6</b>	<b>3/8" x 6" Lag Screws</b> (Used with Posts*) • Hot dipped galvanized	4/pkg			Crystal Rail
<b>MB3</b>	<b>3/8" x 2 3/4" Structural Bolt c/w nut</b> • For use with MP4, MP5 and MP6 mounting plate to stair treads • Hot dipped galvanized	24/pkg			36" Railing
<b>MB6</b>	<b>3/8" x 6" Structural Bolt</b> • For use with MP4, MP5 and MP6 mounting plates. • Hot dipped galvanized	4/pkg			60" Railing
<b>MP4</b>	<b>4" Aluminum Bolt-Through Mounting Plate</b> • For 2 1/4" post (under or side mount) • Mill finish aluminum	1 unit			Fasteners
<b>MP5</b>	<b>5" Aluminum Bolt-Through Mounting Plate</b> • For Crystal Rail (under or sidemount) • Mill finish aluminum	1 unit			Assembly Parts
<b>MP6</b>	<b>6" Aluminum Bolt-Through Mounting Plate</b> • For 4" Posts • Mill finish aluminum	1 unit			Hand/Stair Rail
<b>MBC</b>	<b>4" SS Concrete Anchors</b> • For concrete surface applications • Stainless Steel	4/pkg			Wood System

**\*IMPORTANT:** Please refer to your local Building Codes for guidelines on post installations for above ground decks.

PRODUCTS MAY NOT BE EXACTLY AS ILLUSTRATED

# Regal ideas

# ASSEMBLY PARTS

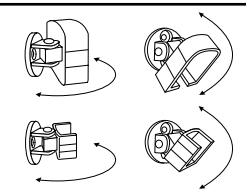
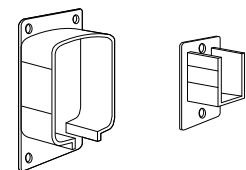
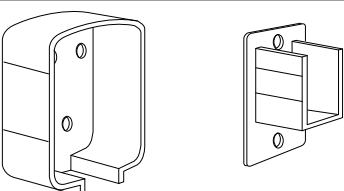
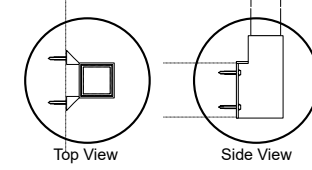
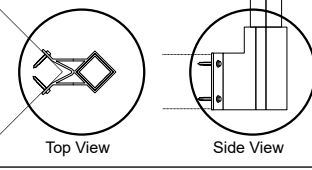
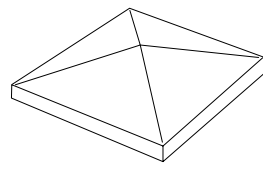
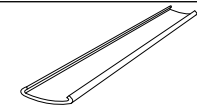
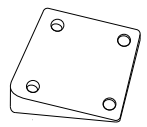
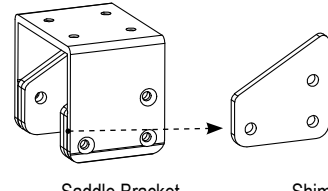
Code	Description	Qty	Price		
<b>UAB</b>	<b>Universal Angle Bracket</b> <ul style="list-style-type: none"> <li>To accommodate stairs and angles</li> <li>Fasteners sold separately</li> </ul>	1 set		 <p>Set includes one Top and one Bottom bracket</p>	42" Railing Tempered Glass
<b>WB</b>	<b>Top &amp; Bottom Wall Brackets</b> <ul style="list-style-type: none"> <li>For attaching Regal Aluminum Railing top and bottom rails to an existing structure</li> <li>Fasteners sold separately</li> </ul>	1 set			LED Lighting
<b>PB</b>	<b>Top &amp; Bottom Post Brackets</b> <ul style="list-style-type: none"> <li>Top and bottom rail brackets for custom posts or multi-level applications</li> <li>Fasteners sold separately</li> </ul>	1 set			Crystal Rail
<b>PSB</b>	<b>Sidemount Post Bracket</b> <ul style="list-style-type: none"> <li>Fascia mount bracket for End Post, Line Post, Stair Post or Inside Corner Post</li> <li>Fasteners sold separately</li> </ul>	1 unit		 <p>Top View Side View</p>	36" Railing
<b>PSCB</b>	<b>Sidemount Corner Post Bracket</b> <ul style="list-style-type: none"> <li>For Outside Corner fascia applications</li> <li>Fasteners sold separately</li> </ul>	1 unit		 <p>Top View Side View</p>	60" Railing Fasteners
<b>PC</b>	<b>Standard Replacement Post Cap</b> <ul style="list-style-type: none"> <li>Standard replacement post cap for Regal Aluminum Railing 2-1/4" posts</li> </ul>	1 unit			Assembly Parts
<b>RS4-6</b>	<b>4" Spacers</b> <ul style="list-style-type: none"> <li>4" railing spacers (6/pack)</li> </ul>	6/pkg			Hand/Stair Rail
<b>PBW</b>	<b>Post Leveling Wedge</b> <ul style="list-style-type: none"> <li>Post Leveling Wedged Shim for 1:12 Slope</li> </ul>	1 unit			Wood System
<b>PSSB</b>	<b>Stair Saddle Bracket</b> <ul style="list-style-type: none"> <li>Bracket replaces regular base plate on a 2 1/4" stair post so that it can be mounted to the top of a wood stringer</li> <li>c/w 4 base plate screws, shims included</li> <li>Accepts wood stringer thickness of 2.5" - 3.5"</li> <li>Colors: White, Black, Yard Bronze</li> </ul>	1 unit		 <p>Saddle Bracket Shims</p>	QuickStep Merchandising

Available Colors: (0W) White, (BL) Black, (TP) Taupe, (YB)Yard Bronze, (TB) Textured Black

PRODUCTS MAY NOT BE EXACTLY AS ILLUSTRATED

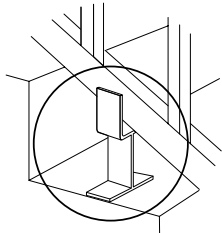
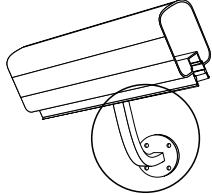
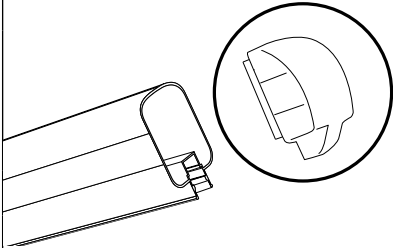
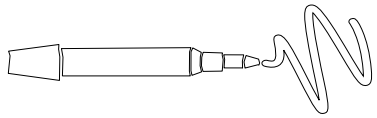
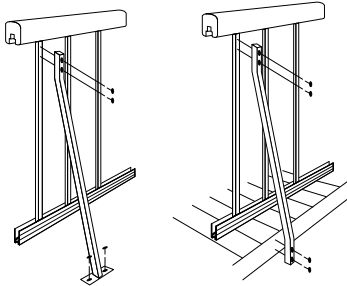
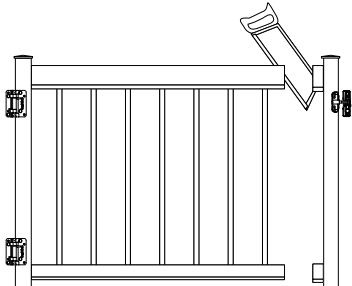
Code	Description	Qty	Price		
<b>SRSL</b>	<b>Stair Rail Support Leg</b> <ul style="list-style-type: none"> <li>For stair runs over 4ft</li> <li>For horizontal bottom rail support if required</li> <li>For glass panels 48" W and larger</li> <li>Fasteners sold separately</li> </ul>	1 unit			42" Railing Tempered Glass
<b>HRB</b>	<b>Hand Rail Bracket</b> <ul style="list-style-type: none"> <li>Used to attach top rail or stair top rail (graspable) to wall or post</li> <li>Fasteners sold separately</li> </ul>	1 unit			LED Lighting Crystal Rail
<b>HRC</b>	<b>Hand Rail Cap</b> <ul style="list-style-type: none"> <li>End cap for stair rails (For use with TBR Rails)</li> <li>Fasteners sold separately</li> </ul>	1 unit			36" Railing
<b>TUP</b>	<b>Touch-Up Pen</b> <ul style="list-style-type: none"> <li>Touch-Up paint pen to match Regal Aluminum Railing colors</li> <li>Pen holds 10 ml of color matched paint and includes extra tip</li> </ul>	1 unit			60" Railing Fasteners
<b>ISRB</b>	<b>Inside Railing Brace</b> <ul style="list-style-type: none"> <li>Complete with fasteners for mounting on pickets or posts</li> </ul>	1 unit			Assembly Parts
<b>OSRB</b>	<b>Outside Railing Brace</b> <ul style="list-style-type: none"> <li>Complete with fasteners for mounting on pickets or posts</li> </ul>	1 unit			
<b>ASGP</b>	<b>42"H x 48"W Gate Package (Straight 3/4" Pickets)</b> <ul style="list-style-type: none"> <li>Fits openings up to 48"</li> <li>Fasteners sold separately</li> </ul>	1 pkg			Wood System
<b>WGP</b>	<b>42"H x 48"W Gate Package (Wide 1 1/16" Pickets)</b> <ul style="list-style-type: none"> <li>Fits openings up to 48"</li> <li>Fasteners sold separately</li> </ul> <p><b>GATE PACKAGE INCLUDES:</b> Rails, hinge post, latch post, pickets with spacers, hinges and latch</p>	1 pkg			QuickStep

Available Colors: (OW) White, (BL) Black, (TP) Taupe, (YB)Yard Bronze, (TB) Textured Black

PRODUCTS MAY NOT BE EXACTLY AS ILLUSTRATED



# Regal ideas

# HAND/STAIR RAIL

**Features:**

- Regal ideas offers a complete aluminum Hand/Stair rail solution (ADA Compliant).
- Easy to install and conforms to code specifications in the U.S. and Canada.
- Provides added safety and security to any stair or ramp.
- Used as hand rail/stair rail for Crystal Rail system.

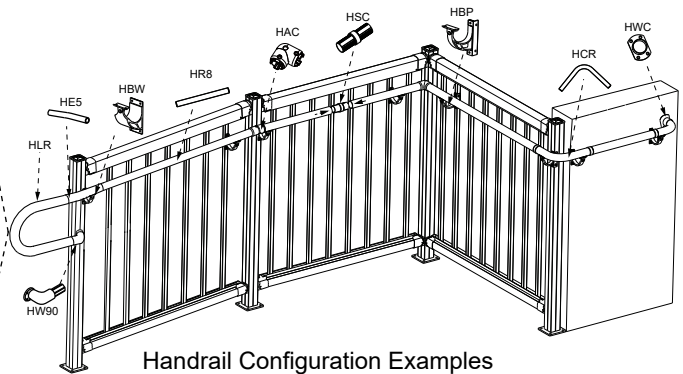
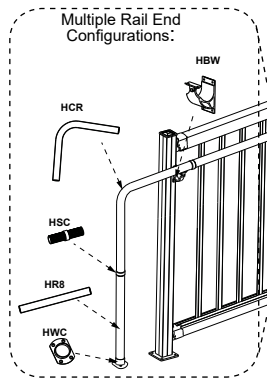

## Hand/Stair Rail Components

Code	Description	Qty	Price	
HR8	<b>8ft Hand/Stair Rail</b> • 1 1/2" OD Hand/Stair rail	1 unit		
HCR	<b>90° Corner/Return Rail Section</b> • To accommodate 90° corner or ground return • A picket or post bracket must be used at each seam of rail to rail connections when used as a corner	1 unit		
HW90	<b>90° Wall Return</b> • To accommodate 90° return into wall or post	1 unit		
HLR	<b>Handrail Loop Return</b> • 180° return to finish handrail system • A wall return is used one end to attach to post of wall • 35° elbow required for stairs, 5° elbow required for ramps	1 unit		
HE35	<b>35° Elbow</b> • Connects 180° handrail return to hand/stair rail on stair applications	1 unit		
HE5	<b>5° Elbow</b> • Connects 180° handrail return to handrail on ramp applications	1 unit		

Available Color: Satin Aluminum

PRODUCTS MAY NOT BE EXACTLY AS ILLUSTRATED

42" Railing

Tempered Glass

LED Railing

Crystal Rail

36" Railing

60" Railing

Fasteners

Assembly Parts

Hand/Stair Rail

Wood System

QuickStep

Merchandising

# Regal ideas

# HAND/STAIR RAIL

## Hand/Stair Rail Components

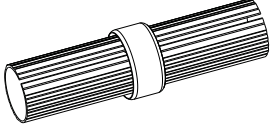
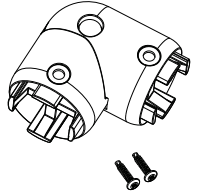
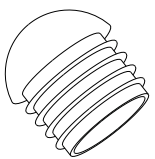
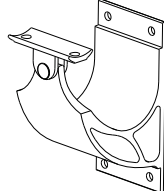
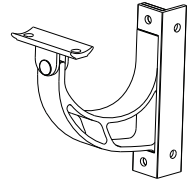
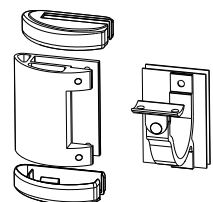
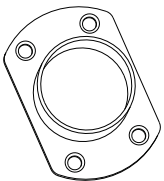
Code	Description	Qty	Price		
<b>HSC</b>	<b>Rail Splice and Cap</b> • 10" splice to connect sections of hand/stair rail	1 unit			42" Railing
<b>HAC</b>	<b>Adjustable Angle Connector</b> • Accommodates any corner or angle connection • Includes 2 mounting screws	1 unit			Tempered Glass LED Railing
<b>HEC</b>	<b>End Rail Cap</b> • End cap for rails	1 unit			Crystal Rail 36" Railing
<b>HBW</b>	<b>Wall/Post Bracket</b> • To attach handrail to wall or post	1 unit			60" Railing
<b>HBP</b>	<b>Picket Bracket</b> • To attach handrail to railing picket	1 unit			Fasteners Assembly Parts
<b>HBG</b>	<b>10mm Glass Bracket</b> • To attach hand/stair rail to Crystal rail 10mm glass	1 unit			Hand/Stair Rail Wood System
<b>HWC</b>	<b>Handrail Wall/Post Return Connector</b> • Used to cap the end of the hand rail tube against a wall, post or ground return	1 unit			QuickStep Merchandising

Available Color: Satin Aluminum

PRODUCTS MAY NOT BE EXACTLY AS ILLUSTRATED

Wood Railing System

Features:

- Choose from Classic Round or Flat Curved pickets.
- Picket systems for 36", 42" and 46" railing heights.
- Pickets come in a semi-gloss black powder coat finish.
- Low maintenance product made of 100% aluminum alloy that will never rust.
- Can be used with wood and composite materials.

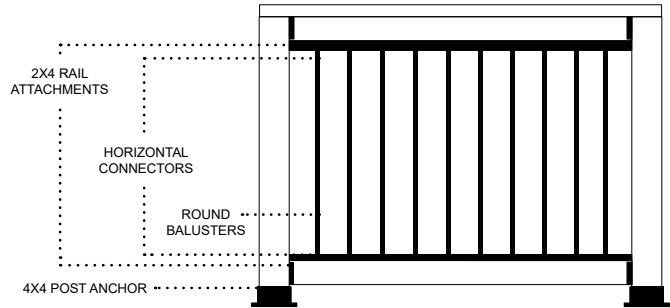

42" Railing

Tempered Glass

LED Railing

Round Balusters - for use with wood or composite materials

Code	Description	Qty	Price	
WPR26	<b>26" Round Balusters</b> (For 36" Railing) • Each package of 10 pieces will fill approximately four lineal feet of railing if balusters are spaced 4" o/c	10/pkg		<p>26" 32" 36"</p>
WPR32	<b>32" Round Balusters</b> (For 42" Railing) • Each package of 10 pieces will fill approximately four lineal feet of railing if balusters are spaced 4" o/c	10/pkg		
WPR36	<b>36" Round Balusters</b> (For 42"-46" Railing) • Each package of 10 pieces will fill approximately four lineal feet of railing if balusters are spaced 4" o/c	10/pkg		
WHCR	<b>Horizontal Connectors</b> (For use with WPR's above) • Fasteners Included	20/pkg		<p>WHCR WSCR</p>
WSCR	<b>Stair Connectors</b> (For use with WPR's above, designed for 35° angle) • Fasteners Included	20/pkg		

Crystal Rail

36" Railing

60" Railing

Fasteners

Assembly Parts

Available Color: (TB) Textured Black

Curved Balusters - for use with wood or composite materials

Code	Description	Qty	Price	
WPFC32	<b>32" Flat Curved Balusters</b> (For 36" Railing) • Each package of balusters will complete about 2 lineal feet of railing if spaced is between 3.5" - 3.875" • Balusters are 1/8" thick aluminum • Fasteners Included	5/pkg		<p>WPFC32</p>

Hand/Stair Rail

Wood System

QuickStep

Merchandising

Available Color: (BL) Black

PRODUCTS MAY NOT BE EXACTLY AS ILLUSTRATED

## Wood Railing System - using Regal Aluminum Pickets

**Features:**

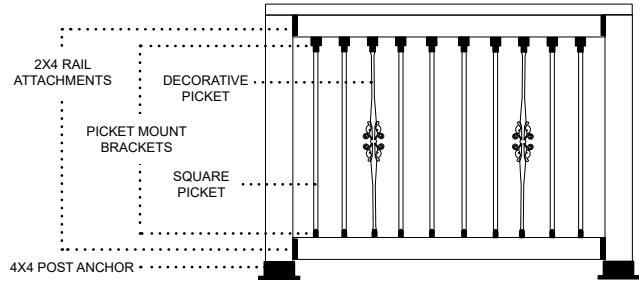

- Regal Ideas railing adapters allow you to use any of the picket styles for your wood or composite railing system.
- Low maintenance product made of 100% aluminum alloy that will never rust.
- For use with both wood or composite decking materials.

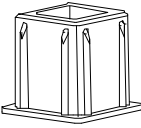
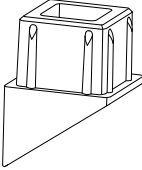
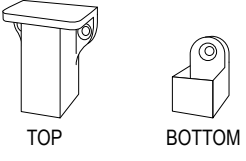

### Picket Mounting Brackets - for use with wood or composite

Code	Description	Qty	Price	
<b>WHCS</b>	<b>Horizontal Connectors for Square Pickets</b> • For use with Regal Aluminum Railing 3/4" straight pickets • Available in Black only	20/pkg		
<b>WSCS</b>	<b>Stair Connectors for Square Pickets</b> • For use with Regal Aluminum Railing 3/4" straight stair pickets (designed for 35° angle) • Available in Black only	20/pkg		
<b>WPB</b>	<b>Picket Mounting Bracket Set</b> • Powder coat aluminum casting • Accepts any Regal Aluminum Railing 3/4" straight or decorative picket styles • c/w fasteners • Available in Black and Yard Bronze	1 set		

### Decorative Picket Options - for use with Picket Mounting Brackets (WPB) above

Code	Description	Qty	Price	
<b>DP-NR</b>	<b>Narrow Round Decorative Picket</b>	1 unit		
<b>DP-WR</b>	<b>Wide Round Decorative Picket</b> <b>Note:</b> • Pickets require WPB Picket Mounting Brackets for installation on wood or composite rails • Not for use in stairs	1 unit		

### Regal Picket Options - for use with Picket Mounting Brackets (WPB/WHCS) above

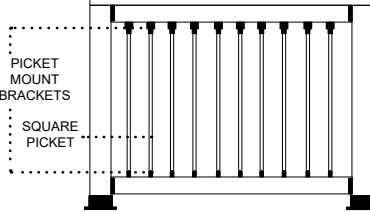
Code	Description	Qty	Price	
<b>SP6</b>	<b>Straight Pickets for 6' o/c</b>	14/pkg		
<b>SP8</b>	<b>Straight Pickets for 8' o/c</b>	19/pkg		
<b>SP10</b>	<b>Straight Pickets for 10' o/c</b> <b>Note:</b> Pickets require WPB, WHCS or WSCS Picket Mounting Brackets for installation on wood or composite rails	24/pkg		

Available Picket Colors: (0W) White, (BL) Black, (TP) Taupe, (YB) Yard Bronze, (TB) Textured Black

PRODUCTS MAY NOT BE EXACTLY AS ILLUSTRATED

42" Railing

Tempered Glass

LED Lighting

Crystal Rail

36" Railing

60" Railing

Fasteners

Assembly Parts

Hand/Stair Rail

Wood System

QuickStep

Merchandising

# Regal ideas

# WOOD RAILING SYSTEM

Give a custom finished look to any deck!

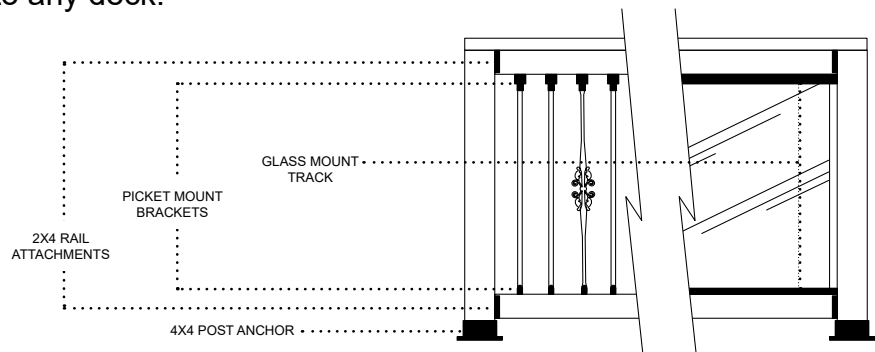

- Regal Ideas has everything you need to build your next custom wood deck railing.
- Go from Classic to Elegant with our aluminum railing pickets or use our Glass mount track to install any of our Tempered Glass panels.

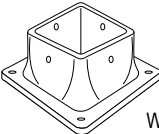
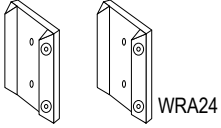

## Post and Rail Attachments - for use with wood or composite materials

Code	Description	Qty	Price	
WPA44	<b>4"X4" Post Anchor</b> <ul style="list-style-type: none"> <li>• For 4"x4" Wood or Composite posts</li> <li>• Includes Fasteners</li> <li>• Natural Cedar color</li> </ul> <b>Note:</b> Not to be used on deck surfaces higher than 24" above grade	1 unit		
WRA24	<b>Rail Attachment for Wood Railing and Fence</b> <ul style="list-style-type: none"> <li>• Includes Fasteners</li> <li>• Natural Cedar color</li> </ul>	1 set		

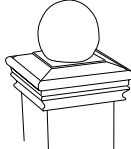
## Post Caps - for 4"x4" wood posts

Code	Description	Qty	Price	
WPC-B	<b>Ball Decorative 4x4 Post Cap</b>	1 unit		
WPC-P	<b>Pyramid Decorative 4x4 Post Cap</b>	1 unit		
WPC-T	<b>Tower Decorative 4x4 Post Cap</b> <ul style="list-style-type: none"> <li>• For nominal 4"x4" Wood or Composite posts</li> <li>• Hidden claw system, grips onto post</li> <li>• No Fasteners or adhesive required</li> </ul>	1 unit		

Available Colors: (NC) Natural Cedar, (BL) Black, (YB)Yard Bronze

## Gate Packages - INCLUDES: Rails, hinge post, latch post, pickets, hinges and latch

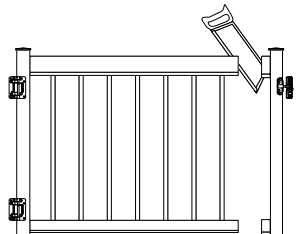
Code	Description	Qty	Price	
ASGP	<b>42"H x 48"W Gate Package (Straight 3/4" Pickets)</b> <ul style="list-style-type: none"> <li>• Fits openings up to 48"</li> </ul>	1 pkg		
WGP	<b>42"H x 48"W Gate Package (1 9/16" Wide Pickets)</b> <ul style="list-style-type: none"> <li>• Fits openings up to 48"</li> </ul>	1 pkg		

Available Colors: (0W) White, (BL) Black, (TP) Taupe, (YB)Yard Bronze, (TB) Textured Black

PRODUCTS MAY NOT BE EXACTLY AS ILLUSTRATED

42" Railing

Tempered Glass

LED Lighting

Crystal Rail

36" Railing

60" Railing

Fasteners

Assembly Parts

Hand/Stair Rail

Wood System

QuickStep

Merchandising

Wood Railing System - using Regal Tempered Glass

Features:

- Regal Ideas Glass Mount Track (WGT) allows you to install 1/4" (6mm) tempered glass to your wood or composite railing system.
- Easy to install.

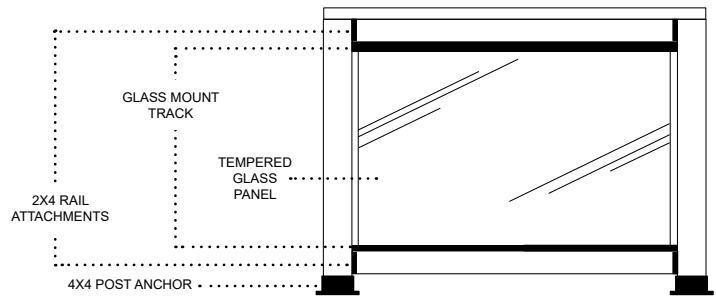

42" Railing

Tempered Glass

LED Lighting

Glass Mounting Track - For use with wood or composite

Code	Description	Qty	Price
<b>WGT</b>	<b>Glass Mounting Track Set</b> <ul style="list-style-type: none"> <li>• For wood railing</li> <li>• 68" length, for 6' o/c</li> <li>• Fasteners included</li> </ul> Color: (YB) Yard Bronze	1 set	

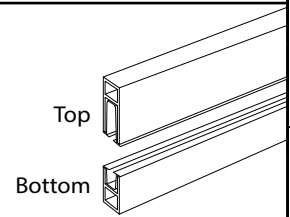

Crystal Rail

36" Railing

Tempered Glass Panels 35 7/8" H x 1/4" T (6mm) - For use with Glass Mounting Track (WGT) above

Code	Description	Qty	Price
<b>CTG6</b>	<b>6" Tempered Glass Panel</b>	1 panel	
<b>CTG9</b>	<b>9" Tempered Glass Panel</b>	1 panel	
<b>CTG12</b>	<b>12" Tempered Glass Panel</b>	1 panel	
<b>CTG15</b>	<b>15" Tempered Glass Panel</b>	1 panel	
<b>CTG18</b>	<b>18" Tempered Glass Panel</b>	1 panel	
<b>CTG21</b>	<b>21" Tempered Glass Panel</b>	1 panel	
<b>CTG24</b>	<b>24" Tempered Glass Panel</b>	1 panel	
<b>CTG27</b>	<b>27" Tempered Glass Panel</b>	1 panel	
<b>CTG30</b>	<b>30" Tempered Glass Panel</b>	1 panel	
<b>CTG33</b>	<b>33" Tempered Glass Panel</b>	1 panel	
<b>CTG36</b>	<b>36" Tempered Glass Panel</b>	1 panel	
<b>CTG39</b>	<b>39" Tempered Glass Panel</b>	1 panel	
<b>CTG42</b>	<b>42" Tempered Glass Panel</b>	1 panel	
<b>CTG45</b>	<b>45" Tempered Glass Panel</b>	1 panel	
<b>CTG48</b>	<b>48" Tempered Glass Panel</b>	1 panel	
<b>CTG51</b>	<b>51" Tempered Glass Panel</b>	1 panel	
<b>CTG54</b>	<b>54" Tempered Glass Panel</b>	1 panel	
<b>CTG57</b>	<b>57" Tempered Glass Panel</b>	1 panel	
<b>CTG60</b>	<b>60" Tempered Glass Panel</b>	1 panel	
<b>CTG63</b>	<b>63" Tempered Glass Panel</b>	1 panel	
<b>CTG66</b>	<b>66" Tempered Glass Panel</b>	1 panel	

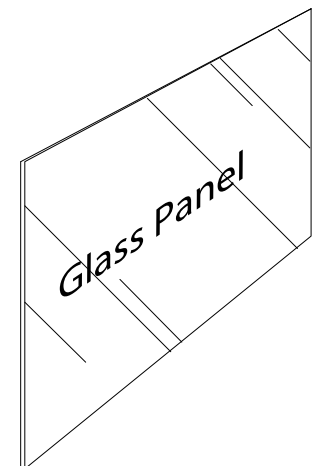

60" Railing

Fasteners

Assembly Parts

Hand/Stair Rail

Wood System

QuickStep

Merchandising

**Features:**

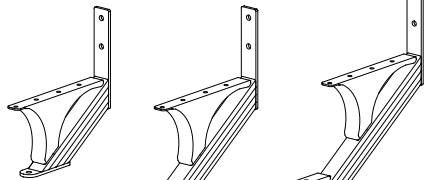
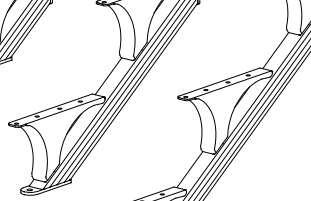
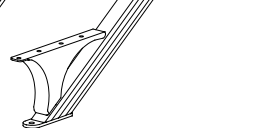
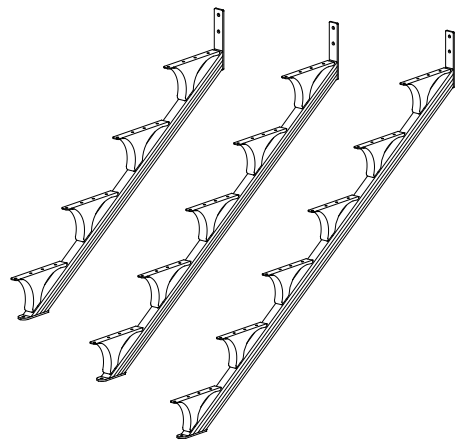
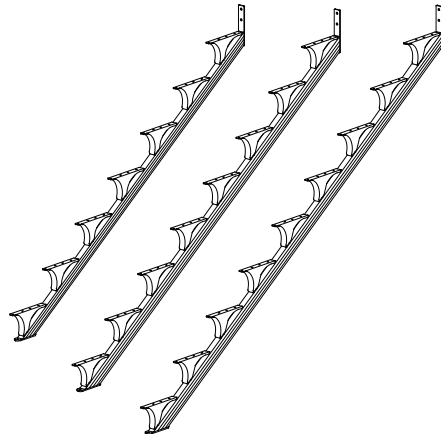

- Complete stair solution including stair treads, riser covers and stair stringers.
- Easy undermount installation.
- Stair Stringers made of never rust, premium UV powder coated aluminum alloy.
- Tread increments from 1 to 9 steps.

## Aluminum Stair Stringers (2 per package)

Code	Description	Qty	Price	
<b>QS-1</b> <b>1 Step Aluminum Stair Stringer</b> <i>Rise to Deck: 15", Run: 10.5"</i>		2/pkg		42" Railing
				Tempered Glass
				LED Lighting
<b>QS-2</b> <b>2 Step Aluminum Stair Stringer</b> <i>Rise to Deck: 22.5", Run: 21"</i>		2/pkg		Crystal Rail
				36" Railing
<b>QS-3</b> <b>3 Step Aluminum Stair Stringer</b> <i>Rise to Deck: 30", Run: 31.5"</i>		2/pkg		60" Railing
<b>QS-4</b> <b>4 Step Aluminum Stair Stringer</b> <i>Rise to Deck: 37.5", Run: 42"</i>		2/pkg		Fasteners
<b>QS-5</b> <b>5 Step Aluminum Stair Stringer</b> <i>Rise to Deck: 45", Run: 52.5"</i>				Assembly Parts
<b>QS-6</b> <b>6 Step Aluminum Stair Stringer</b> <i>Rise to Deck: 52.5", Run: 63"</i>				Hand/Stair Rail
<b>QS-7</b> <b>7 Step Aluminum Stair Stringer</b> <i>Rise to Deck: 60", Run: 73.5"</i>		2/pkg		Wood System
<b>QS-8</b> <b>8 Step Aluminum Stair Stringer</b> <i>Rise to Deck: 67.5", Run: 84"</i>				QuickStep
<b>QS-9</b> <b>9 Step Aluminum Stair Stringer</b> <i>Rise to Deck: 75", Run: 94.5"</i>				Merchandising

Available Colors: (0W) White, (BL) Textured Black, (YB)Yard Bronze

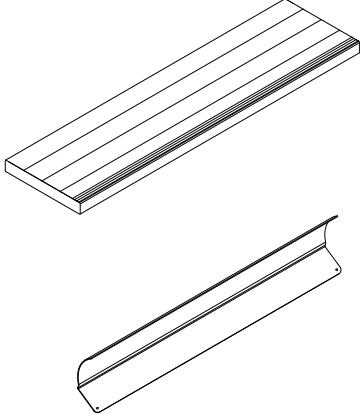
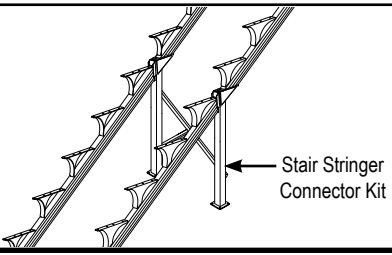
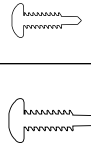
PRODUCTS MAY NOT BE EXACTLY AS ILLUSTRATED

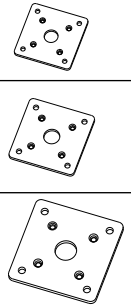
Stair Treads and Riser Covers - For use with QuickStep Stair Stringers				42" Railing
Code	Description	Qty	Price	Tempered Glass
<b>QST4</b>	<b>Stone Wood Stair Tread</b> <ul style="list-style-type: none"> <li>Made of high strength S-Glass fiber to accommodate up to 36" wide stair stringer spacing</li> <li>Quick undermount attaching hides fasteners</li> <li>Can be cut to any length</li> <li>Colors: Natural Cedar, Slate Gray</li> <li>Size: 48"L x 11"D x 1 1/2"H</li> <li>Fasteners and MPI insert sold separately</li> </ul>	1 unit		
<b>QSR4</b>	<b>Stair Riser Cover</b> <ul style="list-style-type: none"> <li>Aluminum riser cover</li> <li>Attaches easily to close in back of stair</li> <li>Colors: White, Black, Yard Bronze</li> <li>Size: 7-3/8"W x 3"D x 48"L</li> <li>Fasteners sold separately</li> </ul>	1 unit		
Stair Stringer Connector Kit				Crystal Rail
Code	Description	Qty	Price	LED Lighting
<b>QSC</b>	<b>Stair Stringer Connector Kit</b> <ul style="list-style-type: none"> <li>Designed to connect second stringer to QS7 but can be cut to size for connecting to smaller stringers</li> <li>Includes:                             <ul style="list-style-type: none"> <li>Two 52 1/4" x 2 1/4" posts, connection adapter brackets, cross brace and attached base plate</li> </ul> </li> <li>Fasteners sold separately</li> <li>Colors: Black, White, Yard Bronze</li> </ul>	1 kit		
Fasteners and Mounting Plates				60" Railing
Code	Description	Qty	Price	Fasteners
<b>WCS-50</b>	<b>#10 x 3/4" Self Drilling Screws</b> <ul style="list-style-type: none"> <li>To mount riser cover (QSR4) to stair stringers</li> </ul>	24/pkg		
<b>S114</b>	<b>#10 x 1 1/4" Self Drilling Screw</b> <ul style="list-style-type: none"> <li>To attach QuickStep stair treads to QuickStep stair stringers</li> </ul>	24/pkg		
<b>MB3</b>	<b>3/8" x 2 3/4" Structural Bolt c/w nut</b> <ul style="list-style-type: none"> <li>For use with mounting plate to stair treads</li> <li>Hot dipped galvanized</li> </ul>	24/pkg		
<b>MPI</b>	<b>Mounting Plate Insert</b> <ul style="list-style-type: none"> <li>Aluminum insert for mounting post on QST4 Stair Treads (2 pieces, 12" length)</li> <li>Fasteners sold separately</li> </ul>	2 pcs		
<b>MP4</b>	<b>4" Aluminum Bolt-Through Mounting Plate</b> <ul style="list-style-type: none"> <li>For 2 1/4" post (under or PSB side mount)</li> <li>Mill finish aluminum</li> </ul>	1 unit		
<b>MP5</b>	<b>5" Aluminum Bolt-Through Mounting Plate</b> <ul style="list-style-type: none"> <li>For Crystal Rail (under or sidemount)</li> <li>Mill finish aluminum</li> </ul>	1 unit		
<b>MP6</b>	<b>6" Aluminum Bolt-Through Mounting Plate</b> <ul style="list-style-type: none"> <li>For 4" Posts</li> <li>Mill finish aluminum</li> </ul>	1 unit		

PRODUCTS MAY NOT BE EXACTLY AS ILLUSTRATED



# Regal ideas

# MERCHANDISING DISPLAYS

Capture the attention of your in-store customers at the time and place of the potential purchase with one of Regal ideas aluminum railing displays. Regal ideas displays come pre-wired with our LED system, and showcase Regal ideas available colors and profiles. Regal ideas displays add results to your bottom line and improve your customers shopping experience! Contact your Territory Manager to order one of these displays below.

## Counter Top Display

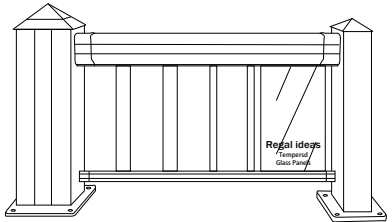
Code	Description	Qty	Price	
<b>MRH-C</b>	<b>Counter Top Railing Display</b> <ul style="list-style-type: none"> <li>c/w LED System</li> <li>Includes the following:                             <ul style="list-style-type: none"> <li>4" and 2 1/4" Posts</li> <li>Wide and Narrow Pickets</li> <li>Tempered Glass</li> <li>Brochures and holder</li> </ul> </li> <li>Dimensions: 4" D x 27" L x 16" H</li> </ul>	1 unit		

## L-Display

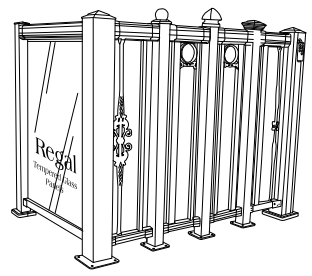
Code	Description	Qty	Price	
<b>MRL-C</b>	<b>L-Display - Railing</b> <ul style="list-style-type: none"> <li>c/w LED System</li> <li>Includes the following:                             <ul style="list-style-type: none"> <li>4" and 2 1/4" Posts</li> <li>Decorative Pickets, Inserts and Post Caps</li> <li>Wide Pickets and Narrow Pickets</li> <li>Tempered Glass</li> <li>Complete with P.O.P artwork</li> </ul> </li> <li>Dimensions: 36" D x 53.5" L x 42" H</li> </ul>	1 unit		

## 3 Tier Display

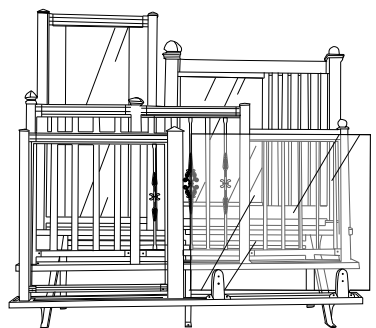
Code	Description	Qty	Price	
<b>MRT-C</b>	<b>3 Tier Railing</b> <ul style="list-style-type: none"> <li>c/w LED System</li> <li>Includes the following:                             <ul style="list-style-type: none"> <li>4" &amp; 2 1/4" Posts at 42" Height, plus 36" High Railing</li> <li>60" Tempered Glass Wind Wall/Pool Railing</li> <li>Decorative Pickets and Post Caps</li> <li>Wide and Narrow Pickets</li> <li>Complete Wood Accessories Section</li> <li>Crystal Rail Section</li> <li>Complete with P.O.P artwork</li> </ul> </li> <li>Dimensions: 30"D x 90"W x 80"H</li> </ul>	1 unit		

## Wood Accessories Display

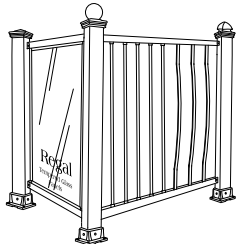
Code	Description	Qty	Price	
<b>MRW-C</b>	<b>Wood Accessories Display</b> <ul style="list-style-type: none"> <li>Includes the following:                             <ul style="list-style-type: none"> <li>Round and Curved Balusters</li> <li>Decorative Post Caps</li> <li>Post and Rail attachments</li> <li>Complete with P.O.P artwork</li> </ul> </li> <li>Finished Dimensions: 36" D x 48" L x 42" H</li> </ul> <p><b>NOTE:</b> Dealer to supply wood for display</p>	1 unit		

See Regal ideas product binder for color images

PRODUCTS MAY NOT BE EXACTLY AS ILLUSTRATED

42" Railing  
Tempered Glass  
LED Lighting  
Crystal Rail  
36" Railing  
60" Railing  
Fasteners  
Assembly Parts  
Hand/Stair Rail  
Wood System  
QuickStep  
Merchandising

# Regal ideas

# PRODUCT MERCHANDISERS

Regal ideas merchandising solutions are designed to:

- Increase sales
- Create awareness
- Improve Category Management
- Increase space productivity
- Increase transactions
- Easy to shop merchandisers
- Be in-stock, meet customer needs
- Integrate together to provide a complete solution

## Regal Railing Product Center

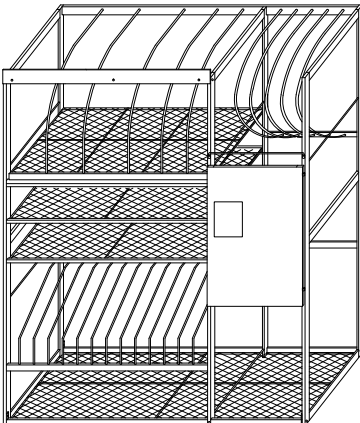
Code	Description	Qty	Price	
M-R-M6	<b>Regal Railing Product Center</b> <ul style="list-style-type: none"> <li>• Merchandiser for Regal Railing products:                             <ul style="list-style-type: none"> <li>• Posts</li> <li>• Top and Bottom rails</li> <li>• Accessories</li> <li>• Narrow and Wide Pickets</li> </ul> </li> <li>• Includes artwork, brochures and all point-of-purchase materials</li> <li>• Frame color: Yard Bronze</li> <li>• Dimensions: 78"W x 36"D x 98"H</li> <li>• Merchandiser only, Product not included</li> </ul> <p>See Regal ideas product binder for color images</p>	1 unit		

## Regal Railing Tempered Glass Center

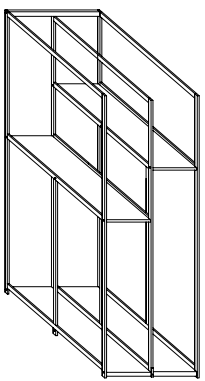
Code	Description	Qty	Price	
M-R-GR	<b>Regal Railing Tempered Glass Panel Center</b> <ul style="list-style-type: none"> <li>• Merchandiser for various tempered glass panel sizes</li> <li>• Frame color: Yard Bronze</li> <li>• Dimensions: 19"W x 42"D x 98"H</li> <li>• Merchandiser only, Product not included</li> </ul> <p>See Regal ideas product binder for color images</p>	1 unit		

## QuickStep Stair Center

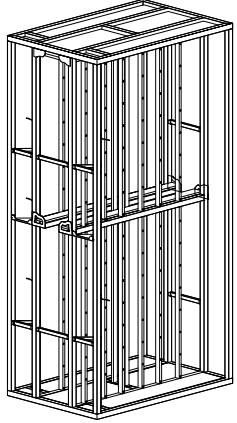
Code	Description	Qty	Price	
MQM4	<b>QuickStep Stair Center</b> <ul style="list-style-type: none"> <li>• A complete retail solution for outdoor stairs</li> <li>• 4-sided adjustable merchandiser for:                             <ul style="list-style-type: none"> <li>• Stair stringers (1 to 7 step) in 3 colors (White, Black, Yard Bronze)</li> <li>• Stair Treads</li> <li>• Stair Riser Covers</li> <li>• Stair Stringer Connector Kit</li> </ul> </li> <li>• Includes brochures and all point-of-purchase material</li> <li>• Frame color: Yard Bronze</li> <li>• Dimensions: 36"W x 48"D x 101"H</li> <li>• Merchandiser only, product not included</li> </ul> <p>See Regal ideas product binder for color images</p>	1 unit		

PRODUCTS MAY NOT BE EXACTLY AS ILLUSTRATED

42" Railing

Tempered Glass

LED Lighting

Crystal Rail

36" Railing

60" Railing

Fasteners

Assembly Parts

Hand/Stair Rail

Wood System

QuickStep

Merchandising