

IDEA BOOK

RENIN INTERIOR DOOR SYSTEMS



WELCOME TO RENIN

Renin is an innovative manufacturer of door systems and hardware for door manufacturers and door fabricators. Renin also manufactures and distributes sliding, bypass and bifold closet doors, room dividers, fabricated glass and decorative mirrors to the residential construction and remodeling markets.

In the 1960s, Renin invented the sliding mirror closet door and that innovation legacy endures with the supply of well-designed and long-lasting products to customers world-wide.

The name Renin is the combination of words that describes the mindset and culture of the company:

REdefining a**ND** **IN**novating' = **RENIN**

On November 1st, 2013, BBX Capital Corporation announced the acquisition of the assets and operations of Renin Corp. Under BBX, the company has been restructured and streamlined to support strategic growth.

Former operation division Home Decor Innovations is now operating as **Renin US LLC**. The former Canadian operating divisions: Kingstar Products, DSH Hardware, Kingstar West and JJ Home Products are now operating as **Renin Canada Corp.**

Under BBX, Renin has strengthened its commitment to innovation and new products in Renin's chosen product categories:

- Mirror & Panel Closet Doors
- European Style Wardrobe Closet Doors
- Framed and Frameless Wall Mirrors & Accessories
- Shower Doors
- Sliding, Bypass, Bifold, Pivot, Pocket, Barn Door and Overlay Door Hardware Components

With manufacturing and distribution centers located in Tupelo, Mississippi (United States), Brampton, Ontario (Canada), and London (England) Renin supplies products to retail and wholesale channels of distribution.

Renin's vision is to create inspiring products and solutions through innovation, expertise and customer focus.

SALES & CUSTOMER SERVICE

Customer Service:

Toll Free: 1-800-493-5263

Fax: 1-800-481-4659

DISTRIBUTION LOCATIONS



SHIPPING ADDRESSES:

Renin Canada Corp.
110 Walker Drive
Brampton, Ontario
L6T 4H6 Canada

Renin US LLC
1141 Ryder Street
Tupelo, Mississippi
38804 USA



DOOR SELECTION OVERVIEW
DOOR TYPE & MATERIAL OPTIONS
INSERT PANEL OPTIONS
SECTION

EXTRUDED ALUMINUM SWING, SLIDING & BYPASS ROOM DIVIDER DOORS

- CLEAR / SMOKED / BRONZE MIRROR
- OPAQUE WHITE / CLEAR LAMINATED GLASS
- WHITE / BLACK / RED PAINTED GLASS

Pages
8 - 18

EURO WOOD BYPASS, BIFOLD & PIVOT DOORS

- TEMPERED FROSTED GLASS (STANDARD)
- CLEAR / SMOKED / BRONZE MIRROR
- OPAQUE WHITE / CLEAR LAMINATED GLASS
- WHITE / BLACK / RED PAINTED GLASS

Pages
19 - 34

WOOD SLIDING DOORS

- CLEAR / SMOKED / BRONZE MIRROR
- OPAQUE WHITE / CLEAR LAMINATED GLASS
- WHITE / BLACK / RED PAINTED GLASS

Pages
35 - 39

STEEL FRAMELESS & FRAMED BYPASS, BIFOLD, PIVOT & OVERLAY DOORS

- FLUSH PANEL (FRAMED)
- MOLDED PANEL (FRAMED)
- CLEAR / SMOKED / BRONZE MIRROR
- OPAQUE WHITE / CLEAR LAMINATED GLASS
- WHITE / BLACK / RED PAINTED GLASS

Pages
40 - 64

ALUMINUM FRAMELESS & FRAMED BYPASS & BIFOLD DOORS

- CLEAR / SMOKED / BRONZE MIRROR
- OPAQUE WHITE / CLEAR LAMINATED GLASS
- WHITE / BLACK / RED PAINTED GLASS

Pages
65 - 73

STEEL FRAMED & FRAMELESS FINISHES AVAILABLE



LAMINATED STEEL FRAMED FINISHES AVAILABLE



ALUMINUM FRAMED & FRAMELESS FINISHES AVAILABLE

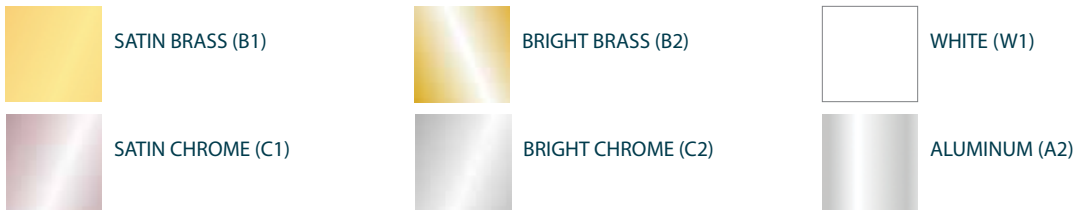

EXTRUDED ALUMINUM FRAME FINISHES AVAILABLE



EURO WOOD FRAME FINISHES AVAILABLE



WOOD DOOR OPTION



BARN DOOR FINISH KIT OPTIONS AVAILABLE

















GLASS INSERTS AVAILABLE

 CLEAR MIRROR Safety-backed 3mm	 SMOKED MIRROR Safety-backed 3mm	 BRONZE MIRROR Safety-backed 3mm
 TEMPERED FROSTED GLASS for standard Euro Wood doors 4mm	 OPAQUE WHITE LAMINATED GLASS 6mm	 CLEAR LAMINATED GLASS 6mm
 WHITE BACK PAINTED GLASS 3mm	 BLACK BACK PAINTED GLASS 3mm	 RED BACK PAINTED GLASS 3mm

SPECIAL ORDER GLASS INSERTS AVAILABLE

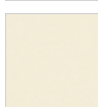
 CHINCHILLA GLASS 3mm	 WATER GLASS 3mm	
 LIGHTING SQUARES GLASS 4mm	 GOTHIC GLASS 4mm	 CATHEDRAL GLASS 4mm

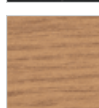
FLUSH PANEL INSERTS AVAILABLE

 WHITE 1/8" (3mm)	 ALMOND 1/8" (3mm)	 OAK 1/8" (3mm)
 WHITEWOOD 1/8" (3mm)	 LAMINATED OAK 1/8" (3mm)	 LAMINATED MAHOGANY 1/8" (3mm)
 ANGEL WHITE 1/2" (12mm)	 COUNTRY PINE 1/2" (12mm)	 TRADITIONAL OAK 1/2" (12mm)
 MISTY GREY 1/2" (12mm)	 FORMAL BLACK 1/2" (12mm)	 IMPERIAL OYSTER 1/2" (12mm)
 VICTORIAN CHERRY 1/2" (12mm)	 LAMINATED OAK 1/2" (12mm)	 LAMINATED MAHOGANY 1/2" (12mm)

ES94 Extruded Aluminum Series Swing Mirror Door System



Cross Sectional

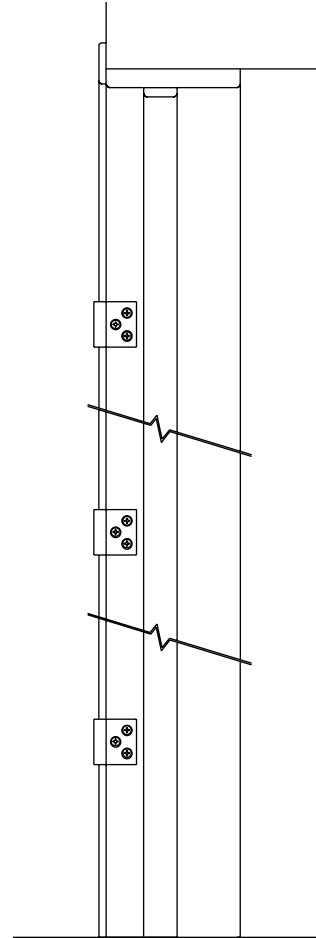

Product Description

- 1" x 1-1/4" Extruded Aluminum Door frame
- Single 180° swing
- No top and bottom tracks required
- Single or double-sided 3mm mirror glass, back-painted glass or single 6mm laminated glass inserts available (double-sided 1 Lite clear mirror glass shown)
- Includes all hinges, pull and latch
- Factory finished, ready-to-install
- Custom sizes made to order
- See pages 6 and 7 for frame, glass and panel insert options

Profile

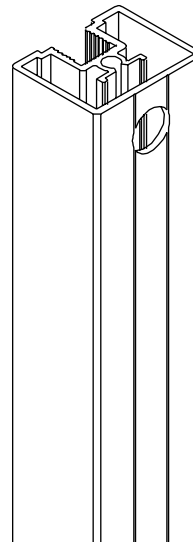

Safety Backing - Conforms to CGSB 12.5-M86 Type 3C (Canada) and ANSI Z97.1-1984 (US)

4100 Extruded Aluminum Series Overlay Mirror Door System



Cross Sectional

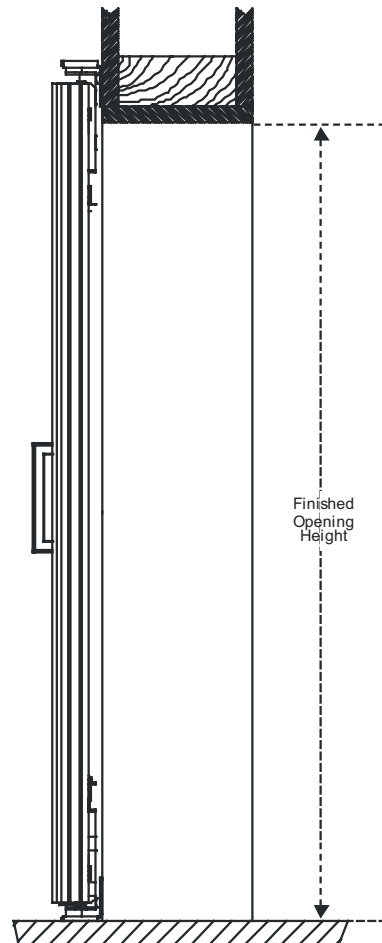

Product Description

- 1" x 1-1/4" Extruded Aluminum Door frame
- Acts like a conventional swing-out door
- No top and bottom tracks required
- Single or double-sided 3mm mirror glass, back-painted glass or single 6mm laminated glass inserts available (double-sided 1 Lite clear mirror glass shown)
- Includes all hinges, pull and latch
- Factory finished, ready-to-install
- Custom sizes made to order
- See pages 6 and 7 for frame, glass and panel insert options

Profile

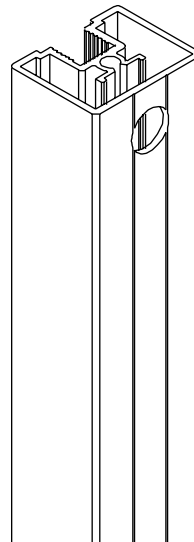

Safety Backing - Conforms to CGSB 12.5-M86 Type 3C (Canada) and ANSI Z97.1-1984 (US)

7042 Extruded Aluminum Series Bypass Closet Door System



Cross Sectional

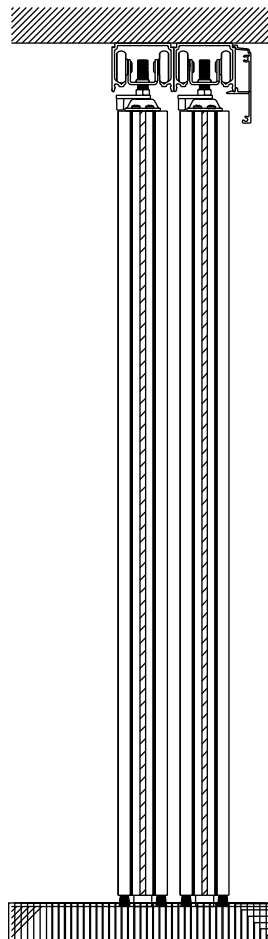

Product Description

- 2" x 1-3/8" Extruded Aluminum Door frame
- Top roll system
- No bottom track
- Single or double-sided 3mm mirror glass, back-painted glass or single 6mm laminated glass inserts available (double-sided 1 Lite white painted glass shown)
- Factory finished, ready-to-install
- Custom sizes made to order
- See pages 6 and 7 for frame, glass and panel insert options

Profile

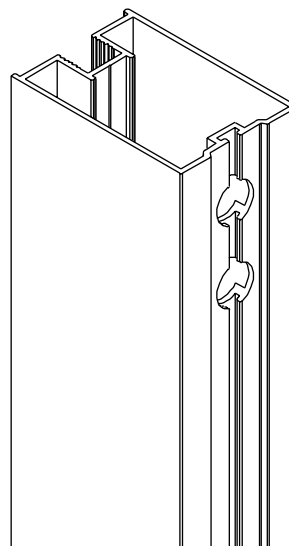

Safety Backing - Conforms to CGSB 12.5-M86 Type 3C (Canada) and ANSI Z97.1-1984 (US)



7041 Extruded Aluminum Series Sliding Wall Mounted Room Divider Door System



Cross Sectional

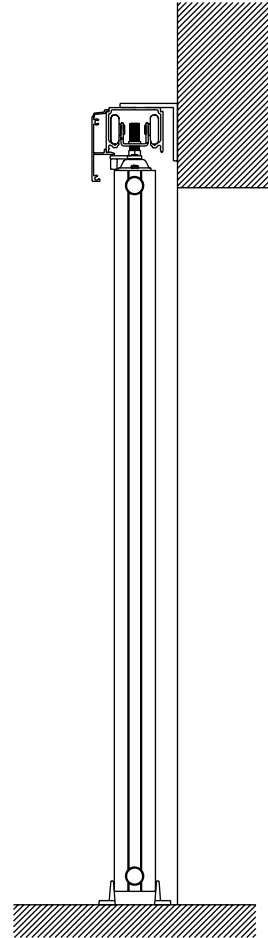

Product Description

- 2" x 1-3/8" Extruded Aluminum Door frame
- Top roll system
- No bottom track
- Single or double-sided 3mm mirror glass, back-painted glass or single 6mm laminated glass inserts available (1 Lite opaque white laminated glass shown)
- Factory finished, ready-to-install
- Custom sizes made to order
- See pages 6 and 7 for frame, glass and panel insert options

Profile

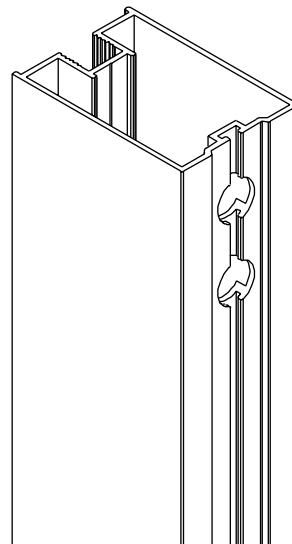

Safety Backing - Conforms to CGSB 12.5-M86 Type 3C (Canada) and ANSI Z97.1-1984 (US)

7046 Extruded Aluminum Series Sliding Wall Mounted Room Divider Door System



Cross Sectional

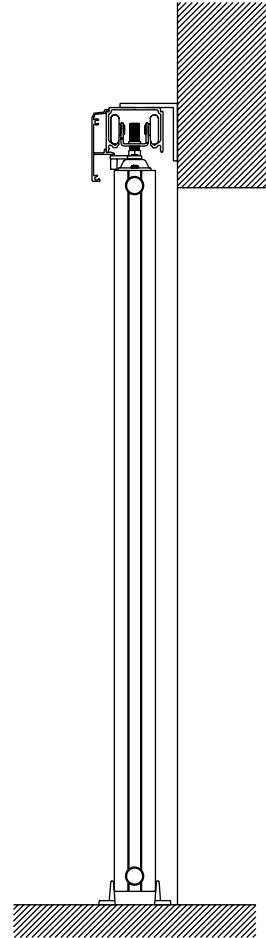

Product Description

- 3" x 1-3/8" Extruded Aluminum Door frame
- Top roll system
- No bottom track
- Single or double-sided 3mm mirror glass, back-painted glass or single 6mm laminated glass inserts available (double-sided 3 Lite white painted glass shown)
- Factory finished, ready-to-install
- Custom sizes made to order
- See pages 6 and 7 for frame, glass and panel insert options

Profile

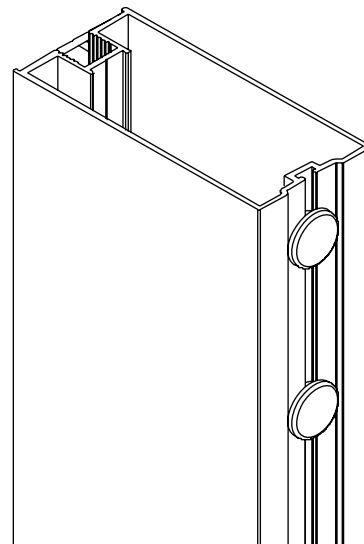

Safety Backing - Conforms to CGSB 12.5-M86 Type 3C (Canada) and ANSI Z97.1-1984 (US)

7039 Extruded Aluminum Series Bypass Ceiling Mounted Room Divider Door System



Cross Sectional

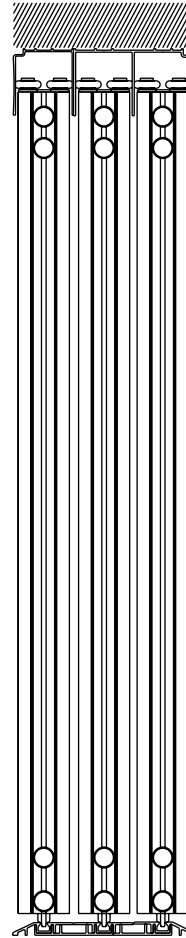

Product Description

- 2" x 1-3/8" Extruded Aluminum Door frame
- Bottom roll system with top track
- Single or double-sided 3mm mirror glass, back-painted glass or single 6mm laminated glass inserts available (1 Lite opaque white laminated glass shown)
- Factory finished, ready-to-install
- Custom sizes made to order
- See pages 6 and 7 for frame, glass and panel insert options

Profile

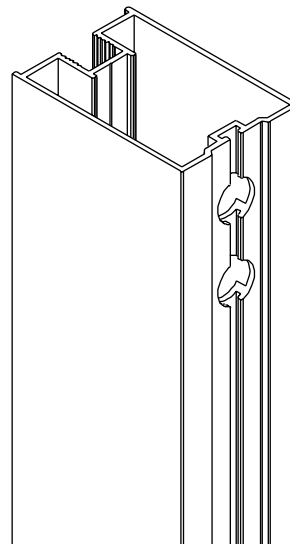

Safety Backing - Conforms to CGSB 12.5-M86 Type 3C (Canada) and ANSI Z97.1-1984 (US)

7053 Extruded Aluminum Series Bypass Ceiling Mounted Room Divider Door System



Cross Sectional

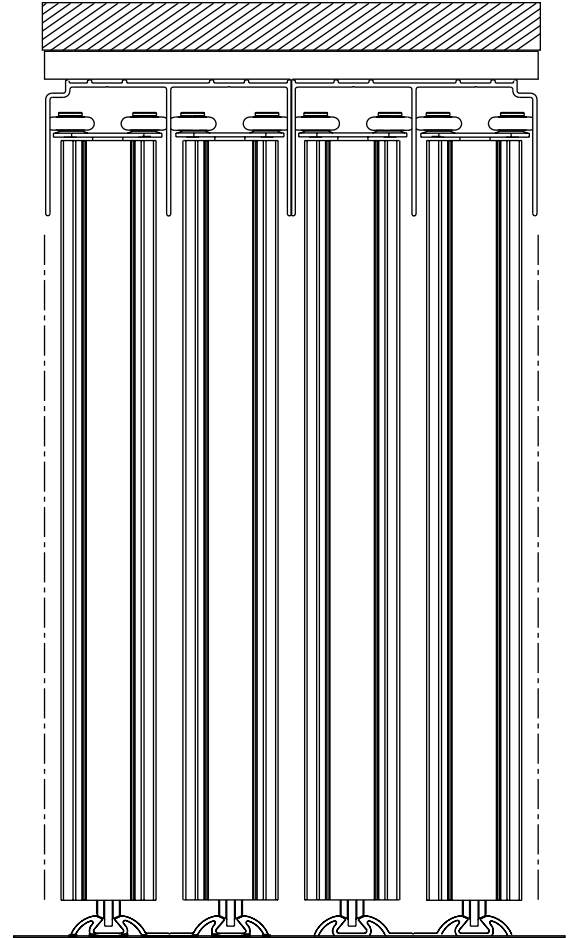

Product Description

- 3" x 1-3/8" Extruded Aluminum Door frames
- Bottom roll system with top track
- Single or double-sided 3mm mirror glass, back-painted glass or single 6mm laminated glass inserts available (4 Lite opaque white laminated glass shown)
- Factory finished, ready-to-install
- Custom sizes made to order
- See pages 6 and 7 for frame, glass and panel insert options

Profile

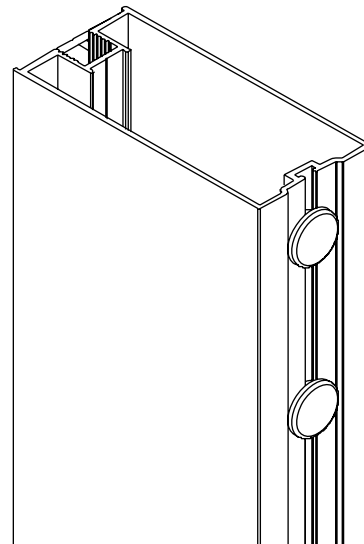

Safety Backing - Conforms to CGSB 12.5-M86 Type 3C (Canada) and ANSI Z97.1-1984 (US)



ES70 Extruded Aluminum Series Bypass Ceiling Mounted Room Divider Door System



Cross Sectional

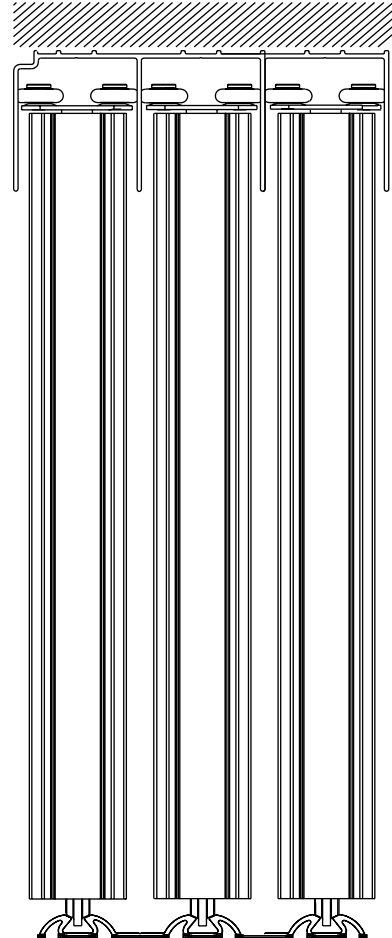

Product Description

- Extruded Aluminum Door frame
- Bottom roll system with built in anti-jump feature
- Single or double-sided 3mm mirror glass, back-painted glass or single 6mm laminated glass inserts available (double-sided 3 Lite red and black back-painted glass shown)
- Factory finished, ready-to-install
- Custom sizes made to order
- See pages 6 and 7 for frame, glass and panel insert options
- Soft-close mechanism can be purchased pre-installed as added option (P/N BP118)



Safety Backing - Conforms to CGSB 12.5-M86 Type 3C (Canada) and ANSI Z97.1-1984 (US)

Profile

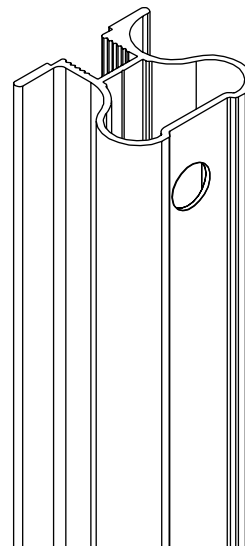

ES70 Extruded Aluminum Series Bypass Door System



Cross Sectional

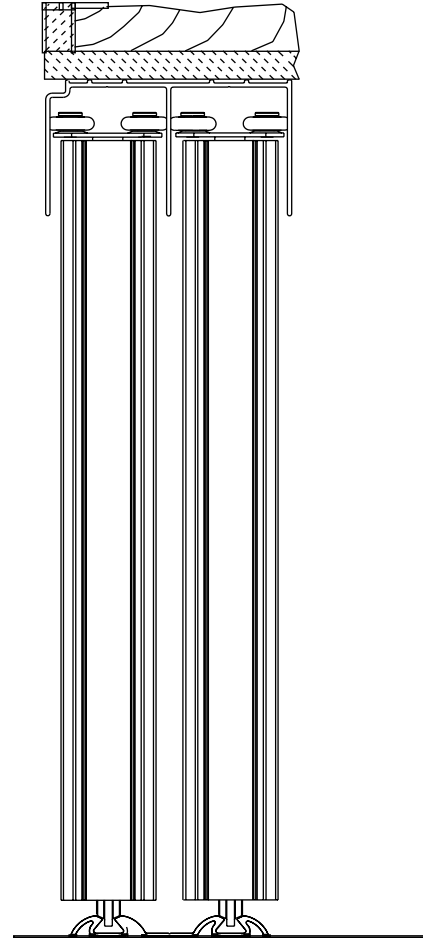

Product Description

- Extruded Aluminum Door frame
- Bottom roll system with built in anti-jump feature
- Single or double-sided 3mm mirror glass, back-painted glass or single 6mm laminated glass inserts available (1 Lite white opaque glass shown - single clear mirror glass shown inset)
- Factory finished, ready-to-install
- Custom sizes made to order
- See pages 6 and 7 for frame, glass and panel insert options
- Soft-close mechanism can be purchased pre-installed as added option (P/N BP118)



Safety Backing - Conforms to CGSB 12.5-M86 Type 3C (Canada) and ANSI Z97.1-1984 (US)

Profile

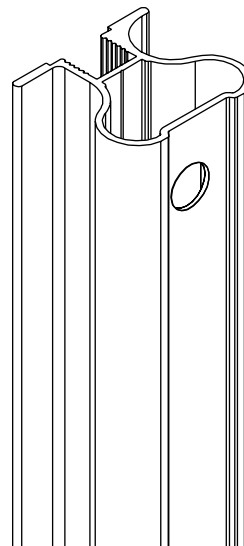

2400 Euro Wood Series Bypass Closet Door System



Cross Sectional

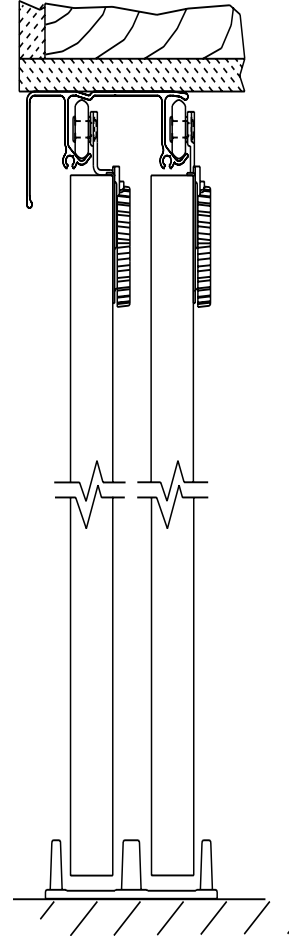

Product Description

- 1 Lite 2 panel system
- Top roll system with no bottom track
- Laminated Cherry frame has "wood" look
- Matching fascia
- Tempered frosted glass in standard sizes, mirror or back-painted glass options available custom size made to order
- Adjustable top rollers and bottom floor guide
- Standard sizes fit 4', 5', 6' widths and finished opening heights of 80-1/2" (+/- 1/8" adjustment)
- Factory finished, ready-to-install
- Doors can be trimmed 3/4" along the top to fit other door height openings as required
- See pages 6 and 7 for frame, glass and panel insert options

2400 Euro Wood Series Bypass Closet Door System



Cross Sectional

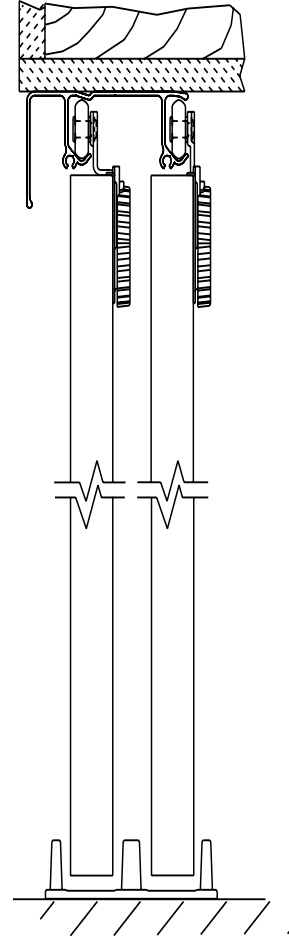

Product Description

- 1 Lite 2 panel system
- Top roll system with no bottom track
- Laminated White frame has "wood" look
- Matching fascia
- Tempered frosted glass in standard sizes, mirror or back-painted glass options available custom size made to order
- Adjustable top rollers and bottom floor guide
- Standard sizes fit 4', 5', 6' widths and finished opening heights of 80-1/2" (+/- 1/8" adjustment)
- Factory finished, ready-to-install
- Doors can be trimmed 3/4" along the top to fit other door height openings as required
- See pages 6 and 7 for frame, glass and panel insert options

2400 Euro Wood Series Bypass Closet Door System



Cross Sectional

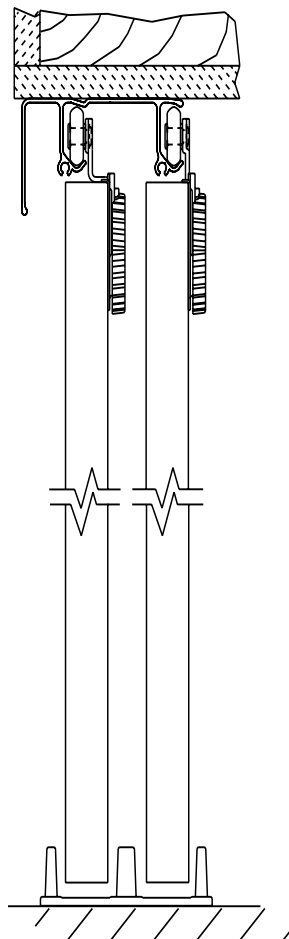

Product Description

- 1 Lite 2 panel system
- Top roll system with no bottom track
- Laminated Espresso frame has "wood" look
- Matching fascia
- Tempered frosted glass in standard sizes, mirror or back-painted glass options available custom size made to order
- Adjustable top rollers and bottom floor guide
- Standard sizes fit 4', 5', 6' widths and finished opening heights of 80-1/2" (+/- 1/8" adjustment)
- Factory finished, ready-to-install
- Doors can be trimmed 3/4" along the top to fit other door height openings as required
- See pages 6 and 7 for frame, glass and panel insert options

2401 Euro Wood Series Bypass Closet Door System



Cross Sectional

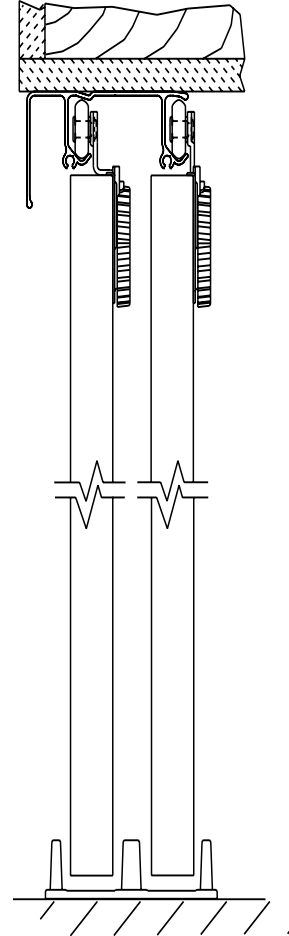

Product Description

- 3 Lite 2 panel system
- Top roll system with no bottom track
- Laminated Cherry frame has "wood" look
- Matching fascia
- Tempered frosted glass in standard sizes, mirror or back-painted glass options available custom size made to order
- Adjustable top rollers and bottom floor guide
- Standard sizes fit 4', 5', 6' widths and finished opening heights of 80-1/2" (+/- 1/8" adjustment)
- Factory finished, ready-to-install
- Doors can be trimmed 3/4" along the top to fit other door height openings as required
- See pages 6 and 7 for frame, glass and panel insert options

2401 Euro Wood Series Bypass Closet Door System



Cross Sectional

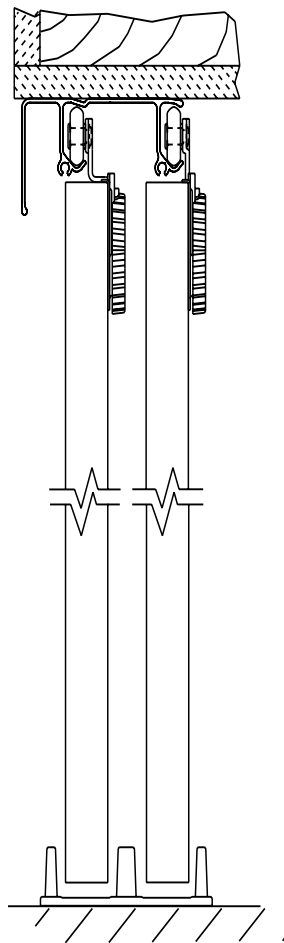

Product Description

- 3 Lite 2 panel system
- Top roll system with no bottom track
- Laminated White frame has "wood" look
- Matching fascia
- Tempered frosted glass in standard sizes, mirror or back-painted glass options available custom size made to order
- Adjustable top rollers and bottom floor guide
- Standard sizes fit 4', 5', 6' widths and finished opening heights of 80-1/2" (+/- 1/8" adjustment)
- Factory finished, ready-to-install
- Doors can be trimmed 3/4" along the top to fit other door height openings as required
- See pages 6 and 7 for frame, glass and panel insert options

2401 Euro Wood Series Bypass Closet Door System



Cross Sectional

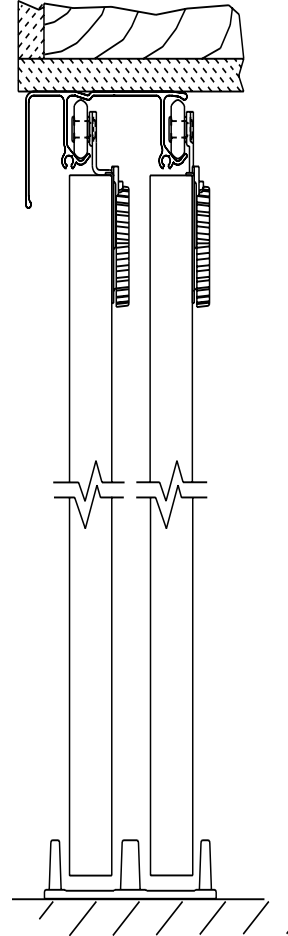

Product Description

- 3 Lite 2 panel system
- Top roll system with no bottom track
- Laminated Espresso frame has "wood" look
- Matching fascia
- Tempered frosted glass in standard sizes, mirror or back-painted glass options available custom size made to order
- Adjustable top rollers and bottom floor guide
- Standard sizes fit 4', 5', 6' widths and finished opening heights of 80-1/2" (+/- 1/8" adjustment)
- Factory finished, ready-to-install
- Doors can be trimmed 3/4" along the top to fit other door height openings as required
- See pages 6 and 7 for frame, glass and panel insert options

2402 Euro Wood Series Bypass Closet Door System



Cross Sectional

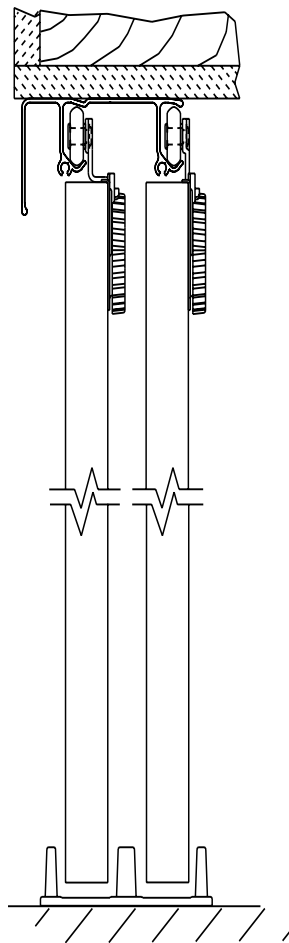

Product Description

- 5 Lite 2 panel system
- Top roll system with no bottom track
- Laminated Espresso frame has "wood" look
- Matching fascia
- Tempered frosted glass in standard sizes, mirror or back-painted glass options available custom size made to order
- Adjustable top rollers and bottom floor guide
- Standard sizes fit 4', 5', 6' widths and finished opening heights of 80-1/2" (+/- 1/8" adjustment)
- Factory finished, ready-to-install
- Doors can be trimmed 3/4" along the top to fit other door height openings as required
- See pages 6 and 7 for frame, glass and panel insert options

4401 Euro Wood Series Bifold Closet Door System



Cross Sectional

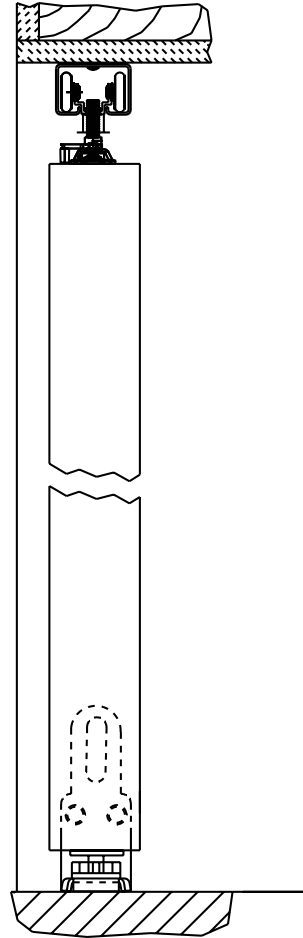

Product Description

- 1 Lite 2 panel system
- Top roller and pivot system with no bottom track
- Laminated White frame has "wood" look
- Matching fascia
- Tempered frosted glass in standard sizes, mirror or back-painted glass options available custom size made to order
- Standard sizes fit 24", 30", 36" widths and finished opening heights of 80-1/2" (+/- 1/4" adjustment)
- Factory finished, ready-to-install
- See pages 6 and 7 for frame, glass and panel insert options

4401 Euro Wood Series Bifold Closet Door System



Cross Sectional

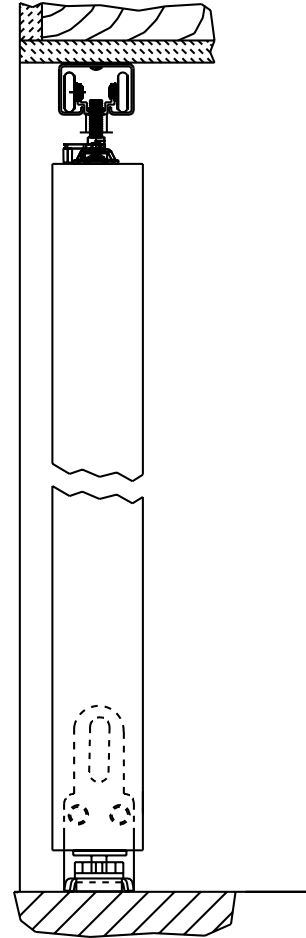

Product Description

- 1 Lite 2 panel system
- Top roller and pivot system with no bottom track
- Laminated Espresso frame has "wood" look
- Matching fascia
- Tempered frosted glass in standard sizes, mirror or back-painted glass options available custom size made to order
- Standard sizes fit 24", 30", 36" widths and finished opening heights of 80-1/2" (+/- 1/4" adjustment)
- Factory finished, ready-to-install
- See pages 6 and 7 for frame, glass and panel insert options



4402 Euro Wood Series Bifold Closet Door System



Cross Sectional

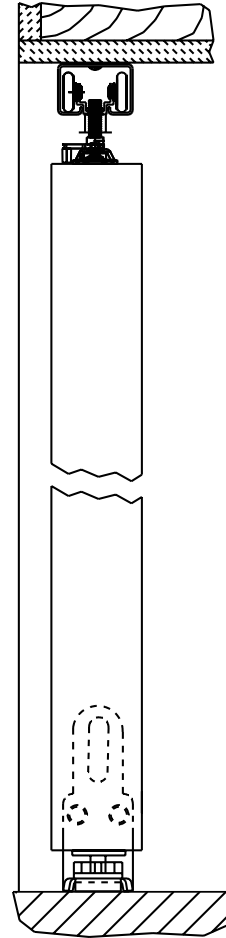

Product Description

- 3 Lite 2 panel system
- Top roller and pivot system with no bottom track
- Laminated White frame has "wood" look
- Matching fascia
- Tempered frosted glass in standard sizes, mirror or back-painted glass options available custom size made to order
- Standard sizes fit 24", 30", 36" widths and finished opening heights of 80-1/2" (+/- 1/4" adjustment)
- Factory finished, ready-to-install
- See pages 6 and 7 for frame, glass and panel insert options

4402 Euro Wood Series Bifold Closet Door System



Cross Sectional

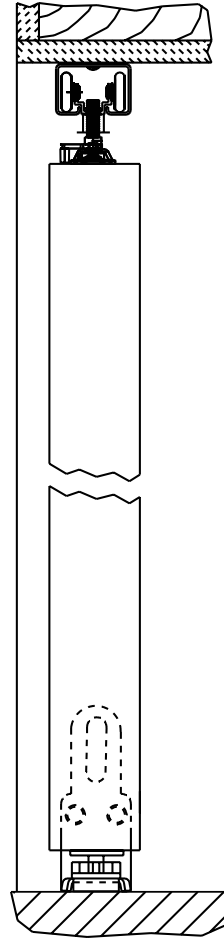

Product Description

- 3 Lite 2 panel system
- Top roller and pivot system with no bottom track
- Laminated Espresso frame has "wood" look
- Matching fascia
- Tempered frosted glass in standard sizes, mirror or back-painted glass options available custom size made to order
- Standard sizes fit 24", 30", 36" widths and finished opening heights of 80-1/2" (+/- 1/4" adjustment)
- Factory finished, ready-to-install
- See pages 6 and 7 for frame, glass and panel insert options

5401 Euro Wood Series Pivot Door System



Product Description

- 1 Lite 2 panel system
- Top and bottom pivot system with no bottom track
- Laminated White frame has "wood" look
- Matching fascia
- Tempered frosted glass in standard sizes, mirror or back-painted glass options available custom size made to order
- Standard sizes fit 24", 30", 36" widths and finished opening heights of 80-1/2" (+/- 1/4" adjustment)
- Factory finished, ready-to-install
- See pages 6 and 7 for frame, glass and panel insert options

5401 Euro Wood Series Pivot Door System



Product Description

- 1 Lite 2 panel system
- Top and bottom pivot system with no bottom track
- Laminated Espresso frame has "wood" look
- Matching fascia
- Tempered frosted glass in standard sizes, mirror or back-painted glass options available custom size made to order
- Standard sizes fit 24", 30", 36" widths and finished opening heights of 80-1/2" (+/- 1/4" adjustment)
- Factory finished, ready-to-install
- See pages 6 and 7 for frame, glass and panel insert options

5402 Euro Wood Series Pivot Door System



Product Description

- 3 Lite 2 panel system
- Top and bottom pivot system with no bottom track
- Laminated White frame has "wood" look
- Matching fascia
- Tempered frosted glass in standard sizes, mirror or back-painted glass options available custom size made to order
- Standard sizes fit 24", 30", 36" widths and finished opening heights of 80-1/2" (+/- 1/4" adjustment)
- Factory finished, ready-to-install
- See pages 6 and 7 for frame, glass and panel insert options

5402 Euro Wood Series Pivot Door System



Product Description

- 3 Lite 2 panel system
- Top and bottom pivot system with no bottom track
- Laminated Espresso frame has "wood" look
- Matching fascia
- Tempered frosted glass in standard sizes, mirror or back-painted glass options available custom size made to order
- Standard sizes fit 24", 30", 36" widths and finished opening heights of 80-1/2" (+/- 1/4" adjustment)
- Factory finished, ready-to-install
- See pages 6 and 7 for frame, glass and panel insert options



3407 Wood Door Series

Pine 1 Lite Straight Strap Wall Mounted Barn Door Kit System



Cross Sectional

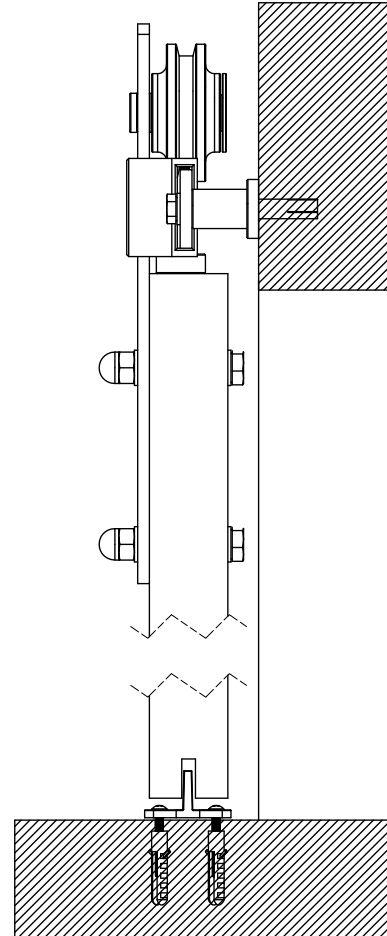

Product Description

- 36" x 84" x 1-3/8" 1 Lite Pine Door
- Use for closet, room divider or passage door applications
- Single or double-sided 3mm mirror glass, back-painted glass or single 6mm laminated glass inserts available (double-sided 1 Lite red back-painted glass shown)
- BD100K Straight Strap Barn Door Kit made of steel (Bronze shown)
- Ideal for openings 32" - 34" wide
- Unique barn door style hardware enables door to slide parallel to wall
- Available in three finishes
- Factory finished, ready-to-install
- Custom door sizes are not available
- See pages 6 and 7 for frame, glass and panel insert options

Safety Backing - Conforms to CGSB 12.5-M86 Type 3C (Canada) and ANSI Z97.1-1984 (US)

Hardware Finishes Available



Matt Black



Stainless Steel



Bronze

3407 Wood Door Series

Pine 1 Lite Top of Door Wall Mounted Barn Door Kit System



Cross Sectional

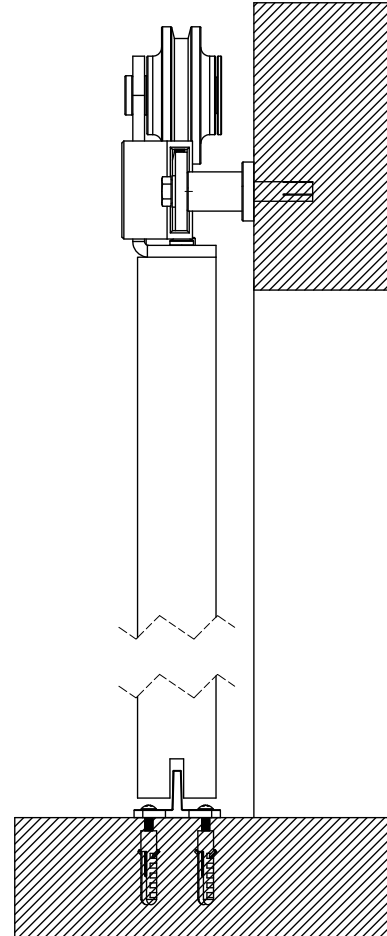

Product Description

- 36" x 84" x 1-3/8" 1 Lite Pine Door
- Use for closet, room divider or passage door applications
- Single or double-sided 3mm mirror glass, back-painted glass or single 6mm laminated glass inserts available (1 Lite opaque white laminated glass shown)
- BD101K Top of Barn Door Kit made of steel (Stainless Steel shown)
- Ideal for openings 32" - 34" wide
- Unique barn door style hardware enables door to slide parallel to wall
- Available in three finishes
- Factory finished, ready-to-install
- Custom door sizes are not available
- See pages 6 and 7 for frame, glass and panel insert options

Safety Backing - Conforms to CGSB 12.5-M86 Type 3C (Canada) and ANSI Z97.1-1984 (US)

Hardware Finishes Available



Matt Black



Stainless Steel



Bronze

3407 Wood Door Series

Pine 1 Lite Bent Strap Wall Mounted Barn Door Kit System



Cross Sectional

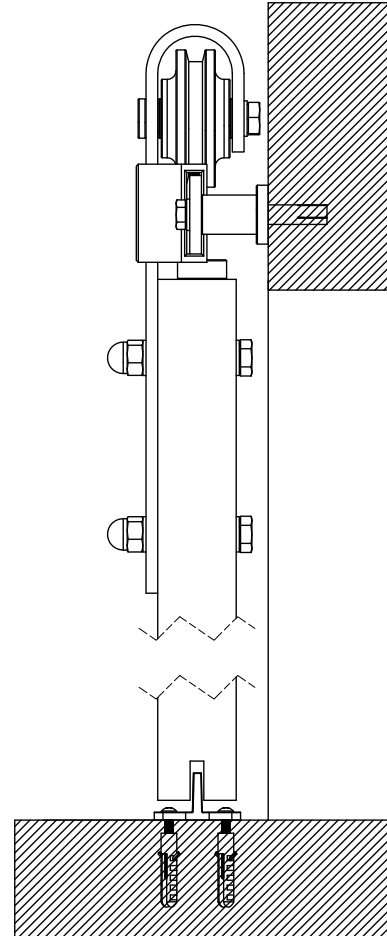

Product Description

- 36" x 84" x 1-3/8" 1 Lite Pine Door
- Use for closet, room divider or passage door applications
- Single or double-sided 3mm mirror glass, back-painted glass or single 6mm laminated glass inserts available (double-sided 1 Lite clear mirror glass shown)
- BD102K Straight Bent Barn Door Kit made of steel (Matt Black shown)
- Ideal for openings 32" - 34" wide
- Unique barn door style hardware enables door to slide parallel to wall
- Available in three finishes
- Factory finished, ready-to-install
- Custom door sizes are not available
- See pages 6 and 7 for frame, glass and panel insert options

Safety Backing - Conforms to CGSB 12.5-M86 Type 3C (Canada) and ANSI Z97.1-1984 (US)

Hardware Finishes Available



Matt Black



Stainless Steel



Bronze



BD101K Bronze Barn Door Hardware shown with Solid Pine Door



BD102K Matt Black Hardware shown with 3408 KD "Z" Frame Barn Door



BD102K Matt Black Hardware shown with 3410 "K" Frame Barn Door



BD102K Matt Black Hardware shown with Hollow Core Barn Door



ES03 Steel Frameless Series Bypass Mirror Closet Door System



Cross Sectional

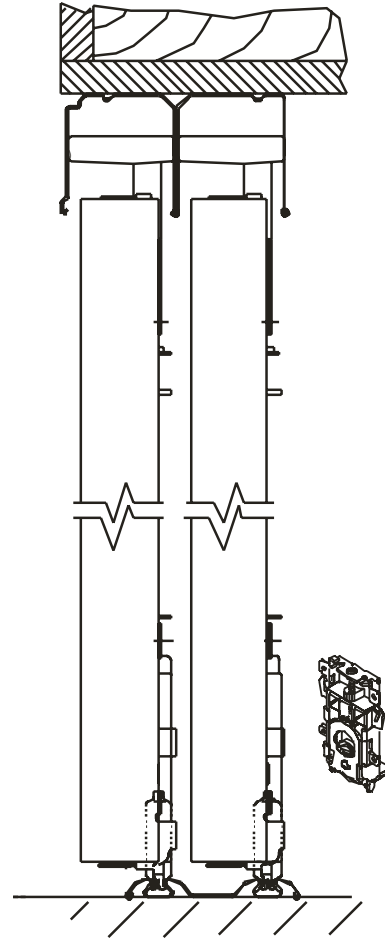

Product Description

- Edgeguard frame and mirror with polished edges
- Bottom roll with top "E" channel
- Anti-jump bottom rollers
- Standard sizes fit 4', 5', 6' widths and finished opening heights of 79-3/4" - 80-3/4" and 95-3/4" - 96-3/4" (+/- 1/4" adjustment)
- Factory finished, ready-to-install
- Custom sizes made to order
- See pages 6 and 7 for frame, glass and panel insert options

Safety Backing - Conforms to CGSB 12.5-M86 Type 3C (Canada) and ANSI Z97.1-1984 (US)

ES20 Steel Frameless Series Bypass Mirror Closet Door System



Cross Sectional

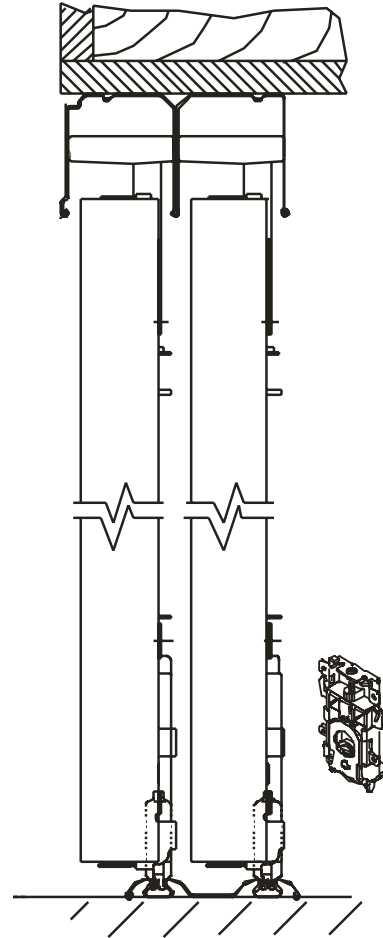

Product Description

- Edgeguard frame and mirror with 1" beveled edges
- Bottom roll with top "E" channel
- Anti-jump bottom rollers
- Standard sizes fit 4', 5', 6' widths and finished opening heights of 79-3/4" - 80-3/4" and 95-3/4" - 96-3/4" (+/- 1/4" adjustment)
- Factory finished, ready-to-install
- Custom sizes made to order
- See pages 6 and 7 for frame, glass and panel insert options

Safety Backing - Conforms to CGSB 12.5-M86 Type 3C (Canada) and ANSI Z97.1-1984 (US)

ES07 Steel Frameless Series Bifold Mirror Closet Door System



Cross Sectional

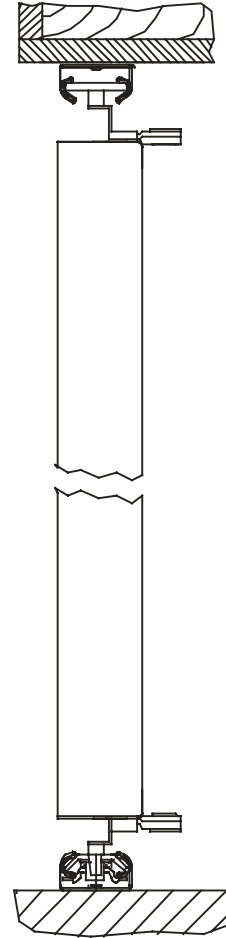

Product Description

- Edgeguard frame and mirror with 1/2" beveled edges
- Provides complete closet access
- Standard sizes fit 24", 30", 36" widths and finished opening heights of 80" - 80-3/4" and 95-1/2" - 96-1/4" (+/- 1/4" adjustment)
- Factory finished, ready-to-install
- Custom sizes made to order
- See pages 6 and 7 for frame, glass and panel insert options

Safety Backing - Conforms to CGSB 12.5-M86 Type 3C (Canada) and ANSI Z97.1-1984 (US)

ES08 Steel Frameless Series Bifold Mirror Closet Door System



Cross Sectional

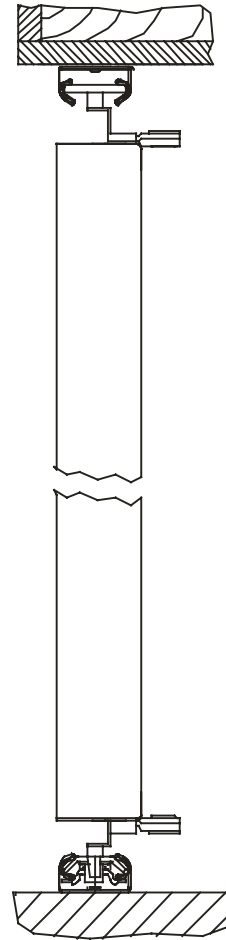

Product Description

- Edgeguard frame and mirror with polished edges
- Provides complete closet access
- Standard sizes fit 24", 30", 36" widths and finished opening heights of 80" - 80-3/4" and 95-1/2" - 96-3/4"
- Factory finished, ready-to-install
- Custom sizes made to order
- See pages 6 and 7 for frame, glass and panel insert options

Safety Backing - Conforms to CGSB 12.5-M86 Type 3C (Canada) and ANSI Z97.1-1984 (US)

ES13 Steel Frameless Series Pivot Mirror Door System



Cross Sectional

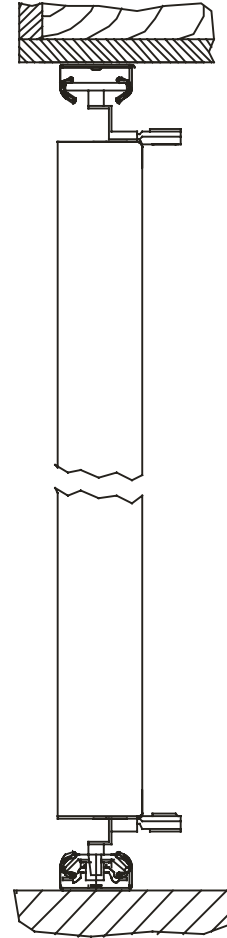

Product Description

- Edgeguard frame and mirror with polished edges
- Provides complete closet access
- Standard sizes fit 24", 30", 36" widths and finished opening heights of 80" - 80-3/4" and 95-1/2" - 96-1/4"
- Factory finished, ready-to-install
- Custom sizes made to order
- See pages 6 and 7 for frame, glass and panel insert options

Safety Backing - Conforms to CGSB 12.5-M86 Type 3C (Canada) and ANSI Z97.1-1984 (US)

ES16 Steel Framed Series Bypass Marker Board Insert Closet Door System



Cross Sectional

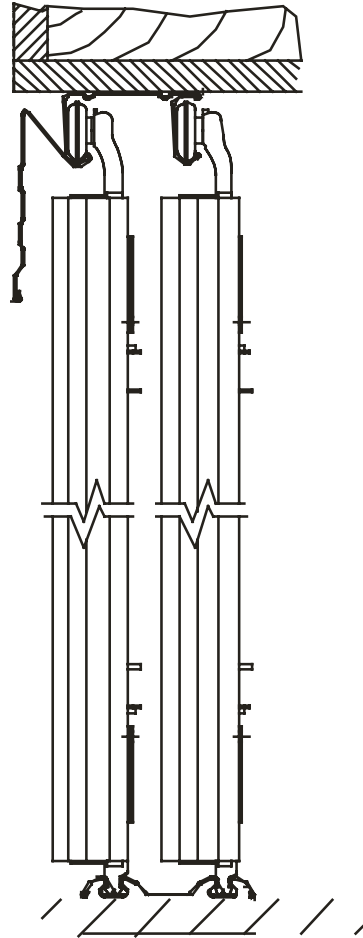

Product Description

- Top roll system with bottom track
- Anti-jump bottom guide
- 3" decorative fascia
- 3mm panel white (felt tip) marker board insert
- Standard sizes fit 4', 5', 6' widths and finished opening heights of 79-3/4" - 81" and 95-3/4" - 96-1/2" (+/- 1/4" adjustment)
- Factory finished, ready-to-install
- Custom sizes made to order
- See pages 6 and 7 for frame, glass and panel insert options

ES11 Steel Framed Series Bypass Panel Insert Closet Door System



Cross Sectional

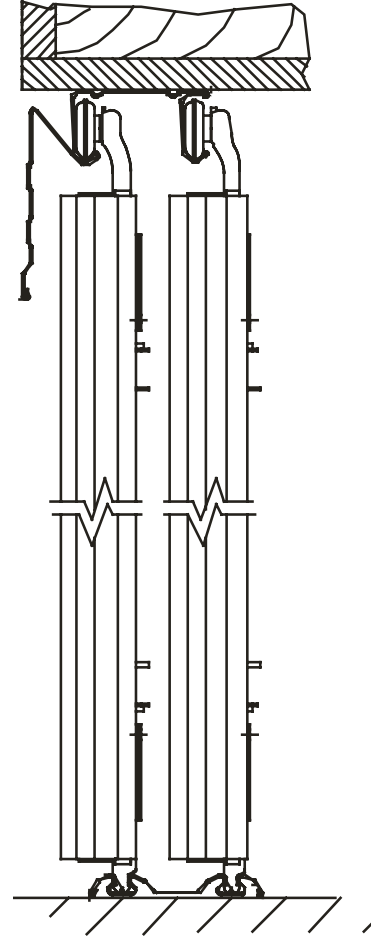

Product Description

- Top roll system with bottom track
- 3" decorative fascia
- 3mm flush panel embossed and water based painted insert
- Standard sizes fit 4', 5', 6' widths and finished opening heights of 79-3/4" - 81" and 95-3/4" - 96-1/2" (+/- 1/4" adjustment)
- Factory finished, ready-to-install
- Custom sizes made to order
- See pages 6 and 7 for frame, glass and panel insert options

ES04 Steel Framed Series Bypass Panel Insert Closet Door System



Cross Sectional

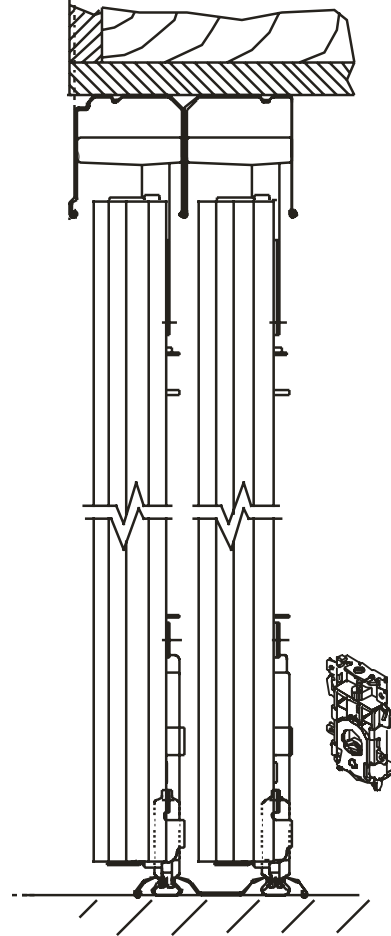

Product Description

- Bottom roll with top guide "E" channel
- Anti-jump bottom rollers
- 3mm flush panel insert
- Standard sizes fit 4', 5', 6' widths and finished opening heights of 79-3/4" - 80-3/4" and 95-3/4" - 96-3/4" (+/- 1/4" adjustment)
- Factory finished, ready-to-install
- Custom sizes made to order
- See pages 6 and 7 for frame, glass and panel insert options

ES19 Steel Framed Series Bypass Panel Insert Closet Door System



Cross Sectional

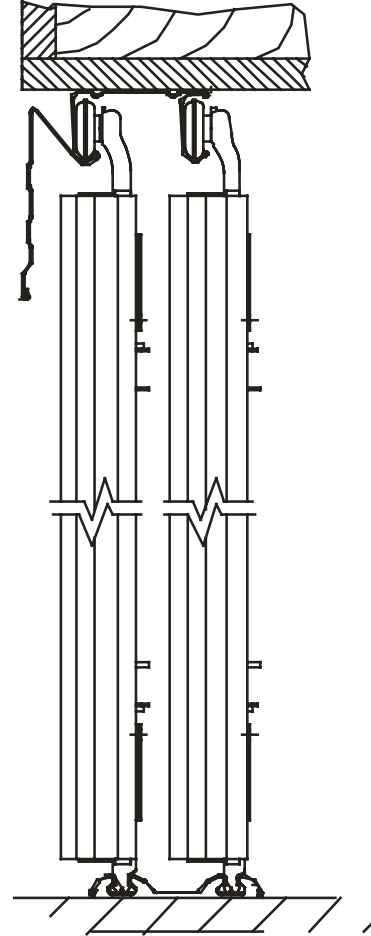

Product Description

- Top roll with matching panel and frame
- 3mm decorative fascia
- 3mm flush panel insert
- Standard sizes fit 4', 5', 6' widths and finished opening heights of 79-3/4" - 81" and 95-3/4" - 96-1/2" (+/- 1/4" adjustment)
- Factory finished, ready-to-install
- Custom sizes made to order
- See pages 6 and 7 for frame, glass and panel insert options

ES23 Steel Framed Series Bypass Closet Door System



Cross Sectional

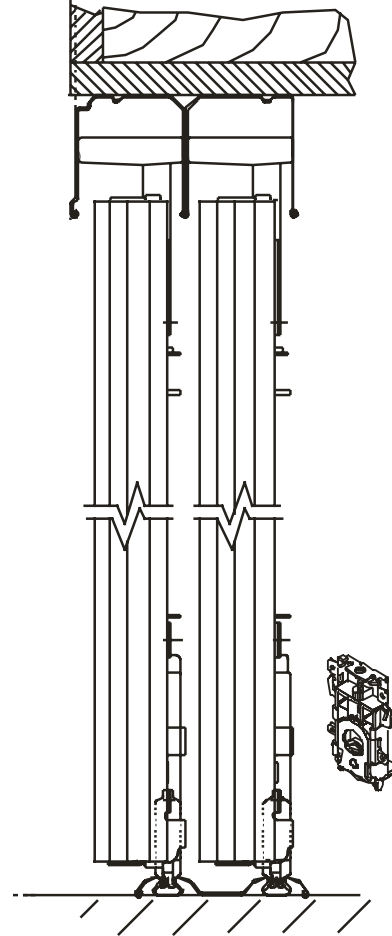

Product Description

- Bottom roll with top guide "E" channel
- Anti-jump bottom rollers
- Standard sizes fit 4', 5', 6' widths and finished opening heights of 79-3/4" - 80-3/4" and 95-3/4" - 96-3/4" (+/- 1/4" adjustment)
- Factory finished, ready-to-install
- Custom sizes made to order
- See pages 6 and 7 for frame, glass and panel insert options

Safety Backing - Conforms to CGSB 12.5-M86 Type 3C (Canada) and ANSI Z97.1-1984 (US)

ES01 Steel Framed Bypass Closet Door System



Cross Sectional

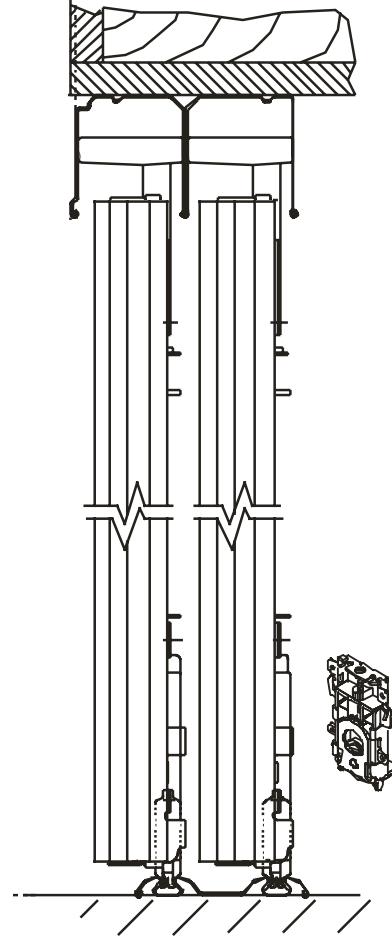

Product Description

- Bottom roll system with built in anti-jump feature
- Standard sizes fit 4', 5', 6' widths and finished opening heights of 79-3/4" - 80-3/4" and 95-3/4" - 96-3/4" (+/- 1/4" adjustment)
- Factory finished, ready-to-install
- Custom sizes made to order
- See pages 6 and 7 for frame, glass and panel insert options

Safety Backing - Conforms to CGSB 12.5-M86 Type 3C (Canada) and ANSI Z97.1-1984 (US)



ES10 Steel Framed Series Bypass Closet Door System



Cross Sectional

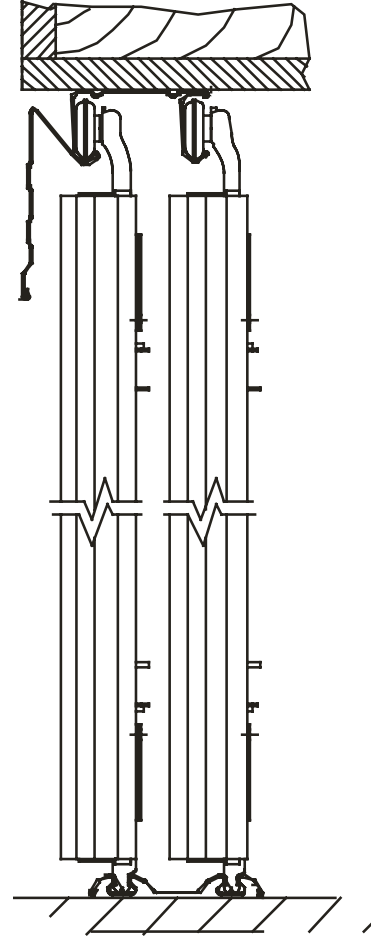

Product Description

- Top roll with 3" decorative fascia and anti-jump bottom guide
- Standard sizes fit 4', 5', 6' widths and finished opening heights of 79-3/4" - 81" (+/- 1/4" adjustment)
- Factory finished, ready-to-install
- Custom sizes made to order
- See pages 6 and 7 for frame, glass and panel insert options

Safety Backing - Conforms to CGSB 12.5-M86 Type 3C (Canada) and ANSI Z97.1-1984 (US)



ES09 Steel Framed Series Bypass Molded Panel Insert Closet Door System



Cross Sectional

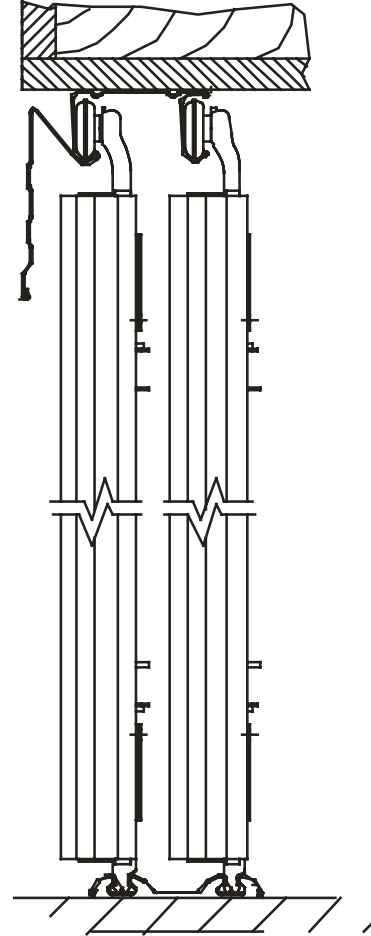

Product Description

- Embossed 6 panel door pre-finished white (P.F.W)
- Squared top panels design
- Top roll system with 3" decorative fascia
- Standard sizes fit 4', 5', 6' widths and finished opening heights of 79-3/4" - 81" (+/- 1/4" adjustment)
- 95-3/4" - 96-1/2" (+/- 1/4" adjustment) doors also available
- Factory finished, ready-to-install
- Due to the nature of embossed panel, custom sizes are not available
- See pages 6 and 7 for frame, glass and panel insert options

ES105 Steel Framed Series Bypass Molded Panel Insert Closet Door System



Cross Sectional

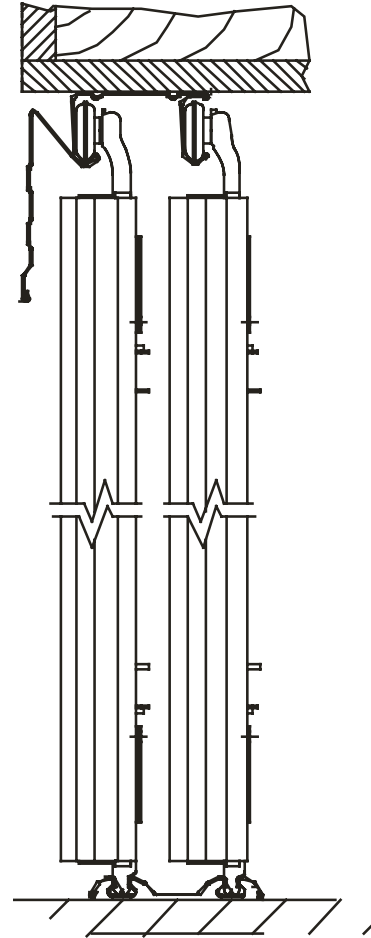

Product Description

- Embossed 2 panel smooth door primed, ready to finish (R.T.F)
- Curved top panel design
- Top roll with 3" decorative fascia
- Standard sizes fit 4', 5', 6' widths and finished opening heights of 79-3/4" - 81" (+/- 1/4" adjustment)
- 95-3/4" - 96-1/2" (+/- 1/4" adjustment) doors also available
- Factory finished, ready-to-install
- Due to the nature of embossed panel, custom sizes are not available
- See pages 6 and 7 for frame, glass and panel insert options

ES41 Steel Framed Series Bypass Molded Panel Insert Closet Door System



Cross Sectional

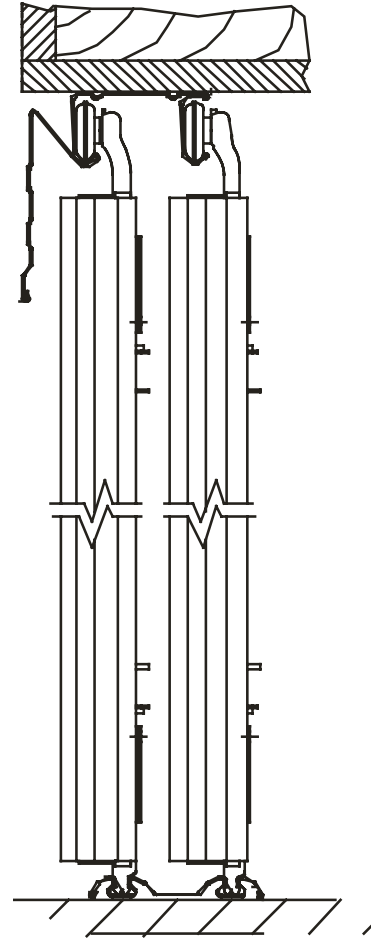

Product Description

- Embossed 2 panel lined door primed, ready to finish (R.T.F)
- Striped decorative detail with curved top panel design
- Top roll system with 3" decorative fascia
- Standard sizes fit 4', 5', 6' widths and finished opening heights of 79-3/4" - 81" (+/- 1/4" adjustment)
- 95-3/4" - 96-1/2" (+/- 1/4" adjustment) doors also available
- Factory finished, ready-to-install
- Due to the nature of embossed panel, custom sizes are not available
- See pages 6 and 7 for frame, glass and panel insert options

ES42 Steel Framed Series Bypass Molded Panel Insert Closet Door System



Cross Sectional

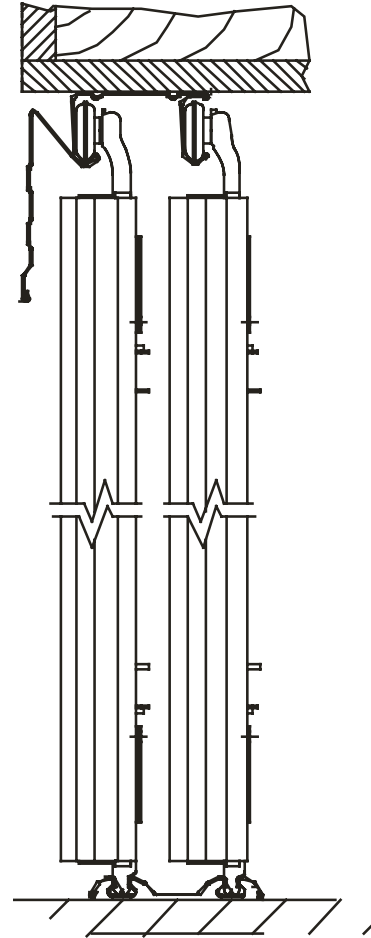

Product Description

- Embossed 2 panel smooth door primed, ready to finish (R.T.F)
- Squared top panel design
- Top roll with 3" decorative fascia
- Standard sizes fit 4', 5', 6' widths and finished opening heights of 79-3/4" - 81" (+/- 1/4" adjustment)
- 95-3/4" - 96-1/2" (+/- 1/4" adjustment) doors also available
- Factory finished, ready-to-install
- Due to the nature of embossed panel, custom sizes are not available
- See pages 6 and 7 for frame, glass and panel insert options

ES43 Steel Framed Series Bypass Molded Panel Insert Closet Door System



Cross Sectional

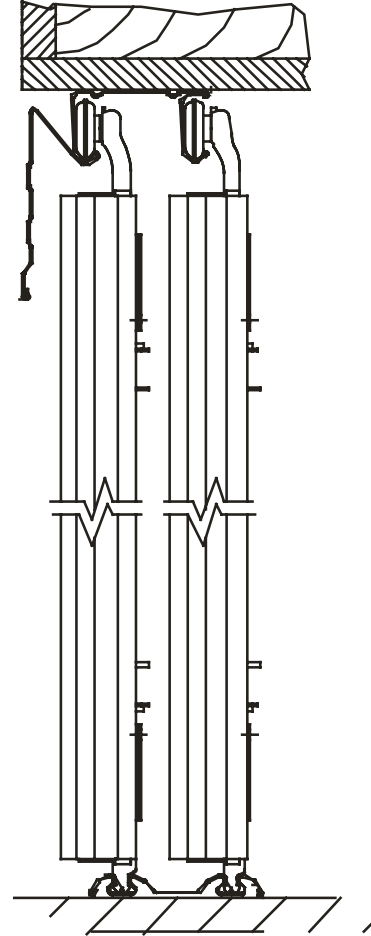

Product Description

- Embossed 2 panel smooth door primed, ready to finish (R.T.F)
- Arched top panel design
- Top roll with 3" decorative fascia
- Standard sizes fit 4', 5', 6' widths and finished opening heights of 79-3/4" - 81" (+/- 1/4" adjustment)
- 95-3/4" - 96-1/2" (+/- 1/4" adjustment) doors also available
- Factory finished, ready-to-install
- Due to the nature of embossed panel, custom sizes are not available
- See pages 6 and 7 for frame, glass and panel insert options

ES27 Steel Framed Wide Stile Series Bypass Closet Door System

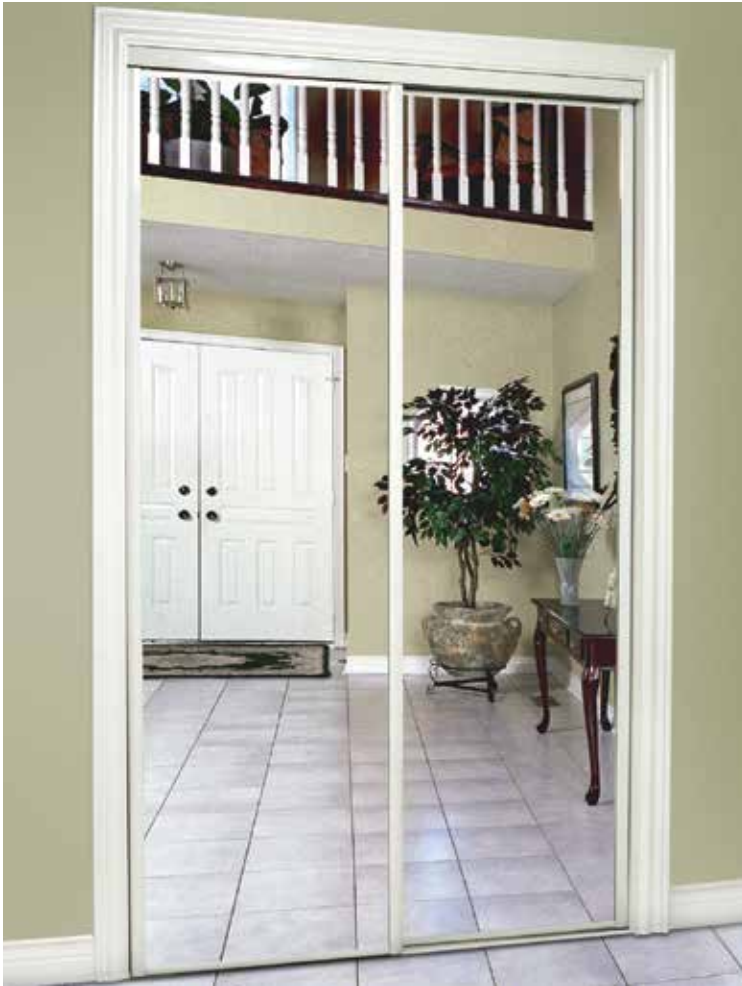

Cross Sectional

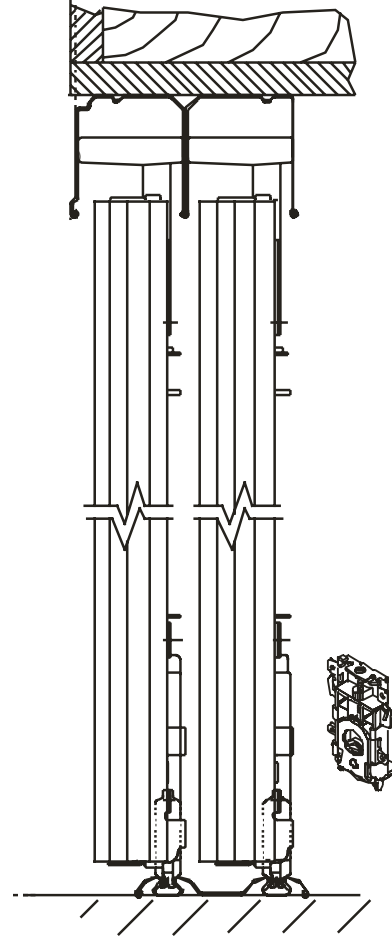

Product Description

- Bottom roll with top guide "E" channel
- Anti-jump bottom rollers
- Standard sizes fit 4', 5', 6' widths and finished opening heights of 79-3/4" - 80-3/4" and 95-3/4" - 96-3/4" (+/- 1/4" adjustment)
- Factory finished, ready-to-install
- Custom sizes made to order
- See pages 6 and 7 for frame, glass and panel insert options

Safety Backing - Conforms to CGSB 12.5-M86 Type 3C (Canada) and ANSI Z97.1-1984 (US)

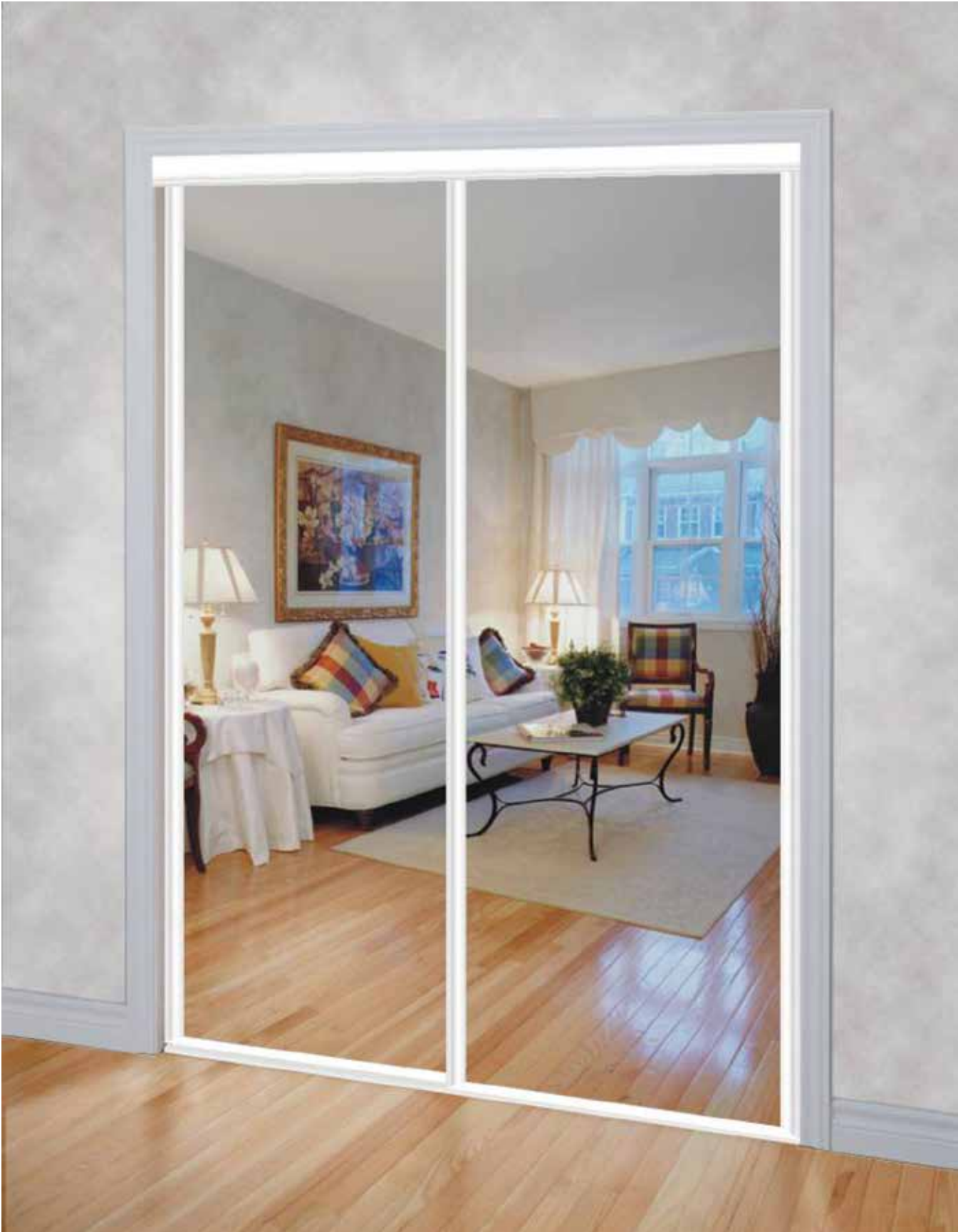

ES27 STEEL FRAMED BYPASS DOORS

ES28 Steel Framed Wide Stile Series Bypass Closet Door System



Cross Sectional

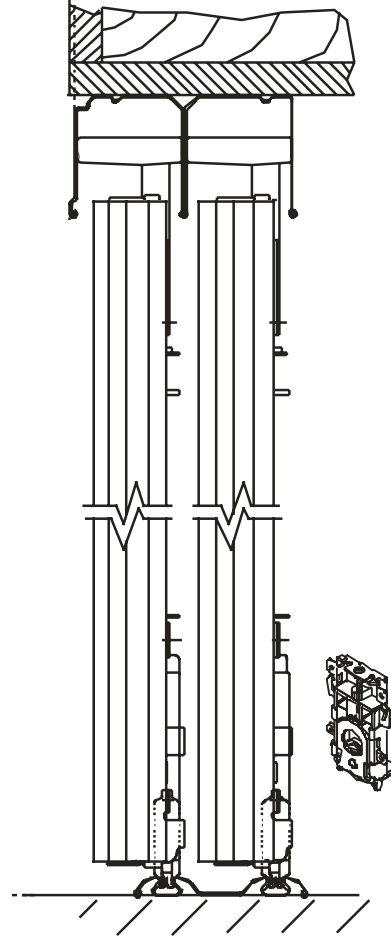

Product Description

- Wide stile laminated frame
- Bottom roll with top guide "E" channel
- Anti-jump bottom rollers
- Standard sizes fit 4', 5', 6' widths and finished opening heights of 79-3/4" - 80-3/4" and 95-3/4" - 96-3/4" (+/- 1/4" adjustment)
- Factory finished, ready-to-install
- Custom sizes made to order
- See pages 6 and 7 for frame, glass and panel insert options

Safety Backing - Conforms to CGSB 12.5-M86 Type 3C (Canada) and ANSI Z97.1-1984 (US)

ES29 Steel Framed Wide Stile Series Bypass Panel Closet Door System



Cross Sectional

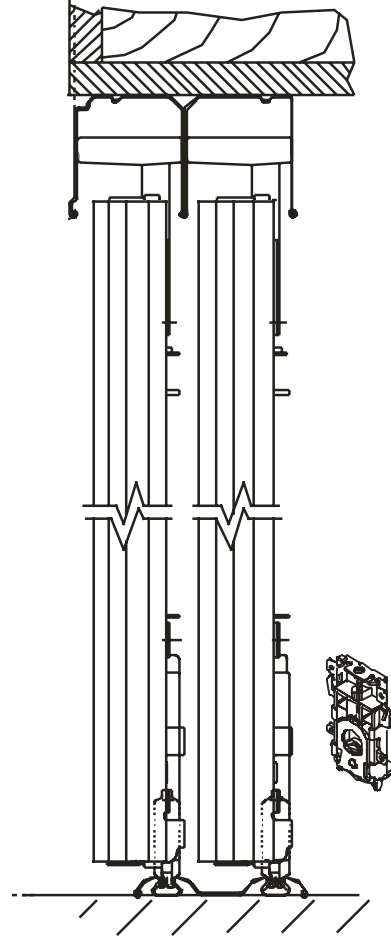

Product Description

- Laminated frame matches 3mm flush panel insert finish
- Bottom roll with top guide "E" channel
- Anti-jump bottom rollers
- Standard sizes fit 4', 5', 6' widths and finished opening heights of 79-3/4" - 80-3/4" and 95-3/4" - 96-3/4" (+/- 1/4" adjustment)
- Factory finished, ready-to-install
- Custom sizes made to order
- See pages 6 and 7 for frame, glass and panel insert options

ES06 Steel Framed Series Bifold Closet Door System



Cross Sectional

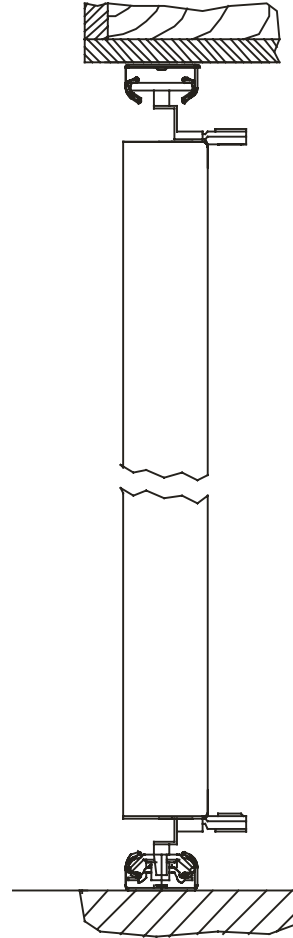

Product Description

- Provides complete closet access
- Slimline frame
- Standard sizes fit 24", 30", 36" widths and finished opening heights of 80" - 80-3/4" and 95-1/2" - 96-1/4"
- Factory finished, ready-to-install
- Custom sizes made to order
- See pages 6 and 7 for frame, glass and panel insert options

Safety Backing - Conforms to CGSB 12.5-M86 Type 3C (Canada) and ANSI Z97.1-1984 (US)

ES12 Steel Framed Series Pivot Mirror Door System



Cross Sectional

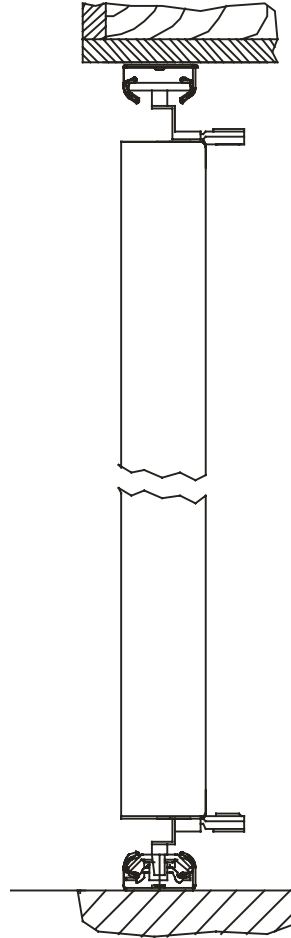

Product Description

- Provides complete closet or room access
- Standard sizes fit 24", 30", 36" widths and finished opening heights of 80" - 80-3/4" and 95-1/2" - 96-1/4"
- Factory finished, ready-to-install
- Custom sizes made to order
- See pages 6 and 7 for frame, glass and panel insert options

Safety Backing - Conforms to CGSB 12.5-M86 Type 3C (Canada) and ANSI Z97.1-1984 (US)

ES15 Steel Framed Series Pivot Panel Door System



Cross Sectional

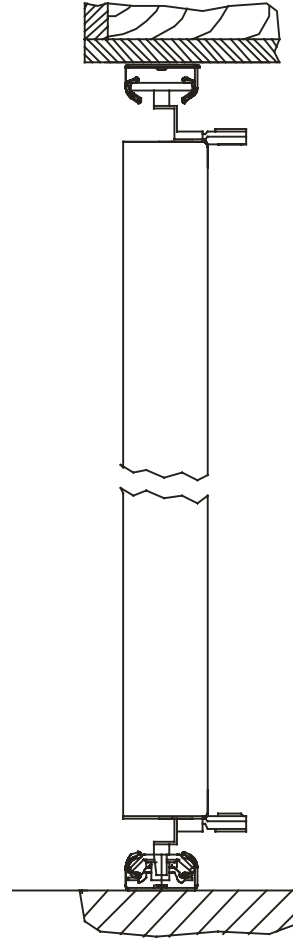

Product Description

- Provides complete closet or room access
- Standard sizes fit 24", 30", 36" widths and finished opening heights of 80" - 80-3/4" and 95-1/2" - 96-1/4"
- Factory finished, ready-to-install
- Custom sizes made to order
- See pages 6 and 7 for frame, glass and panel insert options

ES30 Aluminum Frameless Series Bypass Mirror Closet Door System



Cross Sectional

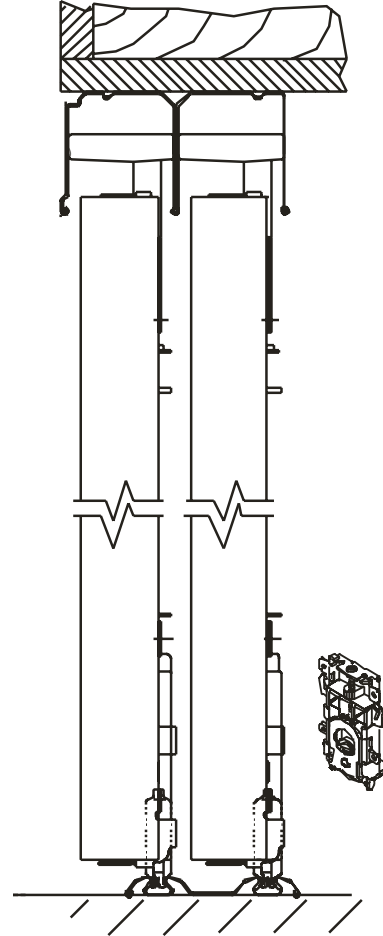

Product Description

- Bottom roll with top guide "E" channel
- Anti-jump bottom rollers
- Edgeguard frame and mirror with 1" beveled edges
- Standard sizes fit 4', 5', 6' widths and finished opening heights of 79-3/4" - 80-1/2" and 95-3/4" - 96-1/2" (+/- 1/4" adjustment)
- Factory finished, ready-to-install
- Custom sizes made to order
- See pages 6 and 7 for frame, glass and panel insert options

Safety Backing - Conforms to CGSB 12.5-M86 Type 3C (Canada) and ANSI Z97.1-1984 (US)

ES33 Aluminum Frameless Series Bypass Mirror Closet Door System



Cross Sectional

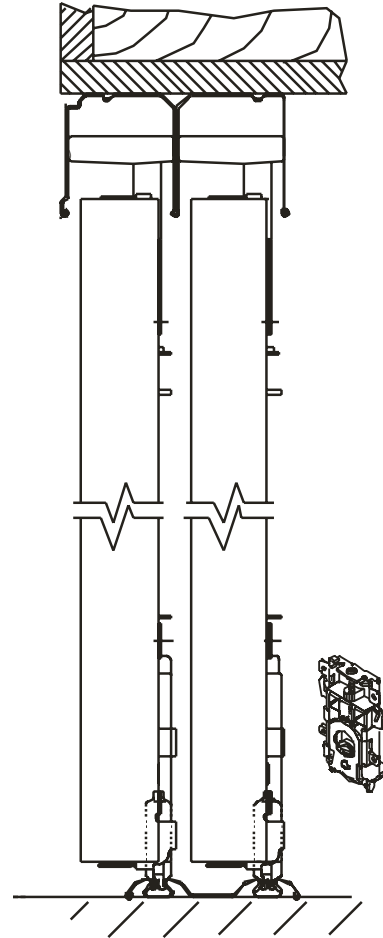

Product Description

- Bottom roll with top guide "E" channel
- Anti-jump bottom rollers
- Edgeguard frame and mirror with polished edges
- Standard sizes fit 4', 5', 6' widths and finished opening heights of 79-3/4" - 80-3/4" and 95-3/4" - 96-3/4" (+/- 1/4" adjustment)
- Factory finished, ready-to-install
- Custom sizes made to order
- See pages 6 and 7 for frame, glass and panel insert options

Safety Backing - Conforms to CGSB 12.5-M86 Type 3C (Canada) and ANSI Z97.1-1984 (US)

ES32 Aluminum Frameless Series Bypass Mirror Closet Door System



Cross Sectional

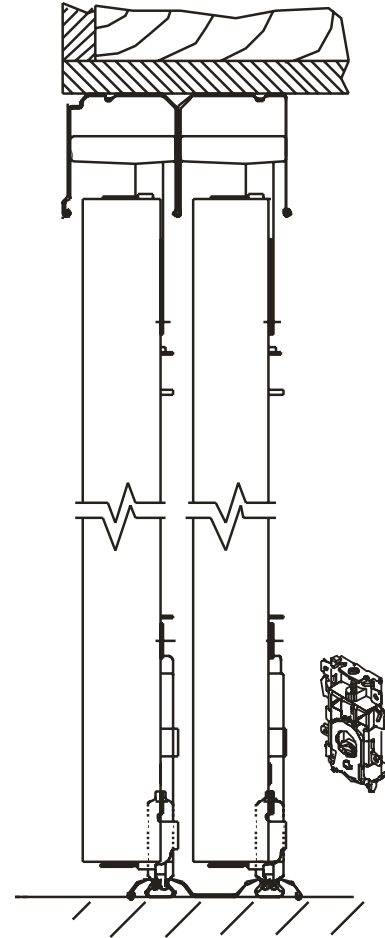

Product Description

- Bottom roll with top guide "E" channel
- Anti-jump bottom rollers
- Edgeguard frame and mirror with 1/2" beveled edges
- Standard sizes fit 4', 5', 6' widths and finished opening heights of 79-3/4" - 80-3/4" and 95-3/4" - 96-3/4" (+/- 1/4" adjustment)
- Factory finished, ready-to-install
- Custom sizes made to order
- See pages 6 and 7 for frame, glass and panel insert options

Safety Backing - Conforms to CGSB 12.5-M86 Type 3C (Canada) and ANSI Z97.1-1984 (US)

ES37 Aluminum Frameless Series Bifold Mirror Closet Door System



Cross Sectional

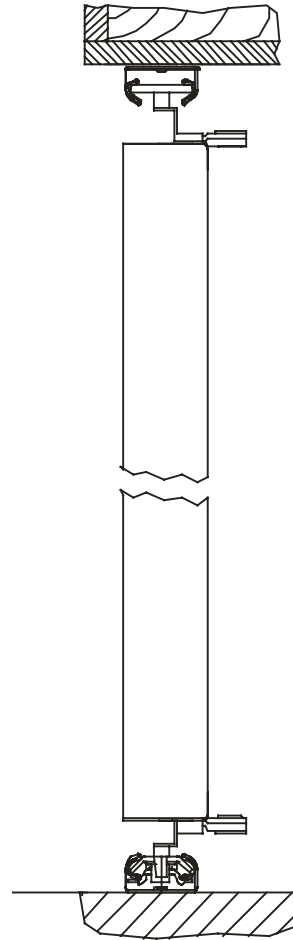

Product Description

- Provides complete closet access
- Edgeguard frame and mirror with 1/2" beveled edges
- Standard sizes fit 24", 30", 36" widths and finished opening heights of 80" - 80-3/4" and 95-1/2" - 96-1/4"
- Factory finished, ready-to-install
- Custom sizes made to order
- See pages 6 and 7 for frame, glass and panel insert options

Safety Backing - Conforms to CGSB 12.5-M86 Type 3C (Canada) and ANSI Z97.1-1984 (US)

ES38 Aluminum Frameless Series Bifold Mirror Closet Door System



Cross Sectional

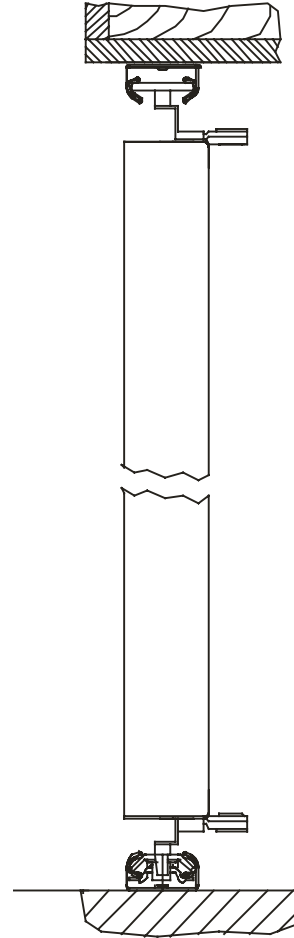

Product Description

- Edgeguard frame and mirror with polished edges
- Adjust-ability of +1/4" to -0" on width
- Standard sizes fit 24", 30", 36" widths and finished opening heights of 80" - 80-3/4" and 95-1/2" - 96-1/4"
- Factory finished, ready-to-install
- Custom sizes made to order
- See pages 6 and 7 for frame, glass and panel insert options

Safety Backing - Conforms to CGSB 12.5-M86 Type 3C (Canada) and ANSI Z97.1-1984 (US)



ES31 Aluminum Framed Series Bypass Mirror Closet Door System

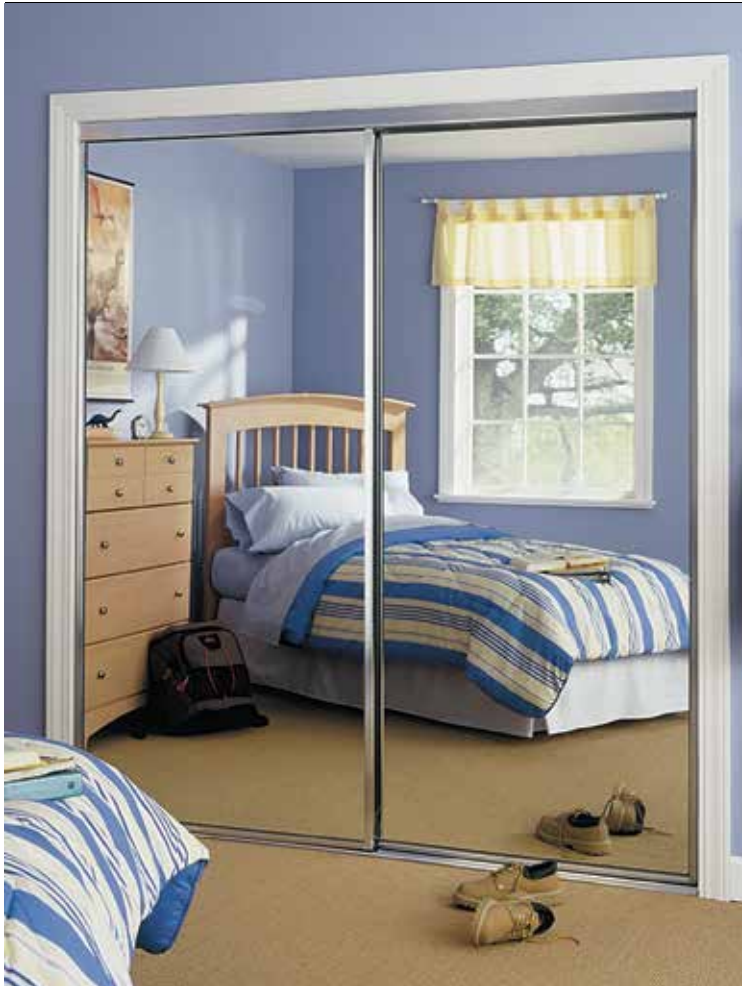

Cross Sectional

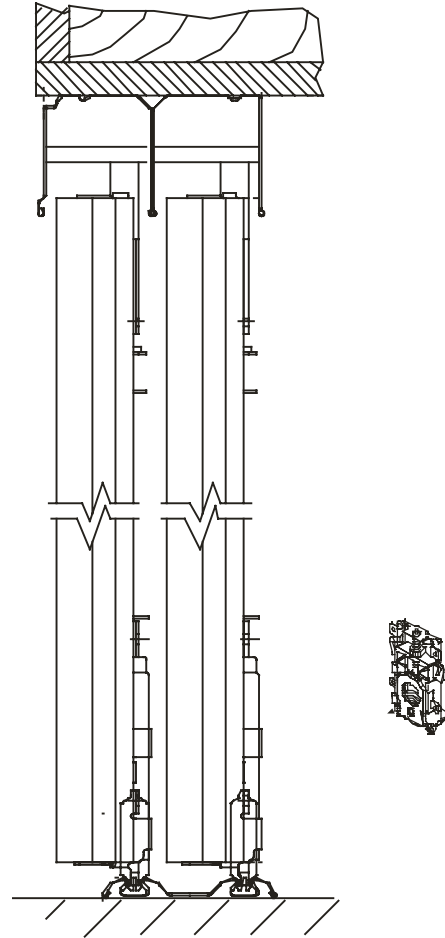

Product Description

- Bottom roll with top guide "E" channel
- Anti-jump bottom rollers
- Standard sizes fit 4', 5', 6' widths and finished opening heights of 79-3/4" - 80-3/4" and 95-3/4" - 96-3/4" (+/- 1/4" adjustment)
- Factory finished, ready-to-install
- Custom sizes made to order
- See pages 6 and 7 for frame, glass and panel insert options

Safety Backing - Conforms to CGSB 12.5-M86 Type 3C (Canada) and ANSI Z97.1-1984 (US)

ES35 Aluminum Wide Stile Framed Series Bypass Mirror Closet Door System



Cross Sectional

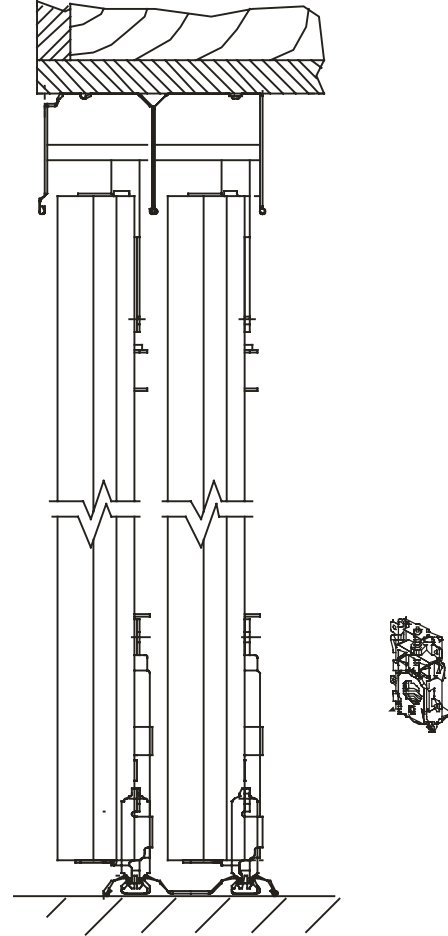

Product Description

- Bottom roll with top guide "E" channel
- Anti-jump bottom rollers
- Standard sizes fit 4', 5', 6' widths and finished opening heights of 79-3/4" - 80-3/4" and 95-3/4" - 96-3/4" (+/- 1/4" adjustment)
- Factory finished, ready-to-install
- Custom sizes made to order
- See pages 6 and 7 for frame, glass and panel insert options

Safety Backing - Conforms to CGSB 12.5-M86 Type 3C (Canada) and ANSI Z97.1-1984 (US)

ES36 Aluminum Framed Series Bifold Mirror Closet Door System



Cross Sectional

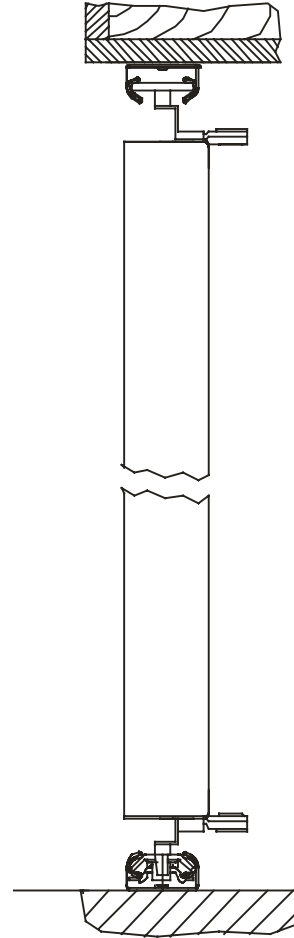

Product Description

- Provides complete closet access
- Slimline frame
- Adjust-ability of +1/4" to -0" on width
- Standard sizes fit 24", 30", 36" widths and finished opening heights of 80" - 80-3/4" and 95-1/2" - 96-1/4"
- Factory finished, ready-to-install
- Custom sizes made to order
- See pages 6 and 7 for frame, glass and panel insert options

Safety Backing - Conforms to CGSB 12.5-M86 Type 3C (Canada) and ANSI Z97.1-1984 (US)

ES	Series	Model	Category	Description
ES94	N/A	N/A	1 Inch Aluminum	Swing Mirror Door System
N/A	4100	N/A	1 Inch Aluminum	Overlay Mirror Door System
N/A	7042	N/A	2 Inch Aluminum	Bypass Closet Door System
ES68	7041	N/A	2 Inch Aluminum	Sliding Wall Mounted Room Divider Door System
ES66	7046	N/A	3 Inch Aluminum	Sliding Wall Mounted Room Divider Door System
ES67	7039	N/A	2 Inch Aluminum	Bypass Ceiling Mounted Room Divider Door System
N/A	7053	N/A	3 Inch Aluminum	Bypass Ceiling Mounted Room Divider Door System
ES70	7017	N/A	Extruded Aluminum	Bypass Ceiling Mounted Room Divider Door System
ES70	7017	N/A	Extruded Aluminum	Bypass Door System
ES90-18	2400	2000	Euro Cherry Wood	1 Lite Bypass Closet Door System
ES90-18	2400	2010	Euro White Wood	1 Lite Bypass Closet Door System
ES90-18	2400	2230	Euro Espresso Wood	1 Lite Bypass Closet Door System
ES90-38	2401	2310	Euro Cherry Wood	3 Lite Bypass Closet Door System
ES90-38	2401	2030	Euro White Wood	3 Lite Bypass Closet Door System
ES90-38	2401	2290	Euro Espresso Wood	3 Lite Bypass Closet Door System
ES90-58	2402	2240	Euro Espresso Wood	5 Lite Bypass Closet Door System
ES91-18	4401	3030	Euro White Wood	1 Lite Bifold Closet Door System
ES91-18	4401	3010	Euro Espresso Wood	1 Lite Bifold Closet Door System
ES91-38	4402	3100	Euro White Wood	3 Lite Bifold Closet Door System
ES91-38	4402	3080	Euro Espresso Wood	3 Lite Bifold Closet Door System
ES93-18	5401	N/A	Euro White Wood	1 Lite Pivot Door System
ES93-18	5401	N/A	Euro Espresso Wood	1 Lite Pivot Door System
ES98-38	5402	N/A	Euro White Wood	3 Lite Pivot Door System
ES98-38	5402	N/A	Euro Espresso Wood	3 Lite Pivot Door System
N/A	3407	N/A	Wood Pine Barn Door	1 Lite Straight Strap Wall Mounted Barn Door Kit System
N/A	3407	N/A	Wood Pine Barn Door	1 Lite Top of Door Wall Mounted Barn Door Kit System
N/A	3407	N/A	Wood Pine Barn Door	1 Lite Bent Strap Wall Mounted Barn Door Kit System
ES03	2024	325P (M03)	Steel Frameless	Bypass Mirror Closet Door System
ES20	2025	M20	Steel Frameless	Bypass Mirror Closet Door System
ES07	4008	321B (M07)	Steel Frameless	Bifold Mirror Closet Door System
ES08	4002	321P (M08)	Steel Frameless	Bifold Mirror Closet Door System
ES13	5514	M13	Steel Frameless	Pivot Mirror Door System
ES16	2014	M16	Steel Framed	Bypass Marker Board Insert Closet Door System
ES11	2013	100 (M11)	Steel Framed	Bypass Panel Insert Closet Door System
ES04	2303	M04	Steel Framed	Bypass Panel Insert Closet Door System
ES19	2026	M19	Steel Framed	Bypass Panel Insert Closet Door System

ES	Series	Model	Category	Description
ES23	2043	230	Steel Framed	Bypass Closet Door System
ES01	2003	220 (M01)	Steel Framed	Bypass Closet Door System
ES10	2002	120 (M10)	Steel Framed	Bypass Mirror Closet Door System
ES09	2006	106 (M09)	Steel Framed	Bypass Molded Panel Insert Closet Door System
ES105	N/A	105	Steel Framed	Bypass Molded Panel Insert Closet Door System
ES41	2010	107 (M41)	Steel Framed	Bypass Molded Panel Insert Closet Door System
ES42	2011	108 (M42)	Steel Framed	Bypass Molded Panel Insert Closet Door System
ES43	2012	109 (M43)	Steel Framed	Bypass Molded Panel Insert Closet Door System
ES27	2009	M27	Steel Framed Wide Stile	Bypass Closet Door System
ES28	2023	M28	Steel Framed Wide Stile	Bypass Closet Door System
ES29	2028	M29	Steel Framed Wide Stile	Bypass Panel Insert Closet Door System
ES06	4006	221 (M06)	Steel Framed	Bifold Mirror Closet Door System
ES12	5513	M12	Steel Framed	Pivot Mirror Door System
ES15	5810	M15	Steel Framed	Pivot Panel Insert Door System
ES30	7030	350 (M30)	Aluminum Frameless	Bypass Mirror Closet Door System
ES33	7033	M33	Aluminum Frameless	Bypass Mirror Closet Door System
ES32	7032	M32	Aluminum Frameless	Bypass Mirror Closet Door System
ES37	7402	351 (M37)	Aluminum Frameless	Bifold Mirror Closet Door System
ES38	7403	351P (M38)	Aluminum Frameless	Bifold Mirror Closet Door System
ES31	7003	250 (M31)	Aluminum Framed	Bypass Mirror Closet Door System
ES35	7025	M35	Aluminum Framed Wide Stile	Bypass Mirror Closet Door System
ES36	7401	M36	Aluminum Framed	Bifold Mirror Closet Door System

WARRANTY TERMS

5 YEAR LIMITED WARRANTY. Renin warrants all components & hardware for its sliding, bypass, bifold, pivot and overlay doors against defects in workmanship and materials subject to ordinary wear and tear, for the limited life of these products. This includes mirror door frame components, top tracks, top guides, bottom rollers, pivot hardware and hinges. Further, Renin warrants all safety backed mirror against defects in material and workmanship for a period of five (5) years from the date of purchase. This warranty shall not apply if damages are due to abuse, mishandling, improper installation or use; incidental or coincidental water and/or moisture exposure or foreign matter which includes drippings from ceiling materials or paint; or materials placed on the back or edges of product by others; or mirror failure which includes black edge, discoloration and slight hardware rusting when installed within five (5) miles of salt water.

1 YEAR LIMITED WARRANTY. Renin warrants all components & hardware for its barn door kits against defects in workmanship and materials subject to ordinary wear and tear, for the limited life of these products. This includes all hardware components of rail, spacers, anti-jump blocks, straps, stoppers, installation screws / bolts and door guides for a period of one (1) year. This warranty shall not apply if damages are due to abuse, mishandling, improper installation or use; incidental or coincidental water and/or moisture exposure or foreign matter which includes drippings from ceiling materials or paint; or materials placed on the back or edges of product by others; discoloration and slight hardware rusting when installed within five (5) miles of salt water.

Either warranty does not extend to any labor charges incurred in the removal, re-installation or replacement of any defective products or parts thereof. In the event of a defect, malfunction or other failure of the product to which this warranty applies, Renin will remedy the failure or defect, without charge to the consumer within thirty (30) days from the actual receipt of the product, or refund of the purchase price at Renin's discretion.

To obtain performance under this warranty, the consumer should contact Renin Customer Service at 1-800-257-4093, between 8:30 am and 6:00 pm EST, Monday to Friday. This limited warranty is extended to the original purchaser only, and is non-transferable. This limited warranty is in lieu of all others including but not limited to; the implied warranty merchantability and fitness for a particular purpose and excludes all incidental or consequential damages. Should you have any questions, contact the Renin Customer Service Department at 1-800-257-4093.

110 Walker Drive, Brampton, Ontario L6T 4H6 Canada.

ORDER FORM

If ordering standard doors, please submit your ES, Series or Model Door number(s) to complete your order(s). If however you wish to customize your door(s), please specify your preferred option(s) below. Should you require any assistance or any further information, please contact your Sales Representative or Customer Service Department to help complete your Order Form.

SELECT YOUR DOOR SYSTEM TO BEST FIT YOUR FINISHED OPENING SIZE

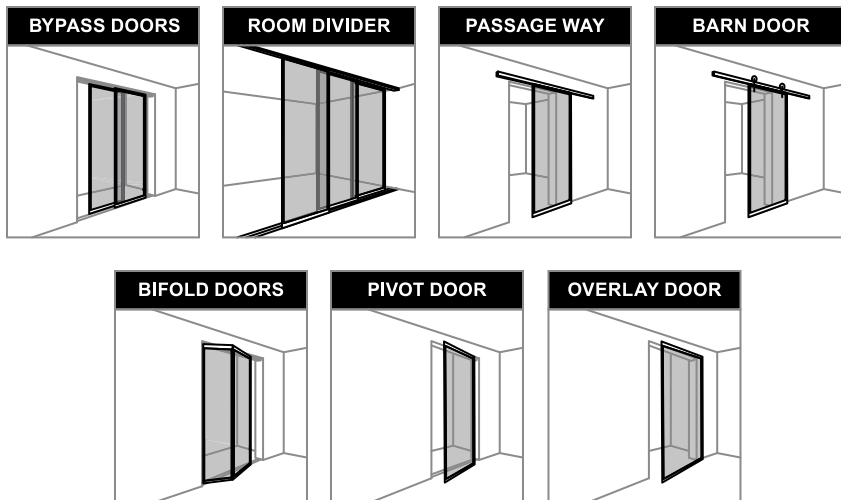

SELECT YOUR FRAMELESS OR FRAMED STILE, FINISH AND INSERT AVAILABLE BY SYSTEM

EXTRUDED ALUMINUM SWING, SLIDING & BYPASS ROOM DIVIDER DOORS

EXTRUDED ALUMINUM FRAME FINISHES AVAILABLE

- CLEAR ANODIZED ALUMINUM
 BRONZE ANODIZED ALUMINUM

ES, SERIES or MODEL NUMBER:

FINISHED OPENING SIZE:

DOOR WIDTH:

DOOR HEIGHT:

FRONT FACING INSERT:

BACK FACING INSERT:

CUSTOM GLASS INSERT OPTIONS AVAILABLE

- CLEAR MIRROR
 SMOKED MIRROR
 BRONZE MIRROR
 CLEAR LAMINATED GLASS
 OPAQUE WHITE LAMINATED GLASS
 BLACK BACK PAINTED GLASS
 WHITE BACK PAINTED GLASS
 STANDARD
 RED BACK PAINTED GLASS
 SPECIAL ORDER GLASS: _____

CUSTOM FLUSH PANEL INSERT OPTIONS AVAILABLE

- WHITE 1/8" (3mm)
 ALMOND 1/8" (3mm)
 OAK 1/8" (3mm)
 WHITEWOOD 1/8" (3mm)
 LAMINATED OAK 1/8" (3mm)
 LAMINATED MAHOGANY 1/8" (3mm)

EURO WOOD BYPASS, BIFOLD & PIVOT DOORS

EURO WOOD FRAME FINISHES AVAILABLE

- ESPRESSO (EF) CHERRY (CF)
 WHITE (WF)

ES, SERIES or MODEL NUMBER:

FINISHED OPENING SIZE:

DOOR WIDTH:

DOOR HEIGHT:

FRONT FACING INSERT:

BACK FACING INSERT:

CUSTOM GLASS INSERT OPTIONS AVAILABLE

- CLEAR MIRROR SMOKED MIRROR
 BRONZE MIRROR CLEAR LAMINATED GLASS
 OPAQUE WHITE LAMINATED GLASS BLACK BACK PAINTED GLASS
 WHITE BACK PAINTED GLASS STANDARD (FROSTED GLASS)
 RED BACK PAINTED GLASS SPECIAL ORDER GLASS: _____

WOOD SLIDING DOORS

WOOD DOOR FINISH AVAILABLE

- PRIMED PINE

BARN DOOR FINISH KIT OPTIONS

- BRONZE STEEL MATT BLACK STEEL
 STAINLESS STEEL

ES, SERIES or MODEL NUMBER:

FINISHED OPENING SIZE:

DOOR WIDTH:

DOOR HEIGHT:

FRONT FACING INSERT:

BACK FACING INSERT:

CUSTOM GLASS INSERT OPTIONS AVAILABLE

- CLEAR MIRROR SMOKED MIRROR
 BRONZE MIRROR CLEAR LAMINATED GLASS
 OPAQUE WHITE LAMINATED GLASS BLACK BACK PAINTED GLASS
 WHITE BACK PAINTED GLASS STANDARD
 RED BACK PAINTED GLASS SPECIAL ORDER GLASS: _____

CUSTOM FLUSH PANEL INSERT OPTIONS AVAILABLE

- WHITE 1/8" (3mm) ALMOND 1/8" (3mm)
 OAK 1/8" (3mm) WHITEWOOD 1/8" (3mm)
 LAMINATED OAK 1/8" (3mm) LAMINATED MAHOGANY 1/8" (3mm)

STEEL FRAMELESS OR FRAMED BYPASS, BIFOLD, PIVOT & OVERLAY DOORS

STEEL FRAMED & FRAMELESS FINISHES AVAILABLE

- SATIN GOLD (SG) ARCTIC SILVER (AS)
 BRIGHT WHITE (BW) MATT BLACK (MB)
 BRIGHT GOLD (BG) VANILLA (VA)
 ARCHITECTURAL BROWN (AB) POLISHED BRASS (PB)
 SATIN NICKEL (SN)

CUSTOM GLASS INSERT OPTIONS AVAILABLE

- CLEAR MIRROR SMOKED MIRROR
 BRONZE MIRROR CLEAR LAMINATED GLASS
 OPAQUE WHITE LAMINATED GLASS BLACK BACK PAINTED GLASS
 WHITE BACK PAINTED GLASS STANDARD
 RED BACK PAINTED GLASS SPECIAL ORDER GLASS: _____

LAMINATED STEEL FRAMED FINISHES AVAILABLE

- | | |
|--|---|
| <input type="checkbox"/> BEECH (LB) | <input type="checkbox"/> PINE (LP) |
| <input type="checkbox"/> MAHOGANY (LM) | <input type="checkbox"/> UNSTAINED OAK (UO) |
| <input type="checkbox"/> OAK (LO) | <input type="checkbox"/> PEARWOOD (PE) |
| <input type="checkbox"/> CALVADOS (CA) | <input type="checkbox"/> CHERRY (CH) |

ES, SERIES or MODEL NUMBER:

FINISHED OPENING SIZE:

DOOR WIDTH:

DOOR HEIGHT:

FRONT FACING INSERT:

BACK FACING INSERT:

CUSTOM PANEL INSERT OPTIONS AVAILABLE

- | | |
|--|---|
| <input type="checkbox"/> WHITE
1/8" (3mm) | <input type="checkbox"/> ALMOND
1/8" (3mm) |
| <input type="checkbox"/> OAK
1/8" (3mm) | <input type="checkbox"/> WHITEWOOD
1/8" (3mm) |
| <input type="checkbox"/> LAMINATED OAK
1/8" (3mm) | <input type="checkbox"/> LAMINATED MAHOGANY
1/8" (3mm) |
| <input type="checkbox"/> ANGEL WHITE
1/2" (12mm) | <input type="checkbox"/> COUNTRY PINE
1/2" (12mm) |
| <input type="checkbox"/> TRADITIONAL OAK
1/2" (12mm) | <input type="checkbox"/> MISTY GREY
1/2" (12mm) |
| <input type="checkbox"/> FORMAL BLACK
1/2" (12mm) | <input type="checkbox"/> IMPERIAL OYSTER
1/2" (12mm) |
| <input type="checkbox"/> VICTORIAM CHERRY
1/2" (12mm) | <input type="checkbox"/> LAMINATED OAK
1/2" (12mm) |
| <input type="checkbox"/> LAMINATED MAHOGANY
1/2" (12mm) | <input type="checkbox"/> MOLDED PANEL |
| <input type="checkbox"/> STANDARD | |

ALUMINUM FRAMELESS OR FRAMED BYPASS & BIFOLD DOORS

ALUMINUM FRAMED & FRAMELESS FINISHES AVAILABLE

- | | |
|---|--|
| <input type="checkbox"/> SATIN BRASS (B1) | <input type="checkbox"/> BRIGHT BRASS (B2) |
| <input type="checkbox"/> WHITE (W1) | <input type="checkbox"/> SATIN CHROME (C1) |
| <input type="checkbox"/> BRIGHT CHROME (C2) | <input type="checkbox"/> ALUMINUM (A2) |

ES, SERIES or MODEL NUMBER:

FINISHED OPENING SIZE:

DOOR WIDTH:

DOOR HEIGHT:

FRONT FACING INSERT:

BACK FACING INSERT:

COMMENTS:

CUSTOM GLASS INSERT OPTIONS AVAILABLE

- | | |
|--|--|
| <input type="checkbox"/> CLEAR MIRROR | <input type="checkbox"/> SMOKED MIRROR |
| <input type="checkbox"/> BRONZE MIRROR | <input type="checkbox"/> CLEAR LAMINATED GLASS |
| <input type="checkbox"/> OPAQUE WHITE
LAMINATED GLASS | <input type="checkbox"/> BLACK BACK PAINTED
GLASS |
| <input type="checkbox"/> WHITE BACK PAINTED
GLASS | <input type="checkbox"/> STANDARD |
| <input type="checkbox"/> RED BACK PAINTED
GLASS | <input type="checkbox"/> SPECIAL ORDER GLASS:
_____ |

*Please see pages 6 and 7 for complete details of frame and glass / panel insert options

