



2012

Towing



# TOWING TABLE OF CONTENTS

## WHAT'S NEW

**4-5**

## RECEIVER HITCHES

**6-18**

Multi-Fit Receiver Hitches . . . . . 6-9	Front Mounted Hitch Receivers. . . . . 17	Goosenecks . . . . . 18
Custom-Fit Receiver Hitches . . . . . 10-16	Special Order Hitches. . . . . 18	Fifth Wheel Hitch . . . . . 18

## BALL MOUNTS & HITCH BALLS

**19-33**

Weather Resistant Finishes . . . . . 19	Interchangeable Hitch Ball Systems . . . . . 25	Dual Ball Mount . . . . . 28
InterLock® Ball Mounts . . . . . 20-21	Towing Security Kits - InterLock® . . . . . 26	Rotating Tri-Ball . . . . . 29
Ball Mounts . . . . . 22-23	Elite Towing Kits - InterLock® . . . . . 26	Triple Ball Mounts . . . . . 29
Receiver Adapters . . . . . 23	Towing Starter Kits. . . . . 27	Heavy Duty, Class V Towing . . . . . 30-33
InterLock® Hitch Balls. . . . . 24	Adjustable Ball Mount . . . . . 28	Pintles . . . . . 30
Standard Hitch Balls. . . . . 25	Forged Ball Mount . . . . . 28	2-1/2" Ball Mounts & Hitch Balls. . . . . 32

## LOCKS

**34-46**

Steering Wheel Locks. . . . . 34-35	Barrel Style Receiver Locks . . . . . 39-41	Spare Tire Carriers . . . . . 43
Reese Professional Locks. . . . . 36-37	Class V Receiver Locks & Pins . . . . . 41	Cable Locks . . . . . 44-45
Receiver Pins. . . . . 38	Coupler Locks . . . . . 42	SureLok™ Retractable Cable Security. . . . . 46
Draw Bar Locks. . . . . 39	Easy Access Locks . . . . . 43	
Bent Pin Lock . . . . . 39	Anti-Rattle Hitch Pin . . . . . 43	

## COUPLERS, JACKS & WINCHES

**47-59**

Key-Lok™ Couplers . . . . . 47	Class III & IV Bulk Couplers . . . . . 47	Top Wind Jacks. . . . . 58
Dual-Fit™ Couplers . . . . . 47	Single Speed Winches. . . . . 48-49	Side Wind Jacks . . . . . 58
Fas-Lok® Class I, II, III Couplers . . . . . 47	Two Speed Winches. . . . . 50-51	Farm Jack & Foot Plate . . . . . 59
Coupler Repair Kits. . . . . 47	Bull Dog Jacks and Couplers. . . . . 52-57	Powered Jack . . . . . 59

## TOWING ACCESSORIES

**60-68**

TransRACK Cargo Truck Rack . . . . . 60-61	Single Dose Hitch Ball Lubricant. . . . . 64	Tow Hook. . . . . 66
Dock Chock . . . . . 62	Wheel Bearing Protectors & Kits. . . . . 64	Receiver Tubes . . . . . 66
Wheel Chocks . . . . . 62	Towing Safety Cables. . . . . 64	Hitch Box Extensions . . . . . 66
Caster Wheels . . . . . 62	Step Bumper Receiver . . . . . 64	Clip-on Towing Mirrors . . . . . 67
Foot Plate . . . . . 62	Adjustable Tow Bar . . . . . 65	Blind Spot Mirrors . . . . . 67
Receiver Tube Covers. . . . . 63	Tow Bar Chains. . . . . 65	SoloHitch™ . . . . . 68
Hitch Ball Cover . . . . . 63	Cable Puller . . . . . 65	HindSight. . . . . 68
Hitch Ball Wrench . . . . . 63	Safety Chains . . . . . 66	Lighted Hitch Covers & Emblems. . . . . 68
Hitch Ball Bushings . . . . . 63	Quick Links . . . . . 66	

## APPLICATIONS GUIDE

**69-215**

## RESOURCES & MERCHANDISING

**216-221**

## INDEX

**222-224**

# TESTED

The #1 OEM Supplier to:   TOYOTA



Reese® Towpower Custom Built Trailer Hitches feature solid all-welded construction for maximum strength and safety! ✓

Computer aided design, fatigue and stress testing ensure a strong design that will withstand road abuse. ✓



To the Track and Back, with Towing Products Proven Quality & Innovation!

#1 IN S  
#1 IN D  
#1 IN T

# TOUGH!

 HONDA  HYUNDAI  KIA  MOPAR  SUBARU  MITSUBISHI



Custom built according to manufacturer vehicle weight specifications and model year to ensure a perfect fit and top towing performance! ✓

Each Reese® Towpower Hitch is American engineered and "Tested Tough" to deliver the absolute highest quality Trailer Hitch available anywhere! ✓



All Reese Towpower Hitches look great and work great with our full line of hitch accessories, including our exclusive InterLock® Hitch Balls & Ball Mount One Wrench Tightening System!



All Reese® Towpower Receiver Hitches meet and exceed V-5, CSA and SAE J684 standards and are inspected for quality and workmanship! ✓



SAFETY  
DESIGN  
TESTING



# WHAT'S



## **NEW! TransRACK CARGO TRUCK RACK**

- Fits any standard long and short truck bed
- No drill clamp installation and adjustability
- 800 lb capacity
- Wear resistant natural aluminum finish
- Stainless steel hardware
- Lightweight aluminum extrusion
- Easy-on cross bar clamps
- Double lock anchor points

**See pages 60-61**

# NEW!

## CHECK OUT THESE GREAT NEW INNOVATIONS



**NEW!**  
**2" TO 1-1/4"**  
**ADAPTER**

- Use 1-1/4" accessories with 2" hitches
- 3500/300 lb capacity
- Ideal for bike racks & cargo carriers

*See page 23*



**NEW!**  
**STEERING WHEEL LOCKS**

Three new state-of-the art Steering Wheel Locks represent the latest anti-theft technology

*See page 34-35*

**WHAT'S NEW**



**NEW!**  
**ADJUSTABLE COUPLER LOCK**

- 3/16" pin
- Adjusts from 5/8" to 3"

*See page 42*



**NEW!**  
**COUPLER PIN & CHAIN**

- 5/16" dia. pin, 1-1/8" long
- 7" chain

*See page 47*



**NEW!**  
**PINTLE PIN & CHAIN**

- 1/4" dia. pin, 1-3/4" long
- 5-1/2" chain

*See page 30*



**NEW!**  
**HEAVY DUTY PIN & CLIP**

- 3-1/2" span for 2-1/2" hitches
- Rugged clip hole

*See page 38*

# MULTI-FIT

## RECEIVER HITCHES

**RESE Receiver Hitch Class II**

- Built to last - 100% Hot Dip Galvanized Steel
- Heavy Duty Construction - 2" x 2" x 1/4" Tube
- Easy to Install - No Drilling
- 2" Receiver Opening
- 2" Safety Pin - 100% Hot Dip Galvanized Steel
- 2" Safety Pin - 100% Hot Dip Galvanized Steel
- 2" Safety Pin - 100% Hot Dip Galvanized Steel
- 2" Safety Pin - 100% Hot Dip Galvanized Steel
- 2" Safety Pin - 100% Hot Dip Galvanized Steel
- 2" Safety Pin - 100% Hot Dip Galvanized Steel

**RESE Receiver Hitch Class III**

- Built to last - 100% Hot Dip Galvanized Steel
- Heavy Duty Construction - 2" x 2" x 1/4" Tube
- Easy to Install - No Drilling
- 2" Receiver Opening
- 2" Safety Pin - 100% Hot Dip Galvanized Steel
- 2" Safety Pin - 100% Hot Dip Galvanized Steel
- 2" Safety Pin - 100% Hot Dip Galvanized Steel
- 2" Safety Pin - 100% Hot Dip Galvanized Steel
- 2" Safety Pin - 100% Hot Dip Galvanized Steel
- 2" Safety Pin - 100% Hot Dip Galvanized Steel

**RESE Receiver Hitch - Class III**

- Built to last - 100% Hot Dip Galvanized Steel
- Heavy Duty Construction - 2" x 2" x 1/4" Tube
- Easy to Install - No Drilling
- 2" Receiver Opening
- 2" Safety Pin - 100% Hot Dip Galvanized Steel
- 2" Safety Pin - 100% Hot Dip Galvanized Steel
- 2" Safety Pin - 100% Hot Dip Galvanized Steel
- 2" Safety Pin - 100% Hot Dip Galvanized Steel
- 2" Safety Pin - 100% Hot Dip Galvanized Steel
- 2" Safety Pin - 100% Hot Dip Galvanized Steel

5000 lb

Receiver Hitch - Class III

Use your hitch to tow or for other optional accessories.

Para los vehículos recreo, los furgonetas en caminos ligeros, para camionetas deportivas, camionetas camionetas livianas.



## **Class II Multi-Fit Receiver Hitches**

- 88001 - Fits many Chevy, Chrysler, Dodge, Ford Pick-ups, SUVs & Vans ..... 8  
 88002 - Fits many Buick, Chevy, Dodge, Ford, Lincoln, Mercury, Oldsmobile Cars & Vans ..... 8

## **Class III Multi-Fit Receiver Hitches**

- 37041 - Fits many Chevy, Ford, Mazda, Mercury, Oldsmobile SUVs & Vans ..... 8  
 37042 - Fits many Chevy, Chrysler, Dodge, Ford, Jeep, Mazda, Nissan SUV and Vans ..... 9  
 37096 - Fits many Chevy, Dodge, Ford, GMC Pick-ups ..... 9

## **Class IV Multi-Fit Receiver Hitch**

- 37094 - Fits many Chevy, Dodge, Ford, GMC, Toyota Pick-ups ..... 9

- **Quick and Easy Installation**
- **Many NO DRILL Applications**
- **No Special Tools Required for Installation**
- **METAL SHIELD Protective Coating**  
 For Increased Corrosion Resistance  
 OEM Quality Protection



**TESTED TOUGH**

TM

- **Solid Construction for Maximum Strength and Safety**
- **All Hitches Meet or Exceed V5, VS, CSA and SAE J684 Standards**
- **Inspected for Superior Quality and Craftsmanship**
- **Backed by a 3 Year Limited Warranty**
- **OEM Quality Black Powder Coat over E-Coat Finish for TWO Layers of Superior Protection**



# MULTI-FIT

Custom Applications Available by Special Order! See pages 10-16.



## **88001 CLASS II MULTI-FIT RECEIVER HITCH**

- 1-1/4" SQUARE RECEIVER TUBE OPENING
- Passenger Car, SUV, Van & Light Truck Applications
- Hitch Box Cover Included

Description	Maximum Rated Capacity	
	Gross Trailer Wt.	Tongue Wt.
Weight Carrying	up to 3500 lb	up to 350 lb



## **88002 CLASS II MULTI-FIT RECEIVER HITCH**

- 1-1/4" SQUARE RECEIVER TUBE OPENING
- Passenger Car, SUV, Van & Light Truck Applications
- Hitch Box Cover Included

Description	Maximum Rated Capacity	
	Gross Trailer Wt.	Tongue Wt.
Weight Carrying	up to 3500 lb	up to 350 lb



## **37041 CLASS III MULTI-FIT RECEIVER HITCH**

- 2" SQUARE RECEIVER TUBE OPENING
- Passenger Car, SUV, Van & Light Truck Applications
- Includes OEM Style Unbreakable Receiver Plug

Description	Maximum Rated Capacity	
	Gross Trailer Wt.	Tongue Wt.
Weight Carrying	up to 5000 lb	up to 500 lb

MULTI-FIT HITCHES



**CLASS II**  
**CLASS III**

## **MULTI-FIT HITCHES**

- Quick and easy installation
- Many applications are **NO DRILL** for fast and easy installation
- No special tools required for installation



# MULTI-FIT

## **37042 CLASS III MULTI-FIT RECEIVER HITCH**

- 2" SQUARE RECEIVER TUBE OPENING
- Passenger Car, SUV, Van & Light Truck Applications
- Hitch Box Cover Included

Description	Maximum Rated Capacity	
	Gross Trailer Wt.	Tongue Wt.
Weight Carrying	up to 5000 lb	up to 500 lb



## **37096 CLASS III MULTI-FIT RECEIVER HITCH**

- 2" SQUARE RECEIVER TUBE OPENING
- Passenger Car, SUV, Van & Light Truck Applications
- Hitch Box Cover Included

Description	Maximum Rated Capacity	
	Gross Trailer Wt.	Tongue Wt.
Weight Carrying	up to 5000 lb	up to 500 lb



## **37094 CLASS IV MULTI-FIT RECEIVER HITCH**

- 2" SQUARE RECEIVER TUBE OPENING
- Passenger Car, SUV, Van & Light Truck Applications
- Includes OEM Style Unbreakable Receiver Plug

Description	Maximum Rated Capacity	
	Gross Trailer Wt.	Tongue Wt.
Weight Carrying	up to 7000 lb	up to 700 lb
with Weight Dist.	up to 12000 lb	up to 1200 lb



All Reese Towpower Hitches Meet or Exceed V-5/ SAE J-684 Standards



**CLASS III**  
**CLASS IV**

MULTI-FIT HITCHES

# CUSTOM-FIT

## RECEIVER HITCHES



- **Designed For a Perfect Fit and a Great Look**
- **Many NO DRILL Applications**
- **METAL SHIELD Protective Coating**  
For Increased Corrosion Resistance  
OEM Quality Protection



Reese Towpower Hitches are custom built according to exact manufacturer and model year specifications to ensure a perfect fit and superior towing performance.

**Class I**  
**Custom-Fit Hitches**  
 Insta-Hitch I - 77 Series\* .....12  
 Insta-Hitch I - 51 Series.....12

**Class II**  
**Custom-Fit Hitches**  
 Insta-Hitch II - 06 Series\* .....13  
 Insta-Hitch II - 51 Series.....13

**Class III**  
**Custom-Fit Hitches**  
 Premium III - 33 Series\* .....14  
 Premium III - 35 Series\* .....14  
 Premium III - 36 Series\* .....14

**Class IV**  
**Custom-Fit Hitches**  
 Professional IV - 37 Series\* .....15  
 Professional IV - 44 Series\* .....15  
 Professional IV - 51 Series .....15

**Class V**  
**Custom-Fit Hitches**  
 Professional IV - 41 Series\* .....16  
 Professional IV - 45 Series\* .....16



- Solid All-Welded Construction for Maximum Strength and Safety
- All Hitches Meet or Exceed V5, VS, CSA and SAE J684 Standards
- Inspected for Superior Quality and Craftsmanship
- Backed by a Limited Lifetime Warranty
- OEM Quality Black Powder Coat over E-Coat Finish for TWO Layers of Superior Protection

# CUSTOM-FIT



## **77 SERIES CLASS I CUSTOM-FIT INSTA-HITCH**

- 1-1/4" SQUARE RECEIVER TUBE OPENING
- Economical Class I receiver tube hitch
- Comes complete with ball mount, pin and clip
- Attaches to vehicle frame and/or bumper
- Resists rust and corrosion

Description	Maximum Rated Capacity	
	Gross Trailer Wt.	Tongue Wt.
Weight Carrying	up to 2000 lb	up to 200 lb



## **51 SERIES CLASS I CUSTOM-FIT INSTA-HITCH**

- 1-1/4" SQUARE RECEIVER TUBE OPENING
- Economical Class I receiver tube hitch
- Comes complete with ball mount, pin and clip
- Attaches to vehicle frame and/or bumper
- Resists rust and corrosion

Description	Maximum Rated Capacity	
	Gross Trailer Wt.	Tongue Wt.
Weight Carrying	up to 2000 lb	up to 200 lb



# CLASS I



# CUSTOM-FIT

## 06 SERIES CLASS II CUSTOM-FIT INSTA-HITCH

- 1-1/4" SQUARE RECEIVER TUBE OPENING
- Economical Class II receiver tube hitch
- Comes complete with ball mount, pin and clip
- Attaches to vehicle frame and/or bumper
- Resists rust and corrosion

Description	Maximum Rated Capacity	
	Gross Trailer Wt.	Tongue Wt.
Weight Carrying	up to 3500 lb	up to 350 lb



## 51 SERIES CLASS II CUSTOM-FIT INSTA-HITCH

- 1-1/4" SQUARE RECEIVER TUBE OPENING
- Economical Class II receiver tube hitch
- Comes complete with ball mount, pin and clip
- Attaches to vehicle frame and/or bumper
- Resists rust and corrosion

Description	Maximum Rated Capacity	
	Gross Trailer Wt.	Tongue Wt.
Weight Carrying	up to 3500 lb	up to 350 lb



# CLASS II

# CUSTOM-FIT



## **33 SERIES CLASS III CUSTOM-FIT HITCH**

- 2" SQUARE RECEIVER TUBE OPENING
- Round tubes available on some models
- Ball mount, pin and clip sold separately
- Attaches to vehicle frame and/or bumper
- Includes distinctive collar and plug

Description	Maximum Rated Capacity	
	Gross Trailer Wt.	Tongue Wt.
Weight Carrying	up to 8000 lb	up to 800 lb
Weight Distribution	up to 12000 lb	up to 1200 lb



## **35 SERIES CLASS III CUSTOM-FIT HITCH**

- 2" SQUARE RECEIVER TUBE OPENING
- Round tubes available on some models
- Ball mount, pin and clip sold separately
- Attaches to vehicle frame and/or bumper
- Includes distinctive collar and plug

Description	Maximum Rated Capacity	
	Gross Trailer Wt.	Tongue Wt.
Weight Carrying	up to 5000 lb	up to 500 lb



## **36 SERIES CLASS III CUSTOM-FIT HITCH**

- 2" SQUARE RECEIVER TUBE OPENING
- Round tubes available on some models
- Ball mount, pin and clip sold separately
- Attaches to vehicle frame and/or bumper
- Includes distinctive collar and plug

Description	Maximum Rated Capacity	
	Gross Trailer Wt.	Tongue Wt.
Weight Carrying	up to 5000 lb	up to 500 lb



# CLASS III



# CUSTOM-FIT

## 37 SERIES CLASS IV CUSTOM-FIT HITCH

- 2" SQUARE RECEIVER TUBE OPENING
- Round tubes available on some models
- Ball mount, pin and clip sold separately
- Attaches to vehicle frame and/or bumper
- Includes distinctive collar and plug

Description	Maximum Rated Capacity	
	Gross Trailer Wt.	Tongue Wt.
Weight Carrying	up to 7500 lb	up to 750 lb
Weight Distribution	up to 12000 lb	up to 1200 lb



## 44 SERIES CLASS IV CUSTOM-FIT HITCH

- 2" SQUARE RECEIVER TUBE OPENING
- Round tubes available on some models
- Ball mount, pin and clip sold separately
- Attaches to vehicle frame and/or bumper
- Includes distinctive collar and plug

Description	Maximum Rated Capacity	
	Gross Trailer Wt.	Tongue Wt.
Weight Carrying	up to 8000 lb	up to 800 lb
Weight Distribution	up to 12000 lb	up to 1200 lb



## 51 SERIES CLASS III-IV CUSTOM-FIT HITCH

- 2" SQUARE RECEIVER TUBE OPENING
- Round tubes available on some models
- Ball mount, pin and clip sold separately
- Attaches to vehicle frame and/or bumper
- Includes distinctive collar and plug

Description	Maximum Rated Capacity	
	Gross Trailer Wt.	Tongue Wt.
Weight Carrying	up to 6000 lb	up to 600 lb
Weight Distribution	up to 10500 lb	up to 1050 lb



CUSTOM-FIT HITCHES



# CLASS IV



# CUSTOM-FIT

## 41 SERIES CLASS V CUSTOM-FIT HITCH



- 2" SQUARE RECEIVER TUBE OPENING
- Designed for full-sized long wheelbase trucks, vans and utility vehicles with full frames and heavy-duty suspensions
- Ideal for High tongue weight applications
- Strong, secure heavy-duty side bracket design
- All frame attachments, J-Pin® ready
- Black powder coat finish over e-coat

Description	Maximum Rated Capacity	
	Gross Trailer Wt.	Tongue Wt.
Weight Carrying	up to 15000 lb	up to 1500 lb
Weight Distribution	up to 16000 lb	up to 1600 lb

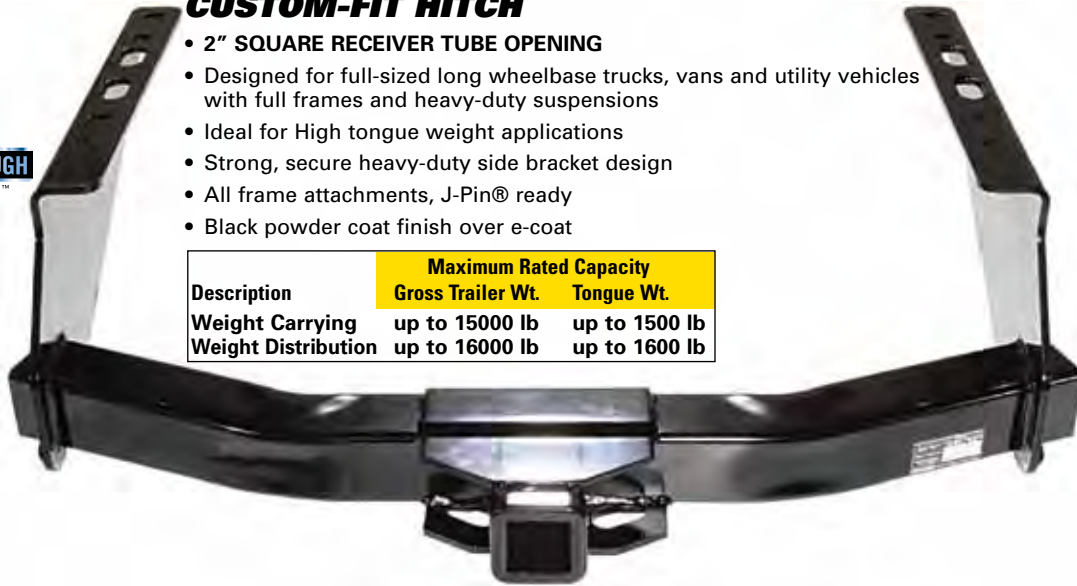

## 45 SERIES CLASS V CUSTOM-FIT HITCH



- 2-1/2" SQUARE RECEIVER TUBE OPENING
- Designed for full-sized long wheelbase trucks, vans and utility vehicles with full frames and heavy-duty suspensions
- Ideal for High tongue weight applications (Toy Hauler & Commercial)
- Strong, secure heavy-duty side bracket design
- All frame attachments, J-Pin® ready
- Pin, clip, receiver tube cover and welded electrical bracket included

Description	Maximum Rated Capacity	
	Gross Trailer Wt.	Tongue Wt.
Weight Carrying	up to 18000 lb	up to 2000 lb
Weight Distribution	up to 18000 lb	up to 2500 lb

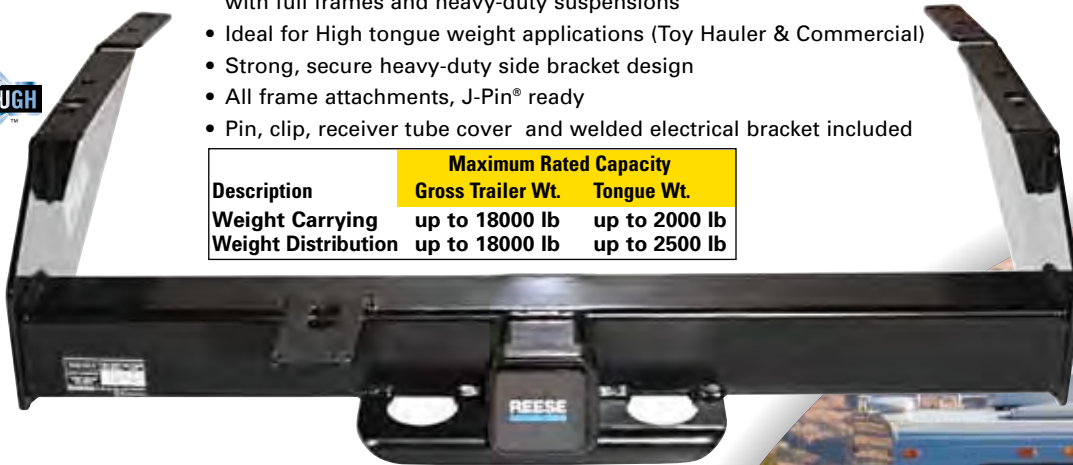

# CLASS V



# FRONT MOUNT

## FRONT MOUNT RECEIVERS

- 2" SQUARE RECEIVER TUBE OPENING
- Up to 9000 lb line pull / 500 lb TW
- Front mounted receivers offer a secure and useful attachment point
- All frame attachments, J-Pin® ready

See Application Guide Pages 214-215 to select your Front Mount Receiver



## FRONT MOUNTED RECEIVER ACCESSORIES

Part Number	Description
<b>6495</b>	Winch Mounting Plate - provides an easily removable platform for mounting your winch
<b>6980</b>	Handle Kit for 6495 Winch Mounting Plate
<b>6715</b>	Spare Tire Carrier - provides up front carriage of your spare, universal bolt pattern
<b>6758</b>	Work Step - provides easy access to engine, can be used on rear Class III/IV receivers
<b>6771</b>	Receiver Tube Skid Shield - recommended for use with receivers mounted below the bumper
<b>5443</b>	License Plate Adapter - solve the problem of the front hitch interfering with the plate
<b>49802</b>	Fold Down License Plate Holder



**6495**  
Winch Mount in use  
Winches not available through Reese Towpower



**6715**  
Spare Tire Carrier



**6980**  
Handle Kit for 6495



**6495**  
Work Step



**6771**  
Receiver Tube Skid Shield



**5443**  
License Plate Adapter

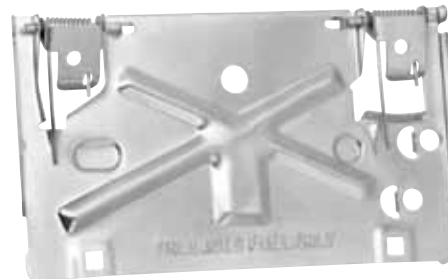

**49802**  
Fold Down License Plate Holder

# SPECIAL ORDER

*Special*  
**ORDER**

## SPECIAL ORDER PROGRAM

Can't find the Reese Towpower product that you're looking for on the shelf? There is a complete line of towing products and vehicle accessories available by special order.

Special order items include:

- Custom Fit Hitches for Class I, II, & III Towing Applications
- Class IV/V Hitches for heavy duty towing
- Weight Distributing Systems
- Front Mount Receivers
- Fifth Wheel Towing Solutions
- Electrical Products
- Bike Carriers, Cargo Management Products & Accessories
- Ramps and Jacks

Special Ordering products is quick and easy. Simply find the name and part number of the Reese Towpower product that you would like and ask your in-store customer service specialist for assistance. They will give you an approximate shipping time and cost for your desired item.

Items are shipped ground via common carrier and typically takes 3-5 business days to arrive.

Your in-store customer service specialist will contact you to pick up the product when it arrives.

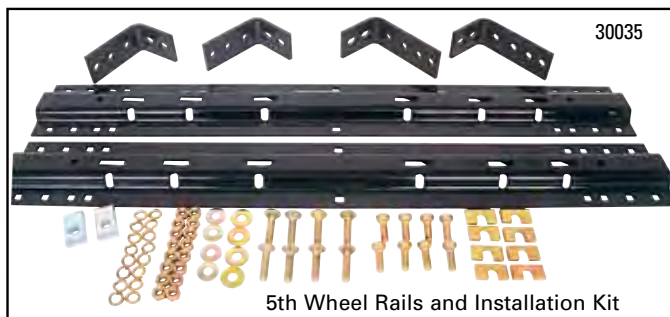

## GOOSENECKS HITCHES

- Above bed, below bed or fold down hitches available
- 25000 to 30000 lb rating
- Easy installation and removal
- Rail kits available for most applications

## FIFTH WHEEL HITCHES

- 4-way pivoting head
- Full 5 degrees of side-to-side pivot for easy hook-ups on uneven ground
- Rounded slide bar jaw mechanism; designed for automatic self-latching
- One-piece formed legs; provides a wider footprint for superior stability
- Universal mounting kit included (#30035)
- 15000 lb capacity; 3750 lb pin weight capacity
- Available by Special Order

30056





## BALL MOUNTS & HITCH BALLS

- Reese Towpower - The Leader in Innovative and Quality Towing Products.
- From bulk packaging to state-of-the-art merchandising displays, Reese Towpower® has the options you and your customers are looking for.

## WEATHER RESISTANT FINISHES



- A specialized OEM coating process for a superior look and finish.
- Products are dipped in a zinc-phosphate based, rust resistant coating to provide unmatched coverage in "hard to fill" areas.
- A secondary powdercoat layer is applied for TWO layers of superior protection.

## CHROME

- Chrome plated steel with high gloss finish
- Naturally rust resistant

## Black Nickel

- Superior corrosion protection
- Enhanced appearance with Reese Towpower's Black Nickel finish



- Many competitive Hitches and Ball Mounts have only a single layer of paint. This type of product protection is inadequate against rust & corrosion.

# INTERLOCK BALL MOUNTS



**One Wrench Tightening System!**

21901

21900

## CLASS II - INTERLOCK BALL MOUNTS

Part Number	Box Opening Dimensions	Hitch Ball Hole Size	Length	Drop	Rise	Capacity
<b>21901</b>	1-1/4" x 1-1/4"	3/4"	9"	1-1/4"	3/4"	3500/300 lb
<b>21900</b>	1-1/4" x 1-1/4"	3/4"	7"	2-1/2"	2"	3500/300 lb



### COLOR CODING GUIDE

Fits 1-1/4" Hitch Boxes

Fits 2" Hitch Boxes



**One Wrench Tightening System!**

21792

21793

21794

## CLASS III - INTERLOCK BALL MOUNTS

Part Number	Box Opening Dimensions	Hitch Ball Hole Size	Length	Drop	Rise	Capacity
<b>21792</b>	2" x 2"	1"	9"	2"	3/4"	6000/600 lb
<b>21793</b>	2" x 2"	1"	9-1/2"	3-1/4"	2"	5000/500 lb
<b>21794</b>	2" x 2"	1"	10"	5-1/4"	4"	5000/500 lb

# INTERLOCK BALL MOUNTS



One Wrench Tightening System!



## CLASS III - STAINLESS STEEL INTERLOCK BALL MOUNTS

Part Number	Box Opening Dimensions	Hitch Ball Hole Size	Length	Drop	Rise	Capacity
<b>21790</b>	2" x 2"	1"	9-1/2"	2"	3/4"	6000/600 lb
<b>21791</b>	2" x 2"	1"	9-1/2"	3-1/4"	2"	5000/500 lb



One Wrench Tightening System!

# CHROME

## CLASS III - CHROME INTERLOCK BALL MOUNTS

Part Number	Box Opening Dimensions	Hitch Ball Hole Size	Length	Drop	Rise	Capacity
<b>7034300</b>	2" x 2"	1"	9"	2"	3/4"	6000/600 lb
<b>7034400</b>	2" x 2"	1"	9-1/2"	3-1/4"	2"	5000/500 lb

## BALL MOUNTS

### CLASS II - ZINC BALL MOUNTS

Part Number	Box Opening Dimensions	Hitch Ball Hole Size	Length	Drop	Rise	Capacity
<b>06280</b>	1-1/4" x 1-1/4"	3/4"	9"	1-1/4"	3/4"	3500/300 lb
<b>06474</b>	1-1/4" x 1-1/4"	3/4"	7"	2-1/2"	2"	3500/300 lb



06280

06474

## CHROME



21287

21288

21289

### CLASS III / IV - CHROME BALL MOUNTS

Part Number	Box Opening Dimensions	Hitch Ball Hole Size	Length	Drop	Rise	Capacity
<b>21287</b>	2" x 2"	1"	8"	2"	3/4"	6000/600 lb
<b>21288</b>	2" x 2"	1"	8-1/2"	3-1/4"	2"	5000/500 lb
<b>21289</b>	2" x 2"	1"	11-1/2"	5-1/4"	4"	5000/500 lb

# BALL MOUNTS



21186 - 5-1/4" drop  
Not Shown:  
21344 - 4" drop  
21345 - 4" drop



RESISTS RUST & CORROSION

**COLOR CODING GUIDE**

Fits 1-1/4" Hitch Boxes

Fits 2" Hitch Boxes

**CLASS III / IV - STANDARD BALL MOUNTS**

Part Number	Box Opening Dimensions	Hitch Ball Hole Size	Length	Drop	Rise	Capacity
<b>21171</b>	2"x 2"	1"	8"	2"	3/4"	6000/600 lb
<b>21175</b>	2"x 2"	1"	8-1/2"	3-1/4"	2"	5000/500 lb
<b>21186</b>	2"x 2"	1"	10"	5-1/4"	4"	5000/500 lb
<b>21344</b>	2"x 2"	1"	9"	4"	2-3/4"	6000/600 lb
<b>21345</b>	2"x 2"	1"	11"	4"	2-3/4"	5000/500 lb
<b>21347</b>	2"x 2"	1"	10"	8"	6-3/4"	5000/500 lb



**NEW!**

**1-1/4" TO 2" RECEIVER ADAPTERS**

- 7020500** Receiver Adapter - 1-1/4" to 2", 6" length
- 7022900** Receiver Adapter - 1-1/4" to 2", 10" length

- Enables 1-1/4" receiver to fit popular 2" accessories such as bike and cargo carriers

**2" TO 1-1/4" RECEIVER ADAPTER**

- 7052500** Receiver Adapter - 2" to 1-1/4", 7" length

- Use 1-1/4" accessories with 2" hitches
- 300/3500 lb capacity
- Ideal for bike racks & cargo carriers



## INTERLOCK HITCH BALLS

- Reese Towpower® - the leader in developing high impact product displays with minimal packaging.
- We offer a complete Hitch Ball and Display Rack System, enabling customers to quickly select the right Hitch Ball.
- Self-facing racks provide "Finished" appearance.
- Reese Towpower® solid steel hitch balls are engineered to meet all safety requirements of SAE J-684.



# InterLock®

**One Wrench Tightening System!**

7008800 Hitch Ball Rack  
See page 220

### CHROME INTERLOCK HITCH BALLS

Peggable Part No.	Open Style Part No.	Ball Diameter	Shank Diameter	Shank Length	Lift	Capacity
<b>72801</b>	<b>7008100</b>	1-7/8"	3/4"	1-1/2"	Standard	2000 lb
<b>72804</b>	<b>7008400</b>	1-7/8"	3/4"	2-3/8"	Standard	2000 lb
<b>72807</b>	<b>7008700</b>	1-7/8"	1"	2"	Standard	2000 lb
<b>72802</b>	<b>7008200</b>	2"	3/4"	1-1/2"	Standard	3500 lb
<b>72803</b>	<b>7008300</b>	2"	1"	2"	Standard	6000 lb
<b>72805</b>	<b>7008500</b>	2"	3/4"	2-3/8"	Standard	3500 lb
<b>72806</b>	<b>7008600</b>	2-5/16"	1"	2"	Standard	6000 lb

### STAINLESS STEEL INTERLOCK HITCH BALLS

Peggable Part No.	Open Style Part No.	Ball Diameter	Shank Diameter	Shank Length	Lift	Capacity
<b>72843</b>	<b>7011300</b>	2"	1"	2"	Standard	6000 lb
<b>72844</b>	<b>7011400</b>	2-5/16"	1"	2"	Standard	6000 lb

### REPLACEMENT NUTS AND WASHERS

<b>7027800</b>	3/4" Nut and washer for hitch ball
<b>7027900</b>	1" Nut and washer for hitch ball
<b>7028000</b>	1-1/4" Nut and washer for hitch ball

When Installing Reese Towpower Hitch Balls, torque all 3/4" shank balls to 160 ft. lb, all 1" to 250 ft. lb and 1-1/4" shank balls to 450 ft. lb



# STANDARD HITCH BALLS



### COLOR CODING GUIDE

**Fits 3/4" Shank Holes**

**Fits 1" Shank Holes**

**Fits 1-1/4" Shank Holes**

## CHROME HITCH BALLS - PACKAGED

- Dual wrench flats

Part Number	Ball Diameter	Shank Diameter	Shank Length	Lift	Capacity
<b>74006</b>	1-7/8"	3/4"	1-1/2"	Standard	2000 lb
<b>74013*</b>	1-7/8"	3/4"	2-3/8"	Standard	2000 lb
<b>74022</b>	1-7/8"	1"	2"	Standard	2000 lb
<b>74023*</b>	1-7/8"	3/4"	3-3/8"	Standard	2000 lb
<b>74024*</b>	1-7/8"	1"	3-1/4"	Standard	2000 lb
<b>74008</b>	2"	3/4"	1-1/2"	Standard	3500 lb
<b>74010</b>	2"	1"	2"	Standard	6000 lb
<b>74020*</b>	2"	3/4"	2-3/8"	Standard	3500 lb
<b>74025*</b>	2"	3/4"	3-3/8"	Standard	3500 lb
<b>74026*</b>	2"	1"	3-1/4"	Standard	6000 lb
<b>74021</b>	2-5/16"	1"	2"	Standard	6000 lb
<b>74294</b>	2-5/16"	1-1/4"	2-1/2"	Standard	12000 lb

\* Long Shank - designed for use with step bumpers

## ZINC HITCH BALLS - PACKAGED

Part Number	Ball Diameter	Shank Diameter	Shank Length	Lift	Capacity
<b>74005</b>	1-7/8"	3/4"	1-1/2"	Standard	2000 lb
<b>74007</b>	2"	3/4"	1-1/2"	Standard	3500 lb
<b>74009</b>	2"	1"	2"	Standard	6000 lb
<b>74011</b>	2-5/16"	1"	2"	Standard	6000 lb

- When Installing Reese Towpower Hitch Balls, torque all 3/4" shank balls to 160 ft. lb, all 1" to 250 ft. lb and 1-1/4" shank balls to 450 ft. lb
- REESE TOWPOWER® solid steel hitch balls are engineered to meet all safety requirements of SAE J-684.

## INTERCHANGEABLE CHROME HITCH BALL SYSTEMS

Part Number	Shank Diameter	Ratings GTW/TW	Hitch Ball Diameters
<b>74307</b>	3/4"	5000/500 lb	1-7/8", 2"
<b>74308</b>	1"	8000/1000 lb	1-7/8", 2"
<b>74309</b>	1"	8000/1000 lb	1-7/8", 2", 2-5/16"

## 1-7/8" ATV/LAWN TRACTOR CHROME HITCH BALL

Part Number	Ball Diameter	Shank Diameter	Shank Length	Capacity
<b>7036800</b>	1-7/8"	5/8"	1-3/4"	2000 lb



## HITCH BALL LUBRICANT

**7029600** Single dose hitch ball lubricant - 2 Pack

- Water resistant
- Reduces coupler and ball wear
- Fights corrosion
- Eases coupling



## TOWING SECURITY KITS - INTERLOCK

### CLASS III - TOWING SECURITY KITS - INTERLOCK

Part Number	Box Opening Dimensions	Length	Drop	Rise	Ball Size	Lock	Capacity
<b>21554</b>	2" x 2"	9"	2"	3/4"	2"	5/8"	6000/600 lb
<b>7005100</b>	2" x 2"	9"	2"	3/4"	2"	5/8"	6000/600 lb
<b>7005200</b>	2" x 2"	9-1/2"	3-1/4"	2"	2"	5/8"	5000/500 lb



21554 - Includes Bag and Hitch Cover

## BALL & BALL MOUNT COMBINATION

### CLASS III - INTERLOCK

Part Number	Box Opening Dimensions	Length	Drop	Rise	Ball Size	Capacity
<b>7039200</b>	2" x 2"	9"	2"	3/4"	2"	6000/600 lb
<b>7039300</b>	2" x 2"	9-1/2"	3-1/4"	2"	2"	5000/500 lb

7039200



## Black Nickel Coating

Now get enhanced corrosion protection and appearance with Reese Towpower's Black Nickel finish. Includes hitch ball and ball mount. When purchased with the Elite Security lock, you're ready to tow.

# TOWING STARTER KITS

## CLASS II STARTER KITS - INTERLOCK

Part Number	Box Opening	Length	Drop	Rise	Ball Size	Pin & Clip	Capacity
<b>7043000</b>	1-1/4"	9	1-1/4"	3/4"	2"	1/2"	3500 lb
<b>7043100</b>	1-1/4"	7	2-1/2"	2"	2"	1/2"	3500 lb

## CLASS III STARTER KITS - INTERLOCK

Part Number	Box Opening	Length	Drop	Rise	Ball Size	Pin & Clip	Capacity
<b>21542</b>	2" x 2"	9"	2"	3/4"	2"	5/8"	6000/600 lb
<b>21543</b>	2" x 2"	9-1/2"	3-1/4"	2"	2"	5/8"	5000/500 lb

## CLASS III STARTER KITS - STANDARD

Part Number	Box Opening	Length	Drop	Rise	Ball Size	Pin & Clip	Capacity
<b>21536</b>	2" x 2"	8"	2"	3/4"	2"	5/8"	6000/600 lb
<b>21556</b>	2" x 2"	9-1/2"	3-1/4"	2"	2"	5/8"	5000/500 lb
<b>7043200</b>	2" x 2"	8"	2"	3/4"	1-7/8"	5/8"	6000/600 lb



7043100

**InterLock**  
One Wrench Tightening System!



Pin & Clip is Attached to Ball Mount

**InterLock**  
One Wrench Tightening System!



Pin & Clip is Shrink Wrapped to Ball Mount

21542



21536



Pin & Clip is Shrink Wrapped to Ball Mount

**COLOR CODING GUIDE**

- Fits 1-1/4" Hitch Boxes
- Fits 2" Hitch Boxes
- Fits 2-1/2" Hitch Boxes

BALL MOUNTS & HITCH BALLS

# BALL MOUNTS



21141  
7031300

21332

1-1/4"  
Shank Hole

21511



RESISTS RUST & CORROSION

## CLASS III - WEIGHT CARRYING BALL MOUNT - ADJUSTABLE

Part Number	Box Opening Dimensions	Hitch Ball Hole Size	Length	Drop Range	Rise Range	Capacity*	
<b>21141</b>	Closed Box	2" x 2"	1"	13-1/2"	3" to 7-1/2"	1-3/4" to 6-1/4"	5000/500 lb
<b>7031300</b>	Open Style	2" x 2"	1"	13-1/2"	3" to 7-1/2"	1-3/4" to 6-1/4"	5000/500 lb

\*350/3500 when used in rise position

## CLASS III / V - FORGED - 16000 LB BALL MOUNT

Part Number	Box Opening Dimensions	Hitch Ball Hole Size	Length	Drop	Rise	Capacity
<b>21330</b>	2" x 2"	1-1/4"	8-1/2"	2"	1"	16000/1600 lb
<b>21331</b>	2" x 2"	1-1/4"	9-1/4"	4"	3"	16000/1600 lb
<b>21332</b>	2" x 2"	1-1/4"	10-1/4"	6"	5"	16000/1600 lb

## DUAL BALL MOUNT - ALL BLACK

Part Number	Box Opening Dimensions	Hitch Ball	Length	Drop	Rise	Capacity
<b>21511</b>	2" x 2"	1-7/8"	10"	2"	--	2000/200 lb
		2"	10"	--	3/4"	6000/600 lb
<b>21518</b>	2" x 2"	2"	10"	2"	--	6000/600 lb
		2-5/16"	10"	--	3/4"	6000/600 lb

### COLOR CODING GUIDE

Fits 1-1/4"  
Hitch Boxes

Fits 2"  
Hitch Boxes

Fits 2-1/2"  
Hitch Boxes

# MULTIPLE BALL MOUNTS



7039800  
**Black Nickel**

*Black Nickel*



**CHROME**

21514  
**Chrome**



21512  
7022400  
**Black**

## TRIPLE BALL MOUNTS BLACK NICKEL, CHROME AND BLACK

Part Numbers	Box Opening Dimensions	Hitch Balls	Length	Capacity
<b>7039800</b>	2" x 2"	1-7/8", 2", 2-5/16"	8"	2000/200 lb
<b>21514</b>	2" x 2"	1-7/8", 2", 2-5/16"	8"	6000/600 lb
<b>21512</b>	2" x 2"	1-7/8", 2", 2-5/16"	8"	10000/1000 lb
<b>7022400</b>	2" x 2"	1-7/8", 2", 2-5/16"	8"	10000/1000 lb

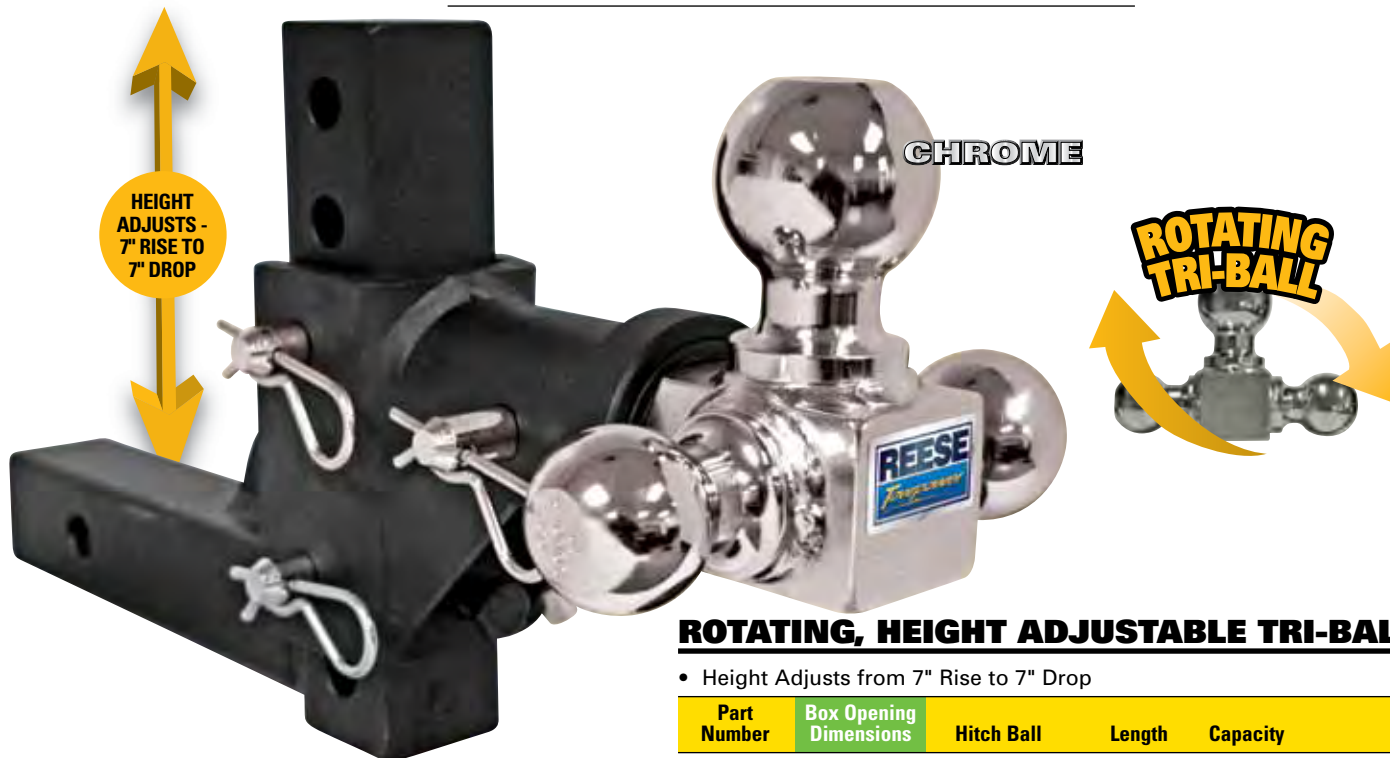

HEIGHT  
ADJUSTS -  
7" RISE TO  
7" DROP

**CHROME**

**ROTATING  
TRI-BALL**

## ROTATING, HEIGHT ADJUSTABLE TRI-BALL

- Height Adjusts from 7" Rise to 7" Drop

Part Number	Box Opening Dimensions	Hitch Ball	Length	Capacity
<b>7021800</b>	2" x 2"	1-7/8"	10"	6000/600 lb
		2"	10"	10000/1000 lb
		2-5/16"	10"	10000/1000 lb

## PINTLE HOOKS & LUNETTES



### 8 TON PINTLE BALL & HOOK COMBINATIONS

Part No.	Ball Size	Shank	Hook GTW	Max. TW	Ball Rating
<b>74115</b>	1-7/8"	1-1/4"	16000 lb	3000 lb	6000 lb
<b>74116</b>	2"	1-1/4"	16000 lb	3000 lb	10000 lb
<b>74117</b>	2-5/16"	1-1/4"	16000 lb	3000 lb	14000 lb

- Mounting hardware included

### PINTLE REPLACEMENT BALLS

Part No.	Description	Shank	Length	Capacity
<b>7021500</b>	1-7/8" Replacement Ball	1-1/4"	2-1/4"	6000 lb
<b>7021600</b>	2" Replacement Ball	1-1/4"	2-1/4"	10000 lb
<b>7021700</b>	2-5/16" Replacement Ball	1-1/4"	2-1/4"	14000 lb

### PINTLE HOOK / REGULAR

Part No.	Description	Max. GTW	Max. TW
<b>74118</b>	10-ton pintle hook	20000 lb	4000 lb
<b>74119</b>	15-ton pintle hook	30000 lb	6000 lb

- Mounting hardware included

**NEW!**



### PINTLE PIN AND CHAIN

Part No.	Description
<b>7044900</b>	Pintle pin and chain, 1/4" diameter pin, 7" long, 7" chain

### LUNETTE EYE

Part No.	Description	Max. GTW	Vert. Load
<b>7013700</b>	Lunette Ring, 2-1/2" dia., 4" Hole	42000 lb Capacity	4000 lb

- Mounting hardware sold separately



7013700



### PINTLE HOOK MOUNTING PLATE

Part No.	Description	Shank Length	Plate Size
<b>74281</b>	Pintle hook mounting plate for 2" square (10000 lb)	7-3/4"	7-1/2" x 5"

## HEAVY DUTY TOWING

Our Heavy Duty products are designed with strength, durability and ease of use in mind.

Most simply slide into a receiver tube and secure with a pin and clip. Others bolt on, but are easily adjustable. Perfect for hauling heavy loads.

# PINTLE HOOKS, EYES AND RINGS

## 2" RECEIVER MOUNT PINTLE/BALL COMBO

Part No.	Description	Max. GTW	Ball GTW	Max. VL
<b>7024000</b>	1-7/8" ball and pintle combo	12000 lb	2000 lb	2400 lb
<b>7024100</b>	2" ball and pintle combo	12000 lb	7000 lb	2400 lb
<b>7024200</b>	2-5/16" ball & pintle combo	12000 lb	12000 lb	2400 lb



7024000

## 5 TON 2" RECEIVER MOUNT PINTLE HOOK

Part No.	Description	Max. GTW	Max. VL
<b>7024300</b>	5 ton pintle hook	10000 lb	2000 lb

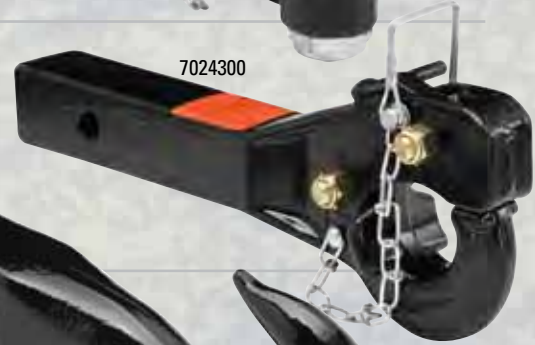

7024300

## 2" RECEIVER MOUNT TOW HOOK

Part No.	Description	GTW	Length
<b>7024400</b>	Forged receiver mount tow hook	10000 lb	7-3/4"



7024400

## 2" RECEIVER MOUNT TOW EYE

Part No.	Description	GTW	Length
<b>7024500</b>	Forged receiver mount tow eye	10000 lb	7-3/8"



7024500

## 2" RECEIVER MOUNT TOW RING

Part No.	Description	GTW	Length
<b>7024600</b>	Receiver mount tow ring	8000 lb	7-3/8"



7024600



54970

## WEIGHT DISTRIBUTING SYSTEMS

### HEAVY DUTY ROUND BAR

- Features easy-to-use adjusting blocks for easier and faster ball mount angle adjustment
- Includes a one-piece cast head, spring bars with integrated cam, snap-up brackets and chains

Part No.	Description	Max. GTW	Max. Hitch Wt.
<b>49901</b>	Weight distributing system	10000 lb	550 lb
<b>49902</b>	Weight distributing system	10000 lb	750 lb
<b>49903</b>	Weight distributing system	10000 lb	1000 lb
<b>54970</b>	Adjustable hitch bar	10000 lb	1000 lb

Adjustable Hitch Bar Sold Separately



# CLASS V BALL MOUNTS AND HITCH BALLS

## 2-1/2"

### Ball Mounts



#### COLOR CODING GUIDE

Fits 1-1/4"  
Hitch Boxes

Fits 2"  
Hitch Boxes

Fits 2-1/2"  
Hitch Boxes



## 1-1/4"

### Shank Hitch Balls

#### CLASS V - HEAVY DUTY BALL MOUNTS

Part Number	Box Opening Dimensions	Hitch Ball Hole Size	Length	Drop	Rise	Capacity
<b>7028100</b>	2-1/2" x 2-1/2"	1-1/4"	9-1/2"	3"	1-1/2"	14000/1400 lb
<b>7028200</b>	2-1/2" x 2-1/2"	1-1/4"	10"	5"	3-1/2"	13000/1300 lb
<b>7028300</b>	2-1/2" x 2-1/2"	1-1/4"	10-1/2"	7-3/4"		13000/1300 lb
<b>7028700</b>	2-1/2" to 2" Adapter					

#### CLASS V CHROME HITCH BALLS

Part Number	Ball Diameter	Shank Diameter	Shank Length	Lift	Capacity
<b>7028400</b>	2-5/16"	1-1/4"	2-3/4"	Standard	12000 lb
<b>7028500</b>	2-5/16"	1-1/4"	2-3/4"	Standard	14000 lb
<b>7028600</b>	2-5/16"	1-1/4"	2-3/4"	Standard	17000 lb
<b>7033930</b>	2"	1-1/4"	2-3/4"	Standard	8000 lb

# BALL/HOOK AND CLEVIS MOUNT

## TRI-BALL MOUNT WITH HOOK

- 2" x 2" shank
- Balls and hook are chrome plated

Part Number	Hitch Ball	Length	Capacity
<b>7031400</b>	1-7/8"	8"	2000/200 lb
	2"	8"	6000/600 lb
	2-5/16"	8"	10000/1000 lb
	Hook	8"	10000 lb

## BALL MOUNT WITH HOOK

- 2" x 2" shank

Part Number	Hitch Ball	Length	Capacity
<b>7051900</b>	2"	8"	8500/850 lb
	Hook	8"	10000 lb



CHROME

## CLEVIS AND HITCH BALL

**7022800** Receiver mount clevis and ball mount combo

- Includes 2" zinc hitch ball and 5/8" pin & clip
- 6000 lb gross trailer weight rating.
- 600 lb tongue weight rating. 6000 lb clevis mount rating
- Clevis requires a 1" clevis pin - sold separately
- 2" x 2" shank

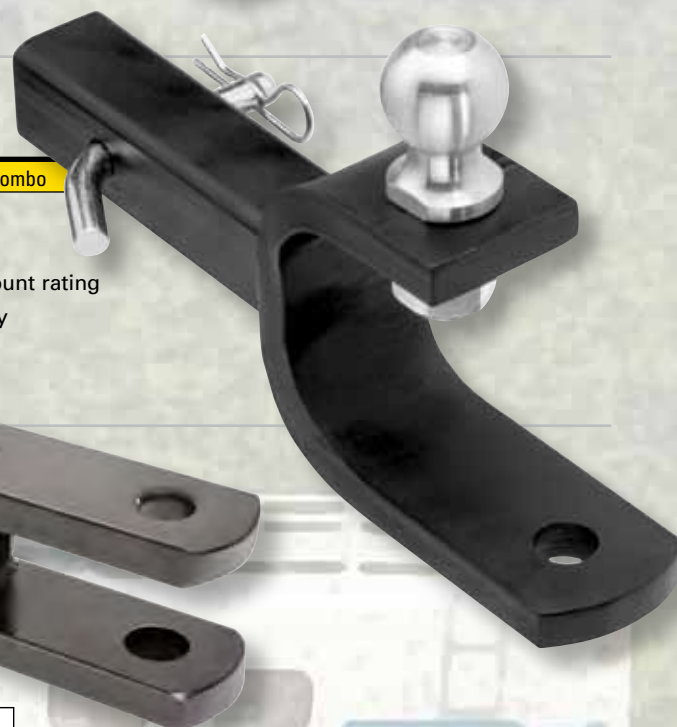

## RECEIVER MOUNT CLEVIS

- Maximum trailer - 6000 lb, Maximum tongue - 600 lb
- 2" x 2" shank

**8040900** Receiver mount clevis

## 1" DIAMETER CLEVIS PIN

- Heat treated grade 8 steel
- Comfortable soft grip handle
- Includes cotter pin
- 4-3/4" effective length

**7031700** Clevis pin

## STEERING WHEEL LOCKS

Auto Theft Security starts with REESE Towpower® SureLok® Steering Wheel Locks. These three state of the art steering wheel disabling designs represent the latest in anti-theft technology.

All locks feature square key designs, virtually eliminating lock picking. Key combinations range in the thousands and virtually eliminate like key issues. Strong, vibrant yellow color schemes prove to be a powerful deterrent for passing thieves. Built with rugged die cast lock bodies and extra wide alloy grips. *It looks like the recession is deepening for car thieves!*

**NEW!**

### THE BARRICADE™ STEERING WHEEL LOCK

- Universal fit
- Wide, rugged aluminum alloy tube design
- Steel shaft
- Extra wide alloy grips
- Square key design resists picking
- Strong visual theft deterrent

**7051100** Barricade Steering Wheel lock

**Square  
Key Design!**

**Barricade™**



# STEERING WHEEL LOCKS

**Square Key Design!**

*On Guard™*



**NEW!** **ON GUARD™ STEERING WHEEL LOCK**

- Universal fit
- Traditional Design Steel Construction
- Bright yellow theft deterrent
- Square Key Design resists picking

**7051200** On Guard Steering Wheel lock

*Rugged Die Cast Lock Body*

**Square Key Design!**

*Excalibur™*



**NEW!** **EXCALIBUR™ STEERING WHEEL LOCK**

- Universal fit
- New over-the-dash design
- Steel core construction
- Rugged die cast lock head
- Highly visible theft deterrent
- Square key design resists picking

**7051000** Excalibur Steering Wheel lock

*Rugged Die Cast Aluminum Locking Head*



# PROFESSIONAL

## The Most Theft Resistant Towing Locks Available - with Triple Protection -



### STRONGER BREAK RESISTANCE

Our patented design maintains shaft diameter for maximum strength. Higher axial and bend strengths increase theft deterrence. Reducing the shaft's diameter with "steps" creates weak points, allows easier breakage and reduces axial and bend strength.



### DUAL SELF LOCKING DESIGN

Even if the lock is broken with extremely excessive force, locking ball bearings remain extended in the shaft, disabling removal. Shaft bends and inhibits the shaft from being pulled through the receiver.



### SQUARE KEY DESIGN

Square key design virtually eliminates lock picking. Offers 1,000s of combinations to drastically reduce like (or common) key issues.

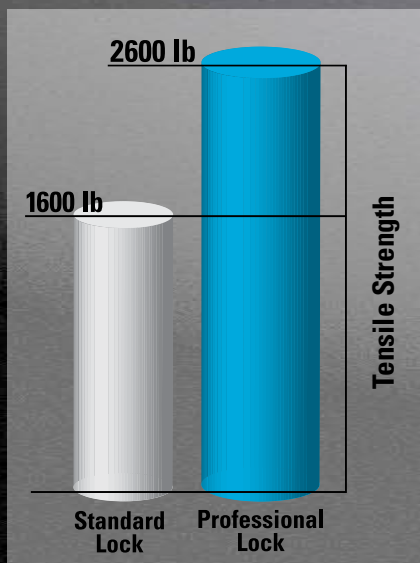

**Patented Design Eliminates Weak Points!**

Standard Lock

Ball Bearing Locking System





7030200



7030400



7030500



7030600

LOCKS, HITCH PINS & CLIPS

Reese Towpower Professional Locks are the most theft resistant locks in the towing industry. Their superior strength is derived from a patented locking design that does not require shaft diameter reductions which cause weak points. Weak points enable thieves to break the lock shaft more easily and escape with your trailer.

**CLASS III & IV PROFESSIONAL LOCKS**

<b>7030200</b>	5/8" diameter Stainless Steel Professional Receiver Lock
<b>7030300</b>	5/8" diameter Professional Receiver Lock
<b>7030400</b>	5/8" diameter Bent Pin Professional Receiver Lock
<b>7030600</b>	5/8" diameter Professional Receiver Lock and Coupler Lock

**COUPLER LOCK**

<b>7030500</b>	Professional Coupler Lock
----------------	---------------------------

**Maximum Anti-Theft Security**

## HITCH PINS & CLIPS

**Comfort  
GRIP!**



7009100

7009200

7010500



7057700

### CLASS I & II RECEIVER PINS - PACKAGED

- Bright Zinc Finish

**7009100** 1/2" diameter pin and clip with black comfort grip

**7010600** 1/2" diameter pin and clip

### CLASS III, IV & V RECEIVER PINS - PACKAGED

- Bright Zinc Finish

**7009200** 5/8" diameter pin and clip with black comfort grip

**7010500** 5/8" diameter pin and clip

**7033100** 5/8" diameter pin and clip for 2-1/2" receiver hitch, 3-1/2" span

### HEAVY DUTY PIN AND CLIP

- 3-1/2" span for 2-1/2" hitches
- Rugged clip hole

**7057700** Heavy duty pin and clip

### 3 PACK COMFORT GRIP CLIPS

**7021300** 3 pack comfort grip clips



7014500

7021200

### ANTI-THEFT RECEIVER PINS - WITH LOCK

- Bright Zinc Finish

**7014500** 5/8" 1 - piece hitch pin with swivel latch and brass lock

**7021200** 1/2" or 5/8" 2 - piece hitch pin w/ swivel latch and brass lock & sleeve converts 1/2" pin to 5/8"



7007100

7006700

### ANTI-THEFT RECEIVER PINS\*

- Bright Zinc Finish

**7006700** 1/2" or 5/8" 2 - piece hitch pin w/ swivel latch & sleeve converts 1/2" pin to 5/8"

**7007100** 5/8" 1 - piece hitch pin with swivel latch

**7007200** 1/2" 1 - piece hitch pin with swivel latch

**7007300** 5/8" 1 - piece stainless steel hitch pin with swivel latch

\* Lock sold separately



### SLEEVED RECEIVER PIN & CLIP

- Bright Zinc Finish

**7006800** 1/2" or 5/8" 2 - piece hitch pin w/ sleeve converts 1/2" pin to 5/8"

# RECEIVER LOCKS

## **BALL MOUNT LOCK**

- Flat key design, keys can be copied by most retailers
- Includes two keys and vinyl lock cover
- Chrome Plated

**7006400** Class I & II receivers and fifth wheel base rails – 1/2" diameter, 3-1/4" working area

**7006500** Class III, IV receivers – 5/8" diameter



## **DUAL, BENT PIN RECEIVER LOCK**

- Convenient Push-button lock mechanism
- Flat key design
- Rubber cap keeps dirt out
- Fits Class I/II or III/IV receivers

**7006000** Dual, bent pin lock interchangeable to 5/8" & 1/2", Chrome plated

**7000400** Stainless steel dual, bent pin lock interchangeable to 5/8" & 1/2" 



## **DUAL, BENT PIN STYLE COMBO PACK**

- Dual pins are interchangeable for 5/8" & 1/2" use
- Push-button lock mechanism
- Flat key design
- Rubber cap keeps dirt out
- Chrome plated
- Fits Class I/II or III/IV receivers

**7006100** Dual, bent pin lock (5/8" & 1/2") & brass coupler lock



## **2-PACK SECURITY LOCK SET**

- Fits both 5/8" & 1/2" openings
- Use for adapters requiring both size hitch pins

**7023900** 2-Pack Security Lock Set





## ELITE RECEIVER LOCKS



### REESE TOWPOWER ELITE RECEIVER LOCKS

- Virtually pick proof Square Key Design
- Push-button lock mechanism
- Rubber cap keeps dirt out
- 7039100 features Sure Grip cushion grip
- Fits 5/8" or 1/2" receiver pin holes

**7039000** ELITE Black Nickel sleeved barrel receiver lock

**7039100** ELITE Sure Grip cushion grip barrel receiver lock



*Black Nickel*

7039000

7039100

*Sure Grip*

# BARREL STYLE RECEIVER LOCKS

## BARREL STYLE RECEIVER LOCKS

- Fits 5/8" or 1/2" pin holes
- Push-button lock mechanism
- For use on Class I/II or III/IV receivers
- Rubber cap keeps dirt out
- Bend proof tubular key

- 7005600** Sleeved barrel chrome receiver lock
- 7010100** Stainless steel sleeved barrel receiver lock



## BARREL STYLE LOCK COMBO PACK

- Fits 5/8" or 1/2" pin holes
- Push-button lock mechanism
- For use on Class I/II or III/IV receivers
- Rubber cap keeps dirt out
- Bend proof tubular key

- 7010200** Sleeved barrel and coupler lock
- 7005900** Stainless steel sleeved barrel & coupler lock



## CLASS V BENT PIN STYLE RECEIVER LOCK

- 3-1/2" span for 2-1/2" square tube receiver hitches
- Fits 5/8" pin holes
- Push-button lock mechanism
- For use on Class V receivers
- Rubber cap keeps dirt out

- 7033300** Class V bent pin chrome receiver lock



## CLASS V RECEIVER LOCKS

- 3-1/2" span for 2-1/2" square tube receiver hitches
- Fits 5/8" pin holes
- Push-button lock mechanism
- For use on Class V receivers
- Rubber cap keeps dirt out
- Bend proof tubular key

- 7033200** Class V barrel chrome receiver



## CLASS V PIN & CLIP

- 3-1/2" span for 2-1/2" square tube receiver hitches
- Fits 5/8" pin holes
- For use on Class V receivers
- Rubber cap keeps dirt out

- 7033100** Class V zinc finish receiver pin and clip

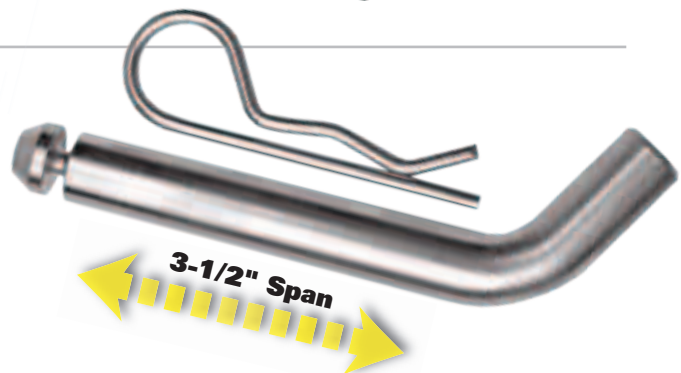

## COUPLER LOCKS & COMBO PACKS

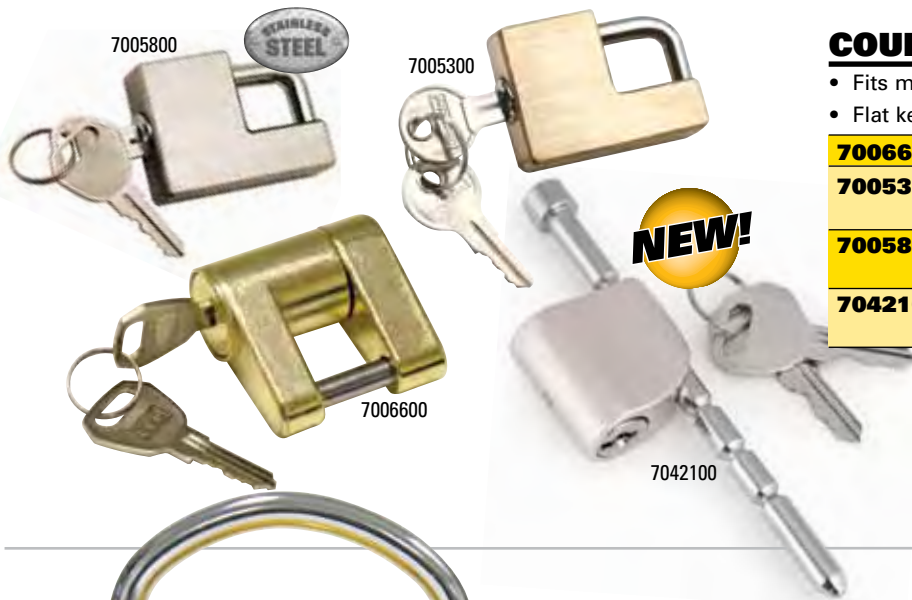

### COUPLER LATCH LOCKS

- Fits most couplers
- Flat key design

**7006600** Trailer coupler lock

**7005300** Adjustable brass coupler lock  
adjusts 5/8" to 1"

**7005800** Adjustable stainless steel coupler lock  
adjusts 5/8" to 1"

**7042100** Adjustable brushed silver coupler lock  
adjusts 5/8" to 3"



### UNIVERSAL COUPLER LOCK

- Heavy duty die cast steel design
- Ratchet design with eleven locking positions
- Fits 1-7/8", 2" and 2-5/16" couplers
- Provides security for trailer when in storage

**72783** Universal coupler lock

### BARREL STYLE LOCK COMBO PACK

- Fits 5/8" or 1/2" pin holes
- For use on Class I/II or III/IV receivers
- Push-button lock mechanism with rubber cap to keep dirt out

**7010200** Sleeved barrel chrome receiver lock and coupler lock

**7005900** Stainless steel sleeved barrel and coupler lock (7010100 & 7005800)



Keyed  
Alike!



7005900



Keyed  
Alike!

### TOW AND STORE ANTI-THEFT LOCK KIT

- Complete security when towing or storing
- Includes Universal Coupler Lock (72783) to secure trailer when not in use
- Brass Coupler Lock (7005300)
- Dual Bent Pin Lock fits both 5/8" and 1/2" receivers (70060), Chrome plated, Convenient push button operation, Rubber caps keeps dirt out

**7014700** Tow and Store Lock Kit

# LOCKS & ACCESSORIES

## EASY ACCESS LOCKS

- 360° Rotating head for easy lock access
- Integrated key slot cover helps protect lock from dirt
- Chrome plated

**7009300** 1/2" & 5/8" Sleeved easy access lock

**7001100** Easy Access coupler lock

**7031500** Easy Access Adjustable coupler lock



Premium Plastic Key Grips



360° Rotating Head for easy lock access

Integrated key slot cover helps protect lock from dirt

LOCKS, HITCH PINS & CLIPS

## ANTI-RATTLE HITCH PIN™

- Receiver lock Anti-Rattle Hitch Pin™ for 2" receivers
- Barrel lock included
- For use with hollow shank only
- Chrome plated

**7023500** Anti-rattle hitch pin™ - Class II-IV



## SPARE TIRE CARRIERS

- Mounts to trailer frame
- Fits most RV, marine and utility trailers
- Heavy duty 1/2" diameter construction
- Fits 8, 9, 12, 13, 14, and 15 inch wheels
- 4 or 5 lug rims
- Chrome plated

**74247** Economy spare tire carrier

**7019200** Marine spare tire carrier with locking levers and lock

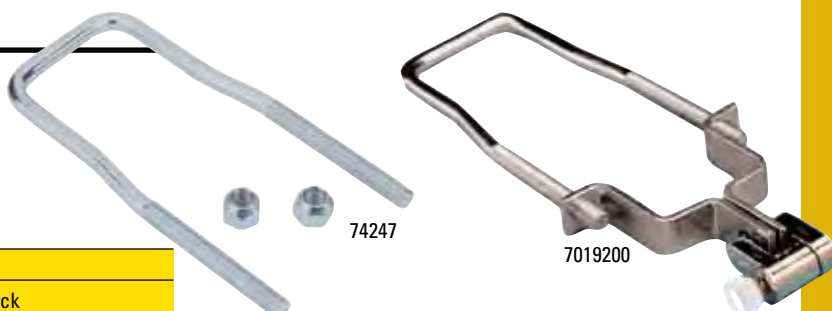

# CABLE LOCKS

7037030

7037130

7037230

7037530

7037630



7037430

7037930



7038130

7038230



7036930



## LOCKING CABLES

Part Number	Cable Diameter	Cable Length	Lock Type	Security Level	Special Feature
<b>7037130</b>	5/16"	5 ft.	Combo	2	L.E.D. Light
<b>7037030</b>	5/16"	5 ft.	Combo	2	
<b>7036930</b>	5/16"	6 ft.	Square Key	2	3 Pack, Keyed Alike
<b>7037230</b>	5/16"	5 ft.	Square Key	2	Bike Bracket
<b>7037530</b>	1/2"	5 ft.	Combo	3	Bike Bracket
<b>7037630</b>	3/8"	6 ft.	Combo	3	Bike Bracket
<b>7037930</b>	3/8"	6 ft.	Square Key	3	Bike Bracket
<b>7037430</b>	1/2"	5 ft.	Square Key	3	
<b>7038130</b>	11/16"	3 ft.	Square Key	4	
<b>7038230</b>	3/4"	3 ft.	Square Key	5	

**Virtually  
Pick Proof  
Square Key  
Design**

## 1 CABLE & LOCK SECURITY

Take the next step in security with Reese® SureLok™ security cables. Virtually pick proof locks with "square key technology" and resettable combinations raise the bar in protecting your essentials. With a broad security range from light to extra heavy duty, REESE® Towpower SureLok™ meets all of your security cable needs.

# CABLE LOCKS

## U-LOCKS AND CABLES & U-LOCKS

Part Number	Shackle Dia.	Shackle Opening	Cable Length	Cable Dia.	Security Level
<b>7038300</b>	1/2"	2" x 2"	-	-	4
<b>7038800</b>	9/16"	4.5" x 5"	-	-	5
<b>7038700</b>	9/16"	4.5" x 11.5"	-	-	5
<b>7037700</b>	9/16"	4.5" x 9"	-	-	5
<b>7038000</b>	9/16"	4.5" x 9"	5 ft.	3/8"	5

High quality hardened steel shackles and virtually pick proof square key locks are earmarks of the high security Reese® Towpower SureLok™ U-Locks. With a broad range of lengths and dual securing U-Lock and cable offerings, REESE® Towpower SureLok™ supplies all your U-Lock needs.



7037700

7038700

7038000



7038300



## EASY ACCESS RECEIVER LOCK AND CABLE

- Sleeved receiver lock (1/2" & 5/8")
- Lock works with or without cable
- 12' vinyl coated steel cable
- 360° head for easy locking/unlocking
- Fully removable cable

**7031600** Easy Access Sleeved Receiver Lock and Cable



7031600

Great For: Bike Racks & Cargo Trays!

7033830



7034030



## SPARE TIRE SECURITY

- Heavy duty
- 5/16" diameter x 4' vinyl coated braided cable
- 40mm laminated steel padlock
- Security for ladders, utilities, spare tires, tools

**7033830** Spare Tire Security - Cable and Lock

## CABLE W/INTEGRATED 90° LOCK

- 9/16" diameter x 6' vinyl coated braided cable
- Integrated Lock
- Great for securing ATVs, utilities, tools

**7034030** Cable with Integrated 90° Lock

LOCKS, HITCH PINS & CLIPS

4

5

## RETRACTABLE CABLES

### SURELOK™

Loop it, lock it and leave it. Lock all your gear with the SureLok™ retractable cable system. Its simple design secures everything from ATVs and bikes to portable tools, generators and camping gear. Housed in a sealed compact case, SureLok™ attaches to your vehicle frame by bolting or by using one of several available mounting kits. Just extend the retractable vinyl coated steel security cable, loop it through your items and lock it with our included padlock. SureLok™ uses state of the art components and a highly durable polymer housing, so it is maintenance free and easy to use. Safety brakes slow the retraction of the vinyl coated security cable while stainless steel cable ends protect it from damage and use.



Slide cable through your gear to the locking bracket

Also fasten lock back onto cable



#### Optional Mounting Kits Available



TL005 Receiver Hitch Kit



TL006 Truck Stake Kit



TL007 Trailer U-Bolt Kit



TL008 RV Bumper Kit



TL009 ATV/UTV Kit



TL010 Tool Box Kit

#### SURELOK™ RETRACTABLE CABLE LOCKING SYSTEM

**7032100** SureLok™ Retractable Cable Security System, 15' Cable

**7033500** SureLok™ Cable Security System and Tool Box Mounting Grommet

**TL005** Receiver Hitch Mounting Kit

**TL006** Truck Stake Hitch Mounting Kit

**TL007** Trailer U-Bolt Mounting Kit

**TL008** RV Bumper Mounting Kit

**TL009** ATV/UTV Mounting Kit

**TL010** Tool Box Mounting Kit

# KEY-LOK™ & DUAL-FIT™ COUPLERS

## DUAL-FIT KEY-LOK™ COUPLERS

- Flat key design w/dust cover
- Includes Dual-Fit Spacers
- Welded protective lock housing
- Helps prevent trailer theft

Part Number	Finish	Ball Size	Style	Channel Widths	Trailer GVW
<b>7005000</b>	ZINC	1-7/8"	Fas-Lok	2" & 2-1/2"	2000 lb
<b>7004900</b>	ZINC	2"	Fas-Lok	2-1/2" & 3"	3500 lb



**Key-Lok™**



7005000

## DUAL-FIT™ FAS-LOK® COUPLERS

- Dual-Fit Spacers ensure a proper fit, fewer returns
- Tethered pin included for added safety

Part Number	Finish	Ball Size	Style	Channel Widths	Trailer GVW
<b>7004800</b>	ZINC	1-7/8"	Fas-Lok	2" & 2-1/2"	2000 lb
<b>7004700</b>	ZINC	2"	Fas-Lok	2-1/2" & 3"	3500 lb



7004800

**Dual-Fit™**

## FAS-LOK® CLASS I COUPLERS - PACKAGED

Part Number	Finish	Ball Size	Style	Channel Width	Trailer GVW
<b>74338</b>	ZINC	1-7/8"	Fas-Lok	2"	2000 lb
<b>74040</b>	ZINC	1-7/8"	Fas-Lok	2-1/2"	2000 lb
<b>74783</b>	ZINC	1-7/8"	Fas-Lok	3"	2000 lb



74338

## FAS-LOK® CLASS II COUPLERS - PACKAGED

Part Number	Finish	Ball Size	Style	Channel Width	Trailer GVW
<b>74042</b>	ZINC	2"	Fas-Lok	2-1/2"	3500 lb
<b>74280</b>	ZINC	2"	Fas-Lok	3"	3500 lb

## COUPLER - REPAIR KITS

<b>74796</b>	COUPLER REPAIR KIT (CLASS I)
<b>74797</b>	COUPLER REPAIR KIT (CLASS II)
<b>7044900</b>	COUPLER PIN AND CHAIN

7044900



**NEW!**

## CLASS III & IV COUPLERS - BULK

Part Number	Finish	Ball Size	Style	Channel Width	Trailer GVW
<b>33305 1360</b>	PRIMER	2"	Weld-on	A-frame	5000 lb
<b>44305R1360</b>	PRIMER	2-5/16"	Weld-on	A-frame	10000 lb



33305 1360



## WINCHES

## SINGLE

**SINGLE SPEED TRAILER WINCHES**

- Includes comfort grip handle for a positive hold while cranking
- Zinc-plated finish for superior corrosion resistance
- Full-length drum bushing and oil impregnated shaft bushings minimize maintenance
- High carbon steel gears to resist wear and last longer
- Easy-to-use two-way ratchet

Part #	Capacity	Gear Ratio	Ratchet Type	Rope	Drum Storage Cable	Strap	Strap Included
<b>74337</b>	600	3.1:1	Two-way	36' x 1/4"	N/A	15' x 2"	NO
<b>74418</b>	1100	4.1:1	Two-way	36' x 1/4"	N/A	15' x 2"	NO
<b>74556</b>	1100	4.1:1	Two-way	30' x 5/16"	N/A	20' x 2"	NO
<b>74419</b>	1300	4.1:1	Two-way	30' x 5/16"	N/A	20' x 2"	NO
<b>74329</b>	1500	4.1:1	Two-way	20' x 5/16"	N/A	20' x 2"	NO
<b>74336</b>	20 Ft. Winch Strap and Hook						

74337

74418  
74556

74119

74329

# SPEED

## FULTON WINCHES



T1100Z0101

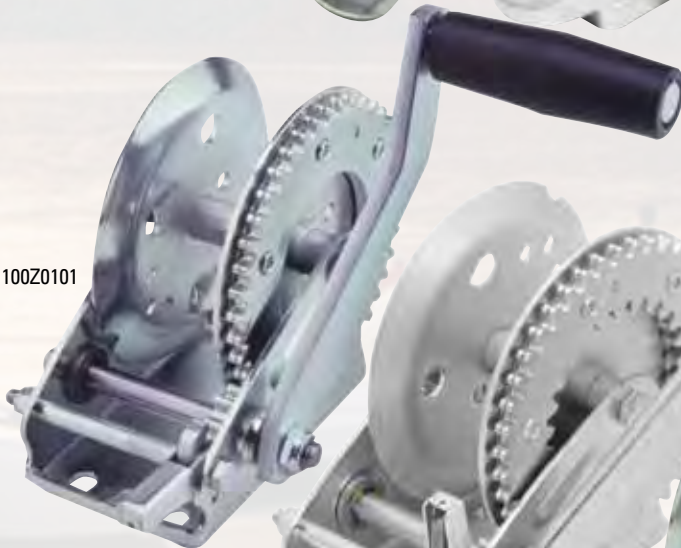

T1300 0101

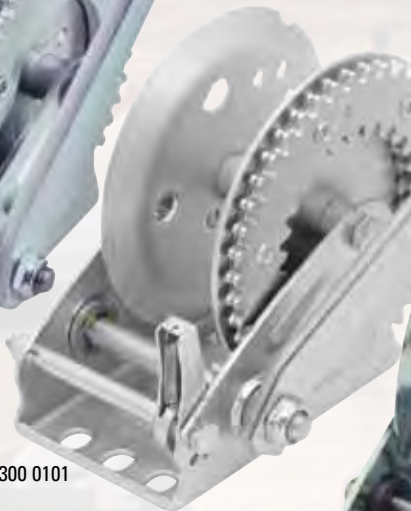

T1500Z0101



# FULTON®

### SINGLE SPEED TRAILER WINCHES

Part #	Capacity	Gear Ratio	Ratchet Type	Rope	Drum Storage	Cable Strap	Strap Included
<b>7016800</b>	1400	4.1:1	Two-way	N/A	N/A	20' x 2"	YES
<b>FW20000101</b>	2000	3.1:1	Two-way	36' x 1/4"	N/A	15' x 2"	YES
<b>XLT14ZB101</b>	1400	4.1:1	Two-way	N/A	N/A	20' x 2"	YES
<b>T1100Z0101</b>	1100	4.1:1	Two-way	30' x 5/16"	N/A	20' x 2"	YES
<b>T1300 0101</b>	1300	4.1:1	Two-way	30' x 5/16"	N/A	120' x 2"	NO
<b>T1500Z0101</b>	1500	4.1:1	Two-way	20' x 5/16"	N/A	20' x 2"	YES
<b>T1602 0101</b>	1600	5.1:1	Two-way	20' x 7/16"	N/A	20' x 2"	NO
<b>T1801 0101</b>	1800	5.1:1	Two-way	20' x 7/16"	N/A	20' x 2"	NO
<b>T1801Z0101</b>	1800	5.1:1	Two-way	20' x 7/16"	N/A	20' x 2"	YES

T1602 0101  
T1801 0101  
T1801Z0101



# FULTON WINCHES

# TWO

T2005 0101

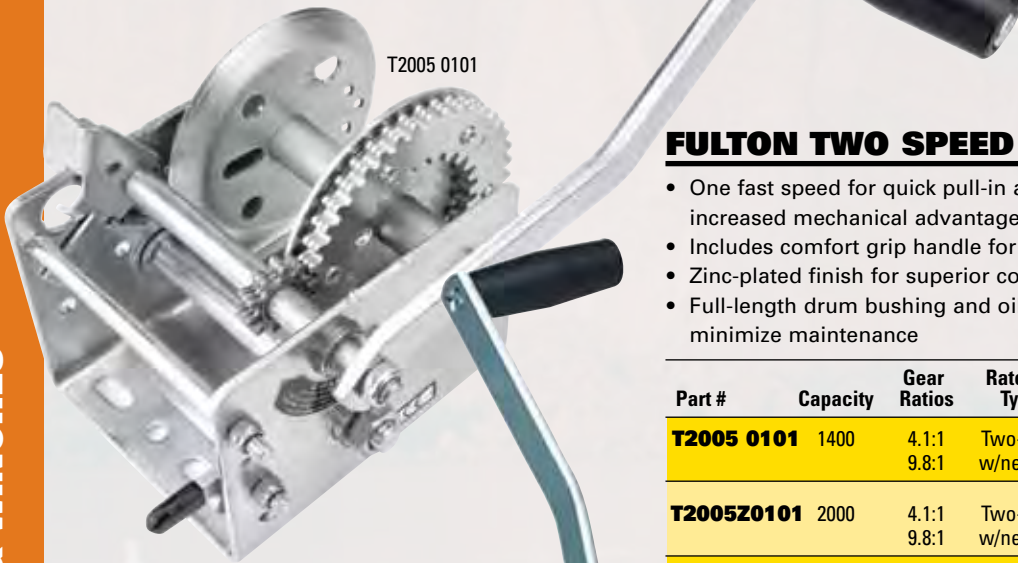

## FULTON TWO SPEED TRAILER WINCHES

- One fast speed for quick pull-in and a second low speed for increased mechanical advantage
- Includes comfort grip handle for a positive hold while cranking
- Zinc-plated finish for superior corrosion resistance
- Full-length drum bushing and oil impregnated shaft bushings minimize maintenance

Part #	Capacity	Gear Ratios	Ratchet Type	Rope	Drum Storage Cable	Strap	Strap Included
<b>T2005 0101</b>	1400	4.1:1 9.8:1	Two-way w/neutral	20' x 7/16"	N/A	N/A	NO
<b>T2005Z0101</b>	2000	4.1:1 9.8:1	Two-way w/neutral	N/A	N/A	20' x 2"	YES
<b>T2605 0101</b>	1100	5.1:1 12.2:1	Two-way w/neutral	24' x 7/16"	N/A	N/A	NO
<b>T3205 0101</b>	1300	5.1:1 12.2:1	Two-way w/neutral	N/A	100' X 7/32"	N/A	NO

T2005Z0101

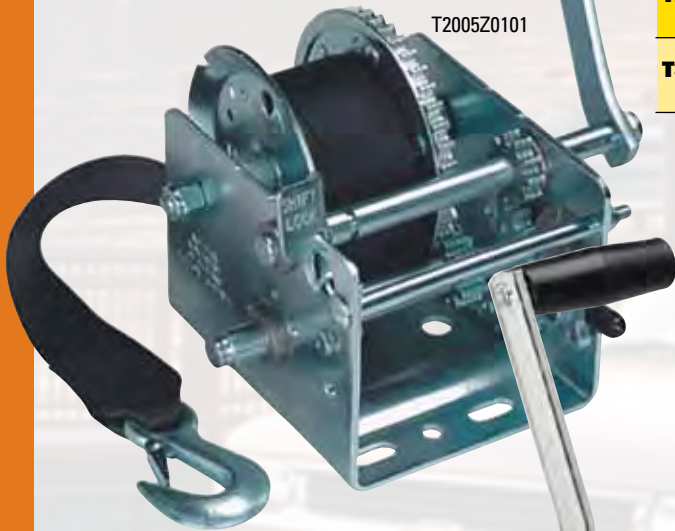

# FULTON®

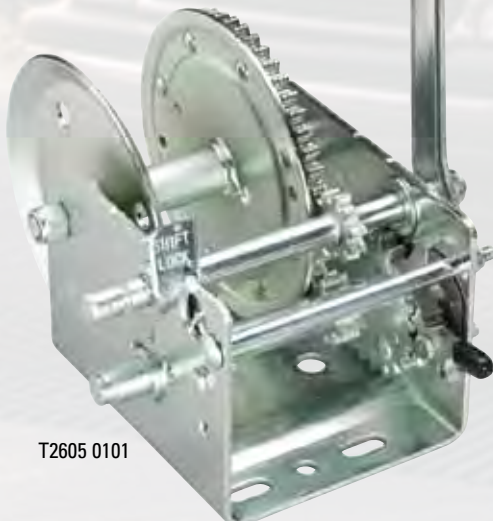

T2605 0101

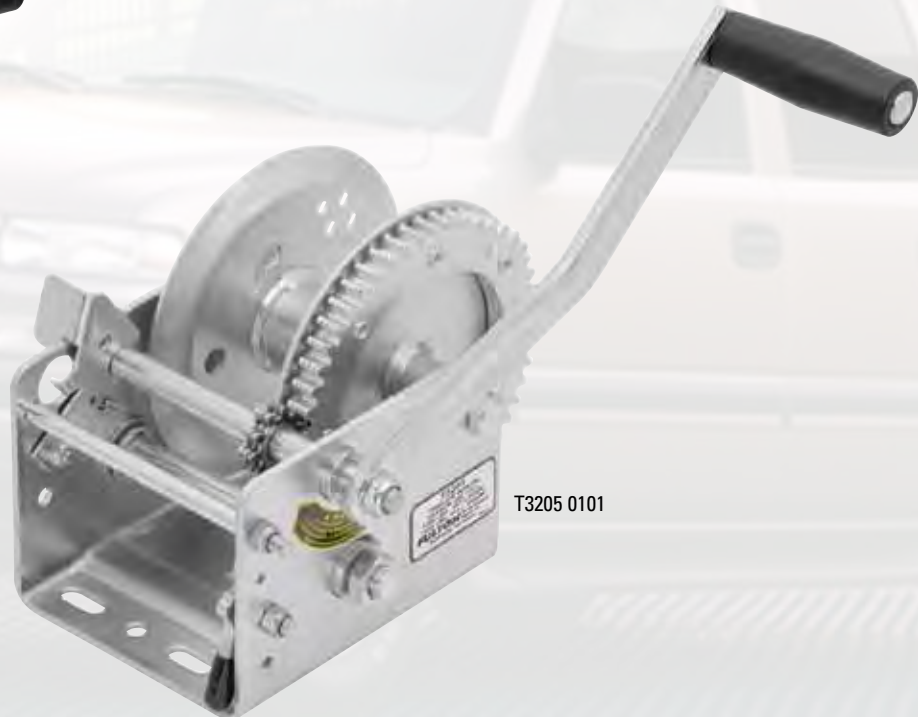

T3205 0101

# SPEED

## WINCHES



### TWO SPEED TRAILER WINCH

Part #	Capacity	Gear Ratios	Ratchet Type	Rope	Drum Storage Cable	Strap	Included
<b>74529</b>	1800	4.1:1 9.8:1	Two-way w/neutral	20' x 7/16"	N/A	N/A	NO

COUPLERS, JACKS & WINCHES



### 2000 LB CAPACITY SINGLE SPEED PORTABLE ELECTRIC WINCH

- Includes: 29 ft. galvanized steel cable and safety hook, wired remote control, 20 ft. Power cable, steel mounting plate, manual hand crank & knob
- Mounts to hitch ball for quick and easy temporary use
- Permanent platform mounting for trailers, flatbeds, trucks and more
- **CAPACITIES:**  
6000 lb-Rolling, 5000 lb-Marine, 2000 lb-Pulling

Part #	Description
<b>7033600</b>	2000 lb Portable Electric Winch



Recover Vehicles



Mount to Boat Trailer

Includes Cable & Hook, Remote Control, Power Cord, Mounting Plate and Manual Crank



# JACKS

## BULLDOG JACKS AND ACCESSORIES



### TOPWIND JACKS

Part No	Capacity	Description
<b>178151</b>	5000 lb	Round tube topwind jack. 15" travel. Weld-on tubular mount with 9/16" pin and foot plate.
<b>158486</b>	2000 lb	Round tube topwind jack. 15" travel. Weld-on tubular mount. 5/8" pin and foot plate.
<b>158451</b>	2000 lb	Topwind round swivel jack. 10" travel. Weld-on tubular mount with 9/16" pin and foot plate.
<b>158452</b>	2000 lb	Topwind round swivel jack. 15" travel. Weld-on tubular mount with 9/16" pin and foot plate.
<b>155032</b>	5000 lb	Topwind A-frame jack. 15" travel. Weld-on, bolt on bracket. Base not included.

### TOPWIND JACKS

Part No	Capacity	Description
<b>155022</b>	2000 lb	Topwind A-frame jack. 15" travel. Weld-on, bolt on bracket. Base not included.
<b>151401</b>	2000 lb	Topwind round jack. 10" travel. Weld-on L-bend swivel bracket assembled. Plunger pin. Base included.
<b>74415</b>	2000 lb	Reese Towpower® Industrial topwind jack with foot and mount plate. 10" travel. 5/8" diameter pull pin.
<b>74414</b>	2000 lb	Reese Towpower® Industrial topwind jack with foot and mount plate. 10" travel. 3/8" diameter pull pin.



BULLDOG jacks are tough and trusted, built with uncompromising strength and materials engineered to hold up under rigorous working conditions.

**BULLDOG Jacks Are Known For:**

- Easy cranking
- Smooth, comfortable, ergonomic design
- Dependable vertical and side load capacity
- Proven reliability for long term use at rated loads
- Precision fitted parts for extra stability



**SIDEWIND JACKS**

Part No	Capacity	Description
<b>178203</b>	5000 lb	Round tube sidewind jack. 15" Travel. Weld-on tubular mount with 9/16" pin and foot plate.
<b>158151</b>	2000 lb	Sidewind round tube mount jack. 15" Travel. 5/8" dia. pull pin. Includes foot and mount plates.
<b>158109</b>	2000 lb	Sidewind round swivel jack. 10" Travel. Weld-on tubular mount with 9/16" pin and foot plate.

**ACCESSORIES**

<b>500244</b>	2" Removable foot plate. Fits jacks with 2" inner tube. Includes latching pin.
<b>500245</b>	Removable caster w/ polywheel. 6" wheel. Rated 800 lb
<b>500180</b>	Top crank
<b>500105</b>	Sidewind crank for 170 series
<b>500171</b>	Sidewind crank for 190 series

# JACKS

## BULLDOG JACKS AND COUPLERS

182800



### SQUARE TUBE DIRECT WELD JACKS

Part No	Capacity	Description
<b>190754</b>	8000 lb	Square tube direct weld jack. Sidewind crank. 15" Travel. Drop leg with heavy-duty base, provides 13.5" of additional adjustment.
<b>190704</b>	8000 lb	Square tube direct weld jack. Topwind crank. 15" Travel. Drop leg with heavy-duty base, provides 13.5" of additional adjustment.
<b>182800NH</b>	12000 lb	Square tube jack. Direct weld with spring return. 12.5" travel. Drop leg with standard disc foot provides 13.5" of additional extension. Handle sold separately.

**ROUND GOOSENECK ADJUSTABLE COUPLER**

- Easy-grip locking handle is accessible from any position, even with gloves
- Self-centering locking plate lets you miss the ball by more than an inch
- Tight ball fit reduces jamming when changing speeds or on rough roads
- Heavy-duty construction provides unmatched strength
- User-friendly design is simple to use
- Quick to hook up and disconnect
- Easy vertical 8" adjustment
- Overall retracted height: 29.2"

0287640300



Part No	GVW	Description
<b>0287640300</b>	20000 lb	Adjustable Gooseneck Coupler. 2-5/16" Ball Size. Primer Finish.
<b>0289340317</b>	25000 lb	Adjustable Gooseneck Coupler with cable release. 2-5/16" Ball Size. Primer Finish.



028375

028351

028352

**PRECISION MACHINED GOOSENECK COUPLER BALLS**

- Precision machined from high-strength steel bars
- Carefully shaped for years of reliable service

Part No	Rated Capacity	Ball Dia	Shank Dia
<b>028375</b>	3000 lb	2"	3/4"
<b>028351</b>	5000 lb	2"	1"
<b>028352</b>	7000 lb	2"	1" (heat treated)
<b>028400</b>	12500 lb	2-5/16"	1-1/4"

**GOOSENECK**



# HEAVY DUTY

028381



## ROUND TUBULAR TONGUE MOUNT COUPLER

- 2-1/4" OD x 1-3/4" ID, Steel Tubing

Part No	GTW	Length	Latch	Ball Size	Class
<b>028381</b>	5000 lb	10-3/4"	High Profile	2"	III

028382  
028462

## 3" SQUARE/RECTANGULAR TONGUE MOUNT COUPLERS

- For 3" square or rectangular trailer tongue

Part No	GTW	Length	Latch	Ball Size	Class
<b>028382</b>	5000 lb	16-1/4"	High Profile	2"	III
<b>028244</b>	5000 lb	16-1/4"	Pin Style	2"	III
<b>028462</b>	12500 lb	16-1/2"	High Profile	2-5/16"	N/A

028244

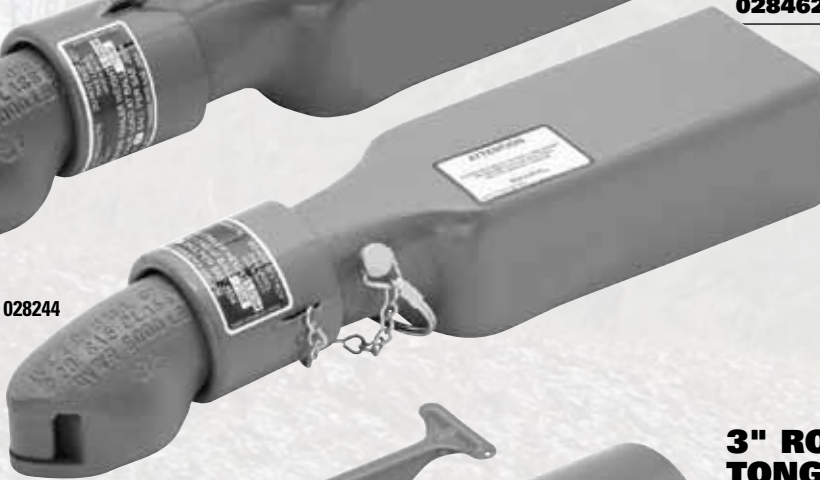

028383

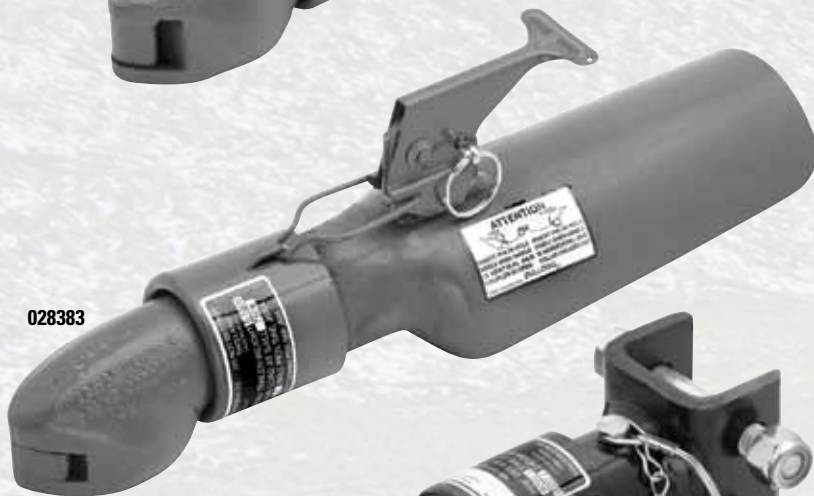

## 3" ROUND STRAIGHT TONGUE MOUNT COUPLER

- High-strength steel for 3-1/2" OD round trailer tongue

Part No	GTW	Length	Latch	Ball Size	Class
<b>028383</b>	5000 lb	16-1/4"	High Profile	2"	III

028390  
028630

## ADJUSTABLE CHANNEL MOUNT COUPLERS

- Fits inside 2-7/8" wide channel

Part No	GTW	Length	Latch	Ball Size	Class
<b>028390</b>	7000 lb	9-1/2"	Pin Style	2"	IV
<b>028630</b>	12500 lb	10"	Pin Style	2-5/16"	N/A

# COUPLERS



Designed for utility, horse/livestock, cargo and construction trailer applications. **BULLDOG** Collar-Lok® are the strongest in the industry. The **BULLDOG** design features the only automatic and continuously tight ball fit in the industry. A variety of coupler styles, tongue mounts and latches allow configurations to match virtually any trailer. Adjustable couplers assure level operation for trailers when pulled by a variety of different vehicles.

- **Easiest to use**
- **Strong in both static and dynamic loading conditions**
- **Hinged ball socket for easy hook up**
- **Clear, visual indication of proper closure**

## A-FRAME TONGUE MOUNT COUPLERS

- High-strength steel for 50° trailer tongue

Part No	GTW	Length	Latch	Ball Size	Class
<b>028384</b>	5000 lb	16"	High Profile	2"	<b>III</b>
<b>028288</b>	5000 lb	16"	Low Profile	2"	<b>III</b>
<b>028386</b>	7000 lb	16"	Low Profile	2"	<b>IV</b>
<b>028287</b>	12500 lb	16"	High Profile	2-5/16"	<b>IV</b>
<b>028463</b>	12500 lb	16-1/2"	low Profile	2-5/16"	<b>N/A</b>

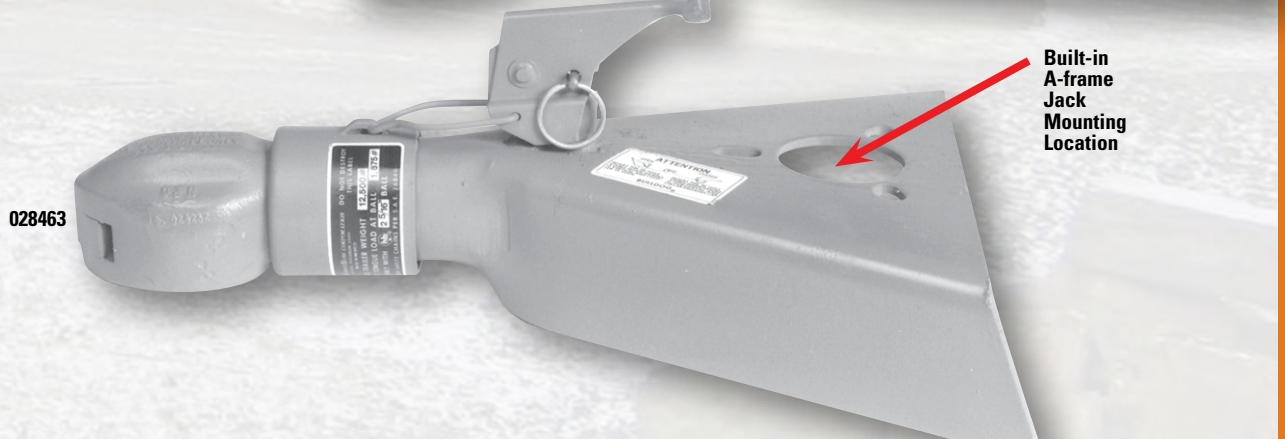

## TOP WIND & SIDE WIND JACKS



The top wind handle design on Reese Towpower swivel jacks provide easier operating by utilizing your most efficient muscles. Top wind handles also conveniently fold and lock into storage position. Side wind handles provide quick up and down action.

### SIDE MOUNT TOP WIND JACKS

- 10" travel
- Zinc finish
- 3/8" pull pin
- Bolt-on snap swivel mount
- Wire-grip knob handle

Part No.	Description	Capacity
<b>74412</b>	Side mount top wind jack with 6" reinforced poly wheel	600 lb
<b>74413</b>	Side mount top wind jack with foot plate	1000 lb

### A-FRAME DROP-THROUGH JACKS

- Features rolled acme threads & anti-friction thrust bearings
- High-strength tubing
- Primed inner and outer jack tubes
- Includes detachable foot plate

Part No.	Description	Finish	Handle	Travel	Capacity
<b>74407</b>	Top wind A-frame jack	Black	Cylinder	14"	2000 lb



### SIDE MOUNT SIDE WIND JACK

- Heavy-duty swivel mechanism for ease of operation
- Operates in seconds with new pull-pin swivel release
- 1:1 sidewind gear ratio provides fast, easy jack operation
- Fits up to 3" x 5" tongue frames, 1/2" pull pin
- Wire-cylinder grip handle
- 10" travel

Part No.	Description	Capacity
<b>74410</b>	Snap-ring swivel mount side wind jack with 6" caster wheel (zinc plated)	1000 lb
<b>74557</b>	Same as above in Marine packaging	1000 lb



### DUAL WHEEL SWING AWAY TRAILER JACK

- 10" Travel
- 22.7" Total Extension
- Fits up to 3" x 5" Trailer Tongues
- Zinc Finish

Part No.	Description	Travel	Capacity
<b>7042900</b>	Dual Wheel Swing Away Jack	10"	1000 lb



7042900

74410  
74557

74407

74412

74413

# POWERED JACK

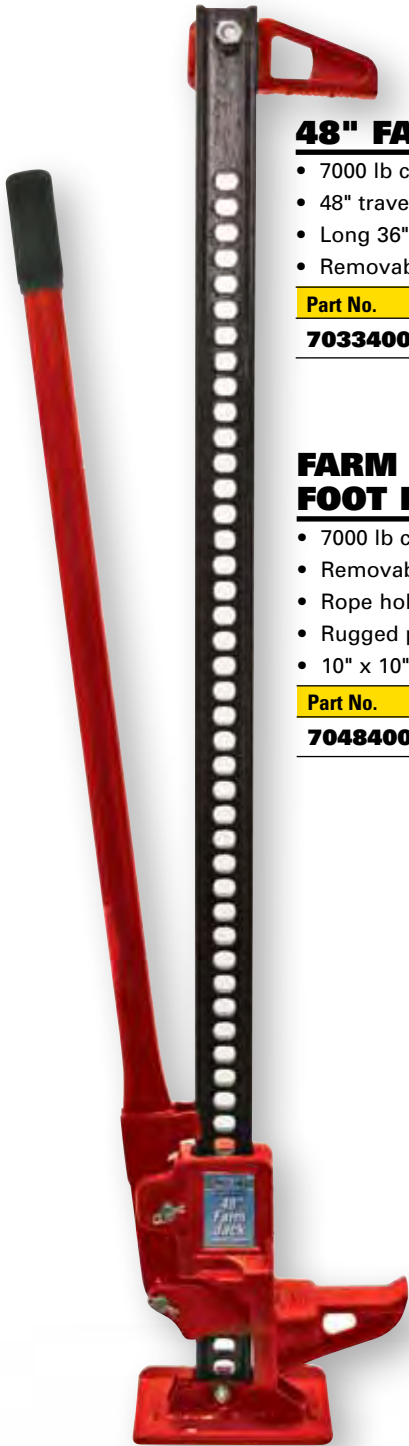

## 48" FARM JACK

- 7000 lb capacity
- 48" travel
- Long 36" handle for ease of use
- Removable handle and clamp

Part No.	Description	Finish	Handle	Travel	Capacity
<b>7033400</b>	48" Farm Jack	Red/Black	36"	48"	7000 lb

## FARM JACK FOOT PLATE

- 7000 lb capacity
- Removable locator ring
- Rope holes
- Rugged polypropylene plastic
- 10" x 10" x 1"



Part No.	Description
<b>7048400</b>	Farm Jack Foot Plate

## 2500 LB POWERED JACK

- 12V DC
- Built-in circuit breaker
- Connects directly to trailer battery/wiring
- Easily mounts to trailer (hardware included)
- Includes manual crank handle

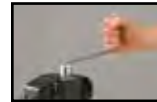

Part No.	Description	Finish	Travel	Capacity
<b>7036400</b>	Powered A-frame jack	Black	18"	2500 lb



# **NEW!** TransRACK



**No Drill  
Clamps for  
Adjustable  
Installation**



**Streamlined  
Cross Bars**



**Adjustable  
Load Stops  
w/Fast & Easy  
Bar Clamps**



**Your Load  
is Secure!**



**800 lb  
Capacity  
Load 'er Up!**

**4 Load Stops**



**4 End Caps**

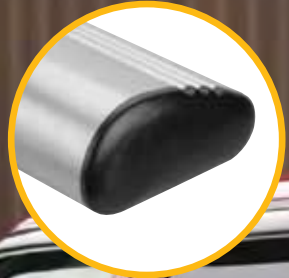

**8 Double  
Lock Anchor  
Points**



**TOWING ACCESSORIES**

# Cargo Truck Rack

**FULLY ADJUSTABLE**

- One Size Fits All Pick Up Trucks - Long and Short Bed
- High Quality Aluminum
- Aerodynamic Design

- 800 lb Load Capacity
- No Drill Installation and Easy Adjustability



**TRANSRACK CARGO TRUCK RACK**

**7054700** TransRACK Cargo Truck Rack System, 800 lb Capacity

**TOWING ACCESSORIES**

**NEW!** A Complete Line of Accessories to Choose From



**TRIMMER RACK**

- 4 double lock anchor points for no drill installation
- Black powder coat finish
- Optional permanent mount and top rail kit attachment
- Mounting hardware inc.

**7055000** Trimmer Rack



**TOOL RACK**

- 4 double lock anchor points for no drill installation
- Ideal for long handle shovels and rakes, holds 6
- Black powder coat finish
- Includes rubber grommets

**7055100** Tool Rack



**CONDUIT CARRIER**

- Attaches to cross bars
- Includes aluminum door, end cap & saddle brackets - U bolts & hardware
- For use with 6" diameter PVC pipe (not included)

**7054900** Conduit carrier



Available Fall 2012

**TOP RAIL KIT**

- Increases versatility
- Complete with over cab cross member
- Natural aluminum finish
- Extends stabilizing reach for long objects

**7055200** Top rail kit

## CHOCKS & CASTER WHEELS



7000300

### DOCK CHOCK

- Reduces risk of trailer roll
- Fits most trailer wheels
- Durable high impact polymer
- Includes mounting holes

**7000300** Heavy duty mountable dock chock



7000100

### WHEEL CHOCKS

- Reduces risk of trailer roll
- Fits trailer wheels up to 17"
- 8.25"L x 5.75"H x 6"W
- High impact polymer
- Includes mounting holes

**7000100** Wheel chock 2 piece set - 6 sets/ master

**7022700** Wheel chock 2 piece set - 4 sets/master



### CASTER WHEEL

- 6" x 2" reinforced poly-wheel
- Provides easy roll and good ground support
- Zinc plated for corrosion resistance
- Easily removed
- Pin and clip included

**74326** 1000 lb (fits 74404)



### FOOTPLATE

- Bright zinc finish
- Snap ring included

**500244** Detachable disc foot - 2.1" height

# TOWING ACCESSORIES



74099



705150

700600



74514

## RECEIVER TUBE COVERS - CLASS III / IV

<b>74099</b>	Black nylon for 2"
<b>74514</b>	Tethered rubber hitch receiver cover with 4-way flat holder
<b>74547</b>	Replacement receiver plug for 2"
<b>700600</b>	Rubber receiver plug for 2"
<b>705150</b>	Rubber receiver plug for 1-1/4"
<b>7023100</b>	Distinctive chrome collar and rubber receiver plug for 2"



7023100



74547

## HITCH BALL COVER

- Fits 1-7/8" and 2" hitch balls
- Includes a 4-way flat wiring mounting pocket
- Prolong life of hitch ball
- Prevents accidental grease stains



**7013100** Ball cover 1-7/8" and 2"

## HITCH BALL WRENCH

- 1-1/8" & 1-1/2" Wrench ends fit the most popular hitch ball nut sizes
- 19" long



**74342** Hitch ball wrench

## HITCH BALL BUSHINGS

- Allows 3/4" shank hitch balls to be used with ball mounts with 1" shank holes

**58109** Reduces from 1" to 3/4"  
**72800** Reduces from 1" to 3/4" - for InterLock™ Ball Mounts



58109



72800





## TOWING ACCESSORIES



### HITCH BALL LUBRICANT - 2 PACK

- Water resistant
- Reduces coupler and ball wear
- Helps fight corrosion

**7029600** 2 Pack - Single dose hitch ball lubricant



74176

### WHEEL BEARING PROTECTORS & KITS

- Permits Easy Lubrication for Longer Life
- Keeps Water and Dirt Out
- Easy to Install

**72789** Wheel Bearing Kit - 3/4" - Single

**72790** Wheel Bearing Kit - 1-1/4" - Single

**72791** Wheel Bearing Kit - 1" - Single

**74176** Wheel Bearing Protector Set - 1.781" dia. Hub

**74177** Wheel Bearing Protector Set - 1.980" dia. Hub

**7036700** Wheel Bearing Protector Set - 2.328" dia. Hub

**74317** 1-3/8" and 1-1/16" Wheel Bearing Kit with Dust Cover



### TOWING SAFETY CABLES

- 5000 lb rating 40" long w/vinyl coating, protects from rust & corrosion
  - Self coiling cables & spring loaded safety latch keeps hook in place
  - Heavy duty forged hooks
- Set of 2

**7007500** Towing safety cables



### STEP BUMPER RECEIVER

- Accepts 2" hitch bars
- Tongue weight 350 lb; GTW 3500 lb

**81378** Class II step bumper receiver hitch  
(Not for use with weight-distributing equipment)



# TOWING ACCESSORIES



7014200

## ADJUSTABLE TOW BAR CLASS III - 5000 LB CAPACITY

- Includes 2" coupler and one set of universal bumper brackets
- Base plate may be required
- Limited lifetime warranty
- Tow bar chains sold separately



Adjustable tow bar folds closed for easy storage

Solid Rail	Split Rail	
<b>74344</b>	<b>7014200</b>	Adjustable tow bar; 5000 lb GVW



74344

7014200

## TOW BAR CHAINS - 5000 LB CAPACITY

- Kit includes:
  - 4 - 30", 5000 lb chains
  - 4 - 5/16" Quick Links
  - 4 - U-Bolts and locknuts
- Required by law in most states

<b>7024800</b>	Tow bar chains
----------------	----------------



## 2 TON STEEL CABLE PULLER

- All Steel Construction
- Drop Forged Hooks with Spring Action Safety Latches
- Heavy Duty Double Ratchet and Pawl
- Pulling, Tightening, Lowering
- Non-Slip Rubber Grip Handle
- Tighten Fencing
- Move Heavy Equipment & Objects
- Removing Tree Stumps and Debris
- Assist Loading Boat onto a Trailer

<b>7034100</b>	2 Ton Steel Cable Puller
----------------	--------------------------

# TOWING ACCESSORIES



## SAFETY CHAINS

- Safety chains are required by law in most states
- Cross chains when towing for added safety
- Bright zinc finish

**7025700** 2000 lb rating - 72" long chain and 2" Quick Links - open style

**74059** 5000 lb rating - 72" long chain and 2" Quick Links

**7007700** 2000 lb rating - 72" long chain and 2" S - Hooks - open style

**7007800** 5000 lb rating - 72" long chain and 2" Quick Links - open style

**72786** 5000 lb rating - 36" long chain and 1" Quick Link and 1 U-Bolt)

**7007600** 5000 lb rating - 36" long chain, 1" Quick Link and 1 U-Bolt) - open style



## QUICK LINKS

- For use with safety chains or as tie-downs
- Chrome finish

**7007900** 5/16", 5000 lb rating (2 links per pack) - Class III

**7008000** 1/4", 3500 lb rating (2 links per pack) - Class II



## TOW HOOK

**7007400** Black tow hook; 10000 lb rating



## RECEIVER TUBES, SIZED WITH COLLARS

**11021** 12" long for 2" hitch bars

**11080** 6" long for 2" hitch bars



## HITCH BOX EXTENSIONS

Part No.	Description	Wt. Carrying	Wt. Distributing
<b>11003</b>	14" extension only	400/4000 lb	650/6500 lb
<b>11004</b>	18" extension only	400/4000 lb	650/6500 lb
<b>11006</b>	18" extension with step	400/4000 lb	650/6500 lb

# TOWING ACCESSORIES

TOWING ACCESSORIES



## DUAL VIEW CLIP-ON TOWING MIRROR

- Fully adjustable dual mirrors maximize vision
- Adjustable security straps are non marring
- Aerodynamic design that adjusts to fit existing mirror
- Attaches to mirror in seconds

**7034200** Dual View clip-on towing mirror



Non marring adjustable security straps

## CLIP-ON TOWING MIRROR

- Arms adjust to fit many applications
- Mirror head is fully adjustable
- Attached in seconds
- Extends view by up to 7 inches

**72787** Clip-on towing mirror



## BLIND SPOT MIRRORS

- Reduce dangerous blind spots
- Wide Angle Convex Mirrors
- Easy installation
- Adhesive back

**7043300** 1-1/2" x 2-1/4" Rectangle

**7043400** 3-1/4" x 3-1/4" Rectangle

**7043500** 2-1/8" x 2-1/8" Square

**7043600** 2" Round, , Adjustable

**7043700** 3" Round, Adjustable, 2-Pack

**7043800** 3-3/4" Round, Adjustable

**7044000** 2" Round

**7044100** 2" Round Tinted

**7044200** 2" Round, 2-Pack

**7044300** 3" Round, 2-Pack



7044000



7043400

7043600

7044100

7043700

7043500

7043300

## TOWING ACCESSORIES



### SOLOHITCH™ ALIGNMENT SYSTEM

- Convenient one person hitch alignment system
- Magnetic base for fast easy location
- Rods adjust up to 42"
- Align trailer and hitch on first attempt

**7012900** SoloHitch™

86065



**Light Off**

**LOW** Illumination with tail lights  
**HIGH** Illumination with brake lights



86066



86061



86062

**NEW!**



86523

**NEW!**



86524

### LIGHTED HITCH COVERS

- Simple installation, Fits 1-1/4" & 2" hitches
- Long life **LED** light powered  
**LOW** illumination with tail lights  
**HIGH** illumination with brake lights
- Officially licensed and patented
- Packaged with retail TRY ME! button

**86061** GMC Lighted Hitch Cover

**86062** Chevrolet Bow Tie Lighted Hitch Cover

**86065** Ford Lighted Hitch Cover

**86066** RAM Lighted Hitch Cover

**86523** Skull Lighted Hitch Cover

**86524** USA Flag Lighted Hitch Cover

**Light Off**

**Light On**



86093



86092



86094

### LIGHTED LOGO EMBLEMS

- Long life **LED** light powered, **LOW** illumination with tail lights, **HIGH** illumination with brake lights
- Officially licensed and patented
- TRY ME! button & complete installation kit

**86091** GMC Lighted Logo Emblem

**86092** Chevrolet Lighted Logo Emblem

**86093** RAM Lighted Logo Emblem

**86094** Ford Lighted Logo Emblem

# INSTALLATION TIPS

## IMPORTANT

- Most states require a clear view of the license plate. The ball should be removed when not in use if it obstructs the view.
- Reese will not be responsible for problems occurring as the result of unauthorized modifications to Reese hitches, or the installation of hitches on vehicles other than those specified.
- If you have adjusted the bumper, exhaust system or any other vehicle components, make sure they have been retightened.
- Give the installation instructions to your customer, as they contain important consumer information. **This is required by law.**
- Reese hitches are designed to perform satisfactorily on towing vehicles in good condition. We will not be responsible for problems arising from damage, corrosion, or inadequate care of the towing vehicle.

### WARNING

Do not modify. Install only on specified vehicle in good condition. Use only for trailer towing and/or attachment of Reese accessories. Do not extend the original structure. Do not tow one trailer behind another, which may cause loss of control. Failure to heed warnings and follow instructions may result in serious personal injury or death, vehicle crash, and/or property damage. Do not overload any part of your towing system.

# PRODUCT WARRANTIES

## REESE LIMITED LIFETIME WARRANTY

This warranty applies solely to Trailer Hitches, Drawbars, Receivers, Ball Mounts, Pintle Mounts and Tow Bars manufactured by Cequent Consumer Products, Inc. and sold under the "Reese" brand (the "Product").

1. **Warranty.** Cequent Consumer Products, Inc. warrants to the original consumer purchaser ("You") that the Product will be free from defects in material or workmanship for Your lifetime as long as You own the Product. Cequent Consumer Products, Inc. makes no other warranties. If the Product does not comply with the Warranty, Cequent Consumer Products, Inc. will replace the Product without charge and within a reasonable time or, at Cequent Consumer Products, Inc. option, otherwise refund the purchase price.
2. **Limitations on the Warranty.** The Warranty does not cover the following: (a) normal wear and tear; (b) service or labor charges incurred in removing or replacing any Product; (c) the finish on a Product; (d) a Product that has been damaged through abuse, neglect, misuse or as a result of any accident or in any other manner; (e) a Product which is misapplied, overloaded, or improperly installed; and (f) a Product altered in any manner by anyone other than Cequent Consumer Products, Inc.
3. **Obligations of Purchaser.** To obtain the benefits of the Warranty, You must promptly present the defective Product and proof of purchase to Cequent Consumer Products Inc., 29000-2 Aurora Road, Solon, Ohio 44139, or any of its branches, factories, or authorized dealers listed in local directories. Any returned Product that is replaced or refunded becomes the property of Cequent Consumer Products, Inc.
4. **Legal Rights.** This Warranty gives You specific legal rights, and You also may have other rights which vary from state to state. ANY IMPLIED WARRANTY OF MERCHANTABILITY OR FITNESS FOR A PARTICULAR PURPOSE ON ANY PRODUCT SHALL BE LIMITED TO ONE YEAR FROM THE DATE OF RETAIL PURCHASE BY YOU. Some states do not allow limitations on how long an implied warranty lasts, so the above limitation may not apply to You.
5. **Remedy Limits.** Replacement of the Product or refund in the manner provided above is Your exclusive remedy and shall constitute fulfillment of all liabilities of Cequent Consumer Products, Inc. to You whether based on contract or otherwise. Cequent Consumer Products, Inc. shall not be liable or assume responsibility for the loss of the use of any vehicle, loss of time, rental of vehicles, loss or damage to personal property, expenses such as gasoline, telephone, lodging, or towing, or any other incidental or consequential damages incurred as a result of the use or ownership of any Product. Some states do not allow the exclusion or limitation of incidental or consequential damages, so the above limitation or exclusion may not apply to You. Any of the above remedy limitations shall be inoperative to the extent they are not permitted by applicable state law.

## REESE LIMITED ONE-YEAR WARRANTY

This warranty applies solely to hitch accessories and vehicle accessories manufactured by Cequent Consumer Products, Inc. and sold under the "Reese Towpower" brand which are not specifically covered by other Cequent Consumer Products, Inc. warranties (the "Product").

1. **Warranty and Warranty Period.** Cequent Consumer Products, Inc. warrants to the original consumer purchaser ("You") that the Product will be free from defects in material or workmanship for one year from the date of Your retail purchase (the "Warranty"). Cequent Consumer Products Inc. makes no other warranties. If the Product does not comply with the Warranty, Cequent Consumer Products, Inc. will replace the Product without charge and within a reasonable time or, at Cequent Consumer Products, Inc. option, otherwise refund the purchase price.
2. **Limitations on the Warranty.** The Warranty does not cover the following: (a) normal wear and tear; (b) service or labor charges incurred in removing or replacing any Product; (c) the finish on a Product; (d) a Product that has been damaged through abuse, neglect, misuse or as a result of any accident or in any other manner; (e) a Product which is misapplied, overloaded, or improperly installed; and (f) a Product altered in any manner by anyone other than Cequent Consumer Products, Inc.
3. **Obligations of Purchaser.** To obtain the benefits of the Warranty, You must present the defective Product and proof of purchase to Cequent Consumer Products, Inc., 29000-2 Aurora Road, Solon, OH 44139 or any of its branches, factories, or authorized dealers listed in local directories within 13 months from the date of your retail purchase. Any returned Product that is replaced or refunded becomes the property of Cequent Consumer Products, Inc.
4. **Legal Rights.** This Warranty gives You specific legal rights, and You also may have other rights which vary from state to state. ANY IMPLIED WARRANTY OF MERCHANTABILITY OR FITNESS FOR A PARTICULAR PURPOSE ON ANY PRODUCT SHALL BE LIMITED TO ONE YEAR FROM THE DATE OF RETAIL PURCHASE BY YOU. Some states do not allow limitations on how long an implied warranty lasts, so the above limitation may not apply to You.
5. **Remedy Limits.** Replacement of the Product or refund in the manner provided above is Your exclusive remedy and shall constitute fulfillment of all liabilities of Cequent Consumer Products, Inc. to You whether based on contract or otherwise. Cequent Consumer Products, Inc. shall not be liable or assume responsibility for the loss of the use of any vehicle, loss of time, rental of vehicles, loss or damage to personal property, expenses such as gasoline, telephone, lodging, or towing, or any other incidental or consequential damages incurred as a result of the use or ownership of any Product. Some states do not allow the exclusion or limitation of incidental or consequential damages, so the above limitation or exclusion may not apply to You. Any of the above remedy limitations shall be inoperative to the extent they are not permitted by applicable state law.

## WARRANTY DISCLAIMER FOR OTHER PRODUCTS

Cequent Consumer Products, Inc. gives no warranty for products not covered by Reese's Limited Warranty or Limited Lifetime Warranty. CEQUENT CONSUMER PRODUCTS, INC. HEREBY DISCLAIMS ALL WARRANTIES, EXPRESS OR IMPLIED, INCLUDING BUT NOT LIMITED TO ANY IMPLIED WARRANTY OF MERCHANTABILITY OR FITNESS FOR A PARTICULAR PURPOSE.

# STEPS TO SAFE, TROUBLE-FREE TOWING

**1** Identify the towing capacity of the tow vehicle.  
(See vehicle owner's manual)



**2** Determine the gross trailer & tongue weight of the tow item.  
(Fully loaded weight)



**3** Select the class of hitch, hitch ball and ball mount rated for your vehicle.



**IMPORTANT:** Never tow a trailer heavier than the rated tow capacity of your vehicle. A higher "Class" of hitch does **NOT** increase the vehicle's towing capacity.

## HITCH CLASS RATING SELECTION GUIDE

	COMPACT CARS	MID-SIZE CARS	FULL-SIZE CARS, MINI-VANS & TRUCKS	FULL-SIZE VANS TRUCKS & SUVs
<p><b>CLASS I</b> LIGHT DUTY</p> <p>WC GTW - Up to 2,000 lb WC TW - Up to 200 lb</p>				
<p><b>CLASS II</b> MEDIUM DUTY</p> <p>WC GTW - Up to 3,500 lb WC TW - Up to 350 lb</p>				
<p><b>CLASS III</b> HEAVY DUTY</p> <p>WC GTW - Up to 5,000 lb WC TW - Up to 500 lb</p>				
<p><b>CLASS IV</b> HEAVY DUTY</p> <p>WC GTW - Up to 7,000 lb    WC TW - Up to 750 lb WD GTW - Up to 12,000 lb    WD TW - Up to 1,200 lb</p>				
<p><b>CLASS V</b> EXTRA HEAVY DUTY</p> <p>WC GTW - Up to 12,000 lb    WC TW - Up to 1,250 lb WD GTW - Up to 14,000 lb    WD TW - Up to 1,400 lb</p>				

**GTW** = Gross Trailer Wt ... Weight of the trailer fully loaded  
**TW** = Tongue Weight ... Weight exerted by the trailer coupler on the hitch ball  
**WC** = Weight Carrying ... Tow rating capacity of a hitch without a WD system  
**WD** = Weight Distributing ... Tow rating capacity of a hitch when using a WD system

## ONE WRENCH TIGHTENING SYSTEM



**One Wrench Tightening System!**

- InterLock Balls and Ball Mounts provide a "One Wrench Tightening System" when used together.
- Standard Hitch Balls and Ball Mounts may also be used with InterLock products but require two wrenches for installation.
- U.S. Patent 7,661,694



### Align The Hex Shapes ... One Wrench Tightens



1 Insert the InterLock Ball Mount into the Hitch Receiver opening and secure with a Hitch Pin



2 Place the Hitch Ball shank through the hole of the Ball Mount. Align the hex shape of the Hitch Ball platform so that it fits into the hex recess of the Ball Mount



3 Using a Reese Towpower Hitch Ball Wrench, tighten the InterLock Hitch Ball nut to specifications (See Hitch Ball Package)

## SELECTING THE PROPER HITCH BALL IS A "MUST" FOR SAFE, TROUBLE-FREE TOWING

Match the Hitch Ball diameter to the Coupler size



Match the Hitch Ball shank diameter to Ball Mount hole size

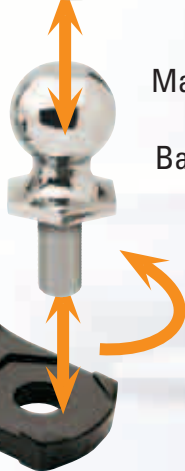

- Your towing system's maximum weight rating is always equal to the **lowest** rated component in the system
- Your hitching system cannot be upgraded to a rating higher than the maximum rating of your hitch

### For example:

A 3500 lb ball on a 2000 lb max trailer weight rated hitch does **not increase** your towing capacity to 3500 lb. Your hitching system is still rated at 2000 lb.

Conversely, a 2000 lb ball on a 3500 lb max trailer weight rated hitch **decreases** your maximum towing capacity to 2000 lb.

**Always use the properly rated hitch ball for your towing system.**



# MEASURING FOR THE PROPER BALL MOUNTS



## TRAILER NOT LEVEL

Sometimes a trailers tongue is higher or lower than the ball mount on the vehicle, and a ball mount with a "rise" or a "drop" is required to level the trailer.

## TOW VEHICLE & TRAILER LEVEL

For safe, comfortable towing, the trailer should always be set up to tow on a level plane.

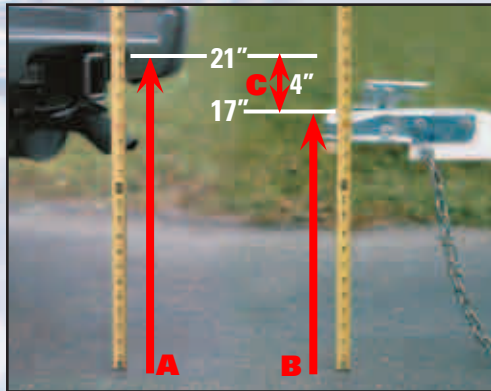

**A** Measure from the ground to the top of the hitch

**B** Measure from the ground to the (inside) top of the trailer coupler, when level

**C** Determine the "DROP" or "RISE"

DROP: If the coupler is LOWER than the hitch: ADD the height of the hitch ball (usually 2.5"-3")

RISE: If the coupler is HIGHER than the hitch: SUBTRACT the height of the hitch ball (usually 2.5"-3")

A 7" DROP is needed to make this trailer level  
 $4" (\text{Hitch} - \text{Coupler}) + 3" (\text{Hitch Ball Ht.}) = 7" (\text{DROP})$

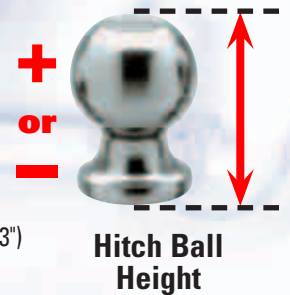

## BALL MOUNT MEASUREMENTS



### LENGTH

Distance from the center of the ball hole to the center of the pin hole

### DROP

Distance from the top of the shank to the top of the ball platform



### RISE

Distance from the top of the ball platform to the top of the shank

## MERCHANDISING

### HITCH BALL RACK - 7008800

- Holds up to 39 Open Style Hitch Balls
- Self-Facing Design for Great Presentation
- Quality, Strong Construction
- 1-1/4" Channel for Signing and Pricing



### BALL MOUNT RACK - 1350700

- Holds up to 32 Ball Mounts
- Quality, Strong Construction
- 1-1/4" Channel for Signing and Pricing



### COMBO RACK - 7008900

- Holds up to 21 Hitch Balls & 18 Ball Mounts
- Quality, Strong Construction
- 1-1/4" Channel for Signing and Pricing



Part No.	Description
<b>7008800</b>	Hitch Ball Rack
<b>1350700</b>	Ball Mount Rack
<b>7008900</b>	Combo Rack: Hitch Balls & Ball Mounts
<b>7046500</b>	Jack Rack Crossbar
<b>7046600</b>	Jack Rack Foot Mount 2 pack
<b>7046700</b>	Jack Rack A-Frame Mount

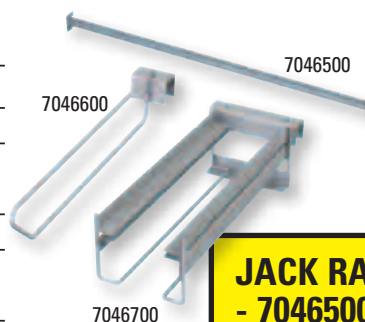

### JACK RACK SYSTEM - 7046500, 7046600, 7046700

- Quality, Strong Construction



To order any of the Merchandising Racks shown here,  
call Customer Service **1-800-234-6992**

Part No.	Description	Page #	Part No.	Description	Page #
028244	Tongue Mount Coupler .....	56	21790	InterLock® Ball Mount .....	21
028287	A-Frame Tongue Mount Coupler .....	57	21791	InterLock® Ball Mount .....	21
028288	A-Frame Tongue Mount Coupler .....	57	21792	InterLock® Ball Mount .....	20
028351	Gooseneck Coupler Ball .....	55	21793	InterLock® Ball Mount .....	20
028352	Gooseneck Coupler Ball .....	55	21794	InterLock® Ball Mount .....	20
028375	Gooseneck Coupler Ball .....	55	21900	InterLock® Ball Mount .....	20
028381	Tongue Mount Coupler .....	56	21901	InterLock® Ball Mount .....	20
028382	Tongue Mount Coupler .....	56	30035	Fifth Wheel Rails .....	18
028383	Tongue Mount Coupler .....	56	30056	Fifth Wheel Hitch .....	18
028384	A-Frame Tongue Mount Coupler .....	57	33 SERIES	Class III Custom-Fit Hitch.....	14
028386	A-Frame Tongue Mount Coupler .....	57	33305 1360	Coupler .....	47
028390	Channel Mount Coupler .....	56	35 SERIES	Class III Custom-Fit Hitch.....	14
028400	Gooseneck Coupler Ball .....	55	36 SERIES	Class III Custom-Fit Hitch.....	14
028462	Tongue Mount Coupler .....	56	37 SERIES	Class IV Custom-Fit Hitch .....	15
028463	A-Frame Tongue Mount Coupler .....	57	37041	Class III Multi-Fit Receiver Hitch .....	8
028630	Channel Mount Coupler .....	56	37042	Class III Multi-Fit Receiver Hitch .....	9
0287640300	Adjust. Gooseneck Coupler. ....	55	37094	Class IV Multi-Fit Receiver Hitch .....	9
0289340317	Adjust. Gooseneck Coupler .....	55	37096	Class III Multi-Fit Receiver Hitch .....	9
033100	5/8" diameter pin and clip for 2-1/2" receiver hitch .....	38	41 SERIES	Class V Custom-Fit Hitch .....	16
06 SERIES	Class II Custom-Fit Insta-Hitch .....	13	44 SERIES	Class IV Custom-Fit Hitch .....	15
06280	Zinc Ball Mount .....	22	44305R1360	Coupler .....	47
06474	Zinc Ball Mount .....	22	45 SERIES	Class V Custom-Fit Hitch .....	16
11003	Hitch Box Extension.....	66	49802	Fold Down Licence Plate Holder .....	17
11004	Hitch Box Extension.....	66	49901	Weight distributing system .....	31
11006	Hitch Box Extension.....	66	49902	Weight distributing system .....	31
11021	Receiver Tube with Collar.....	66	49903	Weight distributing system .....	31
11080	Receiver Tube with Collar.....	66	500105	Sidewind crank for 170 series .....	53
151401	2000 lb Topwind round jack .....	52	500171	Sidewind crank for 190 series .....	53
155022	2000 lb Topwind A-frame jack .....	52	500180	Top crank .....	53
155032	5000 lb Topwind A-frame jack .....	52	500244	2" Removable foot plate .....	53
158109	2000 lb Sidewind round swivel jack .....	53	500244	Detachable disc foot .....	62
158151	2000 lb Sidewind round tube mount jack .....	53	500245	Removable caster w/ polywheel .....	53
158451	2000 lb Topwind round swivel jack .....	52	51 SERIES	Class I Custom-Fit Insta-Hitch .....	12
158452	2000 lb Topwind round swivel jack .....	52	51 SERIES	Class II Custom-Fit Insta-Hitch .....	13
158486	2000 lb Round tube topwind jack .....	52	51 SERIES	Class III-IV Custom-Fit Hitch.....	15
178151	5000 lb Round tube topwind jack .....	52	5443	Licence Plate Adapter .....	17
178203	5000 lb Round tube sidewind jack. ....	53	54970	Adjustable hitch bar .....	31
182800NH	12000 lb Square tube jack. ....	54	6495	Winch Mounting Plate .....	17
190704	8000 lb Square tube direct weld jack .....	54	6715	Spare Tire Carrier.....	17
190754	8000 lb Square tube direct weld jack .....	54	6758	Work Step .....	17
21141	Adjustable Ball Mount .....	28	6771	Receiver Tube Skid Shield.....	17
21171	Ball Mount .....	23	6980	Handle Kit for 6495 Winch Mounting Plate.....	17
21175	Ball Mount .....	23	58109	Hitch Ball Bushing .....	63
21186	Ball Mount .....	23	7000100	Wheel chock 2 piece set .....	62
21287	Chrome Ball Mount.....	22	7000300	Heavy duty mountable dock chock .....	62
21288	Chrome Ball Mount.....	22	7000400	Stainless steel Bent Pin Receiver lock .....	39
21289	Chrome Ball Mount.....	22	7000600	Rubber receiver plug for 2" .....	63
21330	Forged Ball Mount .....	28	7001100	Easy Access coupler lock .....	43
21331	Forged Ball Mount .....	28	7004700	Dual-Fit Fas-Lok™ Coupler .....	47
21332	Forged Ball Mount .....	28	7004800	Dual-Fit Fas-Lok™ Coupler .....	47
21344	Ball Mount .....	23	7004900	Dual-Fit KeyLok™ Coupler .....	47
21345	Ball Mount .....	23	7005000	Dual-Fit KeyLok™ Coupler .....	47
21347	Ball Mount .....	23	7005100	InterLock® Towing Security Kit .....	26
21511	Dual Ball Mount.....	28	7005200	InterLock® Towing Security Kit .....	26
21512	Triple Ball Mount.....	29	7005300	Adjustable brass coupler lock .....	42
21514	Triple Ball Mount.....	29	7005600	Sleeved barrel chrome receiver lock .....	41
21518	Dual Ball Mount.....	28	7005800	Adjustable stainless steel coupler lock .....	41
21536	Towing Starter Kit .....	27	7005900	Stainless steel sleeved barrel and coupler lock ...	41, 42
21542	InterLock® Towing Starter Kit.....	27	7006000	Bent Pin Receiver lock .....	39
21543	InterLock® Towing Starter Kit.....	27	7006100	Dual, bent pin lock (5/8" & 1/2") & brass coupler lock .....	39
21554	InterLock® Towing Security Kit.....	26	7006400	Ball Mount Lock .....	39
21556	Towing Starter Kit .....	27	7006500	Ball Mount Lock .....	39
			7006600	Trailer coupler lock .....	42
			7006700	Anti-Theft Receiver Pin .....	38

<b>Part No.</b>	<b>Description</b>	<b>Page #</b>	<b>Part No.</b>	<b>Description</b>	<b>Page #</b>
7006800	Sleeved Receiver Pin & Clip .....	38	7028400	Class V Chrome Hitch Ball .....	32
7007100	Anti-Theft Receiver Pin .....	38	7028500	Class V Chrome Hitch Ball .....	32
7007200	Anti-Theft Receiver Pin .....	38	7028600	Class V Chrome Hitch Ball .....	32
7007300	Anti-Theft Receiver Pin .....	38	7028700	2-1/2" to 2" Adapter .....	32
7007400	Black tow hook .....	66	7029600	2 Pack - Single dose hitch ball lubricant .....	25, 64
7007500	Towing safety cables .....	64	7030200	5/8" diameter Stainless Steel Pro Receiver Lock .....	37
7007600	Safety chain, 1" Quick Link and 1 U-Bolt .....	66	7030300	5/8" diameter Professional Receiver Lock .....	37
7007700	Safety chain and 2" S - Hooks .....	66	7030400	5/8" diameter Bent Pin Professional Receiver Lock ..	37
7007800	Safety chain and 2" Quick Links .....	66	7030500	Professional Coupler Lock .....	37
7007900	Quick Links .....	66	7030600	5/8" diameter Professional Receiver Lock and Coupler Lock .....	37
7008000	Quick Links .....	66	7031300	Adjustable Ball Mount .....	28
7008100	Chrome InterLock® Hitch Ball .....	24	7031400	Tri-Ball Mount with Hook .....	33
7008200	Chrome InterLock® Hitch Ball .....	24	7031500	Easy Access Adjustable coupler lock .....	43
7008300	Chrome InterLock® Hitch Ball .....	24	7031600	Easy Access Sleeved Receiver Lock and Cable .....	45
7008400	Chrome InterLock® Hitch Ball .....	24	7031700	Clevis pin .....	33
7008500	Chrome InterLock® Hitch Ball .....	24	7032100	SureLock™ Retractable Cable Security System .....	46
7008600	Chrome InterLock® Hitch Ball .....	24	7033100	Class V zinc finish receiver pin and clip .....	41
7008700	Chrome InterLock® Hitch Ball .....	24	7033200	Class V bent pin chrome receiver lock .....	41
7009100	1/2" diameter pin and clip with black comfort grip ...	38	7033300	Class V barrel chrome receiver .....	41
7009200	5/8" diameter pin and clip with black comfort grip ...	38	7033400	48" Farm Jack .....	59
7009300	1/2" & 5/8" Sleeved easy access lock .....	43	7033500	SureLock™ Cable Security System and Tool Box Mounting Grommet .....	46
7010100	Stainless steel sleeved barrel receiver lock .....	41	7033600	2000 lb Portable Electric Winch .....	51
7010200	Sleeved barrel receiver lock & coupler lock .....	41, 42	7033830	Spare Tire Security - Cable and Lock .....	45
7010500	5/8" diameter pin and clip .....	38	7033930	Class V Chrome Hitch Ball .....	32
7010600	1/2" diameter pin and clip .....	38	7034030	Cable with Integrated 90° Lock .....	45
7011300	Stainless Steel InterLock® Hitch Ball .....	24	7034100	2 Ton Steel Cable Puller .....	65
7011400	Stainless Steel InterLock® Hitch Ball .....	24	7034200	Dual View clip-on towing mirror .....	67
7012900	SoloHitch™ .....	68	7034300	InterLock® Ball Mount .....	21
7013100	Ball cover 1-7/8" and 2" .....	63	7034400	InterLock® Ball Mount .....	21
7013700	Lunette Ring .....	30	7036400	Powered A-frame jack .....	59
7014200	Adjustable tow bar .....	65	7036700	Wheel Bearing Protector Set .....	64
7014500	Anti-Theft Receiver Pin with Lock .....	38	7036800	ATV/Lawn Tractor Hitch Ball .....	25
7014700	Tow and Store Lock Kit .....	42	7036930	Locking Cable .....	44
7016800	Single Speed Trailer Winch .....	49	7037030	Locking Cable .....	44
7019200	Marine spare tire carrier w/ locking levers and lock ...	43	7037130	Locking Cable .....	44
7020500	Receiver Adapter .....	23	7037230	Locking Cable .....	44
7021200	Anti-Theft Receiver Pin with Lock .....	38	7037430	Locking Cable .....	44
7021300	3 pack comfort grip clips .....	38	7037530	Locking Cable .....	44
7021500	Pintle Replacement Ball .....	30	7037630	Locking Cable .....	44
7021600	Pintle Replacement Ball .....	30	7037700	U-Lock .....	45
7021700	Pintle Replacement Ball .....	30	7037930	Locking Cable .....	44
7021800	Rotating Adjustable Tri-Ball .....	29	7038000	U-Lock & Cable .....	45
7022400	Triple Ball Mount .....	29	7038130	Locking Cable .....	44
7022700	Wheel chock 2 piece set .....	62	7038230	Locking Cable .....	44
7022800	Receiver mount clevis and ball mount combo .....	33	7038300	U-Lock .....	45
7022900	Receiver Adapter .....	23	7038700	U-Lock .....	45
7023100	Chrome collar and rubber receiver plug for 2" .....	63	7038800	U-Lock .....	45
7023500	Anti-rattle hitch pin™ .....	43	7039000	ELITE Black Nickel sleeved barrel receiver lock .....	40
7023900	2-Pack Security Lock Set .....	39	7039100	ELITE Sure Grip cushion grip barrel receiver lock ...	40
7024000	1-7/8" ball and pintle combo .....	31	7039200	Elite Ball & Ball Mount .....	26
7024100	2" ball and pintle combo .....	31	7039800	Triple Ball Mount .....	29
7024200	2-5/16" ball & pintle combo .....	31	7042100	Adjustable brushed silver coupler lock .....	42
7024300	5 ton pintle hook .....	31	7042900	Dual Wheel Swing Away Jack .....	58
7024400	Forged receiver mount tow hook .....	31	7043000	InterLock® Towing Starter Kit .....	27
7024500	Forged receiver mount tow eye .....	31	7043100	InterLock® Towing Starter Kit .....	27
7024600	Receiver mount tow ring .....	31	7043200	Towing Starter Kit .....	27
7024800	Tow bar chains .....	65	7043300	Blind Spot Mirror .....	67
7025700	Safety chain and 2" Quick Links .....	66	7043400	Blind Spot Mirror .....	67
7027800	3/4" Nut and washer for hitch ball .....	24	7043500	Blind Spot Mirror .....	67
7027900	1" Nut and washer for hitch ball .....	24	7043600	Blind Spot Mirror .....	67
7028000	1-1/4" Nut and washer for hitch ball .....	24	7043700	Blind Spot Mirror .....	67
7028100	Class V Ball Mount .....	32	7043800	Blind Spot Mirror .....	67
7028200	Class V Ball Mount .....	32	7044000	Blind Spot Mirror .....	67
7028300	Class V Ball Mount .....	32			

Part No.	Description	Page #	Part No.	Description	Page #
7044100	Blind Spot Mirror .....	67	74308	Interchangeable Hitch Ball System .....	25
7044200	Blind Spot Mirror .....	67	74309	Interchangeable Hitch Ball System .....	25
7044300	Blind Spot Mirror .....	67	74317	Wheel Bearing Kit with Dust Cover .....	64
7044900	Coupler Pin and Chain .....	47	74326	Caster Wheel .....	62
7044900	Pintle pin and chain .....	30	74329	Single Speed Trailer Winch .....	48
7048400	Farm Jack Foot Plate .....	59	74336	20 Ft. Winch Strap and Hook .....	48
7051000	Excalibur Steering Wheel lock .....	35	74337	Single Speed Trailer Winch .....	48
7051100	Barricade Steering Wheel lock .....	34	74338	Fas-Lok™ Coupler .....	47
7051200	On Guard Steering Wheel lock .....	35	74342	Hitch ball wrench .....	63
7051500	Rubber receiver plug for 1-1/4" .....	63	74344	Adjustable tow bar .....	65
7051900	Ball Mount with Hook .....	33	74407	Top wind A-frame jack .....	58
7052500	Receiver Adapter .....	23	74410	Snap-ring swivel mount side wind jack .....	58
7054700	TransRACK Cargo Truck Rack System .....	61	74412	Side mount top wind jack .....	58
7054900	TransRACK Conduit carrier .....	61	74413	Side mount top wind jack .....	58
7055000	TransRACK Trimmer Rack .....	61	74414	2000 lb Industrial topwind jack .....	52
7055100	TransRACK Tool Rack .....	61	74415	2000 lb Industrial topwind jack .....	52
7055200	TransRACK Top rail kit .....	61	74418	Single Speed Trailer Winch .....	48
7057700	Heavy duty pin and clip .....	38	74419	Single Speed Trailer Winch .....	48
72783	Universal coupler lock .....	42	74514	Tethered rubber hitch receiver cover with 4-way flat holder .....	63
72786	Safety chain and 1" Quick Link and 1 U-Bolt) .....	66	74529	Two Speed Trailer Winch .....	51
72787	Clip-on towing mirror .....	67	74547	Replacement receiver plug for 2" .....	63
72789	Wheel Bearing Kit .....	64	74556	Single Speed Trailer Winch .....	48
72790	Wheel Bearing Kit .....	64	74557	Snap-ring swivel mount side wind jack .....	58
72791	Wheel Bearing Kit .....	64	74783	Fas-Lok™ Coupler .....	47
72800	InterLock® Hitch Ball Bushing .....	63	74796	Coupler repair kit .....	47
72801	Chrome InterLock® Hitch Ball .....	24	74797	Coupler repair kit .....	47
72802	Chrome InterLock® Hitch Ball .....	24	77 SERIES	Class I Custom-Fit Insta-Hitch .....	12
72803	Chrome InterLock® Hitch Ball .....	24	81378	Step bumper receiver hitch .....	64
72804	Chrome InterLock® Hitch Ball .....	24	8339	Gooseneck Hitch .....	18
72805	Chrome InterLock® Hitch Ball .....	24	86061	GMC Lighted Hitch Cover .....	68
72806	Chrome InterLock® Hitch Ball .....	24	86062	Chevrolet Bow Tie Lighted Hitch Cover .....	68
72807	Chrome InterLock® Hitch Ball .....	24	86065	Ford Lighted Hitch Cover .....	68
72843	Stainless Steel InterLock® Hitch Ball .....	24	86066	RAM Lighted Hitch Cover .....	68
72844	Stainless Steel InterLock® Hitch Ball .....	24	86091	GMC Lighted Logo Emblem .....	68
74005	Zinc Hitch Ball .....	25	86092	Chevrolet Lighted Logo Emblem .....	68
74006	Chrome Hitch Ball .....	25	86093	RAM Lighted Logo Emblem .....	68
74007	Zinc Hitch Ball .....	25	86094	Ford Lighted Logo Emblem .....	68
74008	Chrome Hitch Ball .....	25	86523	Skull Lighted Hitch Cover .....	68
74009	Zinc Hitch Ball .....	25	86524	USA Flag Lighted Hitch Cover .....	68
74010	Chrome Hitch Ball .....	25	88001	Class II MUlti-Fit Receiver Hitch .....	8
74011	Zinc Hitch Ball .....	25	88002	Class II MUlti-Fit Receiver Hitch .....	8
74013	Chrome Hitch Ball .....	25	8040900	Receiver mount clevis .....	33
74020	Chrome Hitch Ball .....	25	FW20000101	Single Speed Trailer Winch .....	49
74021	Chrome Hitch Ball .....	25	T1100Z0101	Single Speed Trailer Winch .....	49
74022	Chrome Hitch Ball .....	25	T1300 0101	Single Speed Trailer Winch .....	49
74023	Chrome Hitch Ball .....	25	T1500z0101	Single Speed Trailer Winch .....	49
74024	Chrome Hitch Ball .....	25	T1602 0101	Single Speed Trailer Winch .....	49
74025	Chrome Hitch Ball .....	25	T1801 0101	Single Speed Trailer Winch .....	49
74026	Chrome Hitch Ball .....	25	T1801Z0101	Single Speed Trailer Winch .....	49
74040	Fas-Lok™ Coupler .....	47	T2005 0101	Two Speed Trailer Winch .....	50
74042	Fas-Lok™ Coupler .....	47	T2005Z0101	Two Speed Trailer Winch .....	50
74059	Safety chain and 2" Quick Links .....	66	T2605 0101	Two Speed Trailer Winch .....	50
74099	Black nylon Receiver Tube Cover for 2" .....	63	T3205 0101	Two Speed Trailer Winch .....	50
74115	8 Ton Pintle Ball & Hook Combo .....	30	TL005	SureLok™ Receiver Hitch Mounting Kit .....	46
74116	8 Ton Pintle Ball & Hook Combo .....	30	TL006	SureLok™ Truck Stake Hitch Mounting Kit .....	46
74117	8 Ton Pintle Ball & Hook Combo .....	30	TL007	SureLok™ Trailer U-Bolt Mounting Kit .....	46
74118	Pintle Hook .....	30	TL008	SureLok™ RV Bumper Mounting Kit .....	46
74119	Pintle Hook .....	30	TL009	SureLok™ ATV/UTV Mounting Kit .....	46
74176	Wheel Bearing Protector Set .....	64	TL010	SureLok™ Tool Box Mounting Kit .....	46
74177	Wheel Bearing Protector Set .....	64	XLT14ZB101	Single Speed Trailer Winch .....	49
74247	Economy spare tire carrier .....	43			
74280	Fas-Lok™ Coupler .....	47			
74281	Pintle hook mounting plate .....	30			
74307	Interchangeable Hitch Ball System .....	25			



# Legendary Towing

*to the Track and Back!*



For more than 55 years REESE, the #1 name in towing, has been getting you to the track and back with quality towing products.

REESE towing leadership is built on innovation, American engineering and the highest product standards in the industry.



**Reese Towpower®, the Most Trusted Towing Name on and off the Track.**

[CequentConsumerProducts.com](http://CequentConsumerProducts.com)



[ReeseTowpower.com](http://ReeseTowpower.com)  
[#ReeseTowpower](https://twitter.com/ReeseTowpower)