



**rdi**

For home, for life.®

[www.rdirail.com](http://www.rdirail.com)

# 2019

## Product Guide





# Who We Are

## **WE TAKE YOUR SAFETY SERIOUSLY**

We design our products for optimum form and function. Sure, our railing looks nice, but it is also a safety product, and we take protecting you very seriously. Our products are designed to meet or exceed the highest safety standards. Code test documents can be viewed on our website at [www.rdirail.com/code](http://www.rdirail.com/code).

## **TOP IN CUSTOMER SERVICE**

We exist because of you, our Customer, and for that reason we have always made Customer Service our top priority. We are proud to say that our Customers tell us that we are ranked at the top in Customer Service.

## **LEADING INNOVATOR**

We are the leading innovator in the porch and railing product category with over 20 patents.

## **WE MAKE IT SIMPLE**

The founders of the RDI brand were carpenters who knew the importance of keeping products “simple stupid”. Whether you’re a skilled craftsman or a “weekend warrior”, our products are simple, and our top-quality instructions complete with illustrations come in every box.





**4**  
HideAway®  
Privacy Rail

**12**  
mix'n'match

**14**  
Transform®

**24**  
Avalon®  
Aluminum Railing

**34**  
Metal Works®  
Excalibur®

**42**  
Endurance®  
Original Rail

**50**  
Finyl Line™

**60**  
Titan Pro Rail®

**68**  
Vinyl ADA  
Hand Rail

**72**  
Aluminum ADA  
Hand Rail

**76**  
Crossover  
Product

**88**  
Outdoor  
Accents

# PRIVACY SOLUTIONS

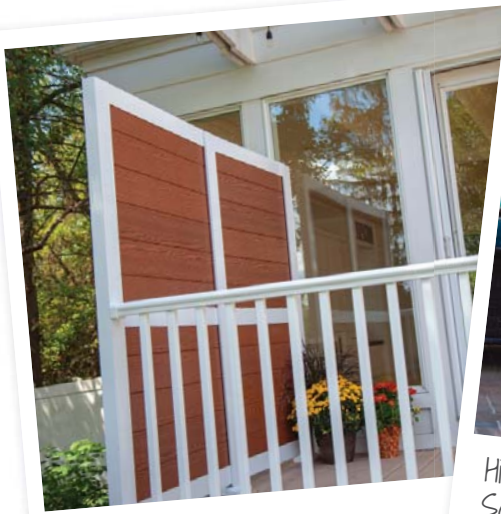

HideAway Privacy Rail in White + Redwood with Titan Pro Rail

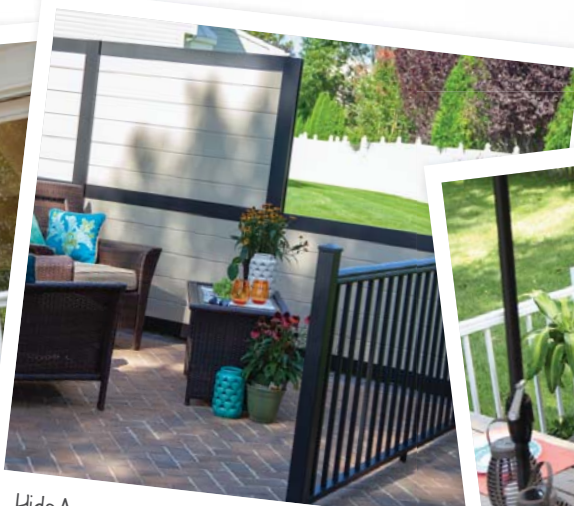

HideAway Privacy Rail (2 full, 1 half) in Satin Black + Earth with Avalon



HideAway Privacy Rail (2 full, 1 half) in White + Birchwood with Avalon in White

**HideAway™ Privacy Railing** provides a code compliant solution for privacy on your deck or patio. Powder-coated rails are strong and durable and infill boards with patented **ClickConnect™** technology lock tightly together for complete privacy. Install at the full height of 6', or create half privacy panels at 36" or 42".

Realistic woodgrain patterns!



(See more details on pg. 6)



Black Celtic Decorative Screen Panels, hung



Saddle Morse Decorative Screen Panels in Frame Kits in a 3-2-1 configuration



White Morse Decorative Screen panels in a Frame Kit (6' tall)

**Decorative Screen Panels**, combined with our unique **Frame Kit**, allow you to create semi-privacy using 1, 2, or 3 panels in a variety of configurations. Decorative Screen Panels can also be installed under the deck for a stylish upgrade to traditional lattice or hung to provide an upscale way to create a more private space.

(See more details on pg. 88)

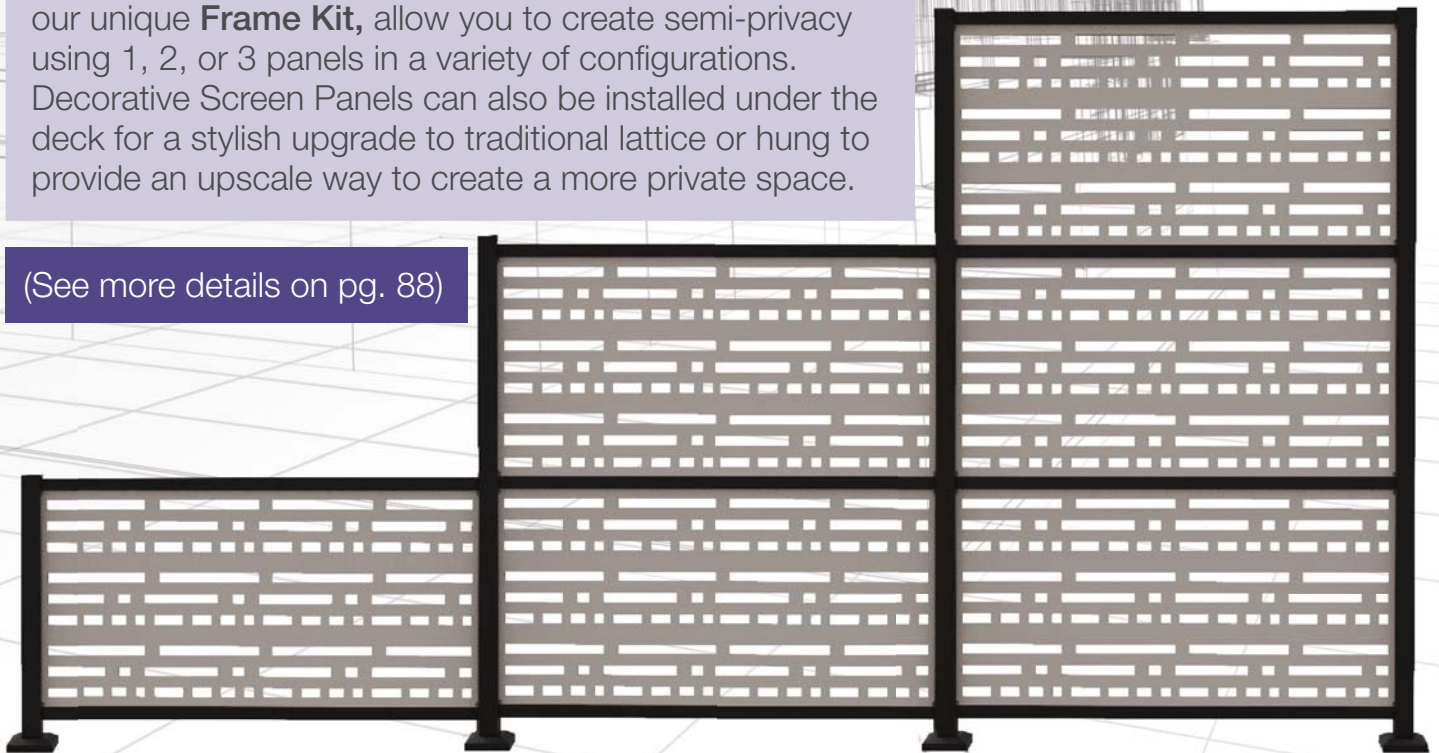

# PRIVACY RAILING



# HideAway™

PRIVACY RAILING



**HIDEAWAY PRIVACY RAIL®**, the newest member of the RDI family of products, provides a contemporary and modern look to your deck or patio while offering you the option of privacy in your outdoor space. Powder coated aluminum framing provides strength for your installation while a selection of vinyl infill boards lock securely together with our patented ClickConnect™ technology. Designed to meet IBC and IRC, HideAway allows you to create privacy that is safe, secure, and code compliant for decks of any height.



# FEATURE SPOTLIGHT



2

1

ClickConnect™



# HideAway™

## PRIVACY RAILING



1

### STRONG & SECURE

Patented **ClickConnect™** vinyl infill boards lock securely together and fit tightly in post channels. Top, mid, and bottom aluminum rails attach into posts to provide strength and support, making HideAway rail code compliant for use on decks and porches.

2

### VERSATILE POSTS

HideAway privacy panels can be installed as full 6' tall sections for complete privacy using our 72" posts, or as "half privacy" panels with a 36" or 42" finished height. Posts come as end, mid, or corner, and include pre-mounted base plates.

3

### INFILL OPTIONS

Vinyl infill boards come in 3 wood grain color options and 3 solid colors so you can create a high end custom look that also provides you privacy.

4

### EXCEPTIONAL STRENGTH

Durable powder-coated aluminum is AAMA certified and rust proof. And with 10,000 hours of salt-spray testing (used to accelerate corrosion performance of a coating system), HideAway posts & rails perform at more than 3 times the required standard of 3,000 hours!

*The HideAway Railing System exceeds U.S. building code requirements. Always consult your local Building Code Department for applicable regulations and product acceptance. For additional information on HideAway or other RDI products visit [www.rdirail.com](http://www.rdirail.com) or contact our Customer Service Department at (877) 420-7245.*

# HOW TO ORDER

## 1 SELECT YOUR RAIL KIT OPTIONS

HideAway™ privacy Rail Kits are available in full privacy or half privacy giving you the flexibility to design the perfect solution for your desired level of privacy. Kits come in Satin Black or White.



Full Privacy Panel



Half Privacy Panel

Full Privacy Rail Kits include top and bottom rails, and mid rail. Half privacy kits include top and bottom rail

## 2 CHOOSE YOUR POSTS

HideAway privacy rail offers posts in end, mid, and corner configurations in both Satin Black and White. A post is needed at each end of your HideAway rail panels. End posts can also be used to transition from privacy to our vinyl or aluminum. 42" posts can be used for half privacy sections 36" or 42", and 72" posts are used for full privacy sections.



End Post



Mid Post



Corner Post

Posts come with pre-mounted base plates, 2-piece trim rings, infill board adapters, post hardware covers, channel cover, and flat caps.

## 3 CHOOSE YOUR BOARDS

Select your infill boards (pack of 6) in 6 different colors to complete your privacy solution! Infill boards lock securely together with our ClickConnect™ technology and fit snugly into the infill adapter channels in posts.



White

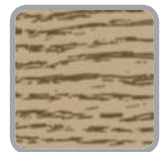

Birchwood



Earth



Redwood



Dune



Saddlewood

# SKU LIST

## 1 HIDEAWAY PRIVACY RAIL – RAIL KITS

DESCRIPTION	WHITE	SATIN BLACK
6' Full Privacy Rail Kit (Includes top rail, bottom rail, and mid rail)	<b>73042844</b>	<b>73042828</b>
6' Half Privacy Rail Kit (Includes top rail and bottom rail)	<b>73042845</b>	<b>73042827</b>

*Infill boards sold separately. Full privacy panel requires 11 infill boards, half privacy requires 5 for 36" finished height or 6 for 42" finished height. An installed section using 2 end posts measures a finished width of 6'. If advanced wind load (check local codes) requirements are necessary, then full privacy railing (6' tall) must have post spacing every 3'.*

## 2 HIDEAWAY PRIVACY RAIL – POSTS

DESCRIPTION	WHITE	SATIN BLACK
42" End Post – Surface Mount	<b>73042839</b>	<b>73042834</b>
42" Mid Post – Surface Mount	<b>73042840</b>	<b>73042832</b>
42" Corner Post – Surface Mount	<b>73042838</b>	<b>73042833</b>
72" End Post – Surface Mount	<b>73042842</b>	<b>73042837</b>
72" Mid Post – Surface Mount	<b>73042843</b>	<b>73042835</b>
72" Corner Post – Surface Mount	<b>73042841</b>	<b>73042836</b>

*42" posts are used for half privacy panels for 42" height railing, or for a finished railing height of 36" (42" post can be cut down to for 36" rail height). 72" posts are used for full privacy sections.*

INCLUDED WITH POSTS	END POST	MID POST	CORNER POST
Post with pre-mounted base plate	1	1	1
Flat post cap	1	1	1
2-piece trim ring	1	1	1
Infill adapter channels – 27"*	1	2	2
Infill adapter channels – 31 5/16"**	1	2	2
Post hardware cover	1	1	2
36" channel cover**	N/A	1	1
Hardware pack (Includes 2 vinyl shims)	1	1	1

*\*42" posts do not include 27" infill adapter channels.*

*\*\* 36" channel cover included in 72" posts only for a finished look transitioning from full to half privacy.*

## 3 HIDEAWAY PRIVACY RAIL – INFILL

DESCRIPTION	SKU
6" x 6' Vinyl Interlocking Boards – Pack of 6 – WHITE	<b>73042846</b>
6" x 6' Vinyl Interlocking Boards – Pack of 6 – EARTH	<b>73043492</b>
6" x 6' Vinyl Interlocking Boards – Pack of 6 – DUNE	<b>73043491</b>
6" x 6' Vinyl Interlocking Boards – Pack of 6 – BIRCHWOOD	<b>73042831</b>
6" x 6' Vinyl Interlocking Boards – Pack of 6 – REDWOOD	<b>73042830</b>
6" x 6' Vinyl Interlocking Boards – Pack of 6 – SADDLEWOOD	<b>73042829</b>

# CUSTOMIZE YOUR STYLE



## transform<sup>®</sup> + AVALON

- 1** Select your Transform post sleeve, post top, and trim ring options (4 color choices).  
Transform – page 20
- 2** Select your Avalon panel or glass beam kit and glass slats (3 color choices).  
Avalon – page 31
- 3** Install Avalon with the Tristan Top Rail option.  
Avalon – page 32
- 4** Select from 4 Transform top rails which install right onto the Tristan (4 color choices).  
Transform – page 22
- 5** Add ambience with Transform LED post caps, Transform side or dome lights, or under-rail lighting.  
Transform – page 23





## transform<sup>®</sup> + EXCALIBUR

- 1** Select your Transform post sleeve, post top, and trim ring options (4 color choices).  
Transform – page 20
- 2** Select your Excalibur panel (2 color choices).  
Excalibur – page 40
- 3** Install the Excalibur adaptor piece on the top of the panel.  
Transform – page 23
- 4** Select from 4 Transform top rails which install right onto the adaptor (4 color choices).  
Transform – page 22
- 5** Add ambience with Transform LED post caps, Transform side or dome lights, or under-rail lighting.  
Transform – page 23



# RESALITE® RAILING



Transform®, made from RDI's resin based, state-of-the-art Resalite® core contains no wood! Transform has the elements that you want in a wood railing – the weight, look, and feel of wood, and nothing that you don't. Transform will not absorb water so it won't rot and it resists weathering, discoloration, and sagging. Transform's 100% acrylic exterior surface provides long lasting color and a lightly textured, low-maintenance durable finish.





# FEATURE SPOTLIGHT

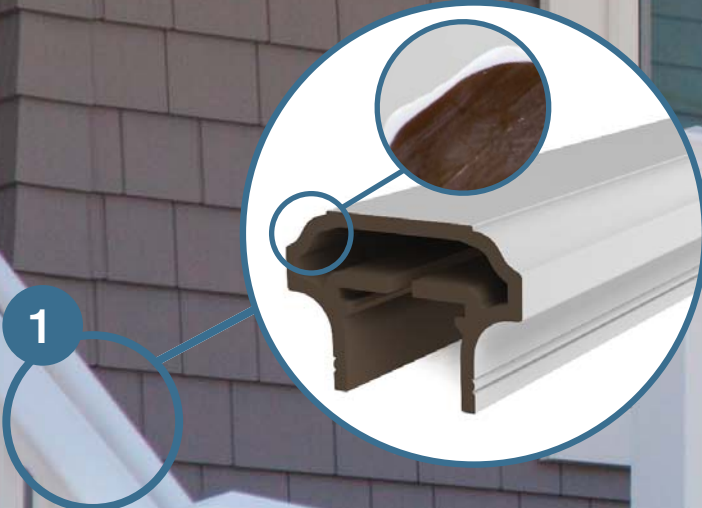

1

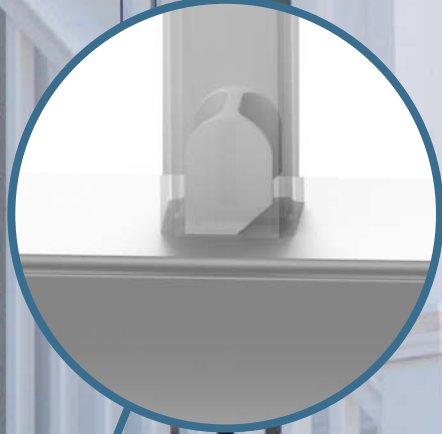

2



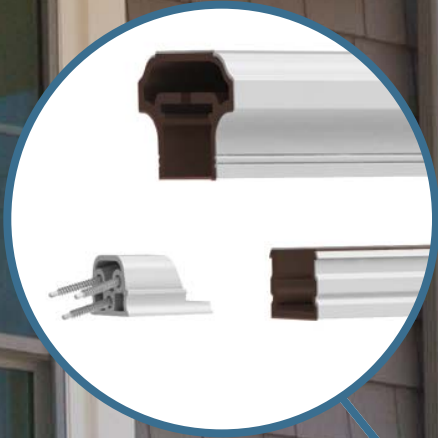

Satin White

Wheat

Caramel

Ironstone

3

1

## STATE-OF-THE-ART RESALITE® CORE WITH ACRYLIC CAP

An industry first, ultra low-maintenance acrylic surface provides a satin, wood-like appearance and superior color pigment retention, for gorgeous, lasting color and fade-resistance. Unlike Wood Plastic Composites (WPCs), Resalite contains no wood or organic fibers. Weather resistant and strong, Resalite won't absorb water or rot and resists discoloration, fading, and sagging.

2

## SIMPLE LEVEL AND STAIR BALUSTER ATTACHMENT

Transform balusters attach quickly and easily with mounting adapters, saving time by eliminating the need for tedious nailing or screwing each baluster into the railing. This innovative baluster adapter works in level and stair rail configurations.

3

## UNIQUE HIDDEN BRACKET DESIGN

Brackets are completely concealed within the rail structure, providing a clean finished look. One bracket is used for all applications: use bracket as-is for level sections or cut to desired angle for stair and angled installations.

*The Transform Railing System exceeds U.S. building code requirements. Always consult your local Building Code Department for applicable regulations and product acceptance. For additional information on Transform or other RDI products visit [www.rdirail.com](http://www.rdirail.com) or contact our Customer Service Department at (877) 420-7245.*

# HOW TO ORDER

SELECT A POST (IF YOUR INSTALLATION REQUIRES A STRUCTURAL POST)

## 1a CHOOSE A STRUCTURAL POST

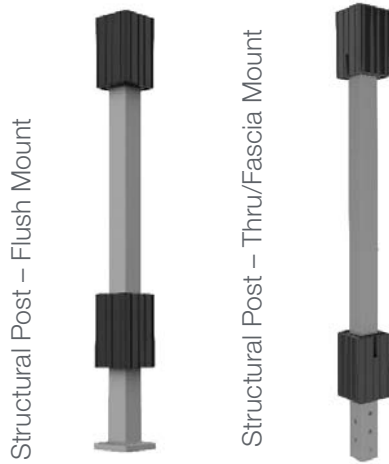

- Available for 36" and 42" heights.

## 1b CHOOSE A POST SLEEVE

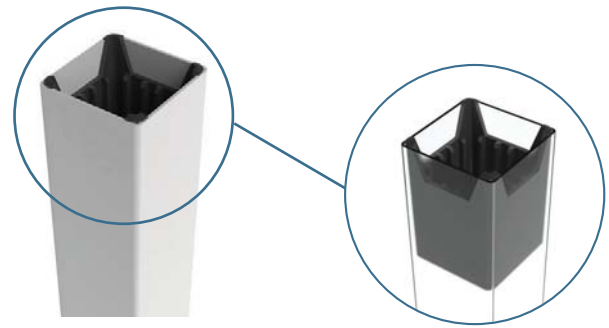

- 39", 54", and 120" lengths available.
- Each post sleeve comes with 2 post inserts; can also be purchased separately for use when cutting down 120" post sleeve.

## 2 SELECT YOUR POST ACCESSORY & LIGHTING OPTIONS IN MATCHING OR COMPLEMENTARY COLORS



## 3a SELECT YOUR RAIL KIT

- Rail kits include bottom beam, bottom rail, top beam, mounting brackets, mounting hardware, support foot (1 for 6', 2 for 8') and balusters. Available in Satin White only, with square balusters. **If purchasing a full rail kit, skip to Step 5.**

## 3b SELECT YOUR BEAM KIT

- 6' or 8' (true length).
- Can be used for level or stair applications.
- Beam kits include bottom beam, bottom rail, top beam, mounting brackets, mounting screws, support foot.
- Purchase a square/round baluster beam kit or a cable rail beam kit.

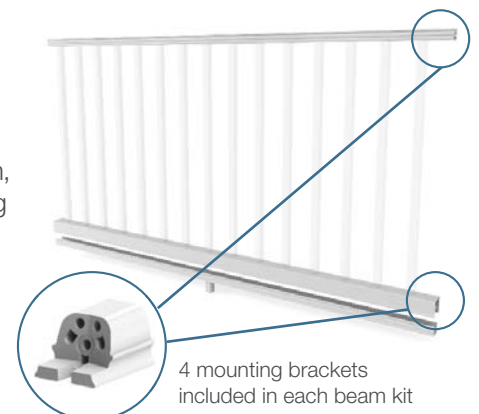

## 4 SELECT YOUR LEVEL OR STAIR BALUSTERS

Square (color of your choice)



- For finished rail heights of 36" & 42".
- Square balusters include baluster plugs.
- Square stair balusters are cut on a 32° angle.

Black Round Aluminum



- For finished rail heights of 36" & 42".
- Baluster shoes sold separately, in boxes of 20.
- Stair baluster shoes are designed for stair angles 32-38°.

Cable Rail Infill



- MUST be installed with wooden 4" x 4" post.
- Purchase your beam kit, cable and fittings.
- Can be used for level and stair application.
- Bottom beam optional – with bottom beam one less pair of fittings would be used.

## 5 SELECT YOUR TOP RAIL



PRESENCE



EMERGE



ASPIRE



GRASPABLE STAIR

## 6 SELECT YOUR GATE KIT OPTION

- 36" & 42" heights, width no wider than 48".
- Purchase rail section and top rail separately - cannot be used with cable rail.
- Gate Kit includes 2 uprights, Boerboel® hardware (2 hinges, 1 latch) and cross braces.



## 7 SELECT YOUR LED ACCESSORIES

Choose from a variety of LED lighting options with easy plug and play installation including under-rail lighting, dome & side lights, all available in Transform's 4 color choices.



# SKU LIST

1a STRUCTURAL POSTS		
DESCRIPTION	FLUSH MOUNT	FASCIA MOUNT
Structural Post for 36" Railing Height	73019022	73019023
Structural Post for 42" Railing Height	73019024	73019025
5" x 5" Post Inserts*	73019139	

1b POST SLEEVES				
DESCRIPTION	SATIN WHITE	CARAMEL	WHEAT	IRONSTONE
5" x 5" x 39" Post Sleeve – Bagged	73019140	N/A	N/A	N/A
5" x 5" x 54" Post Sleeve – Bagged	73019078	N/A	N/A	N/A
5" x 5" x 120" Post Sleeve – Bagged	73014639	N/A	N/A	N/A
5" x 5" x 39" Post Sleeve – Boxed	73014245	73019143	73019142	73019141
5" x 5" x 54" Post Sleeve – Boxed	73014244	73014637	73019079	73014638
5" x 5" x 120" Post Sleeve – Boxed	73014246	73014641	73014640	73014642

\*Post sleeves come with two 5" x 5" post inserts; more can be purchased for use when sleeving 4" x 4" wooden posts with the 120" post sleeve cut to size.

2 POST CAPS & TRIM RINGS				
DESCRIPTION	SATIN WHITE	CARAMEL	WHEAT	IRONSTONE
5" x 5" Pinnacle Post Cap	73019127	73019130	73019129	73019128
5" x 5" Pinnacle LED Post Cap (0.80W)	73019361	73019364	73019363	73019362
5" x 5" Zenith Post Cap	73004495	73004492	73004494	73004493
5" x 5" Zenith LED Post Cap (0.80W)	73019365	73019368	73019367	73019366
5" x 5" Trim Ring	73019038	73014643	73019040	73019039

### 3a RAIL KITS (TOP RAIL SOLD SEPARATELY)

DESCRIPTION	SATIN WHITE
6' x 36" Level Rail Kit with Square Balusters	<b>73019032</b>
8' x 36" Level Rail Kit with Square Balusters	<b>73019033</b>
6' x 42" Level Rail Kit with Square Balusters	<b>73019035</b>
8' x 42" Level Rail Kit with Square Balusters	<b>73019036</b>
6' x 36" Stair Rail Kit with Square Balusters	<b>73019034</b>
6' x 42" Stair Rail Kit with Square Balusters	<b>73019037</b>

INCLUDED IN RAIL KITS	6' LEVEL	8' LEVEL	6' STAIR
1" Beveled Balusters (Includes baluster plugs)	15	20	15
Top Beam	1	1	1
Bottom Beam	1	1	1
Bottom Rail	1	1	1
Brackets	4	4	4
Support Foot	1	2	1
Installation Instructions & Hardware Pack	1	1	1

### 3b BEAM KITS (FOR LEVEL OR STAIR)

DESCRIPTION	SATIN WHITE	CARAMEL	WHEAT	IRONSTONE
6' Beam Kit for Square or Round Balusters	<b>73019061</b>	<b>73019063</b>	<b>73019065</b>	<b>73019067</b>
8' Beam Kit for Square or Round Balusters	<b>73019062</b>	<b>73019064</b>	<b>73019066</b>	<b>73019068</b>
6' Beam Kit for Cable Rail	<b>73019347</b>	<b>73019353</b>	<b>73019349</b>	<b>73019351</b>
8' Beam Kit for Cable Rail	<b>73019348</b>	<b>73019354</b>	<b>73019350</b>	<b>73019352</b>

Beam kits for cable rail include mid baluster support which is required for installation. Cable rail must be installed using a 4" x 4" wooden post to support the cable tension. Bottom rail included in beam kits but optional for cable installation.

INCLUDED IN BEAM KITS	6' KIT	8' KIT
Top Beam	1	1
Bottom Beam	1	1
Bottom Rail	1	1
Brackets	4	4
Mid Baluster Support (In cable rail kits only)	1	2
Support Foot	1	2
Installation Instructions & Hardware Pack	1	1
REQUIRED BEAM KITS USING BALUSTERS	6' KIT	8' KIT
Square or Round Balusters (Sold separately)	15	20

# SKU LIST

4 BALUSTERS				
DESCRIPTION	SATIN WHITE	CARAMEL	WHEAT	IRONSTONE
36" Square Baluster – Level – 10 Pack	73019045	73019049	73019053	73019057
42" Square Baluster – Level – 10 Pack	73019046	73019050	73019054	73019058
36" Square Baluster – Stair – 10 Pack	73019047	73019051	73019055	73019059
42" Square Baluster – Stair – 10 Pack	73019048	73019052	73019056	73019060

Stair balusters are cut at an angle of 32°.

4 ALUMINUM BALUSTERS & ACCESSORIES	
DESCRIPTION	BLACK
36" Round Aluminum Baluster – 10 Pack	73019041
42" Round Aluminum Baluster – 10 Pack	73019042
Aluminum Baluster Shoes – Level – (Box of 20 for 10 balusters)	73019043
Aluminum Baluster Shoes – Stair – (Box of 20 for 10 balusters)	73019044

Aluminum Baluster Shoes for stair installation are designed to work from 32°-38°.

4 CABLE RAIL INFILL & ACCESSORIES		
DESCRIPTION	LEVEL	STAIR
Cable Fitting for 36" Finished Height Installation – Box of 20 (10 sets of fittings)	73019357	73019358
Cable Fitting for 42" Finished Height Installation – Box of 24 (12 sets of fittings)	73019359	73019399
Cable Wire – 100' Length Spool	73019360	
Cable Wire – 500' Length Spool	73019381	
Cable Release Key	73025484	
E-Z Clean Cable Cleaner + Protectant	73040274	

Cable Rail must be installed using a 4" x 4" wooden post to support the cable tension. Bottom rail included in beam kits but optional for cable installation.

5 TOP RAILS				
DESCRIPTION	SATIN WHITE	CARAMEL	WHEAT	IRONSTONE
6' Transform Top Rail – Aspire	73019069	73019075	73019071	73019073
8' Transform Top Rail – Aspire	73019070	73019076	73019072	73019074
6' Transform Top Rail – Emerge	73019080	73019086	73019082	73019084
8' Transform Top Rail – Emerge	73019081	73019087	73019083	73019085
6' Transform Top Rail – Presence	73019088	73019094	73019090	73019092
8' Transform Top Rail – Presence	73019089	73019095	73019091	73019093
6' Transform Graspable Top Rail – For Stairs	73019009	73019012	73019010	73019011

For 45 degree angle railing, the Emerge top rail can be cut at 45 degrees and installed. However, if using the Presence or Aspire top rail, the two adjacent rail sections must be cut at 22.5 degrees and installed on posts mounted at 22.5 degrees. Please contact our customer service department for more information.

6 GATE KITS				
DESCRIPTION	SATIN WHITE	CARAMEL	WHEAT	IRONSTONE
36" Gate Kit	<b>73019237</b>	<b>73019239</b>	<b>73019238</b>	<b>73019240</b>
42" Gate Kit	<b>73019241</b>	<b>73019243</b>	<b>73019242</b>	<b>73019244</b>

Gate kits include 2 uprights, 2 cross braces, Boerboel® hardware (2 hinges, 1 latch). Rail section and top rail sold separately. Satin White gate kit includes white cross braces and black hardware, Caramel, Wheat, and Ironstone gate kits include black cross braces and black hardware. Gates cannot exceed 48" in opening width.

7 LIGHTING ACCESSORIES				
DESCRIPTION	SATIN WHITE	CARAMEL	WHEAT	IRONSTONE
5" x 5" Pinnacle LED Post Cap (0.80W)	<b>73019361</b>	<b>73019364</b>	<b>73019363</b>	<b>73019362</b>
5" x 5" Zenith LED Post Cap (0.80W)	<b>73019365</b>	<b>73019368</b>	<b>73019367</b>	<b>73019366</b>
Dome Light (0.80W)	<b>73019407</b>	<b>73019410</b>	<b>73019408</b>	<b>73019409</b>
Stair/Side Light (0.40W)	<b>73019414</b>	<b>73019417</b>	<b>73019415</b>	<b>73019416</b>
Flush Deck Light (0.40W)	<b>73019403</b>			
LED Under-Rail Lighting (92" strip – 3W)	<b>73019376</b>			
Bluetooth Transformer for LED Lighting	<b>73041277</b>			
Electrical Wire for LED Lighting – 2'	<b>73032449</b>			
Electrical Wire for LED Lighting – 5'	<b>73019375</b>			
Electrical Wire for LED Lighting – 7'	<b>73019373</b>			
Electrical Wire for LED Lighting – 9'	<b>73019374</b>			
2-Way Splitter	<b>73019370</b>			
5-Way Splitter	<b>73019371</b>			

Transformer is 50W and can be used with lighted post caps or under-rail lighting. Includes photocell, built-in dimmer, timer, remote, and is Bluetooth capable. Download the "SmartPower50" app from the iTunes or Android store to control your lighting via your smartphone.

8 EXTRA ACCESSORIES	
DESCRIPTION	
Transform Brackets – Set of 4	<b>73019126</b>
96" Aspire/Presence Top Rail IBC Stiffener – Box of 4	<b>73019002</b>
96" Emerge Top Rail IBC Stiffener – Box of 4	<b>73019003</b>
72" Transform Top Rail Adapter for mix'n'match with RDI Metal Works® Excalibur® (2 + hardware)	<b>73019235</b>
96" Transform Top Rail Adapter for mix'n'match with RDI Metal Works® Excalibur® (2 + hardware)	<b>73019236</b>

For commercial railing heights of 42" with lengths over 91", the IBC stiffener is required for code compliancy.

# ALUMINUM RAILING



**AVALON ALUMINUM RAILING®** comes in rust resistant, sleek aluminum construction. Unique style options combine form, function and versatility to add a rich, stylish look to your home while adding safety and security at the same time. Choose traditional square baluster rail panels, or for a truly high end look, try glass slats for your infill.







# FEATURE SPOTLIGHT

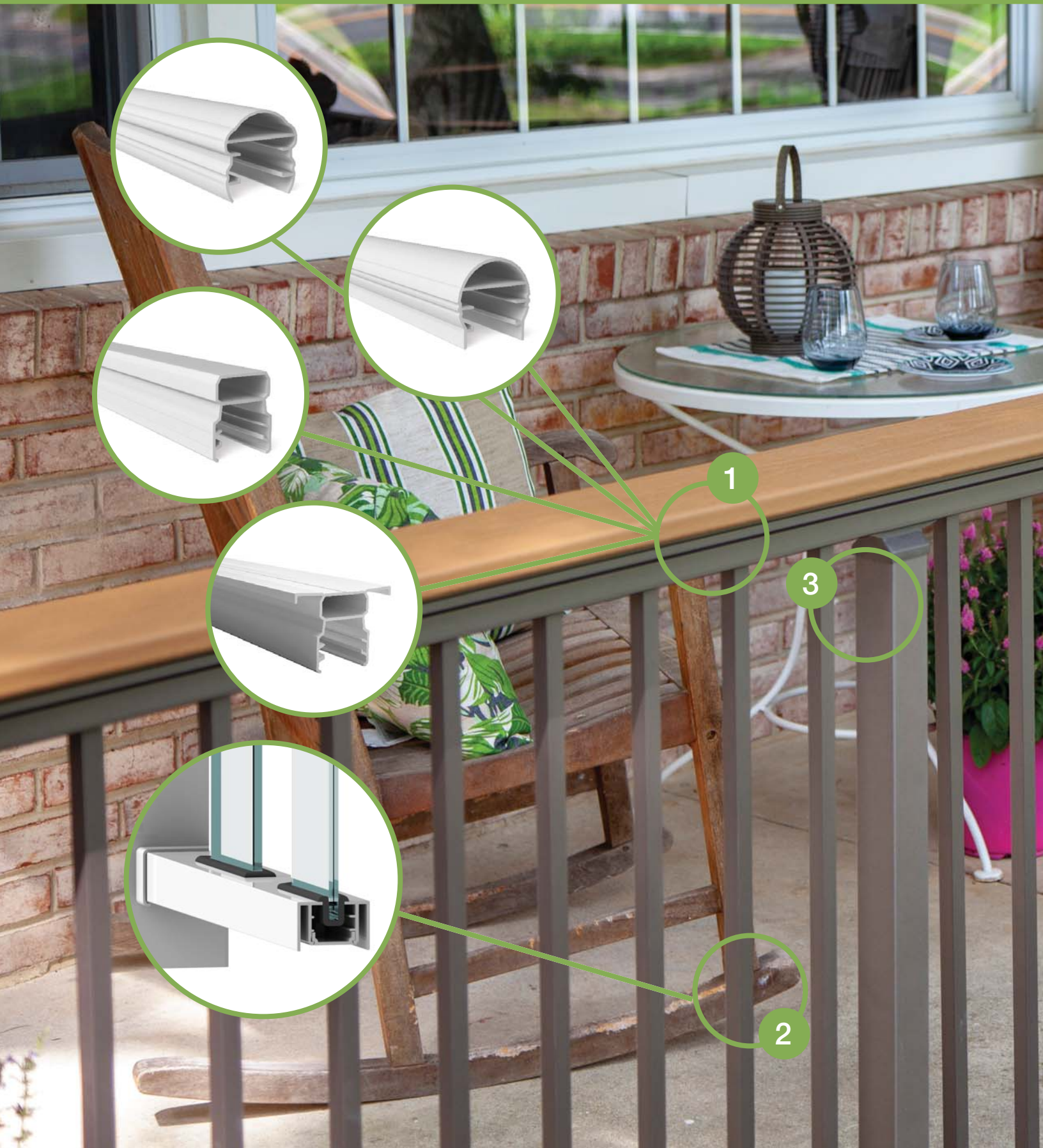

1

3

2



White



Satin Black



Aged Bronze



4

1

### INTERCHANGEABLE TOP RAILS

Choose the top rail that matches your style, from traditional to contemporary. Top rails install quickly and easily and come in 4 different styles and 3 colors.

2

### INFILL OPTIONS

Avalon rail panels with square balusters come pre-assembled for ease of install. If you're looking for something more, try Avalon with glass slats. Glass slats open up your view from your deck without compromising your safety.

3

### EXCEPTIONAL STRENGTH

Durable powder-coated aluminum is AAMA certified and rust proof. And with 10,000 hours of salt-spray testing (used to accelerate corrosion performance of a coating system), Avalon performs at more than 3 times the required standard of 3,000 hours! It exceeds most all commercial and residential codes\* and is supported with a limited lifetime warranty.

4

### SECURATEC<sup>®</sup> LOCKING STRIP

Innovative locking strip, pre-installed into the top and bottom rails, locks in balusters for a secure fit and eliminates rattling.

*\*Avalon Aluminum Railing exceeds U.S. building code requirements. Always consult your local Building Code Department for applicable regulations and product acceptance. For additional information on Avalon visit [www.rdirail.com](http://www.rdirail.com) or contact our Customer Service Department at (877) 420-7245.*

# HOW TO ORDER

## 1 SELECT YOUR POSTS

Avalon posts are available in 3 heights for residential use and 2 heights for commercial application (heavy duty posts) – Step **1a**.

Avalon can also be installed using an over-the-top application. Select which end, corner, or mid posts your over-the-top installation requires (step **1b**), and purchase the corresponding post mounting brackets separately (Step **5**).

4¼" x 4¼" aluminum posts also available for use as structural post (with purchase of mounting kit) or sleeve for structural or wooden posts (step **1c**).

### 1a STANDARD AVALON POSTS

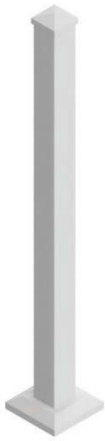

2½" x 2½" Aluminum Post

Posts include connected base plate, sandwich plate, trim ring, post cap, and two vinyl shims. Also available in a heavy duty option for 45" and 60".

### 1b OVER-THE-TOP POST OPTIONS

AVALON PANELS MUST BE CUT UP TO 4" SHORTER THAN TOP RAILS PENDING INSTALL APPLICATION



End Post Configuration



Mid Post Configuration



Corner Post Configuration

2" x 2" Aluminum Over-the-Top Post

Posts include connected base plate, sandwich plate, trim ring and two vinyl shims. Brackets to match top rail style sold separately (step 5). For 42" commercial height, over-the-top spans cannot exceed 6' in length between posts.

### 1c 4¼" X 4¼" CROSSOVER ALUMINUM POST OR SLEEVE OPTIONS

#### a CHOOSE YOUR POST SLEEVE



4¼" x 4¼" x 108" post sleeves can be used as porch columns (5,000 lb load capacity); two mounting kits will be needed in this application.

#### b SELECT YOUR MOUNTING KIT OR TRIM



Mounting kit includes 2-piece trim, mounting plate, and hardware. Trim ring also sold separately if using post as sleeve.

#### c SELECT YOUR POST CAP



Flat Post Cap; not needed if running deck board over the top of your posts.

**1d** If you're installing Avalon using existing 4" x 4" or 6" x 6" wood posts, **1c** offers the ability to sleeve a wooden 4" x 4" post with our aluminum post sleeve, or choose your post options from our **CROSSOVER PRODUCT** (page 84).

## 2 CHOOSE YOUR LEVEL OR STAIR SECTION WITH YOUR INFILL DESIGN



3/4" Square Balusters

Pre-assembled level and stair panels. Level panels include 4 brackets and a support foot. Stair panels include 4 brackets. Top rail sold separately.

**NOTE:** Can be used with any Avalon post system, structural post, or wooden post with post sleeve (1a, 1b, 1c, 1d).



Glass Slats

Beam kit for glass slats; includes 4 brackets and a support foot. Glass slats sold separately. Available for level installation only. Top rail sold separately.

**NOTE:** Can be used with any Avalon post system, structural post, or wooden post with post sleeve (1a, 1b, 1c, 1d).

For 42" commercial height, over-the-top spans cannot exceed 5' in length between posts.

## 3 CHOOSE YOUR TOP RAIL

Top rails are sold separately and include end covers. Top rails must be purchased to complete the installation.



Pellinore™



Lanval™



Tristan™



Oberon™\*

\*Oberon top rail can only be installed as a level application (no angles or stairs). Deck board required to install on top of Oberon.

## 4 ACCESSORY BRACKETS

If needed, purchase separate brackets for additional installation applications – each bracket kit comes with a pair of top and bottom brackets and a pair of top rail end covers specific to whichever top rail profile you've selected.

Level Brackets



Shown with Pellinore top rail and top rail end cover.

Stair Brackets



Shown with Pellinore top rail and top rail end cover.

Level Angle Brackets



Shown with Pellinore top rail and top rail end cover.

End Covers



Pellinore



Lanval



Tristan



Oberon

# HOW TO ORDER

5

## OVER-THE-TOP BRACKETS

Once you've selected your top rail style, select the matching over-the-top post brackets that match your installation plan and posts from step 1b.



Mid Bracket



Corner Bracket



End Bracket

Shown for the Pellinore Top Rail. When using Oberon Top Rail, end bracket covers will be needed for over-the-top end use only; no covers needed for corner or mid over-the-top installations as deck board will run over the top of top rails.

6

## GATE KITS

Gate kits are available in 2 heights to work with 36" and 42" railing. Gate kits include 2 uprights, 2 cross braces, and Boerboel® gate hardware (2 hinges, 1 latch). Simply purchase your rail section and top rail to complete your gate kit installation. Gates cannot exceed 48" in width and cannot be used with glass infill or Oberon Top Rail.



7

## CHOOSE YOUR LIGHTING OPTIONS

Avalon LED post lights are sized specifically for our Avalon posts and are color matched in all 3 Avalon colors.

In addition to lighted post caps, our Crossover Product under-rail lighting gives a unique look and creates ambiance for your deck. Installs quickly and easily with our new plug and play wiring system, and attaches securely with its strong adhesive backing. Simply install the light strip into the light channel and use the supplied adhesive to adhere to your top rail. See page 86 for all the Crossover Product lighting options.



3-in-1 LED Lighted Post Cap

Our 3-in-1 LED lighted post cap offers the options for outward and down lighting; simply connect either or both plugs for whichever option you'd like! Output is 0.8W per light option, 1.6W with both plugs connected.

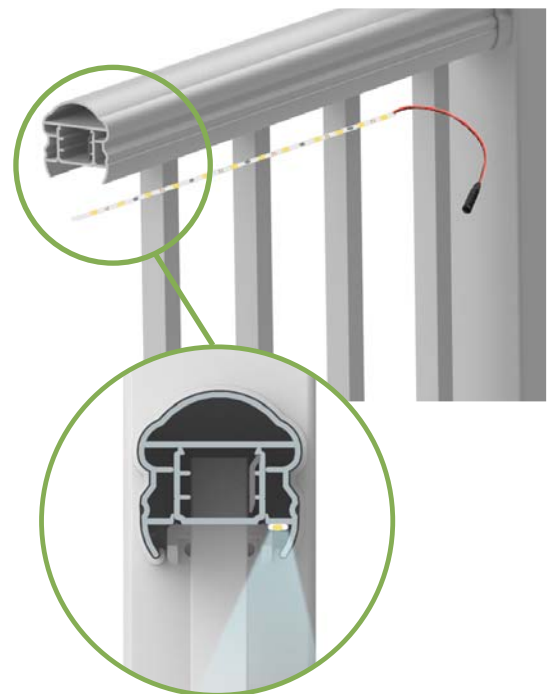

## 1a AVALON – POSTS

DESCRIPTION	WHITE	SATIN BLACK	AGED BRONZE
2½" x 2½" x 39" Post	73020472	73020475	73019473
2½" x 2½" x 45" Post	73020415	73020417	73019475
2½" x 2½" x 45" Heavy Duty Post	73020473	73020476	73019474
2½" x 2½" x 60" Heavy Duty Post	73020474	73020477	73019476

## 1b AVALON – OVER-THE-TOP POSTS

DESCRIPTION	WHITE	SATIN BLACK	AGED BRONZE
2" x 2" x 33" Over-the-Top Post (For 36" finished height)	73020642	73020646	73019470
2" x 2" x 39" Over-the-Top Post (For 42" finished height)	73020643	73020647	73019471

*NOTE: Avalon panels must be cut up to 4" shorter than top rails pending install application.  
For 42" commercial height, over-the-top spans cannot exceed 6' in length between posts*

## 1c CROSSOVER – 4¼" X 4¼" POSTS/SLEEVES

DESCRIPTION	WHITE	SATIN BLACK	AGED BRONZE
4¼" x 4¼" x 39" Post	73041379	73041378	73041376
4¼" x 4¼" x 45" Post	73041383	73041382	73041380
4¼" x 4¼" x 108" Porch Post – 5,000 lb capacity	73041375	73041374	73041372
Flat Post Cap for 4¼" x 4¼" Posts	73041367	73041366	73041364
Trim Ring for 4¼" x 4¼" Posts	73041371	73041370	73041368
Mounting Kit for 4¼" x 4¼" Posts (Includes trim ring)	73041363	73041362	73041360

## 2 AVALON – LEVEL RAIL PANELS

DESCRIPTION	WHITE	SATIN BLACK	AGED BRONZE
6' x 36" Level Rail Panel with Square Balusters	73019269	73019285	73019458
8' x 36" Level Rail Panel with Square Balusters	73019270	73019286	73019464
6' x 42" Level Rail Panel with Square Balusters	73019273	73019289	73019459
8' x 42" Level Rail Panel with Square Balusters	73019274	73019290	73019465

*Avalon Rail Panels can be used with Avalon posts, Avalon over-the-top posts, Transform posts, and Crossover posts.*

## 2 AVALON – STAIR RAIL PANELS

DESCRIPTION	WHITE	SATIN BLACK	AGED BRONZE
6' x 36" Stair Rail Panel with Square Balusters	73019271	73019287	73019466
8' x 36" Stair Rail Panel with Square Balusters	73019272	73019288	73019468
6' x 42" Stair Rail Panel with Square Balusters	73019275	73019291	73019467
8' x 42" Stair Rail Panel with Square Balusters	73019276	73019292	73019469

INCLUDED WITH PANELS	6' LEVEL	8' LEVEL	6' STAIR	8' STAIR
Fully Assembled Panel	1	1	1	1
Bracket Set (2 top, 2 bottom, mounting screws)	1	1	1	1

# SKU LIST

## 2 AVALON – GLASS LEVEL RAIL KITS - GLASS SLATS SOLD SEPARATELY

DESCRIPTION	WHITE	SATIN BLACK	AGED BRONZE
6' Beam Kit for Glass Slats (level only)	<b>73020648</b>	<b>73020652</b>	<b>73019454</b>
8' Beam Kit for Glass Slats (level only)	<b>73020649</b>	<b>73020653</b>	<b>73019460</b>

6' kits require 9 glass slats and 8' kits require 12 glass slats (sold separately). Top and bottom gaskets for glass slats included with rail kits.

INCLUDED WITH GLASS RAIL KITS	6' KIT	8' KIT
Top Beam	1	1
Bottom Rail	1	1
Glass Slat Gaskets (top and bottom)	18	24
Bracket Kit (4 level brackets, mounting hardware)	1	1
Support Foot	1	2

## 2 CROSSOVER – GLASS SLATS

DESCRIPTION	For 36" Rail Height	For 42" Rail Height
Glass Slats for Level Kits – Box of 9 – For Use with 6' Kits	<b>73041331</b>	<b>73041332</b>
Glass Slats for Level Kits – Box of 12 – For Use with 8' Kits	<b>73041333</b>	<b>73041334</b>

## 3 AVALON – TOP RAILS – INCLUDES MATCHING END COVERS (2 EACH)

DESCRIPTION	WHITE	SATIN BLACK	AGED BRONZE
6' Top Rail – Pellinore	<b>73020442</b>	<b>73020448</b>	<b>73019456</b>
8' Top Rail – Pellinore	<b>73020443</b>	<b>73020449</b>	<b>73019462</b>
6' Top Rail – Lanval	<b>73020444</b>	<b>73020450</b>	<b>73019455</b>
8' Top Rail – Lanval	<b>73020445</b>	<b>73020451</b>	<b>73019461</b>
6' Top Rail – Tristan	<b>73020446</b>	<b>73020452</b>	<b>73019457</b>
8' Top Rail – Tristan	<b>73020447</b>	<b>73020453</b>	<b>73019463</b>
6' Top Rail – Oberon*	<b>73032049</b>	<b>73032042</b>	<b>73032048</b>
8' Top Rail – Oberon*	<b>73032052</b>	<b>73032050</b>	<b>73032051</b>

\*Oberon top rail is intended for level applications only. Deck board must be installed on top of Oberon profile.



## 4 AVALON – BRACKETS

DESCRIPTION	WHITE	SATIN BLACK	AGED BRONZE
Pellinore Level Bracket Kit (Set of 4 – 2 top, 2 bottom)	<b>73019301</b>	<b>73019298</b>	<b>73019490</b>
Pellinore Stair Bracket Kit (Set of 4 – 2 top, 2 bottom)	<b>73019310</b>	<b>73019307</b>	<b>73019491</b>
Pellinore Angle Bracket Kit (Set of 4 – 2 top, 2 bottom)	<b>73019318</b>	<b>73019319</b>	<b>73019489</b>
Lanval Level Bracket Kit (Set of 4 – 2 top, 2 bottom)	<b>73019299</b>	<b>73019296</b>	<b>73019484</b>
Lanval Stair Bracket Kit (Set of 4 – 2 top, 2 bottom)	<b>73019308</b>	<b>73019305</b>	<b>73019485</b>
Lanval Angle Bracket Kit (Set of 4 – 2 top, 2 bottom)	<b>73019312</b>	<b>73019313</b>	<b>73019483</b>
Tristan Level Bracket Kit (Set of 4 – 2 top, 2 bottom)	<b>73019300</b>	<b>73019297</b>	<b>73019496</b>
Tristan Stair Bracket Kit (Set of 4 – 2 top, 2 bottom)	<b>73019309</b>	<b>73019306</b>	<b>73019497</b>
Tristan Angle Bracket Kit (Set of 4 – 2 top, 2 bottom)	<b>73019315</b>	<b>73019316</b>	<b>73019495</b>
Oberon Level Bracket Kit (Set of 4 – 2 top, 2 bottom)	<b>73040784</b>	<b>73040785</b>	<b>73040786</b>

## 5 AVALON – OVER-THE-TOP BRACKETS

DESCRIPTION	WHITE	SATIN BLACK	AGED BRONZE
Pellinore 2" Over-the-Top Post Bracket – Mid Post	<b>73020663</b>	<b>73020681</b>	<b>73019487</b>
Pellinore 2" Over-the-Top Post Bracket – Corner Post	<b>73020664</b>	<b>73020682</b>	<b>73019486</b>
Pellinore 2" Over-the-Top Post Bracket – End Post	<b>73020665</b>	<b>73020683</b>	<b>73019488</b>
Lanval 2" Over-the-Top Post Bracket – Mid Post	<b>73020660</b>	<b>73020678</b>	<b>73019482</b>
Lanval 2" Over-the-Top Post Bracket – Corner Post	<b>73020661</b>	<b>73020679</b>	<b>73019480</b>
Lanval 2" Over-the-Top Post Bracket – End Post	<b>73020662</b>	<b>73020680</b>	<b>73019481</b>
Tristan 2" Over-the-Top Post Bracket – Mid Post	<b>73020666</b>	<b>73020684</b>	<b>73019494</b>
Tristan 2" Over-the-Top Post Bracket – Corner Post	<b>73020667</b>	<b>73020685</b>	<b>73019492</b>
Tristan 2" Over-the-Top Post Bracket – End Post	<b>73020668</b>	<b>73020686</b>	<b>73019493</b>
Oberon 2" Over-the-Top Post Bracket – Mid Post*	<b>73040798</b>	<b>73040797</b>	<b>73040799</b>
Oberon 2" Over-the-Top Post Bracket – Corner Post*	<b>73040801</b>	<b>73040800</b>	<b>73040802</b>
Oberon 2" Over-the-Top Post Bracket – End Post	<b>73040788</b>	<b>73040787</b>	<b>73040796</b>

\*Does not include bracket covers; deck board will install over the top of Oberon top rail.

## 6 AVALON – GATE KITS

DESCRIPTION	WHITE	SATIN BLACK	AGED BRONZE
36" Gate Kit	<b>73020655</b>	<b>73020654</b>	<b>73019478</b>
42" Gate Kit	<b>73020658</b>	<b>73020657</b>	<b>73019479</b>

Gate Kits include uprights, cross braces, and Boerboel<sup>®</sup> gate kit hardware (2 hinges, 1 gravity latch – black only). Complete your gate by purchasing your rail panel and top rail separately. Gate kits cannot be used with Avalon glass and cannot exceed widths of 48".

## 7 AVALON – LED POST CAPS

DESCRIPTION	WHITE	SATIN BLACK	AGED BRONZE
3-in-1 LED Lighted Post Cap (1.6W)	<b>73021946</b>	<b>73021947</b>	<b>73021948</b>

If using the LED lighted post cap, select your wiring accessories from our selection of plug-and-play options on page 86.

# STEEL RAILING



# METALWORKS EXCALIBUR®



## METALWORKS® EXCALIBUR®

Metal Works Excalibur brings you strength and security in steel railing. Excalibur features hidden attachments and pre-attached brackets, allowing for ease of installation. Available in textured Satin Black and hammered Bronze finishes along with accessories to help you customize your install with a deck board top, Excalibur gives you the strength of steel in a traditional style and timeless style.

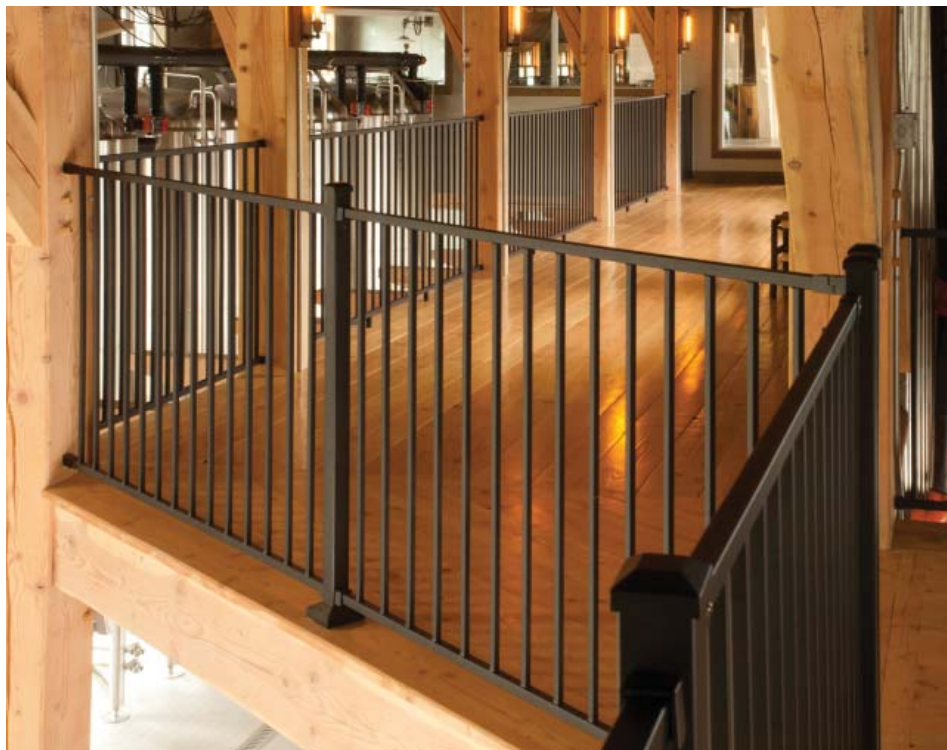

# FEATURE SPOTLIGHT

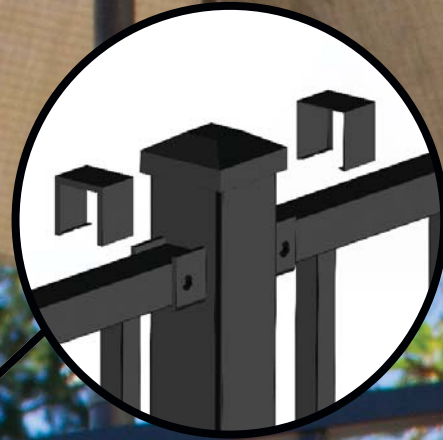

1

## 2" x 2" BRACKETED POSTS

Pre-attached level brackets means no measuring, pre-drilling, or attaching brackets to the posts and ensures consistent code-compliant bottom spacing (available for both 2" and 4" bottom space heights) and finished rail height. Metal Works Excalibur posts are available in corner, mid, end, and blank post configurations for any installation you need!

2

## ALL-IN-ONE PIVOTING BRACKETS

Our unique all-in-one pivoting brackets allow attachment at virtually any stair pitch or level angle without difficult miter cuts.

3

## TRIPLE-COAT SATIN BLACK & HAMMERED BRONZE FINISHES

Components are fully welded prior to immersion in a zinc phosphate bath. They are then galvanized prior to an electrostatically applied powder coat finish which is baked for maximum durability. The low gloss Satin Black and textured, hammered Bronze finishes help hide marring, fingerprints, and dirt.

4

## FULLY ASSEMBLED, FACTORY-WELDED RAIL PANELS

Assembled and welded rail panels save valuable installation time. The process is as easy as: measure, cut and install.

*The Metal Works Excalibur Railing System exceeds U.S. building code requirements. Always consult your local Building Code Department for applicable regulations and product acceptance. For additional information on Excalibur or other RDI products visit [www.rdirail.com](http://www.rdirail.com) or contact our Customer Service Department at (877) 420-7245.*

# METALWORKS EXCALIBUR®



# HOW TO ORDER

## 1 SELECT YOUR POST OPTIONS

Excalibur 2" x 2" posts come with three options with pre-mounted brackets and 2 blank post options for more customized installations. Excalibur 3" x 3" posts come as blank posts; purchase your brackets separately.

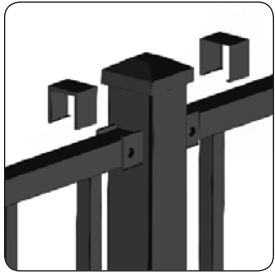

Mid Post

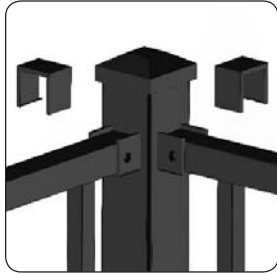

Corner Post



End Post

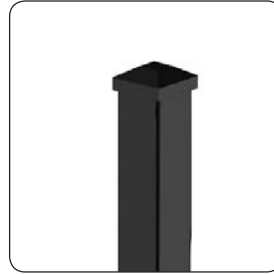

Blank Post

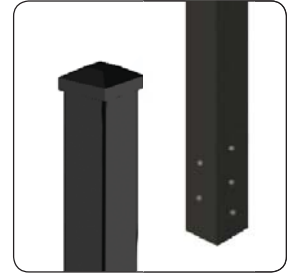

Fascia Post

Excalibur bracketed posts come with welded base plates, pre-attached brackets, pre-mounted post top, bracket covers, two-piece trim ring, and vinyl shims.

Blank posts come with welded base plates, pre-mounted post top, two-piece trim ring and vinyl shims.

Fascia post comes with pre-mounted post top and vinyl shims. Brackets sold separately.



Fascia Post shown with brackets

## 2 CHOOSE LEVEL OR STAIR SECTIONS

Factory welded pre-assembled level and stair panels make installation simple! Available in 34" and 40" height for varying finished rail heights depending on bottom space on post.

Level Panels

6'  
8'  
10'



Stair Panels

6'  
8'



Panels have a 1" profile top and bottom rail and  $\frac{5}{8}$ " picket infill.

# METALWORKS EXCALIBUR®

3

## CHOOSE YOUR BRACKETS

Mid, corner, and end posts all include brackets for level rail installation. Stair brackets must be purchased separately. If installing Excalibur onto existing posts, level brackets may also be purchased separately.



Level Brackets



Stair Bracket (can also be used for level angle)



Fascia Brackets

4

## CUSTOMIZE WITH ACCESSORIES

Customize your Excalibur installation by using our flush mount brackets to mount any type of deck board to the top of your railing or add an LED lighted post cap.

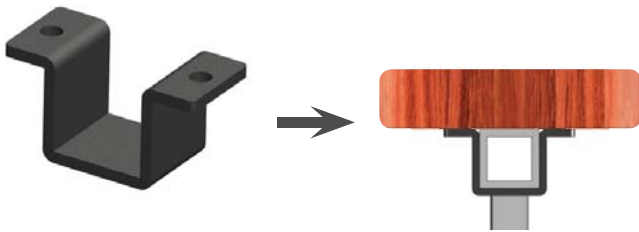

Flush Mount Bracket



LED Down Light Post Cap  
(0.80W – 2" or 3")

5

## GATES

If needed, purchase your gate – (finished gate opening is 36") or gate kit ends for 36" – 38" or 42" – 44" installed height (use with rail panel – purchase separately).



Pre-Assembled Gate



Gate Ends

# SKU LIST

## 1 METAL WORKS EXCALIBUR – POSTS

DESCRIPTION	SATIN BLACK	BRONZE
2" x 2" x 38" Mid Post Assembly for 36" Rail with 2" Bottom Space	73018345	73018346
2" x 2" x 38" End Post Assembly for 36" Rail with 2" Bottom Space	73018336	73018337
2" x 2" x 38" Corner Post Assembly for 36" Rail with 2" Bottom Space	73018326	73018327
2" x 2" x 44" Mid Post Assembly for 42" Rail with 2" Bottom Space	73018349	73018350
2" x 2" x 44" End Post Assembly for 42" Rail with 2" Bottom Space	73018339	73018340
2" x 2" x 44" Corner Post Assembly for 42" Rail with 2" Bottom Space	73018330	73018331
2" x 2" x 40" Mid Post Assembly for 38" Rail with 4" Bottom Space	73018347	73018348
2" x 2" x 40" End Post Assembly for 38" Rail with 4" Bottom Space	73018021	73018338
2" x 2" x 40" Corner Post Assembly for 38" Rail with 4" Bottom Space	73018023	73018328
2" x 2" x 38" Blank Post for 36" Rail (Brackets sold separately)	73018315	73018316
2" x 2" x 40" Blank Post for 38" Rail (Brackets sold separately)	73018317	73018022
2" x 2" x 44" Blank Post for 42" Rail (Brackets sold separately)	73018318	73018319
2" x 2" x 46" Blank Post for 44" Rail (Brackets sold separately)	73018320	73018321
2" x 2" x 48" Blank Post (Brackets sold separately)	73018322	73018323
2" x 2" x 52" Fascia Mount Post (Fascia brackets sold separately)	73019191	73019192
3" x 3" x 40" Blank Post for 36" to 38" Rail (Brackets sold separately)	73032020	73032021
3" x 3" x 46" Blank Post for 36" to 44" Rail (Brackets sold separately)	73032022	73032023

You may need to purchase a longer blank post for stair application depending on your installation scenario.

## 2 METAL WORKS EXCALIBUR – RAIL PANELS

DESCRIPTION	SATIN BLACK	BRONZE
6' x 34" Level Rail Panel – Square Baluster	73018004	73018298
8' x 34" Level Rail Panel – Square Baluster	73018024	73018016
10' x 34" Level Rail Panel – Square Baluster*	73018015	73018291
6' x 34" Stair Rail Panel – Square Baluster	73018019	73018304
8' x 34" Stair Rail Panel – Square Baluster	73018310	73018311
6' x 40" Level Rail Panel – Square Baluster	73018299	73018300
8' x 40" Level Rail Panel – Square Baluster	73018018	73018303
8' x 40" Stair Rail Panel – Square Baluster	73018020	73018314

34" panels can be installed at a finished rail height of 36" with 2" bottom space or 38" with 4" bottom space.

40" panels can be installed at a finished rail height of 42" with 2" bottom space or 44" with 4" bottom space.

\*10' Excalibur panels can be used to cut down to shorter lengths or for long spans where code compliance is not required.

INCLUDED WITH PANELS	6' LEVEL	8' LEVEL	10' LEVEL	6' STAIR	8' STAIR
Fully Assembled Panel	1	1	1	1	1
Brackets	0	0	0	0	0



# METALWORKS EXCALIBUR®

## 1 METAL WORKS EXCALIBUR – POSTS – CALIFORNIA ONLY\*

DESCRIPTION	SATIN BLACK	BRONZE
2" x 2" x 44" Mid Post Assembly for 42" Rail with 4" Bottom Space	73018046	73018047
2" x 2" x 44" End Post Assembly for 42" Rail with 4" Bottom Space	73018044	73018045
2" x 2" x 44" Corner Post Assembly for 42" Rail with 4" Bottom Space	73018043	73018329

## 2 METAL WORKS EXCALIBUR – RAIL PANELS – CALIFORNIA ONLY\*

DESCRIPTION	SATIN BLACK	BRONZE
6' x 38 ¼" Level Rail Panel – Square Baluster	73018030	73018031
8' x 38 ¼" Level Rail Panel – Square Baluster	73018032	73018033
6' x 32 ¼" Stair Rail Panel – Square Baluster	73018034	73018035
8' x 32 ¼" Stair Rail Panel – Square Baluster	73018036	73018309

\* These SKUs are CA code compliant and only housed in our west coast warehouse. They are for distribution in CA only.

INCLUDED WITH PANELS	6' LEVEL	8' LEVEL	10' LEVEL	6' STAIR	8' STAIR
Fully Assembled Panel	1	1	1	1	1
Brackets	0	0	0	0	0

## 3 METAL WORKS EXCALIBUR – BRACKETS

DESCRIPTION	SATIN BLACK	BRONZE
Bracket Kit for Level Rail	73018013	73018025
Bracket Kit for Stair or Level Angle Rail	73018014	73018026
Fascia Post Bracket Kit – Mounting Hardware Not Included – For 2" Posts Only	73019193	73019194

## 4 METAL WORKS EXCALIBUR – ACCESSORIES

DESCRIPTION	SATIN BLACK	BRONZE
2" LED Post Cap (0.80W)	73043000	N/A
3" LED Post Cap (0.80W)	73043001	N/A
Top Cap Flush Bracket Kit (Set of 4)	73018886	73018887
Rail Cutting Jig	73018283	

To see all the LED lighting options and details, see our Crossover LED Lighting on page 86.

## 5 METAL WORKS EXCALIBUR – GATES

DESCRIPTION	SATIN BLACK	BRONZE
34" x 36" Gate, Assembled for 36"– 38" Rail – 36" Finished Opening	73018268	N/A
Gate Ends for 36"– 38" Rail – Custom Width – Rail Panel Sold Separately	73018276	73018277
Gate Ends for 42" Rail – Custom Width – Rail Panel Sold Separately (CA only)	73018278	73018279
Gate Ends for 42"– 44" Rail – Custom Width – Rail Panel Sold Separately	73018280	73018281
Boerboel® Hardware – Compact Butterfly Hinge Kit Pair (Black aluminum)	73024441	
Boerboel® Hardware – Gravity Latch (Black steel)	73024440	

# VINYL RAILING



**ENDURANCE® ORIGINAL RAIL™** is our fully kitted railing system – with everything you need to build out your railing in one box. Simple form and dependable function unite this railing design to maintain safety without sacrificing the elegant presentation of your home or commercial space. Kits are available in your choice of balusters: square, turned, or round aluminum.

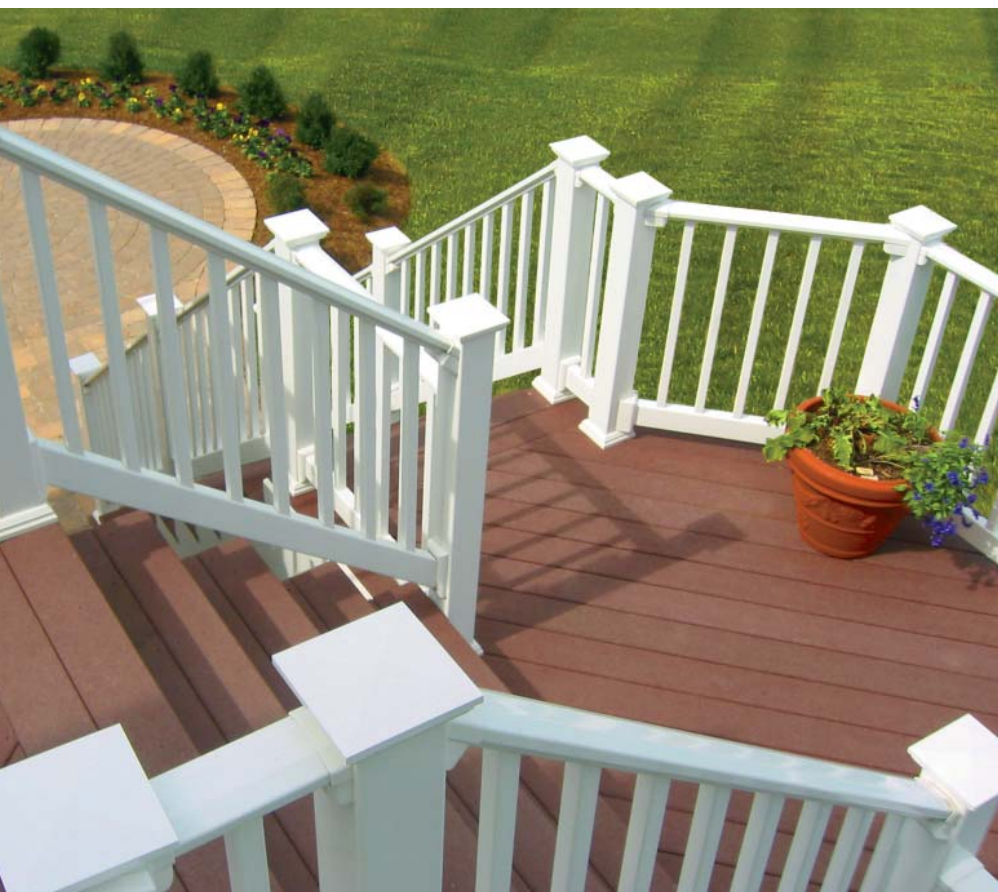

*Endurance*<sup>®</sup>  
ORIGINAL RAIL™

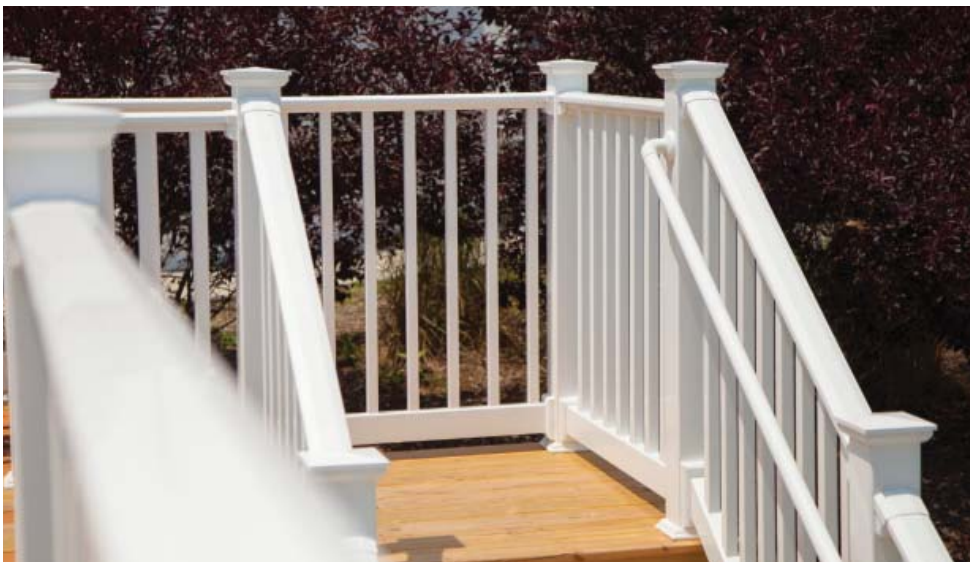

# FEATURE SPOTLIGHT



1

## 1 SECURE INTERLOCKING BRACKET COMPONENTS

Endurance Original brackets install simply by attaching the body of the bracket to the mounting surface and then snapping the bracket covers into place over the fasteners. Snap-fit design ensures a secure fit and clean appearance.

## 2 BRACKETS INCLUDED IN KITS

All level and stair kits include brackets in addition to a full line of accessory brackets.

3

## 3 EASY STAIR INSTALLATION

No-cut stair brackets install easily to accommodate 32° – 38° stair angles. Bottom stair brackets include quick-fit inserts to accommodate low and high stair angles; no complicated measuring or cutting.

4

## 4 ENGINEERED STRENGTH

The aluminum stiffener adds strength and support to the vinyl profile and runs the length of the top and bottom lineals.

*The Endurance Original Rail System exceeds U.S. building code requirements and has been independently tested by PFS laboratories, a third-party, ICC-ES certified testing and inspection agency. Always consult your local Building Code Department for applicable regulations and product acceptance. For additional information on Endurance or other RDI products visit [www.rdirail.com](http://www.rdirail.com) or contact our Customer Service Department at (877) 420-7245.*

# Endurance<sup>®</sup>

ORIGINAL RAIL™

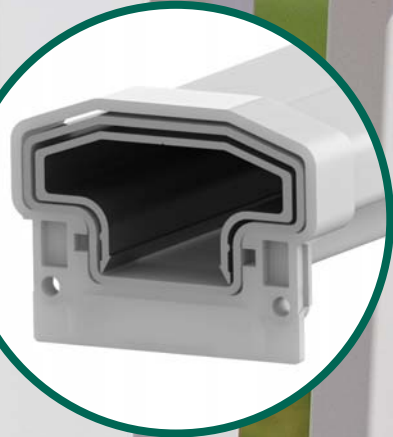
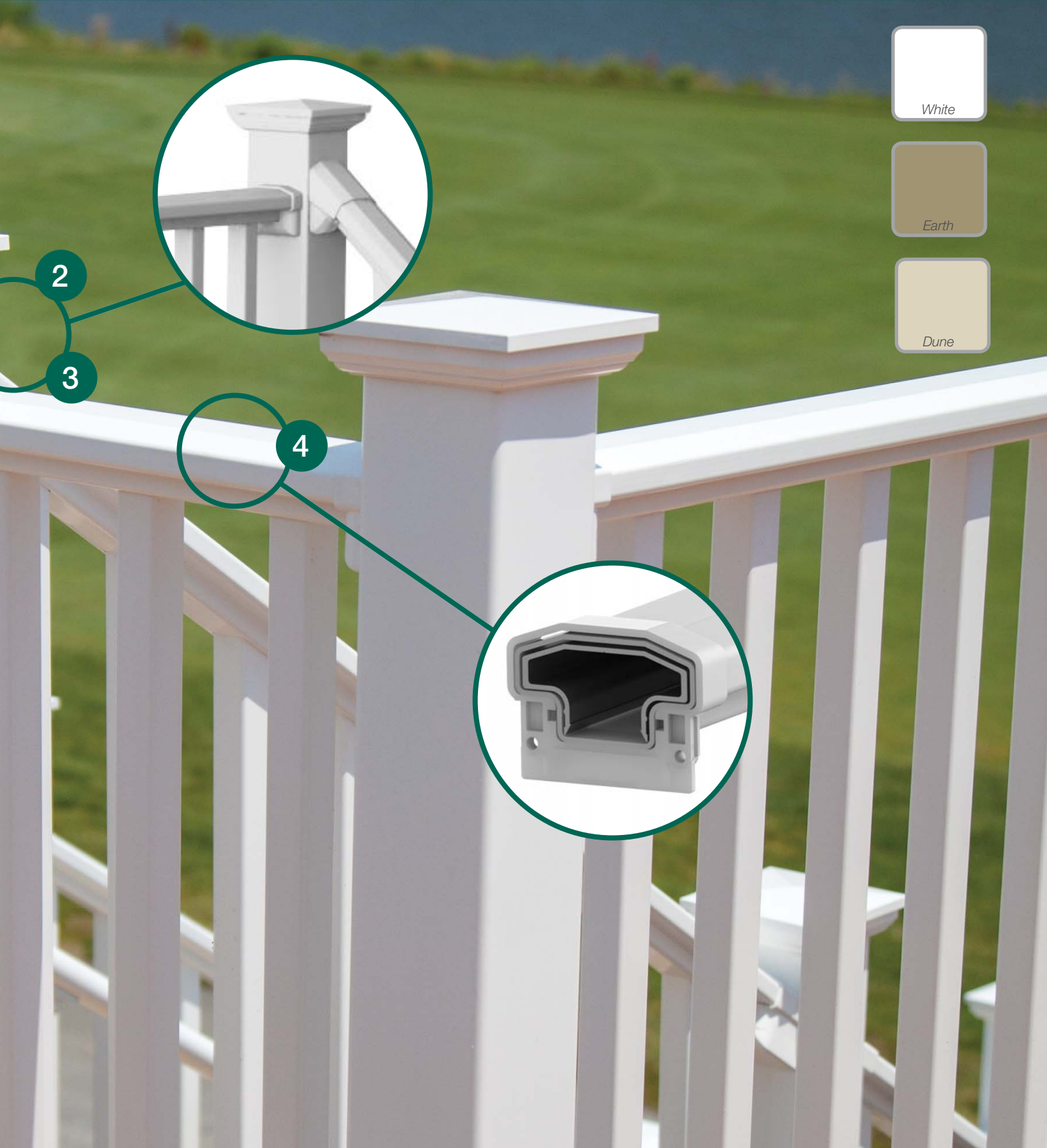

# HOW TO ORDER

**1** SELECT YOUR POST & POST ACCESSORY OPTIONS. SEE PAGE 84 FOR CROSSOVER PRODUCT.

**a** CHOOSE A POST SLEEVE



**b** CHOOSE A TRIM RING

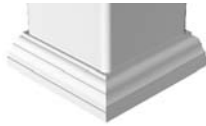

**c** CHOOSE A POST CAP

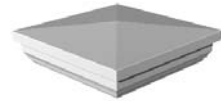

**2** CHOOSE YOUR LEVEL AND STAIR SECTIONS.

(Square balusters shown. See below for all baluster styles). All kits available in 36" height (with 2" bottom space), square baluster kits also available in 42" height (with a 2" bottom space).

Level Kits

4'\*

6'

8'

10'\*

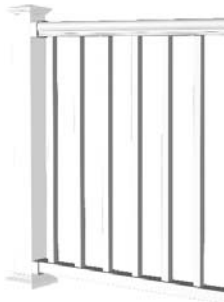

Support Foot

Required for level sections over 8' in length



2" - 4" Level Rail Support Kit

Stair Kits

6'

8'\*



\*4' level kits not available for round aluminum, turned, or glass. 10' level kits not available for glass.

## BALUSTER STYLES



Square Balusters  
(1 1/4")



Turned Balusters  
(1 1/4")



Black Round Balusters  
(3/4" Round Aluminum)



Glass Slats  
(Level only - sold separately from rail kit)

### 3 ACCESSORY BRACKET KITS

Endurance Original Rail kits come with the level or stair brackets needed for each kit. Original Rail also offers a full line of accessory brackets for other railing installation applications.



Level Mounting  
Bracket Kit



Stair Mounting  
Bracket Kit



0° – 44° Level  
Bracket Kit\*



45° Mounting  
Bracket Kit



Round Column  
Mounting  
Bracket Kit



Paintable Round  
Column Bracket  
Adapter Kit

\*Maximum straight cut for the 0° – 44° bracket is 32°. For angles of 33° – 44°, bracket must be v-notch cut.

### 4 CHOOSE YOUR GATE KIT

Standard gate kits (36" wide opening) are available in 2 heights to work with 36" and 42" railing and are compatible with all vinyl rail systems. Custom gates available in 36" and 42" finished heights and cannot exceed 48" in width. Gate hardware sold separately.



### 5 CHOOSE YOUR LIGHTING OPTIONS

In addition to solar and LED post caps, our under-rail lighting gives a unique look and creates ambiance for your deck. Installs quickly and easily with our new plug and play wiring system, and attaches securely with its strong adhesive backing. Simply install the light strip into the light channel and use supplied adhesive to adhere to your top rail. See page 86 in Crossover Product for details on lighting systems.

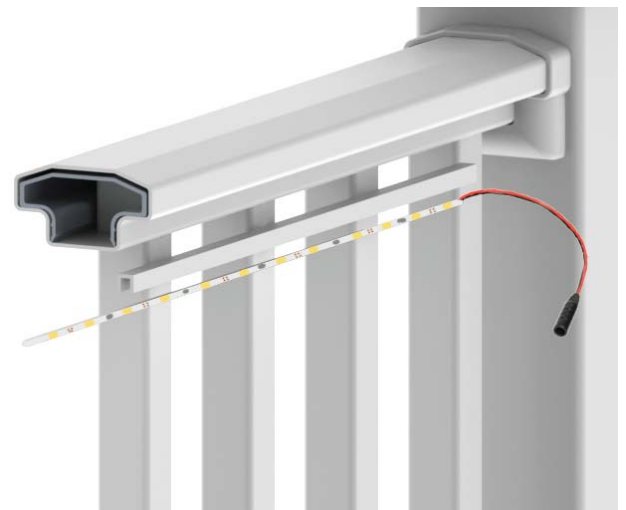

# SKU LIST

**1** For other post options (including 4" x 4", 6" x 6", and structural posts) and additional accessories see our Crossover Product section on page 84.

## **2** ENDURANCE ORIGINAL RAIL – 1¼" SQUARE BALUSTER KITS

DESCRIPTION	WHITE	EARTH	DUNE
4' x 36" H – Level Rail Kit	73018509	N/A	N/A
6' x 36" H – Level Rail Kit	73018009	73018527	73041395
8' x 36" H – Level Rail Kit	73018000	73018537	73041396
10' x 36" H – Level Rail Kit	73018498	N/A	N/A
6' x 36" H – 32° to 38° Stair Rail Kit	73019104	73019102	73041397
8' x 36" H – 32° to 38° Stair Rail Kit	73019116	73019114	73041398
6' x 42" H – Level Rail Kit	73018705	73018706	73041399
8' x 42" H – Level Rail Kit	73018708	73018709	73041400
6' x 42" H – 32° to 38° Stair Rail Kit	73019113	73019111	73041401
8' x 42" H – 32° to 38° Stair Rail Kit	73019125	73019123	73041402

## **2** ENDURANCE ORIGINAL RAIL – ¾" ROUND ALUMINUM BALUSTER KITS

DESCRIPTION	WHITE	EARTH	DUNE
6' x 36" H – Level Rail Kit	73018553	73018554	73041404
8' x 36" H – Level Rail Kit	73018558	73018559	73041405
10' x 36" H – Level Rail Kit	73018547	N/A	N/A
6' x 36" H – 32° to 38° Stair Rail Kit	73019110	73019108	73041406
8' x 36" H – 32° to 38° Stair Rail Kit	73019122	73019120	73041407

## **2** ENDURANCE ORIGINAL RAIL – 1¼" TURNED BALUSTER KITS

DESCRIPTION	WHITE
6' x 36" H – Level Rail Kit – 1¼" Turned Baluster	73018633
8' x 36" H – Level Rail Kit – 1¼" Turned Baluster	73018636
10' x 36" H – Level Rail Kit – 1¼" Turned Baluster	73018626
6' x 36" H – 32° to 38° Stair Rail Kit – 1¼" Turned Baluster	73019107
8' x 36" H – 32° to 38° Stair Rail Kit – 1¼" Turned Baluster	73019119

## **2** ENDURANCE ORIGINAL RAIL – GLASS SLAT KITS (SLATS SOLD SEPARATELY)

DESCRIPTION	WHITE
6' Level Rail Kit – for Glass Slats – Requires 9 Level Glass Slats	73018530
8' Level Rail Kit – for Glass Slats – Requires 12 Level Glass Slats	73018540



### 2 ENDURANCE ORIGINAL RAIL – GLASS SLATS

DESCRIPTION	36"	42"
Glass Slats for Level Kits – Box of 9 – For Use with 6' Kits	<b>73041331</b>	<b>73041332*</b>
Glass Slats for Level Kits – Box of 12 – For Use with 8' Kits	<b>73041333</b>	<b>73041334*</b>

\*42" glass slats for residential use only.

INCLUDED IN KITS	4' LEVEL	6' LEVEL	8' LEVEL	10' LEVEL	6' STAIR	8' STAIR
1¼" Balusters (Square/turned)	9*	14	19	24	11	15
¾" Balusters (Round aluminum)	N/A	15	20	26	14	19
Glass Slats	N/A	0	0	N/A	0	N/A
Top Vinyl Rail	1	1	1	1	1	1
Top Aluminum Stiffener	1	1	1	1	1	1
Bottom Vinyl Rail	1	1	1	1	1	1
Bottom Aluminum Stiffener	1	1	1	1	1	1
Bracket Kit (2 top, 2 bottom)	1	1	1	1	1	1
Support Foot (Glass kits only)**	N/A	1	1	N/A	0	0

\*4' kits only available in 1¼" square balusters, not available for turned balusters.

\*\* Support foot required for glass railing sections 6' to 8'.

### 3 ENDURANCE ORIGINAL RAIL – ACCESSORIES

DESCRIPTION	WHITE	EARTH	DUNE
Level Mounting Bracket Kit – 2 Pairs	<b>73019016</b>	<b>73019018</b>	<b>73041408</b>
Stair Mounting Bracket Kit – 2 Pairs	<b>73019017</b>	<b>73019019</b>	<b>73041409</b>
Round Column Mounting Bracket Kit – 1 Pair	<b>73018115</b>	<b>73018113</b>	<b>73041410</b>
Paintable Round Column Mounting Bracket Adapter Kit – 1 Pair	<b>73018116</b>	<b>N/A</b>	<b>N/A</b>
0° to 44° Level Mounting Bracket Kit – 1 Pair	<b>73018065</b>	<b>73018017</b>	<b>73041411</b>
45° Level Mounting Bracket Kit – 1 Pair	<b>73018086</b>	<b>73018084</b>	<b>73041412</b>
2" – 4" Level Rail Support Kit	<b>73018129</b>	<b>73018127</b>	<b>73041494</b>

Level rail support required for lengths over 8'. Endurance Original Rail kits (except glass kits) do not include a support foot.

4 For gate options, see our Crossover gates on page 87.

5 To see all the LED lighting options and details, see our Crossover LED Lighting on page 86.

# VINYL RAILING



**FINYL LINE™** low-maintenance vinyl railing, reinforced with strong aluminum, adds character to your home while providing safety and security. Easy to install and code compliant for residential (IRC) & commercial (IBC), Finyl Line is sure to meet your railing needs. Select from a traditional T-Top profile or a Deck Top profile, and your choice of traditional square, elegant turned and classic round aluminum balusters with kits available in White, Earth, or Dune. Finyl Line is supported by a full range of accessories including post sleeves, post caps & trims, and LED lighting options.





# FEATURE SPOTLIGHT





White



Earth



Dune

4

1

### ENGINEERED STRENGTH

Finyl Line's top and bottom aluminum stiffeners add strength and support to the vinyl profile and run the full length of the lineals ensuring a strong rail that won't sag.

2

### BRACKETS INCLUDED IN KITS

Brackets are included with rail kits and are available separately in level, stair, and angle, along with 22.5°, 45°, and round column adapter kits. Brackets include bracket screw covers that snap onto bracket sides for a clean finished look with no exposed hardware. Bracket kits include hardware for installation.

3

### STYLE OPTIONS

Finyl Line railing kits are available with 1½" square or turned balusters or ¾" black round aluminum balusters and 36" or 42" heights.

4

### TOP RAIL PROFILES

Choose the top rail that creates the look you want! Finyl Line offers a traditional T-Top style top rail or a Deck Top rail that allows you to add a deck board to create a drink top surface for your railing.

*The Finyl Line Rail System exceeds U.S. building code requirements and has been independently tested by PFS laboratories, a third-party, ICC-ES certified testing and inspection agency. Always consult your local Building Code Department for applicable regulations and product acceptance. For additional information on Finyl Line or other RDI products visit [www.rdirail.com](http://www.rdirail.com) or contact our Customer Service Department at (877) 420-7245.*

# HOW TO ORDER

**1** SELECT YOUR POST & POST ACCESSORY OPTIONS. SEE PAGE 84 FOR CROSSOVER PRODUCT.

**a** CHOOSE A POST SLEEVE



**b** CHOOSE A TRIM RING

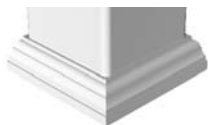

**c** CHOOSE A POST CAP

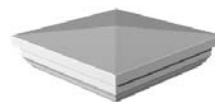

**2** CHOOSE YOUR T-TOP OR DECK TOP LEVEL AND STAIR SECTIONS.

(Square balusters shown. See below for all baluster styles). Kits available in 36" height (with 2" bottom space); square baluster kits also available in 42" height (with a 2" bottom space).

Top Rail Profiles



T-Top Profile



Deck Top Profile

Level Kits

4'\*

5'\*

6'

8'

10'\*



\*Select colors and styles not available in 4', 5', and 10' lengths.

Stair Kits

6'\*

8'



\*Select colors and styles not available in 6' stair kits.

**3** BALUSTER STYLES



Square Balusters  
(1½")



Turned Balusters  
(1½")



Black Round Balusters  
(¾" Aluminum)

**5**

**BRACKET KITS**

All Finyl Line rail kits include brackets. Brackets also sold separately including swivel brackets for T-Top rails and bracket adapters.

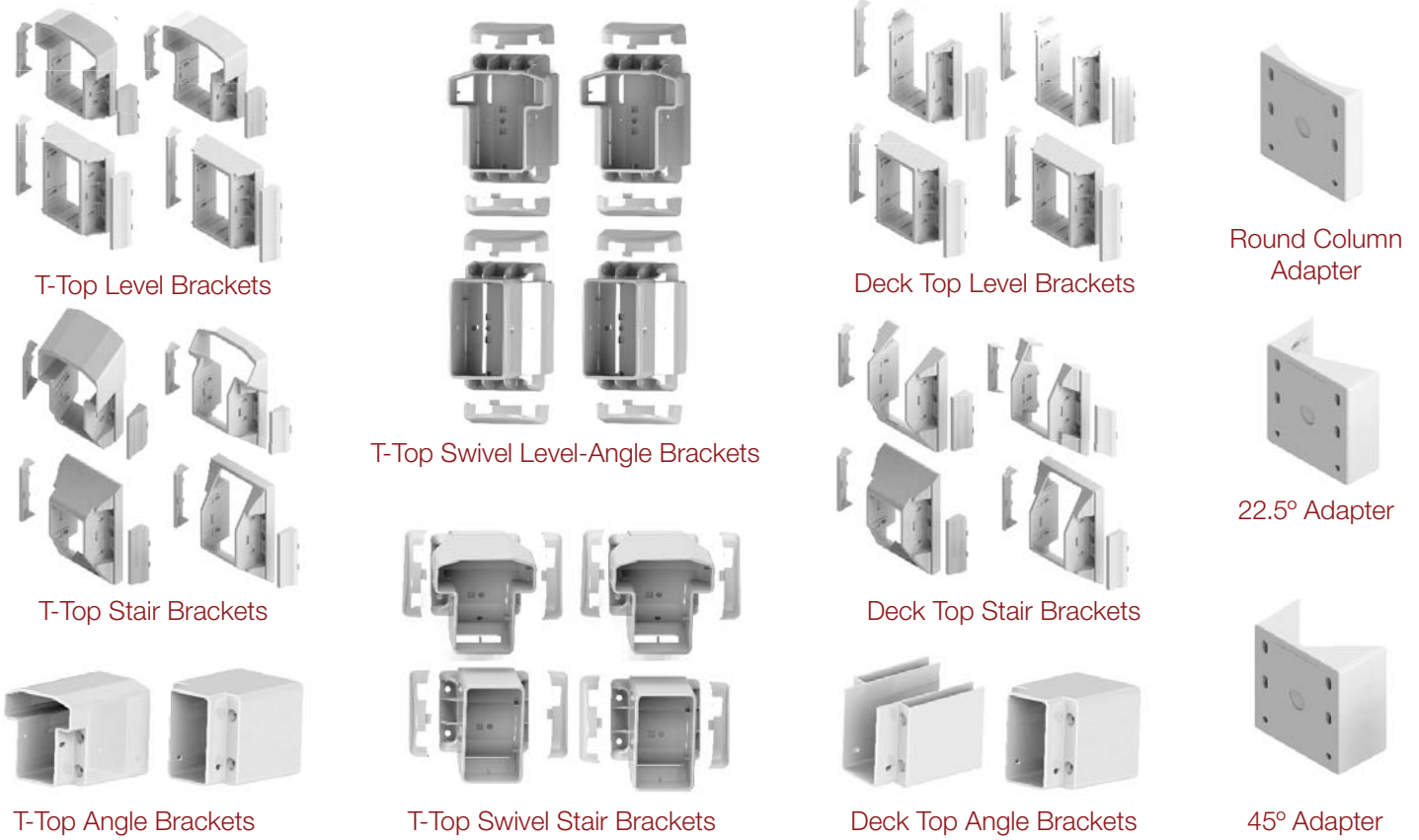

**6**

**CHOOSE YOUR GATE KIT**

Standard gate kits (36" wide opening) are available in 2 heights to work with 36" and 42" railing and are compatible with all vinyl rail systems. Custom gates available in 36" and 42" finished heights and cannot exceed 48" in width. Gate hardware sold separately.



**7**

**CHOOSE YOUR LIGHTING OPTIONS**

In addition to solar and LED post caps, our under-rail lighting gives a unique look and creates ambiance for your deck. Installs quickly and easily with our new plug and play wiring system, and attaches securely with its strong adhesive backing. Simply install the light strip into the light channel and use the supplied adhesive to adhere to your top rail. See page 86 for all the lighting options.



# SKU LIST

## 1 FINYL LINE T-TOP – 1½" SQUARE BALUSTER RAIL KITS – 36" HEIGHT

DESCRIPTION	WHITE	WHITE*	EARTH	DUNE
4' x 36" H – Level Rail Kit	73019536	73019688	N/A	N/A
5' x 36" H – Level Rail Kit	73019560	73019689	N/A	N/A
6' x 36" H – Level Rail Kit	73019603	73019690	73019587	73041503
8' x 36" H – Level Rail Kit	73019652	73019691	73019636	73041563
10' x 36" H – Level Rail Kit	73019517	73019687	73019510	73041504
6' x 36" H – 28°-38° Stair Rail Kit	73019599	73019600	73019593	73041505
8' x 36" H – 28°-38° Stair Rail Kit	73019648	73019649	73019642	73041506
10' x 36" H – 28°-38° Stair Rail Kit	73019515	N/A	N/A	N/A

\*Packed in clear see-through shrink "toughpack"; all other kits boxed.

## 1 FINYL LINE T-TOP – 1½" SQUARE BALUSTER RAIL KITS – 42" HEIGHT

DESCRIPTION	WHITE	EARTH	DUNE
4' x 42" H – Level Rail Kit	73019543	N/A	N/A
5' x 42" H – Level Rail Kit	73019567	N/A	N/A
6' x 42" H – Level Rail Kit	73019616	73019611	73041509
8' x 42" H – Level Rail Kit	73019665	73019660	73041510
6' x 42" H – 28°-38° Stair Rail Kit	73019615	N/A	N/A
8' x 42" H – 28°-38° Stair Rail Kit	73019664	73019662	73041512

## 1 FINYL LINE T-TOP – 1½" TURNED BALUSTER RAIL KITS – 36" HEIGHT

DESCRIPTION	WHITE	EARTH	SAHARA
4' x 36" H – Level Rail Kit	73019537	N/A	N/A
6' x 36" H – Level Rail Kit	73019604	73019588	73041515
8' x 36" H – Level Rail Kit	73019653	73019637	73041516
10' x 36" H – Level Rail Kit	73019519	73019511	73041517
6' x 36" H – 28°-38° Stair Rail Kit	73019601	N/A	N/A
8' x 36" H – 28°-38° Stair Rail Kit	73019650	73019643	73041519



## 1 FINYL LINE T-TOP – ¾" ROUND ALUMINUM BALUSTER RAIL KITS – 36" HEIGHT

DESCRIPTION	WHITE	EARTH	DUNE
4' x 36" H – Level Rail Kit	73019535	N/A	N/A
6' x 36" H – Level Rail Kit	73019602	73019586	73041522
8' x 36" H – Level Rail Kit	73019651	73019635	73041523
10' x 36" H – Level Rail Kit	73019516	73019509	73041524
6' x 36" H – 28°-38° Stair Rail Kit	73019598	N/A	N/A
8' x 36" H – 28°-38° Stair Rail Kit	73019647	73019641	73041526

## 1 FINYL LINE DECK TOP – 1½" SQUARE BALUSTER RAIL KITS – 36" HEIGHT

DESCRIPTION	WHITE	EARTH	DUNE
6' x 36" H – Level Rail Kit	73019584	73019569	73041529
8' x 36" H – Level Rail Kit	73019633	73019618	73041530
10' x 36" H – Level Rail Kit	73019518	N/A	N/A
6' x 36" H – 28°-38° Stair Rail Kit	73019581	N/A	N/A
8' x 36" H – 28°-38° Stair Rail Kit	73019630	73019624	73041533

## 1 FINYL LINE DECK TOP – 1½" SQUARE BALUSTER RAIL KITS – 42" HEIGHT

DESCRIPTION	WHITE	EARTH	DUNE
6' x 42" H – Level Rail Kit	73019610	73019605	73041536
8' x 42" H – Level Rail Kit	73019659	73019654	73041537
8' x 42" H – 28°-38° Stair Rail Kit	73019658	73019656	73041539

INCLUDED IN KITS	4' LEVEL	5' LEVEL	6' LEVEL	8' LEVEL	10' LEVEL	6' STAIR	8' STAIR
1½" Balusters (Square/turned)	9	11	13	18	20	12	16
¾" Balusters (Round aluminum)	10	13	15	20	26	12	17
Top Vinyl Rail	1	1	1	1	1	1	1
Top Aluminum Stiffener	1	1	1	1	1	1	1
Bottom Vinyl Rail	1	1	1	1	1	1	1
Bottom Aluminum Stiffener	1	1	1	1	1	1	1
Bracket Kit (2 top, 2 bottom)	1	1	1	1	1	1	1
Support Foot	N/A	N/A	N/A	N/A	1	N/A	N/A

# SKU LIST

## 1 FINYL LINE DECK TOP – 1½" TURNED BALUSTER RAIL KITS – 36" HEIGHT

DESCRIPTION	WHITE	EARTH	DUNE
6' x 36" H – Level Rail Kit	73019585	73019570	73041542
8' x 36" H – Level Rail Kit	73019634	73019619	73041543
10' x 36" H – Level Rail Kit	73019508	N/A	N/A
6' x 36" H – 28°-38° Stair Rail Kit	73019582	N/A	N/A
8' x 36" H – 28°-38° Stair Rail Kit	73019631	73019625	73041546

## 1 FINYL LINE DECK TOP – ¾" ROUND ALUMINUM BALUSTER RAIL KITS – 36" HEIGHT

DESCRIPTION	WHITE	EARTH	DUNE
6' x 36" H – Level Rail Kit	73019583	73019568	73041549
8' x 36" H – Level Rail Kit	73019632	73019617	73041550
10' x 36" H – Level Rail Kit	73019507	N/A	N/A
6' x 36" H – 28°-38° Stair Rail Kit	73019580	N/A	N/A
8' x 36" H – 28°-38° Stair Rail Kit	73019629	73019623	73041553

INCLUDED IN KITS	6' LEVEL	8' LEVEL	10' LEVEL	6' STAIR	8' STAIR
1½" Balusters (Square/turned)	13	18	20	12	16
¾" Balusters (Round aluminum)	15	20	26	12	17
Top Vinyl Rail	1	1	1	1	1
Top Aluminum Stiffener	1	1	1	1	1
Bottom Vinyl Rail	1	1	1	1	1
Bottom Aluminum Stiffener	1	1	1	1	1
Bracket Kit (2 top, 2 bottom)	1	1	1	1	1
Support Foot	N/A	N/A	1	N/A	N/A

## 2 FINYL LINE T-TOP BRACKET KITS

DESCRIPTION	WHITE	EARTH	DUNE
Level Bracket Set (2 top & 2 bottom brackets)	73019685	73019681	73041560
Stair Bracket Set (2 top & 2 bottom brackets)	73019686	73019682	73041561
Angle Bracket Set (1 pair – cut to desired angle)	73021923	73021924	73041562
Swivel Level-Angle Bracket Set (2 top & 2 bottom brackets)	73018805	N/A	N/A
Swivel Stair Bracket Set (2 top & 2 bottom brackets)	73018804	N/A	N/A

## 2 FINYL LINE DECK TOP BRACKET KITS

DESCRIPTION	WHITE	EARTH	DUNE
Level Bracket Set (2 top & 2 bottom brackets)	73019670	73019666	73041554
Stair Bracket Set (2 top & 2 bottom brackets)	73019671	73019667	73041555
Angle Bracket Set (1 pair – cut to desired angle)	73021926	73021927	73041556

## 2 FINYL LINE COLUMN & ANGLE ADAPTERS

DESCRIPTION	WHITE	EARTH	DUNE
8" Round Column Adapter (2 pack)	73019680	73019674	73041557
45° Angle Adapter (1 top & 1 bottom brackets)	73019679	73019673	73041558
22.5° Angle Adapter (1 top & 1 bottom brackets)	73019678	73019672	73041559

# VINYL CLAD ALUMINUM





**Titan Pro Rail** was created with the installer in mind. A Titan rail section assembles in minutes and is ideal for residential and commercial applications. Metal-to-metal connections add to the sound engineering that enables easy and safe installations. Titan vinyl-clad aluminum railing is manufactured using the highest quality materials to meet your performance and building requirements.



# FEATURE SPOTLIGHT

1



1

## TOP RAIL PROFILE

The top rail profile is designed to meet the International Residential Code for stair rail graspability\* – no secondary hand rail needed in non-continuous applications!

2

## PRE-ASSEMBLED POST

Extremely strong, heavy duty 3.15" x 3.15" square galvanized interior post extends above the top brackets, providing a metal to metal connection between the brackets and posts. Posts have a 1/4" x 5" x 5" square flange plate welded to the upright and are hot-dip galvanized. Flange posts can be mounted to almost any surface.

3

## PRE-INSTALLED BRACKETS

Pre-attached brackets save valuable installation time and ensure consistent code-compliant bottom spacing and finished rail height. Titan Pro End, Mid, and Corner posts are supplied pre-assembled for 36" or 42" high railing applications. The blank post can be utilized in both stair and level applications if the pre-assembled post is not ideal. For stair applications using the blank post, our no-cut stair brackets make installation easy, saving you time!

*\*The Titan Pro Rail System exceeds U.S. building code requirements. Always consult your local Building Code Department for applicable regulations and product acceptance. For additional information on Titan Pro Rail or other RDI products visit [www.rdirail.com](http://www.rdirail.com) or contact our Customer Service Department at (877) 420-7245.*



2



3



# HOW TO ORDER

## 1 CHOOSE A POST

Titan Pro posts are available in white only. For installations using our Earth color options, select your post sleeves and accessories in the color of your choice in Step 4 from our Crossover Product selection (page 84).



Blank Posts



Mid Posts

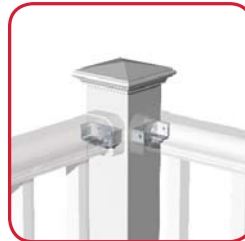

Corner Posts



End Posts

Post kits include steel post insert, vinyl sleeve, brackets with covers (except blank posts), trim ring, and two vinyl shims. Titan Posts with sleeve are 3.4" x 3.4" square and bottom brackets are set for a 2" bottom space.

## 2 CHOOSE A POST CAP

Titan Post Caps are designed to fit on Titan posts.



Decorative Cap



Flat Cap

## 3 CROSSOVER PRODUCT POST OPTIONS

If you're installing Titan Pro using existing 4" x 4" or 6" x 6" wood posts, choose your level & stair sections (step 4), & then purchase a bracket set for each rail section (see step 5). Finally, choose your finishing touches from our **CROSSOVER PRODUCT** (page 84).

### a CHOOSE A POST SLEEVE



### b CHOOSE A TRIM RING\*

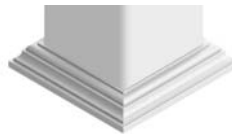

*\*Only the Low Profile or 4-piece Adjustable trim ring provide sufficient clearance for Titan bottom brackets*

### c CHOOSE A POST CAP

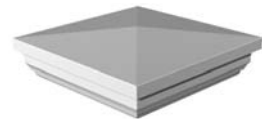

## 4 CHOOSE YOUR LEVEL AND STAIR SECTIONS

Titan kits available with 1 1/4" square balusters. Brackets for each section need to be purchased separately if not using a Titan post. Available for a 36" finished height (with 2" bottom space) and available in 42" commercial height (with 2" bottom space).

### Level Kits

6'  
8'  
10'

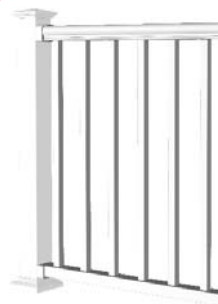

### Stair Kits

6'  
8'





### 5

#### BRACKET KITS

Titan Pro posts come with pre-attached level brackets on all but blank posts. If using Titan blank posts (for stair or level) or non-Titan posts, bracket kits must be purchased separately.



Level Bracket Kit



Stair Bracket Kit

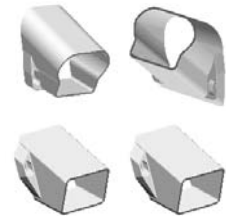

No-Cut Stair Bracket Kit



45° Bracket Adapter



22.5° Bracket Adapter



Round Column Adapter

### 6

#### CHOOSE YOUR GATE KIT

Standard gate kits (36" wide opening) are available in 2 heights to work with 36" and 42" railing and are compatible with all vinyl rail systems. Custom gates available in 36" and 42" finished heights and cannot exceed 48" in width. Gate hardware sold separately.



### 7

#### CHOOSE YOUR LIGHTING OPTIONS

In addition to solar and LED post caps, our under-rail lighting gives a unique look and creates ambiance for your deck. Installs quickly and easily with our new plug and play wiring system, and attaches securely with its strong adhesive backing. Simply install the light strip into the light channel and use the supplied adhesive to adhere to your top rail. See page 86 for all the lighting options.



# SKU LIST

## 1 TITAN PRO RAIL – POST KITS – with 2" BOTTOM SPACE

DESCRIPTION	WHITE
3.4" x 3.4" x 38.125" Blank Post Assembly for 36" Railing Height	73018657
3.4" x 3.4" x 38.125" End-Post Assembly for 36" Railing Height	73018662
3.4" x 3.4" x 38.125" Mid-Post Assembly for 36" Railing Height	73018664
3.4" x 3.4" x 38.125" Corner Post Assembly for 36" Railing Height	73018660
3.4" x 3.4" x 44.125" Blank Post Assembly for 42" Railing Height	73018658
3.4" x 3.4" x 44.125" End-Post Assembly for 42" Railing Height	73018663
3.4" x 3.4" x 44.125" Mid-Post Assembly for 42" Railing Height	73018665
3.4" x 3.4" x 44.125" Corner Post Assembly for 42" Railing Height	73018661
3.4" x 3.4" x 50.125" Blank Post Assembly for 42" Railing Height – (For stairs)	73018659

Post kits include steel post insert, vinyl sleeve, brackets with covers (except blank posts), trim ring, and two vinyl shims.

## 2 TITAN PRO RAIL – ACCESSORIES

DESCRIPTION	WHITE
Flat Post Cap	73018242
Decorative Post Cap	73018240

Titan post caps are designed to fit Titan posts only.

## 3 TITAN PRO RAIL – RAIL KITS – 1 ¼" SQUARE BALUSTER

DESCRIPTION	WHITE	EARTH
6' x 36" H – Level Rail Kit	73018163	73018165
8' x 36" H – Level Rail Kit	73018012	73018171
10' x 36" H – Level Rail Kit	73018157	73018159
6' x 36" H – 32° – 38° Stair Rail Kit	73018200	73018202
8' x 36" H – 32° – 38° Stair Rail Kit	73018207	N/A
6' x 42" H – Level Rail Kit	73018167	73018168
8' x 42" H – Level Rail Kit	73018173	73018174
10' x 42" H – Level Rail Kit	73018161	73018162
6' x 42" H – 32° – 38° Stair Rail Kit	73018204	73018205
8' x 42" H – 32° – 38° Stair Rail Kit	73018211	N/A

Brackets not included in rail kits. Titan posts come with pre-attached brackets for ease of install for level applications; if not using Titan posts, level brackets must be purchased separately from your rail kit. Stair brackets sold separately.

INCLUDED IN KITS	6' LEVEL	8' LEVEL	10' LEVEL	6' STAIR	8' STAIR
1¼" Square Balusters	14	19	24	11	15
Top Vinyl Rail	1	1	1	1	1
Top Aluminum Stiffener	1	1	1	1	1
Bottom Vinyl Rail	1	1	1	1	1
Bottom Aluminum Stiffener	1	1	1	1	1
Support Foot	1	1	1	0	0

**4** For other post options (including 4" x 4", 6" x 6", and structural posts) and additional accessories if not using a Titan post, see our Crossover Product section on page 84.

**5 TITAN PRO RAIL – BRACKET ACCESSORIES**

DESCRIPTION	WHITE	EARTH
Level Bracket Kit – 2 Pair	73018011	73018228
Stair Bracket Kit – 2 Pair	73018229	73018232
No-Cut Stair Bracket Kit – 2 Pair	73018230	73018231
45° Bracket Adapter Kit – 1 Pair	73018225	73018226
22.5° Bracket Adapter Kit – 1 Pair	73018223	73018224
Round Column Adapter Kit – 1 Pair	73018251	N/A
Level Bracket Attachment Jig (No color)	73018227	

**6** For gate options, see our Crossover Gates on page 87.

**7** To see all the LED lighting options and details, see our Crossover LED Lighting on page 86.

# ADA HAND RAIL



**VINYL HAND RAIL™** is an ADA compliant\* graspable hand rail that provides added safety and security to any stair or ramp. The key to its success is its simplicity; we've made the daunting task of installation easy with our step-by-step illustrated instructions and selection of versatile components. Vinyl clad aluminum Hand Rail features complete metal-to-metal connections for maximum strength. Our vinyl clad aluminum Hand Rail system can be joined in many different configurations to provide ADA compliant graspability on stairs or ramps.

*\*Always consult your local Building Code Department for applicable regulations and product acceptance.*

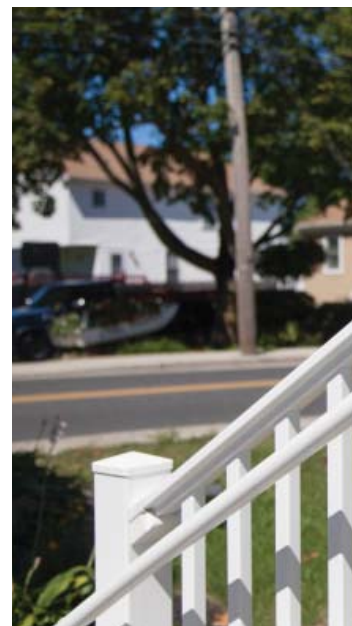
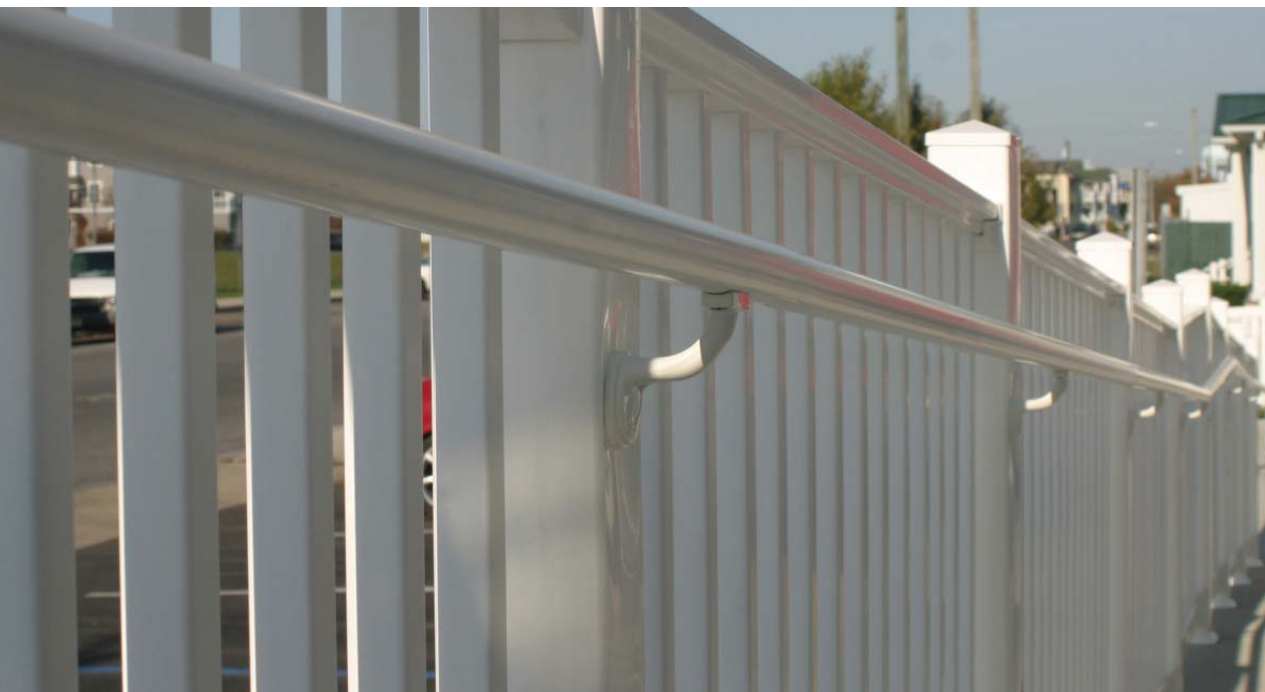

# VINYL HAND RAIL™

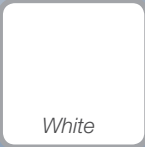

# VINYL HAND RAIL

## SELECT YOUR COMPONENTS

ADA Vinyl Hand Rail is a secondary hand rail to be installed in addition to a primary railing installation.

1

### LINEALS

ADA Vinyl Hand Rail lineals come in lengths of 80", 104" and 120".



Vinyl Clad Aluminum Hand Rail



180° Return Loop

2

### MOUNTING BRACKETS

Select from a variety of mounting options for your installation. A mounting bracket is required every 6' of Hand Rail lineal. Hardware to attach mounting brackets to lineals is included; hardware to attach to posts is not included.



Mounting Bracket



Inside Corner Mounting Bracket



90° Post Return



Straight Wall Return

3

### HAND RAIL JOINERS

A variety of Hand Rail joiners help create the exact layout for your ADA hand rail that you need.

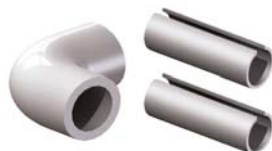

90° Corner



Adjustable Joiner

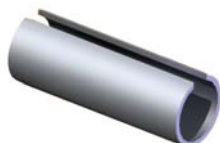

Straight Joiner

4

### HAND RAIL ACCESSORIES

Finish your project with joint ring to hide joins and end cap for a finished look on lineals.



Joint Ring



End Cap

# SKU LIST

## 1 VINYL HAND RAIL – LINEALS

DESCRIPTION	WHITE	EARTH	DUNE
120" Vinyl Clad Aluminum Hand Rail	73018380	73018808	73041384
104" Vinyl Clad Aluminum Hand Rail	73018377	73018806	73041385
80" Vinyl Clad Aluminum Hand Rail	73018381	73018810	73041386
180° Return Loop	73018392	73018818	73041387

## 2 VINYL HAND RAIL – MOUNTING BRACKETS

DESCRIPTION	WHITE	EARTH	DUNE
Mounting Bracket	73018384	73018812	73041388
Inside Corner Mounting Bracket	73018394	73018820	73041389
90° Post Return	73018398	73018824	73041390
Straight Wall Return	73018402	73018826	73041391

## 3 VINYL HAND RAIL – JOINERS

DESCRIPTION	WHITE	EARTH	DUNE
90° Corner	73018386	73018814	73041392
Internal Adjustable Joiner (No color)	73018382		
Internal Straight Joiner (No color)	73018399		

## 4 VINYL HAND RAIL – ACCESSORIES

DESCRIPTION	WHITE	EARTH	DUNE
Joint Ring	73018396	73018822	73041393
End Cap	73018390	73018816	73041394

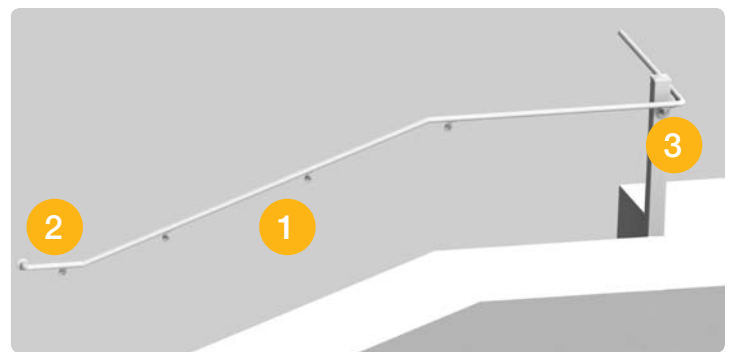
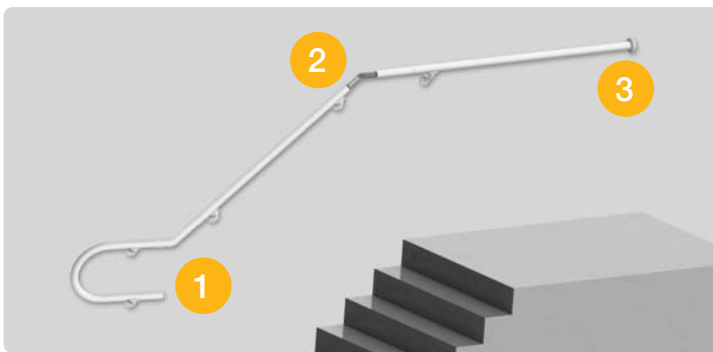

- 1 180° return loop returns the rail back past the post center line to meet ADA graspability requirements.
- 2 Our internal adjustable jointer allows you to create the angle you need from 0° to 90°.
- 3 Cast aluminum straight return terminates railing to any wall or post. Includes our unique snap-fit vinyl cover to conceal fasteners.

- 1 Internal joiners provide a continuous metal-to-metal connection for our Hand Rail lineals, and coupled with the joint ring, create a smooth, finished installation.
- 2 90° post return creates a termination at any post or wall.
- 3 90° corner creates a smooth corner where you need it, eliminating miter cuts.

Hardware to attach mounting brackets to surface not included.

# ADA HAND RAIL

**ALUMINUM HAND RAIL™** is the perfect solution for applications where durable, low-maintenance, graspable metal hand rail is desired. Strong, metal-to-metal connections ensure dependable safety and security for any stair or ramp that requires ADA code compliance.

*\*Always consult your local Building Code Department for applicable regulations and product acceptance.*





# ALUMINUM HAND RAIL™

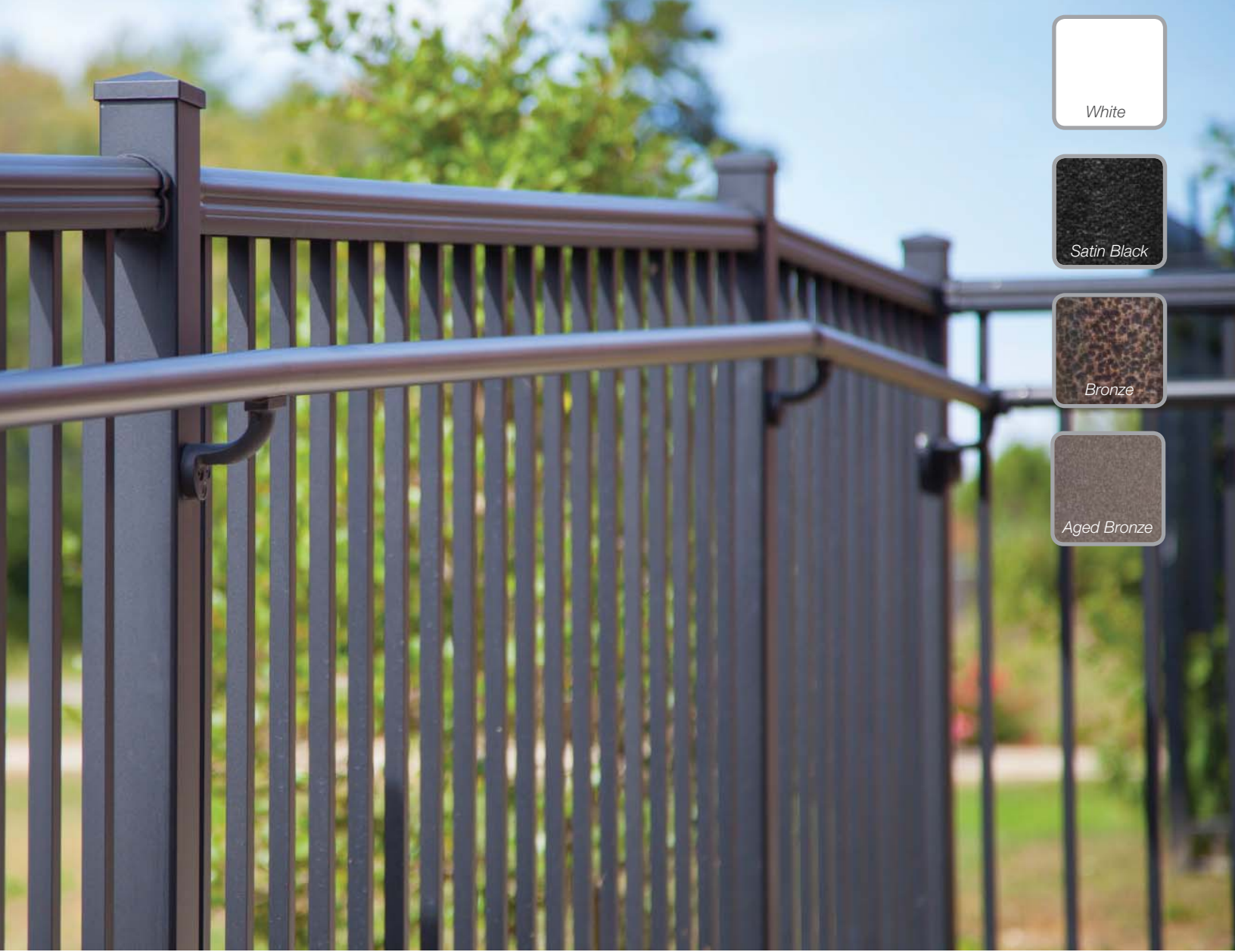

*White*



*Satin Black*

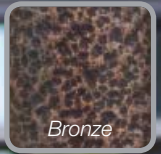

*Bronze*



*Aged Bronze*



# ALUMINUM HAND RAIL

## SELECT YOUR COMPONENTS

ADA Aluminum Hand Rail is a secondary hand rail to be installed in addition to a primary railing installation.

### 1 LINEALS

ADA Aluminum Hand Rail lineals come in lengths of 80", 104", and 120".



Aluminum Hand Rail



180° Return Loop

### 2 MOUNTING BRACKETS

Select from a variety of mounting options for your installation. A mounting bracket is required every 6' of Hand Rail lineal. Hardware to attach mounting brackets to steel or aluminum posts included and hardware for vinyl posts included in brackets indicating use for vinyl posts.



Mounting Bracket



Mounting Bracket for Vinyl Posts



Inside Corner Mounting Bracket



90° Post Return



90° Post Return for Vinyl Posts



Straight Wall Return

### 3 HAND RAIL JOINERS

Aluminum Hand Rail offers our unique external joiner for adjustable angles without miter cuts. You can also use our Vinyl Hand Rail internal straight joiner with the Aluminum Hand Rail System.



Aluminum Hand Rail Adjustable Joiner



Straight Joiner



90° Corner

### 4 HAND RAIL ACCESSORIES

The matching finish of our end cap and joint ring adds a finished look to your hand rail. Spacer Block is perfectly sized to help block out mounting brackets.



End Cap



Joint Ring



Spacer Block

# SKU LIST

## 1 ALUMINUM HAND RAIL – LINEALS

DESCRIPTION	WHITE	SATIN BLACK	BRONZE	AGED BRONZE
1.5" x 80" Aluminum Lineal	73019171	73019169	73019170	73041311
1.5" x 104" Aluminum Lineal	73019175	73019173	73019174	73041309
1.5" x 120" Aluminum Lineal	73019179	73019177	73019178	73041310
180° Return Loop	73019227	73019229	73019228	73041325

## 2 ALUMINUM HAND RAIL – MOUNTING BRACKETS

DESCRIPTION	WHITE	SATIN BLACK	BRONZE	AGED BRONZE
Mounting Bracket	73019151	73019149	73019150	73041323
Mounting Bracket for Vinyl Posts	N/A	73042847	N/A	N/A
Inside Corner Mounting Bracket	73041318	73041317	N/A	73041315
90° Post Return	73019147	73019145	73019146	73041324
90° Post Return for Vinyl Posts	N/A	73042848	N/A	N/A
Straight Wall Return	73019155	73019153	73019154	73041326

## 3 ALUMINUM HAND RAIL – JOINERS

DESCRIPTION	WHITE	SATIN BLACK	BRONZE	AGED BRONZE
External Adjustable Joiner	73019167	73019165	73019166	73041314
Internal Straight Joiner (No color)	73018399			
90° Corner	73019163	73019161	73019162	73041312

## 4 ALUMINUM HAND RAIL – ACCESSORIES

DESCRIPTION	WHITE	SATIN BLACK	BRONZE	AGED BRONZE
End Cap	73019159	73019157	73019158	73041313
Joint Ring	73041322	73041321	N/A	73041319
Spacer Block*	73041469	73042849	N/A	73043094

*Spacer Block is 1/4" thick and used to help block out brackets for narrower, 2" Over-the-Top in-line Avalon posts installed between standard 2.5" Avalon posts.*



Spacer Block shown in Satin Black mounted behind mounting bracket.



New Inside Corner Mounting Bracket is sized perfectly for aluminum posts.

# RAILING ACCESSORIES

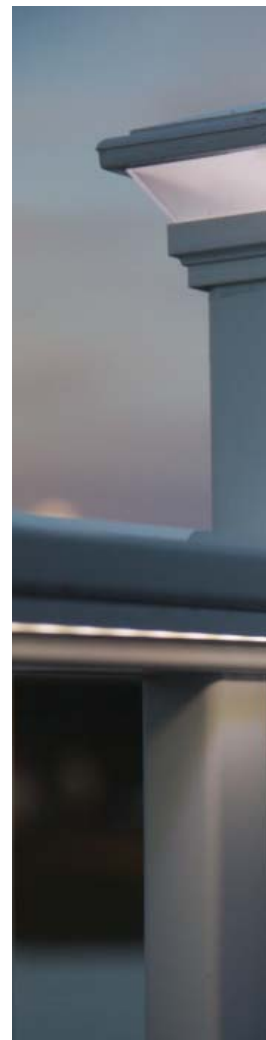

**CROSSOVER PRODUCT™** includes Post Sleeves and Wraps, Structural Posts, Porch Posts, Lighted Accessories, Gates, Post Caps and Trim Rings, all of which are compatible with Endurance, Finyl Line, Titan Pro Rail, Avalon Aluminum Railing and Metal Works Excalibur\* systems.

Decorative post caps and trim rings provide a finished look to your installation. Lighted accessories give you the option of either solar or LED post caps to add a bit of ambiance to your deck. Our versatile gate kits will complement any project.

*\*Excalibur and Avalon Aluminum Railing both include their own system of posts, but if you want a mix-and-match look, Crossover structural posts or 4" x 4" wooden posts (sleeved with vinyl post sleeves, Crossover aluminum sleeves, or Transform post sleeves) can be used with both systems. Excalibur and Avalon posts include a trim ring and post cap specifically sized for the posts for each system.*



crossover  

---

PRODUCT™



# LED LIGHTING

Easy plug-and-play installation!

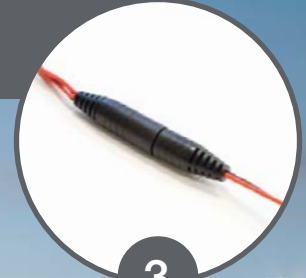
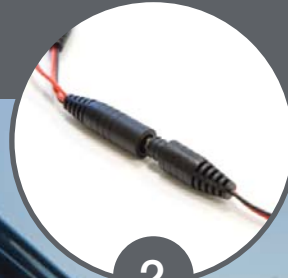
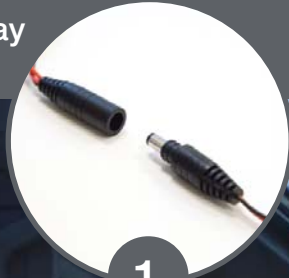

Bluetooth capable transformer can be controlled with your smartphone!

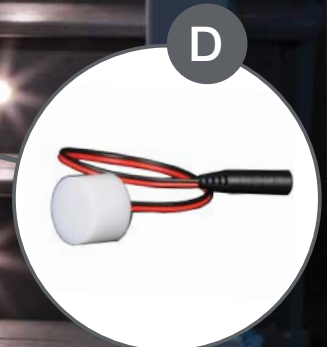
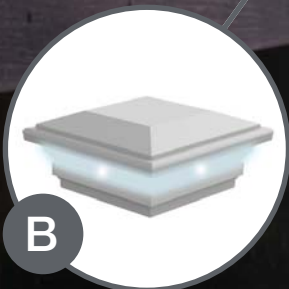

Original Rail shown with Under-Rail Lighting (A), Contemporary LED Post Cap (B), LED Dome Lights, (C) and LED Flush-Deck Lights (D).

# crossover PRODUCT™

We've made adding lighting to your deck easy! With our plug-and-play LED lighting system, there's no need for cutting and splicing wires. All splitters and harnesses connect with our LED accessories easily. Under-Rail light strips have an adhesive backing and come in lengths of 92". They can be adhered to the underside of your Transform or Avalon top rail. If using Finyl Line, Titan, or Original rail, the LED under-rail light strip is inserted into the under-rail light channel which is then adhered to the top rail using provided adhesive backing. LED lighted post caps are offered exclusively color matched and to fit Transform posts, Avalon posts, and Metal Works Excalibur posts. Additional Crossover LED accessories (post cap, dome light, side/stair light) in White can be used with Finyl Line, Titan Pro Rail, or Original Rail.



Under-Rail Lighting with Transform

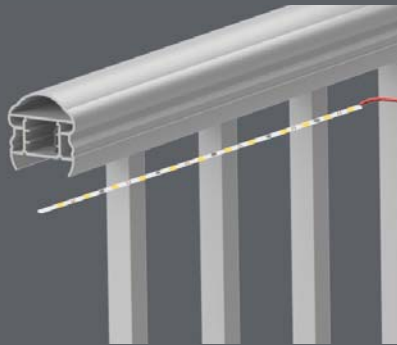

Under-Rail Lighting with Avalon



Under-Rail Lighting + channel with Original Rail

Transform LED Post Caps – page 23



Avalon LED Post Caps – page 33



# SELECTING POSTS

## 1 SELECT A POST (IF YOUR INSTALLATION REQUIRES A STRUCTURAL POST)

Structural posts come for finished railing heights of 36" and 42" heights in both flush mount and thru/fascia mount.

### 1a CHOOSE A STRUCTURAL POST

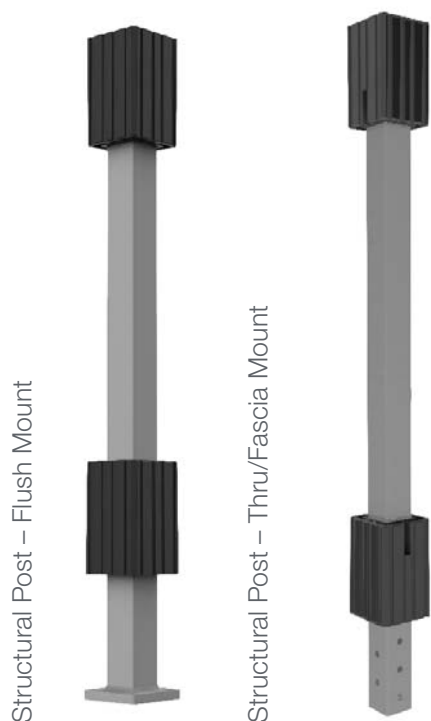

### 1b CHOOSE A POST SLEEVE

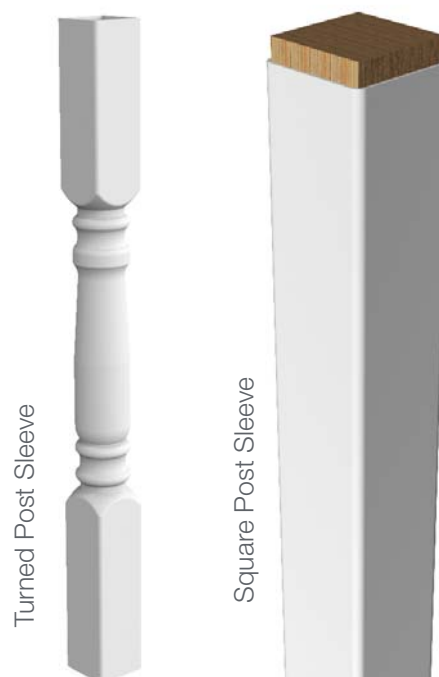

*Turned post sleeve must be used with a structural post.*

### 1b CHOOSE A POST WRAP TO GO OVER YOUR STRUCTURAL POST OR EXISTING 4" X 4" OR 6" X 6" POSTS!

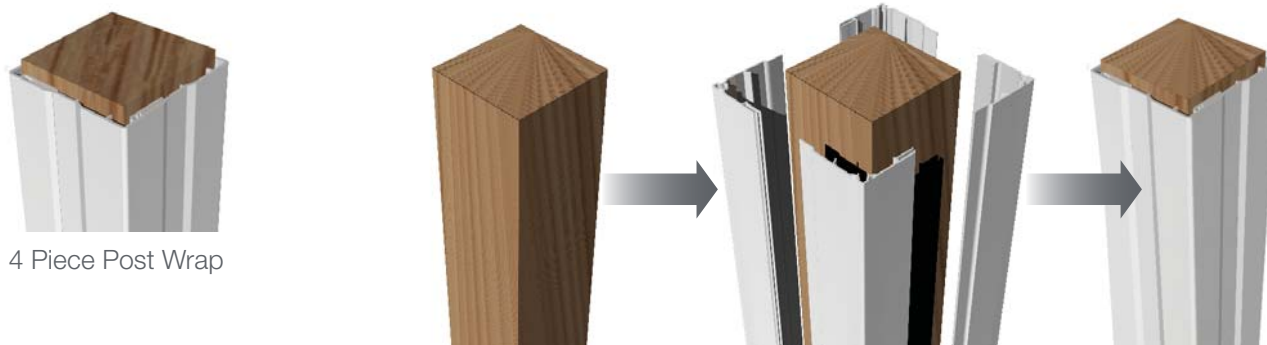

*Post Wraps are covered by US patent number D521,656S.*



## 2 SELECT A PORCH POST

### 2a PORCH POSTS (BASE MOUNTING KIT SOLD SEPARATELY)

Porch Posts come in heights of 108" and both 4" x 4" or 5" x 5" and load capacities of 2,500 lbs or 5,000 lbs.

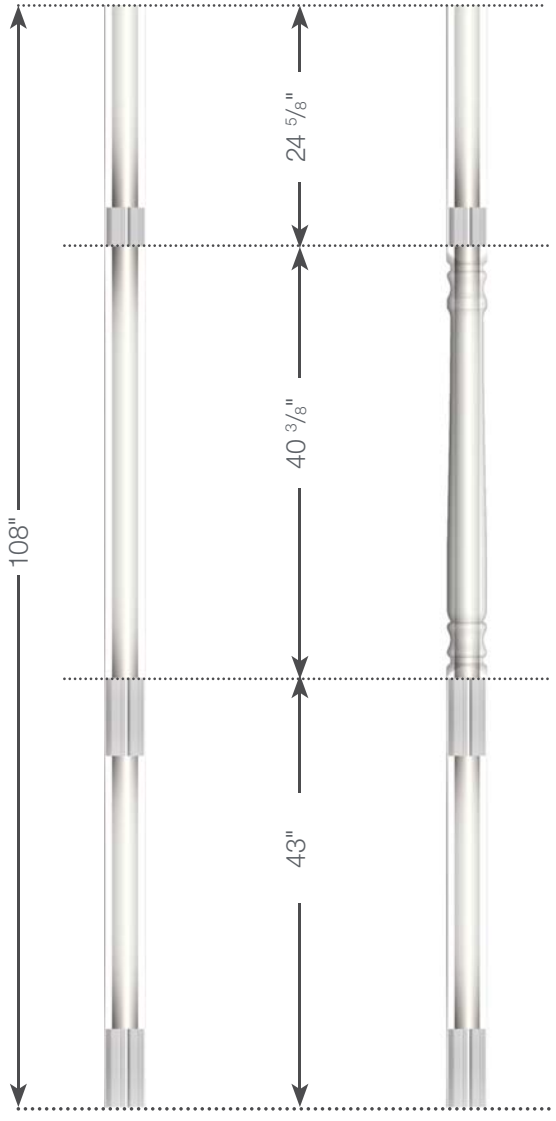

Square Post

Turned Post

### 2b CHOOSE A POST MOUNTING KIT (REQUIRED FOR PORCH POSTS)

Choose from the wind uplift base (prevents wind uplift up to 2,800 lbs) or standard base.

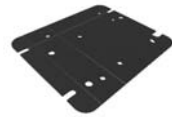
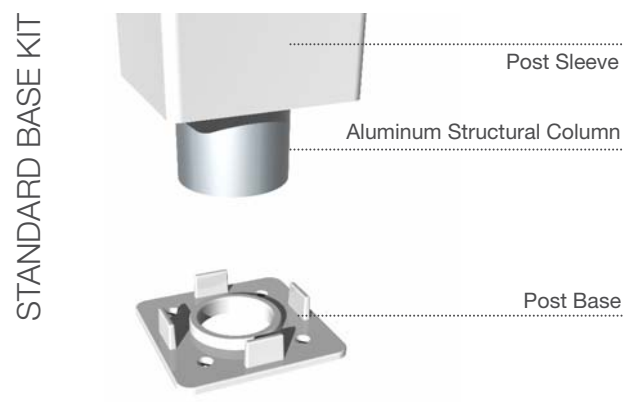

The PVC gasket prevents corrosion of the base plate and accommodates all Base Kits.

\*The Wind Uplift Kit Base is shown in black for illustration purposes only.

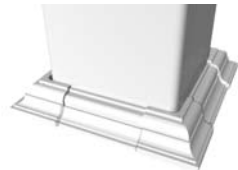

The adjustable Elite 4-Piece Trim Ring\*\* can be installed at any time and can be adjusted to fit posts from 3 1/2" x 3 1/2" to 6 1/2" x 6 1/2" without nails, screws or glue.

\*\*Required for Wind Uplift Base Kit.

# SELECTING ACCESSORIES

3

## CHOOSE YOUR POST CAPS

Choose from a selection of decorative post caps or for some ambience, choose a solar or low-voltage post cap!

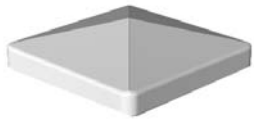

Flat Post Cap

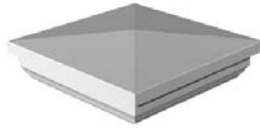

New England Post Cap



4" Elite Post Cap



6" Elite Post Cap



Heritage Post Cap



Contemporary Post Cap

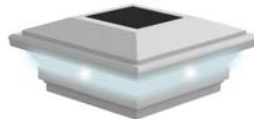

Contemporary Solar Post Cap



Kindle Solar Light Post Cap

4

## CHOOSE YOUR WIRED LIGHTING ACCESSORIES

Select a transformer, wiring, splitters for use with our lighted post caps. Or increase the wow factor of your deck at night with under-rail lighting. To determine the amount of power needed, simply add up the wattage of all your LED accessories and if less than 50W, then one transformer is needed. If more than 50W, a second transformer will be needed to power all LED accessories.



Transformer (50W)  
with Bluetooth capability



2-Way Splitter



5-Way Splitter



Lighting wire - available  
in 2', 5', 7' or 9' lengths.



92" Under-Rail Light  
(3W)



Under-Rail Light Channel  
(92" length)



Contemporary LED  
Post Cap (0.80W)



Dome Light (0.80W)



Side/Stair Light (0.40W)



Flush Deck Light (0.40W)

5

## CHOOSE YOUR TRIM RINGS

For a finished look, install a post trim! Coordinate the style with your post cap for a look that fits your aesthetics.



Elite Post Trim Ring\*



New England Post Trim Ring

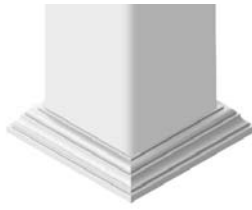

Low Profile Trim Ring\*

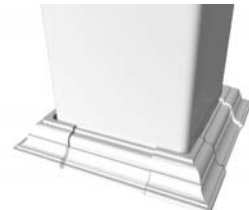

4-Piece Elite Trim Ring\*



Heritage Trim Ring

\*Allows for a 2" bottom space when used with Endurance Original Rail.

6

## CHOOSE YOUR GATE KIT

Standard gate kits (36" wide opening) are available in 2 heights to work with 36" and 42" railing and are compatible with all vinyl rail systems. Custom gates available in 36" and 42" finished heights and cannot exceed 48" in width. Gate hardware sold separately in white or black.



7

## CHOOSE YOUR GATE HARDWARE

Choose your gate hardware, available in black or white.



Standard Wrap Hinge Pair



GardDog™ Locking Latch 2-Sided



Gravity Latch



24" Drop Rod

## 1a CROSSOVER – STRUCTURAL POSTS

DESCRIPTION	
Structural Post for 36" Rail Height – Flush Mount	73019022
Structural Post for 36" Rail Height – Thru/Fascia Mount	73019023
Structural Post for 42" Rail Height – Flush Mount	73019024
Structural Post for 42" Rail Height – Thru/Fascia Mount	73019025

## 1b CROSSOVER – POST SLEEVES & POST WRAPS

DESCRIPTION	WHITE	EARTH	DUNE
4" x 4" x 39" Post Sleeve (Unit pack of 84)	61109087	61109644	73041475
4" x 4" x 39" Post Sleeve (Unit pack of 22)	73019260	N/A	N/A
4" x 4" x 45" Post Sleeve	61109088	61109645	73041476
4" x 4" x 54" Post Sleeve	73019029	N/A	N/A
4" x 4" x 100" Post Sleeve	73012479	N/A	N/A
4" x 4" x 108" Post Sleeve	61109090	61109647	73041477
4" x 4" x 120" Post Sleeve	73006803	N/A	N/A
4" x 4" x 48" Turned Post Sleeve (Requires structural post)	73018760	N/A	N/A
6" x 6" x 54" Post Sleeve	73018734	N/A	N/A
6" x 6" x 108" Post Sleeve	73018731	73018732	73041478
4" x 4" x 96" – 4 Piece Post Wrap*	73018473	73018474	73041479
4" x 4" x 120" – 4 Piece Post Wrap*	73018007	73018476	73041480
6" x 6" x 96" – 4 Piece Post wrap*	73018478	73018479	73041481
6" x 6" x 120" – 4 Piece Post Wrap*	73018008	73018481	73041482

\*4" x 4" Post Wrap can wrap a post from 3 3/8" square to 4 1/8" square and 6" x 6" Post Wrap can wrap a post from 5 7/16" square to 6 1/8" square.

# SKU LIST

## 2a CROSSOVER – PORCH POSTS (REQUIRES POST MOUNTING KIT)

DESCRIPTION	WHITE	EARTH	DUNE
4" x 4" x 108" Square Post – 2,500 lb. Capacity	73018767	N/A	N/A
4" x 4" x 108" Turned Post – 2,500 lb. Capacity	73018752	N/A	N/A
5" x 5" x 108" Turned Post – 5,000 lb. Capacity	73018010	73018741	73041483
5" x 5" x 108" Square Post – 5,000 lb. Capacity	73018769	N/A	N/A

## 2b CROSSOVER – POST MOUNTING KITS (REQUIRED FOR PORCH POSTS)

DESCRIPTION	
4" Standard Base Kit (Includes 1 bottom and 1 top mounting plate)	73018005
4" Wind Uplift Base Kit* (Includes 1 bottom, 1 top mounting plate, 2 pistons, and 2 PVC gaskets)	73018089
5" Standard Base Kit (Includes 1 bottom and 1 top mounting plate)	73018006
5" Wind Uplift Base Kit* (Includes 1 bottom, 1 top mounting plate, 2 pistons, and 2 PVC gaskets)	73018090

\*Wind uplift base kit prevents wind uplift up to 2,800 lbs.

## 3 CROSSOVER – POST CAPS

DESCRIPTION	WHITE	EARTH	DUNE
4" x 4" Flat Post Cap	73018076	73018074	73041484
4" x 4" New England Post Cap	73018079	73018077	73041486
6" x 6" New England Post Cap	73018108	73018106	73041489
4" x 4" Elite Post Cap	73018073	73018071	73041485
6" x 6" Elite Post Cap	73018105	N/A	N/A
4" x 4" Heritage Post Cap	73012500	N/A	N/A
4" x 4" Contemporary Post Cap	73019233	N/A	N/A
4" x 4" Contemporary Solar Post Cap	73019234	N/A	N/A
4" x 4" Kindle Solar Light Post Cap	73018059	73018469	73041487

## 4 CROSSOVER – LIGHTING OPTIONS

DESCRIPTION	
Bluetooth Transformer for LED Lighting System	73041277
2-Way Splitter	73019370
5-Way Splitter	73019371
2' Electrical Lighting Wire	73032449
5' Electrical Lighting Wire	73019375
7' Electrical Lighting Wire	73019373
9' Electrical Lighting Wire	73019374
92" Under Rail LED Lighting (3W for 92" length)	73019376
92" LED Light Channel (10 pack for use with Original Rail, Fynl Line, & Titan Pro Rail) – WHITE	73024866
4" x 4" Contemporary LED Post Cap (0.80W) – WHITE	73019377
Dome Light (0.80W) – WHITE	73019404
Stair/Side Light (0.40W) – WHITE	73019411
Flush Deck Light (0.40W)	73019403

Transformer is 50W and can be used with lighted post tops or under-rail lighting. Includes photocell, built-in dimmer, timer, and remote. Transformer is Bluetooth capable; "SmartPower50" app available in iTunes and Android store.

## 5 CROSSOVER – TRIM RINGS

DESCRIPTION	WHITE	EARTH	DUNE
4" x 4" Elite Post Trim Ring	73018091	73018092	73041490
4" x 4" New England Post Trim Ring	73018130	73018080	73041491
4" x 4" Heritage Post Trim Ring	73012503	N/A	N/A
4" x 4" Low Profile Trim Ring	73018083	73018082	73041492
3.5" to 6.5" – 4-Piece Elite Trim Ring	73018131	73018066	73041493

## 6 CROSSOVER – STANDARD WIDTH VINYL RAIL GATE KITS

DESCRIPTION	WHITE	EARTH	DUNE
Standard Width Gate Kit – 36" H – 1¼" Square Balusters	73018135	73018136	73041495
Standard Width Gate Kit – 36" H – 1¼" Turned Balusters	73018151	N/A	N/A
Standard Width Gate Kit – 36" H – ¾" Round Balusters	73032446	73032447	73041496
Standard Width Gate Kit – 42" H – 1¼" Square Balusters	73018132	73018133	73041497

## 6 CROSSOVER – CUSTOM WIDTH VINYL RAIL GATE KITS

DESCRIPTION	WHITE	EARTH	DUNE
Custom Width Gate Kit – 36" H – 1¼" Square Balusters	73018138	73018139	73041498
Custom Width Gate Kit – 36" H – 1¼" Turned Balusters	73018141	N/A	N/A
Custom Width Gate Kit – 36" H – ¾" Round Balusters	73018147	73018148	73041499
Custom Width Gate Kit – 42" H – 1¼" Square Balusters	73018144	73018145	73041500

Gate kits include everything to build a gate panel. Gate hardware sold separately.

## 7 BOERBOEL® VINYL GATE HARDWARE

DESCRIPTION	BLACK	WHITE
Boerboel® Standard Wrap Hinge Pair	73028117	73025512
Boerboel® GardDog™ Locking Latch Two Sided	73024418	73025501
Boerboel® Gravity Latch	73002252	73025491
Boerboel® 24" Heavy Duty Drop Rod	73014305	73014306

# OUTDOOR ACCENTS







**OUTDOOR ACCENTS** provide a complete system as a solution for under-deck screening as well as privacy screening on your porch.

**Decorative Screen Panels** provide privacy when hung from your deck or porch, or installed with our **Frame Kits**. Create a high-end unique look to under deck applications. Available in 6 styles and 6 colors, Decorative Screen Panels can also be painted for complete customization.

**Lattice** provides a traditional solution to under deck spaces with 3 patterns for varying degrees of screening and 9 color options.

For a finishing touch, our **Outdoor Shower Kits** offer an easy way to create a way to rinse off from the pool or beach in the privacy of your backyard with 4 easy to install options!



# FEATURE SPOTLIGHT



# OUTDOOR ACCENTS

1

## UNIQUE COMPOSITION

Durable textured matte finish and a 0.3" thickness make Decorative Screen Panels a sturdy yet elegant alternative to traditional lattice. And low thermal expansion and contraction ensure they stand up to all types of weather.

2

## FRAME KITS

Frame kits allow for panels to be installed up to 3 panels high, and posts can be used as end or mid posts for custom configurations. Durable powder-coated aluminum frames can be surface mounted, are easy to install, and come in Satin Black.

3

## NEW LIFETEXTURE™ DESIGNS

New Decorative Screen Panel designs Bungalow and Boardwalk feature LifeTexture – a 3D design with depth for added dimension

4

## DESIGN VERSATILITY

Decorative Screen Panels can be installed horizontally to finish the base of a deck, hung vertically for privacy in style, or installed with our new frame kits to create a privacy screen on your deck, porch, or patio!



# ORDER OPTIONS

1

## CHOOSE DECORATIVE SCREEN PANELS FRAME KITS

Decorative Screen Panel Frame Kits can hold 1-3 panels (sold separately) depending on your preference and are surface mounted. Powder coated aluminum frame assemblies quickly and easily to create your semi-privacy solution.



2

## CHOOSE DECORATIVE SCREEN PANELS

Decorative Screen Panels come in a variety of colors and designs. Install vertically or horizontally. Low thermal expansion and contraction, textured finish that's paintable, and 0.3" thick, Decorative Screen Panels are durable and unique.



Boardwalk\*

Bungalow\*

Celtic

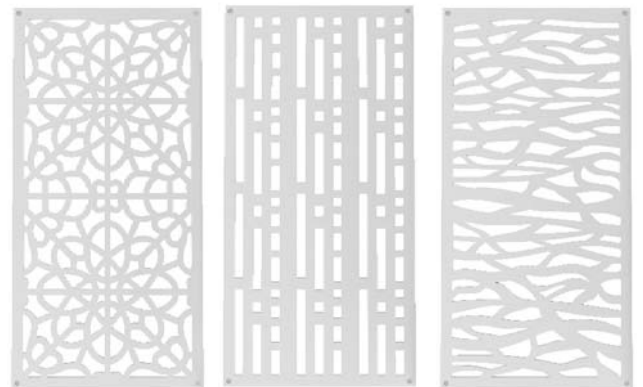

Fretwork

Morse

Sprig

\*Bungalow and Boardwalk designs feature new LifeTexture™ providing a subtle 3D look and feel for added depth and dimension.

3

## CHOOSE DECORATIVE SCREEN PANEL FASTENER KITS

Decorative Screen Panel Fastener kits include 12 stainless steel screws and 12 color matched screw covers – enough to install 3 panels when not using the Decorative Screen Panel Frame Kits. Fastener Kits are not needed if using a Decorative Screen Panel Frame Kit.



White



Clay



Greige



Saddle



Brazilian Walnut



Black

# OUTDOOR ACCENTS

3

## CHOOSE LATTICE ACCENTS

Lattice comes in a variety of colors and designs to accent and complement your outdoor living space!

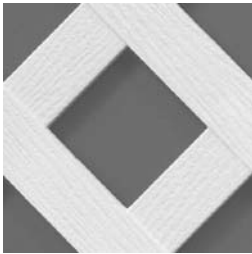

Classic Diamond

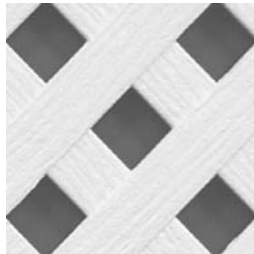

Privacy Diamond

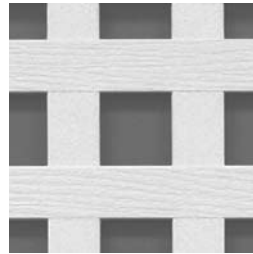

Privacy Square



Lattice Divider, Lattice Cap,  
Color Matched Screws



White



Woodland  
Green



Sierra  
Cedar



Redwood



Wicker



Brazilian  
Walnut



Nantucket  
Gray



Better Than  
Treated



Black

4

## CHOOSE AN OUTDOOR SHOWER KIT

Outdoor Shower Kits come in several options so you can create the custom configuration that fits your needs. Shower Kits are available in White and include Boerboel® hardware in Black (Combo Kit and Gate Door Kit).



Combo Kit

Includes 2 walls, 4 posts, 4 post tops, top towel rail bars, gate door, and hardware.



Enclosure Kit

Includes 2 walls, 4 posts, 4 post tops, top towel rail bars, and hardware.



Third Wall Kit

Includes boards, rails, and brackets to build out a wall to attach to a Combo Kit or Enclosure Kit.



Gate Door Kit

Includes boards, rails, and hardware to build out a gate door to attach to a Combo Kit or Enclosure Kit.

# SKU LIST

## 1 OUTDOOR ACCENTS – DECORATIVE SCREEN PANEL FRAME KIT

DESCRIPTION	SATIN BLACK
Frame Kit – Can hold 1-3 Decorative Screen Panels (Sold separately)	<b>73040779</b>

Decorative Screen Panels Frame Kits contain 2 2" aluminum H-posts, 2 top & bottom U-channels, 2 mid H-channels, 2 post inserts, surface mounting kit, post caps, and hardware.

## 2 OUTDOOR ACCENTS – DECORATIVE SCREEN PANELS

DESCRIPTION	BOARDWALK*	BUNGALOW*	CELTIC
4' x 2' x 0.3" – WHITE	<b>73042821</b>	<b>73042815</b>	<b>73004780</b>
4' x 2' x 0.3" – CLAY	<b>73042823</b>	<b>73042817</b>	<b>73004782</b>
4' x 2' x 0.3" – GREIGE	<b>73042825</b>	<b>73042819</b>	<b>73004784</b>
4' x 2' x 0.3" – SADDLE	<b>73042824</b>	<b>73042818</b>	<b>73004783</b>
4' x 2' x 0.3" – BRAZILIAN WALNUT	<b>73042826</b>	<b>73042820</b>	<b>73004685</b>
4' x 2' x 0.3" – BLACK	<b>73042822</b>	<b>73042816</b>	<b>73004781</b>
DESCRIPTION	FRETWORK	MORSE	SPRIG
4' x 2' x 0.3" – WHITE	<b>73004785</b>	<b>73004795</b>	<b>73004790</b>
4' x 2' x 0.3" – CLAY	<b>73004787</b>	<b>73004797</b>	<b>73004792</b>
4' x 2' x 0.3" – GREIGE	<b>73004789</b>	<b>73004799</b>	<b>73004794</b>
4' x 2' x 0.3" – SADDLE	<b>73004788</b>	<b>73004798</b>	<b>73004793</b>
4' x 2' x 0.3" – BRAZILIAN WALNUT	<b>73004686</b>	<b>73004688</b>	<b>73004687</b>
4' x 2' x 0.3" – BLACK	<b>73004786</b>	<b>73004796</b>	<b>73004791</b>

Decorative Screen Panels are designed with a matte, textured finish to allow them to be painted for complete customization.

\*Boardwalk and Bungalow designs feature new LifeTexture™, a subtle 3D look for added depth.

## 3 OUTDOOR ACCENTS – DECORATIVE SCREEN PANEL HARDWARE

DESCRIPTION	SKU
Fastener Kit (12 stainless steel screws & 12 color matched screw covers) – WHITE	<b>73025526</b>
Fastener Kit (12 stainless steel screws & 12 color matched screw covers) – CLAY	<b>73025528</b>
Fastener Kit (12 stainless steel screws & 12 color matched screw covers) – GREIGE	<b>73025530</b>
Fastener Kit (12 stainless steel screws & 12 color matched screw covers) – SADDLE	<b>73025529</b>
Fastener Kit (12 stainless steel screws & 12 color matched screw covers) – BRAZILIAN WALNUT	<b>73004820</b>
Fastener Kit (12 stainless steel screws & 12 color matched screw covers) – BLACK	<b>73025527</b>

# OUTDOOR ACCENTS

## 3 OUTDOOR ACCENTS – LATTICE

COLOR	CLASSIC DIAMOND (2' x 8')	CLASSIC DIAMOND (4' x 8')	PRIVACY DIAMOND (4' x 8')	PRIVACY SQUARE (4' x 8')
White	73004010	73004026	73004042	73004051
Woodland Green	N/A	73004020	73004037	N/A
Sierra Cedar	N/A	73004021	73004038	N/A
Redwood	N/A	73004023	73004040	N/A
Wicker	N/A	73003479	73003329	N/A
Brazilian Walnut	N/A	73004144	73004142	N/A
Nantucket Gray	N/A	73004145	73004143	N/A
Better Than Treated	N/A	73004027	73004108	N/A
Black	N/A	73004497	73004479	N/A

Lattice comes in a variety of color options and is NOT intended to be painted.

## 3 OUTDOOR ACCENTS – LATTICE ACCESSORIES

COLOR	CAP MOLDING	DIVIDERS	1 ½" SS SCREWS (12)
White	73004058	73004066	73003464
Woodland Green	73004057	73004079	73003466
Sierra Cedar	73004059	73004067	73003467
Redwood	73004061	73004069	73003470
Wicker	73003480	73003481	73003473
Brazilian Walnut	73004140	73004138	73003999
Nantucket Gray	73004141	73004139	73013281
Better Than Treated	73004064	73004081	73003472
Black	73004496	73004477	73014290

## 4 OUTDOOR ACCENTS – OUTDOOR SHOWER KITS

DESCRIPTION	WHITE
Shower Combo Kit (Includes 2 walls, 4 posts, 4 post caps, top rails, 1 gate, & hardware)	73040247
Shower Enclosure Kit (includes 2 walls, 4 posts, 4 posts caps, top rails & hardware)	73040248
Third Wall (Includes boards, rails, & hardware to assemble a third wall to use with Shower Kits)	73040244
Shower Door Gate Kit (Includes boards, rails, & hardware to assemble a gate door)	73040245



FOR HOME, FOR LIFE®

545 TILTON ROAD  
EGG HARBOR CITY, NJ 08215

TEL: (877) 420-7245  
FAX: (866) 277-5160  
E-MAIL: CS@RDIRAIL.COM  
URL: WWW.RDIRAIL.COM



*we're social!*

Follow us on our social media sites!



51012131  
REV. 09.18

