



Brutus

TILE FORCE

ROBERTS

PORTA-NAILS

Suspend-It
• DROP CEILING INSTALLATION •

**MASTER TOOL
CATALOG**



quality brands of



Q.E.P. Co., Inc., founded in 1979, is a world class, worldwide provider of innovative, quality and value-driven flooring and industrial solutions. As a leading worldwide manufacturer, marketer and distributor QEP delivers a comprehensive line of hardwood and engineered wood flooring, flooring installation tools, adhesives and flooring related products targeted for the PROFESSIONAL INSTALLER as well as the DO-IT-YOURSELFER. In addition the company provides industrial tools with cutting edge technology to all of the industrial trades.

The Company continues to build its reputation for offering its customers the most comprehensive flooring installation product line and wood flooring available from one company. The company markets over 5,000 products under various brand names that are well respected in their market niches. Brand names include QEP®, Roberts®, Capitol®, Harris Wood®, Brutus®, TileForce, Homelux, TileRite, PRCI, Nupla®, HISCO, Ludell, Porta-Nail and Elastiment®. Strategically located around the world, QEP currently has over 1,000,000 square feet of distribution and manufacturing capability located throughout the United States, Canada, Australia, New Zealand, United Kingdom, France and China.

QEP continually enhances its market leadership positions through selective acquisitions that extend its geographic reach, add proprietary product lines and broaden distribution capabilities, enabling the Company to capitalize on cross-selling opportunities. Additionally, the Company continues to develop and introduce innovative products and ideas for the professional installer in all target markets. Customer Service and Technical Support are key elements in this business and QEP prides itself on supplying the quality service that customers expect.



Brutus

TILE FORCE

ROBERTS

PORTA-NAILS

Suspend-It
• DROP CEILING INSTALLATION •

CONTENTS



TILE TOOLS

SAWS, DIAMOND BLADES, MIXERS, TILE CUTTERS, HAND TOOLS, KNEE PADS

04



CARPET TOOLS

STRETCHERS, KNEE KICKERS, HEAT BOND IRONS, HAND TOOLS, SHEARS

35



LAMINATE & WOOD TOOLS

FLOOR CUTTERS, HAND TOOLS, NAILERS, STAPLERS, CLEATS, STAPLES, PUTTY

53



VINYL TOOLS

ROLLERS, CUTTERS, HAND TOOLS

60



UNDERLAYMENTS & BARRIERS

LAMINATE, WOOD, LVT, VINYL, CARPET, TILE

64



MASONRY TOOLS

HAND TOOLS, BLADES, MOISTURE TEST KIT

69



TROWELS

TILE, VINYL, CARPET, WOOD

71



KNIVES, BLADES, SCREWS & NAILS

TILE, VINYL, CARPET, WOOD, BACKERBOARD, CEMENT BOARD

75



TAPE

TAPE, CARPET GRIPPER™

81



TEAR-OUT TOOLS

SCRAPERS, HAND TOOLS

84

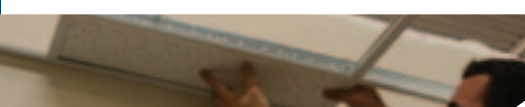

CEILING TOOLS

SUSPEND-IT®

89



TILE TOOLS

830Z 30" Professional Bridge Saw

QEP



- Ideal for cutting large format tile including ceramic, porcelain, granite, stone and marble tile
- Rips up to 30" tile and can diagonally cut up to 22" tile
- Adjustable pivoting rail for miter cuts and rip/angle cuts
- Plunging motor head for interior cutting
- One year limited warranty

SPECIFICATIONS

| | |
|----------------|---------------------------------------|
| Item No | 83230 |
| Motor | 1-1/2 HP / 120V-60Hz / 10.5 Amps |
| Watts | 1362 |
| RPM | 3260 |
| Blade Capacity | 8" |
| Arbor | 5/8" |
| Rip Cut | 30" Tile |
| Diagonal Cut | 22" Tile |
| Depth of Cut | 1-1/2" |
| Size | 46.3" L x 19.8" W x 57.5" H (w/stand) |
| Weight | 121.3 lbs (w/stand) |

ACCESSORIES INCLUDED

- 8" Black Widow™ diamond blade (6-8008BW)
- Fold-out stand with wheels
- High volume water pump (#60098)
- Laser cutting guide
- Side extension table
- Angle cutting guide
- Slide out handle and extra wheels
- 2 wrenches



24" Bridge Saw

QEP



- Direct drive 1-1/2 HP, 3550 RPM brushless motor is ideal for cutting marble, granite, porcelain, stone and tile*
- Rips up to a 24" tile and can diagonally cut a 18" tile
- Adjustable pivoting rail allows easy angle positioning from 90° to 45° for fast and consistent miter cuts
- One year limited warranty

* for porcelain and hard tiles, we recommend QEP's Black Widow (#6-8008BW)

SPECIFICATIONS

| | |
|----------------|-----------------------------------|
| Item No | 83200 |
| Motor | 1-1/2 HP / 120V-60Hz / 9.2 Amps |
| Watts | 1100 |
| RPM | 3550 |
| Blade Capacity | 8" |
| Arbor | 5/8" |
| Rip Cut | 24" Tile |
| Diagonal Cut | 18" Tile |
| Depth of Cut | 1-1/2" |
| Size | 37" L x 18" W x 47.5" H (w/stand) |
| Weight | 82.32 lbs (w/stand) |

ACCESSORIES INCLUDED

- Fold-out stand with wheel attachments
- Rear wheel attachments (#63036)
- Convenient storage shelf
- 8" continuous rim wet diamond blade for porcelain (#6-8003Q)
- High volume water pump (#60098)
- Laser cutting guide
- Angle/rip cutting guide
- Handles



900XT 10" Professional Tile Saw

QEP



- Ideal for cutting large format tile including ceramic, porcelain, granite, stone and marble tile
- Rips up to a 24" tile and can diagonally cut a 18" tile
- Adjustable plunging and pivoting motor head for interior cutting, miter cuts and rip/angle cuts
- One year limited warranty

SPECIFICATIONS

| | |
|----------------|--|
| Item No | 61900Q |
| Motor | 2.25 HP / 120V-60Hz / 15 Amps |
| Watts | 1750 |
| RPM | 3600 |
| Blade Capacity | 10" |
| Arbor | 5/8" |
| Rip Cut | 24" Tile |
| Diagonal Cut | 18" Tile |
| Depth of Cut | 3-3/4" |
| Size | 53.54" L x 33.07" W x 47.24" H (w/stand) |
| Weight | 101.39 lbs (w/stand) |

ACCESSORIES INCLUDED

- Premium Porcelain Rated 10" blade
- Fold-out stand with heavy duty wheels
- High volume water pump (#61900Q-31)
- Laser cutting guide & LED work area light
- Side extension table
- Full coverage splash guard water containment system
- Rip/Angle cutting guide
- 2 wrenches



24" Professional Tile Saw

BRUTUS



- Powerful 3450 RPM motor cuts the toughest marble, granite, stone, porcelain & masonry products, as well as all types of tile*
- Rips up to a 24" tile and can diagonally cut a 18" tile
- Adjustable tilting head offers quick and easy 45° to 90° miter cuts
- Plunge cutting for interior cut out of tile
- One year limited warranty

* for porcelain and hard tiles, we recommend QEP's Black Widow Blade (#6-1008BW)

SPECIFICATIONS

| | |
|----------------|-------------------------------------|
| Item No | 61024 |
| Motor | 1-1/2 HP / 120 V ~ 60 Hz / 9.5 Amps |
| Watts | 1100 |
| RPM | 3450 |
| Blade Capacity | 10" |
| Arbor | 5/8" |
| Rip Cut | 24" Tile |
| Diagonal Cut | 18" Tile |
| Depth of Cut | 2-3/8" |
| Size | 40" L x 21.5" W x 48.3" H (w/stand) |
| Weight | 105.8 lbs. (w/stand) |

ACCESSORIES INCLUDED

- Easy fold-out stand with 3" wheels
- 10" continuous rim wet diamond blade (6-1003Q)
- High volume water pump (#60095)
- Side table pull-out extension
- 45° - 90° angle/rip guide
- Rear water tray
- 2 wrenches



24" Heavy Duty Tile Saw

QEP



- Dual-speed 2 HP, 1750/2450 RPM motor cuts the toughest marble, granite, stone, porcelain & masonry products, as well as all types of tile*
- Rips up to a 24" tile and can diagonally cut a 14" tile
- Angle/rip guide and miter block make production cuts fast and consistent
- One year limited warranty

* for porcelain and hard tiles, we recommend QEP's Black Widow (#6-8008BW)

SPECIFICATIONS

| | |
|----------------|--|
| Item No | 60020SQ |
| Motor | 2 HP / 120 V ~ 60 Hz / 15 Amps |
| Watts | 1500 |
| RPM | 1750 / 2450 (dual speed) |
| Blade Capacity | 10" |
| Arbor | 5/8" |
| Rip Cut | 20" Tile (center) or 24" Tile (10" wide) |
| Diagonal Cut | 14" Tile |
| Depth of Cut | 3-1/4" |
| Size | 40" L x 22" W x 47" H (w/stand) |
| Weight | 116 lbs. (w/stand) |

ACCESSORIES INCLUDED

- Folding stand
- 10" continuous rim wet diamond blade (#6-1003Q)
- High volume water pump (#60095)
- 45° miter block
- 45° - 90° Angle/rip guide
- Wrenches and two hex keys



7" Professional Tile Saw

QEP



- Direct-drive, 1HP motor is surprisingly quiet but delivers enough power to handle ceramic, slate, marble, granite and porcelain*
- Large die-cast aluminum cutting table for support of large tiles
- Tilt-up cutting table for precision 15°, 30° and 45° miter cuts
- Adjustable rip and sliding angle guides for accurate production cuts
- Large blade cooling water reservoir reduces refills
- Portable for work in small spaces, handle for easy transport

* for porcelain and hard tiles, we recommend QEP's Black Widow Blade (#6-7008BW)

SPECIFICATIONS

| | |
|----------------|-----------------------------------|
| Item No | 60083 |
| Motor | 1 HP / 120 V ~ 60 Hz. / 6.25 Amps |
| Watts | 750 |
| RPM | 3300 |
| Blade Capacity | 7" |
| Arbor: | 5/8" |
| Rip Cut | Unlimited |
| Diagonal Cut | Unlimited |
| Depth of Cut | 1-1/5" |
| Size | 22.2" L x 21.6" W x 11" H |
| Weight | 38.68 lbs. |

ACCESSORIES INCLUDED

- Laser cutting guide
- Locking rip guide
- Angle cutting guide
- Universal wrench
- 7" continuous rim wet diamond blade (6-7003Q)

7" Tile Wet Saw with Rear Support

QEP



- Unique back extension table to support large format tile during cut
- Powerful 3/4 Peak HP motor for cutting ceramic, slate, marble, granite and porcelain*
- Interior water baffle minimizes water spray and reduces refills
- Tilt-up cutting table for precision 22.5° and 45° miter cuts
- Locking adjustable angle and rip guides for accurate cuts

* for porcelain and hard tiles, we recommend QEP's Black Widow Blade (#6-7008BW)

SPECIFICATIONS

| | |
|----------------|---|
| Item No | 22750Q |
| Motor | 3/4-Peak HP / 120 V ~ 60 Hz. / 4.8 Amps |
| Watts | 550 |
| RPM | 3600 |
| Blade Capacity | 7" |
| Arbor: | 5/8" |
| Rip Cut | Unlimited |
| Diagonal Cut | Unlimited |
| Depth of Cut | 1-1/4" |
| Size | 21" L x 22.2" W x 9.5" H |
| Weight | 21.4 lbs. |

ACCESSORIES INCLUDED

- 7" continuous rim wet diamond blade (#6-7003Q)
- 45° angle guide
- Blade guard
- Rip guide
- Rear extension table

650XT 7" Tile Wet Saw

QEP



- Powerful 3/4 Peak HP motor for cutting ceramic, slate, marble, granite and porcelain*
- 8" extension table attaches to either side to support larger tiles
- Interior water baffle minimizes water spray and reduces refills
- Tilt-up cutting table for precision 22.5° and 45° miter cuts
- Locking adjustable angle and rip guides for accurate cuts

* for porcelain and hard tiles, we recommend QEP's Black Widow Blade (#6-7008BW)

SPECIFICATIONS

| | |
|----------------|---|
| Item No | 22650Q |
| Motor | 3/4-Peak HP / 120 V ~ 60 Hz. / 4.8 Amps |
| Watts | 550 |
| RPM | 3600 |
| Blade Capacity | 7" |
| Arbor: | 5/8" |
| Rip Cut | Unlimited |
| Diagonal Cut | Unlimited |
| Depth of Cut | 1-1/4" |
| Size | 20.08" L x 15.74" W x 9.88" H |
| Weight | 23 lbs. |

ACCESSORIES INCLUDED

- 7" continuous rim wet diamond blade (#6-7003Q)
- 45° angle guide
- Rip guide
- Universal wrench

7" Tile Wet Saw

QEP



- Direct-drive 3/4 HP motor is surprisingly quiet and delivers enough power to handle ceramic, slate, marble, granite and porcelain*
- Tilt-up cutting table for precision 15°, 30° and 45° miter cuts
- Adjustable rip and sliding angle guides for accurate production cuts
- Blade cooling water reservoir

* for porcelain and hard tiles, we recommend QEP's Black Widow Blade (#6-7008BW)

SPECIFICATIONS

| | |
|----------------|------------------------------------|
| Item No | 22500 |
| Motor | 3/4 HP / 120 V ~ 60 Hz. / 4.8 Amps |
| Watts | 550 |
| RPM | 3600 |
| Blade Capacity | 7" |
| Arbor: | 5/8" |
| Rip Cut | Unlimited |
| Diagonal Cut | Unlimited |
| Depth of Cut | 1-1/4" |
| Size | 15.8" L x 15.4" W x 6" H |
| Weight | 14 lbs. |

ACCESSORIES INCLUDED

- Locking rip guide
- Angle cutting guide
- Universal wrench
- 7" continuous rim wet diamond blade (6-7003Q)

Master Cut™ 7" Portable Tile Saw

QEP



- Direct-drive 3/5 HP motor for cutting ceramic, slate, marble, granite and porcelain*
- Tilt-up cutting table for precision 15°, 30° and 45° miter cuts
- Adjustable rip guide for accurate production cuts
- Automatic thermal overload protection prevents tile saw from overheating and damaging the internal parts of the motor
- Removable water tray for easy cleaning

* for porcelain and hard tiles, we recommend QEP's Black Widow Blade (#6-7008BW)

SPECIFICATIONS

| | |
|----------------|------------------------------------|
| Item No | 60089Q |
| Motor | 3/5 HP / 120 V ~ 60 Hz. / 3.8 Amps |
| Watts | 450 |
| RPM | 3600 |
| Blade Capacity | 7" |
| Arbor: | 5/8" |
| Rip Cut | Unlimited |
| Diagonal Cut | Unlimited |
| Depth of Cut | 1-5/16" |
| Size | 15.1" L x 15.6" W x 9" H |
| Weight | 23 lbs. |

ACCESSORIES INCLUDED

- Rip guide
- Angle guide
- Tilt-up table for easy miter cuts
- Two wrenches
- 7" continuous rim wet diamond blade (6-7003Q)

4" Torque Master XT

QEP



- 3/5 HP, hi-torque geared motor for maximum cutting performance
- Dual extension tables add extra 5" of cutting surface
- Cuts ceramic tile, porcelain tile*, marble, slate and stone
- Fully adjustable miter guide with unique ratchet mechanism
- Cutting table is hinged to adjust for making 22.5° and 45° miter cuts
- Water recirculation system saves time when replenishing water supply and keep work area drier
- 4" diamond blade (6-4001Q)

* for porcelain and hard tiles, we recommend QEP's Black Widow Blade (#6-4008BW)

SPECIFICATIONS

| | |
|----------------|---------------------------------------|
| Item No | 22400Q |
| Motor | 3/5-Peak HP / 120 V ~ 60 Hz. / 4 Amps |
| Watts | 450 |
| RPM | 4600 |
| Blade Capacity | 4" |
| Arbor: | 5/8" |
| Rip Cut | Unlimited |
| Diagonal Cut | Unlimited |
| Depth of Cut | 3/4" |
| Size | 14.3" L x 15.8" W x 4.6" H |
| Weight | 8 lbs. |

ACCESSORIES INCLUDED

- 4" continuous rim diamond blade (#6-7003Q)
- 45° angle guide
- Blade guard
- Rip guide
- Rear extension table

TILE SAWS AT A GLANCE

Standing Saws

| ITEM NO. | DESCRIPTION | SIZE (L x W x H) | WEIGHT (lbs.) | BLADE | ARBOR | HP | AMPS | WATTS | RPM | RIP CUT (Tile Size) | DIAGONAL (Tile Size) | CUTTING DEPTH | WATER PUMP | ACCESSORIES INCLUDED |
|----------|-----------------------------|---------------------------------|---------------|-------|-------|-------|------|-------|-----------|---------------------|----------------------|---------------|------------|------------------------------|
| 83230 | 30" Professional Bridge Saw | 46.3" x 19.8" x 57.5" (w/stand) | 121.3 | 8" | 5/8" | 1-1/2 | 10.5 | 1362 | 3260 | 30" | 22" | 1-1/2" | #60098 | A, B, C, D, F, G, J, K, L, M |
| 83200 | 24" Bridge Saw | 37" x 18" x 47.5" (w/stand) | 82.32 | 8" | 5/8" | 1-1/2 | 9.2 | 1100 | 3550 | 24" | 18" | 1-1/2" | #60098 | A, B, D, E, G, I, J, K, L |
| 61900Q | 10" Professional Tile Saw | 50.75" x 33" x 47.5" (w/stand) | 101.39 | 10" | 5/8" | 2.25 | 15 | 1750 | 3600 | 24" | 18" | 3-3/4" | #61900Q-31 | A, B, D, F, G, I, J, K, L, M |
| 61024 | 24" Professional Tile Saw | 40" x 21.5" x 48.3" (w/stand) | 105.8 | 10" | 5/8" | 1-1/2 | 9.5 | 1100 | 3450 | 24" | 18" | 2-3/8" | #60095 | A, B, D, F, G, K, J, L, M |
| 60020SQ | 24" Dual Speed Tile Saw | 40" x 22" x 47" (w/stand) | 116 | 10" | 5/8" | 2 | 15 | 1500 | 1750/2450 | 20" | 14" | 3-1/4" | #60095 | A, B, C, G, H, I, K |

Table Saws

| ITEM NO. | DESCRIPTION | SIZE (L x W x H) | WEIGHT (lbs.) | BLADE | ARBOR | HP | AMPS | WATTS | RPM | RIP CUT (Tile Size) | DIAGONAL (Tile Size) | CUTTING DEPTH | WATER PUMP | ACCESSORIES INCLUDED |
|----------|----------------------------------|----------------------|---------------|-------|-------|-----|------|-------|------|---------------------|----------------------|---------------|------------|----------------------|
| 60083Q | 7" Professional Tile Saw | 22.2" x 21.6" x 11" | 38.68 | 7" | 5/8" | 1 | 6.25 | 750 | 3300 | Unlimited | Unlimited | 1-1/5" | N/A | B, G, H, I, J, K, N |
| 22750Q | 7" Tile Wet Saw | 21" x 22.2" x 9.5" | 21.4 | 7" | 5/8" | 3/4 | 4.8 | 550 | 3600 | Unlimited | Unlimited | 1-1/4" | N/A | B, F, G, H, I, K, N |
| 22650Q | 650XT 7" Tile Wet Saw | 20" x 15.7" x 9.8" | 19.2 | 7" | 5/8" | 3/4 | 4.8 | 550 | 3600 | Unlimited | Unlimited | 2-1/4" | N/A | B, F, G, H, K, N |
| 22500 | 7" Tile Wet Saw | 15.8" x 15.4" x 6" | 14 | 7" | 5/8" | 3/4 | 4.8 | 550 | 3600 | Unlimited | Unlimited | 1-1/4" | N/A | B, G, H, K, N |
| 60089Q | Master Cut™ 7" Portable Tile Saw | 15.1" x 15.6" x 9" | 26 | 7" | 5/8" | 3/5 | 3.8 | 450 | 3600 | Unlimited | Unlimited | 1-5/16" | N/A | B, G, H, K, N |
| 22400Q | 4" Torque Master XT | 14.3" x 15.8" x 4.6" | 8 | 4" | 5/8" | 3/5 | 4 | 450 | 4600 | Unlimited | Unlimited | 3/4" | N/A | B, F, G, H, N |

ACCESSORY GUIDE:

- | | | | |
|-------------------------------------|------------------------------------|-------------------------------------|-----------------------------------|
| A. Water Pump | E. Rear wheel attachments | I. Handle(s) | M. Plunge cut capable |
| B. Continuous rim wet diamond blade | F. Side/rear extension table(s) | J. Laser cutting guide | N. Self contained water reservoir |
| C. Heavy duty legs / fold-out stand | G. Angle/rip cutting guide | K. Wrench, wrenches and/or hex keys | |
| D. Folding stand w/ locking wheels | H. 45° miter cutting guide / block | L. Tilting head | |

Continuous Rim Blades

The Q.E.P. diamond blade line offers a blade for every application and budget. Whether your tile project requires the cutting of ceramic, porcelain, marble, granite, glass, slate, concrete pavers or stone, Q.E.P. has a blade that will cut it quickly and efficiently. The high quality of Q.E.P.'s diamond blades is due to our stringent testing and exact specifications assuring the user a wobble-free blade that produces smooth and precise cuts.



Black Series

General purpose blade for wet or dry cutting of ceramic tile.

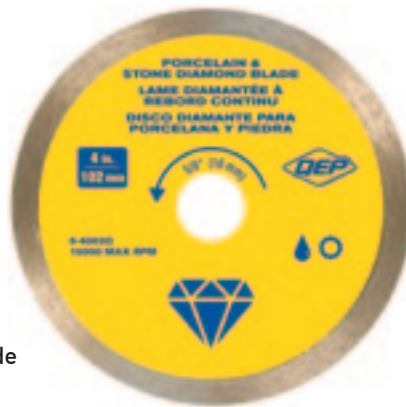

Gold Series

Premium blade for wet or dry cutting of ceramic, porcelain and marble tile.

| Item No. | Description | Application | Rim Height | Width | Arbor Size | Max RPM | No. in Case |
|----------|------------------------------|----------------------------|------------|-------|----------------|---------|-------------|
| 6-4001Q | 4" Continuous Rim - Wet/Dry | Ceramic tile | 7mm | .060 | 5/8"-20mm-7/8" | 15000 | 10 |
| 6-7001Q | 7" Continuous Rim - Wet/Dry | Ceramic tile | 7mm | .060 | 7/8"-5/8"-DM | 8730 | 10 |
| 6-8001Q | 8" Continuous Rim - Wet/Dry | Ceramic tile | 7mm | .060 | 7/8"-5/8"-DM | 7640 | 10 |
| 6-1001Q | 10" Continuous Rim - Wet/Dry | Ceramic tile | 7mm | .060 | 7/8"-5/8"-DM | 6115 | 10 |
| 6-4003Q | 4" Continuous Rim - Wet/Dry | Ceramic, Porcelain, Marble | 7mm | .060 | 5/8"-20mm-7/8" | 15000 | 8 |
| 6-7003Q | 7" Continuous Rim - Wet | Ceramic, Porcelain, Marble | 7mm | .060 | 5/8" | 8730 | 8 |
| 6-8003Q | 8" Continuous Rim - Wet | Ceramic, Porcelain, Marble | 7mm | .060 | 5/8" | 7640 | 8 |
| 6-1003Q | 10" Continuous Rim - Wet | Ceramic, Porcelain, Marble | 7mm | .060 | 5/8" | 6115 | 8 |

Black Widow® Blades

Black Widow Diamond blades are designed for quick cutting of hard tile including porcelain, ceramic, granite and marble, without wobble or chipping. Independent lab test results have proven that Black Widow specialty blades continuously outperform the competition in durability for a longer life and speed of cut, reducing project time.



- Premium-grade, thin-rim diamond blade for fast wet cutting of porcelain, ceramic, granite and marble tile
- Ideal for high speed cutting of hard masonry tile
- Unique diamond-shaped laser cutouts prevent blade wobble and keep blade cooler for a longer life
- 7 mm rim height for a longer life and for increased cutting contact with the blade

| Item No. | Description | Application | Rim Height | Width | Arbor Size | Max RPM | No. in Case |
|----------|-----------------|---|------------|-------|----------------|---------|-------------|
| 6-4008BW | 4" BLACK WIDOW | Ceramic, Porcelain, Marble, Granite - Wet/Dry | 7mm | .060 | 5/8"-20mm-7/8" | 15000 | 5 |
| 6-7008BW | 7" BLACK WIDOW | Ceramic, Porcelain, Marble, Granite - Wet | 7mm | .060 | 5/8" | 8730 | 5 |
| 6-8008BW | 8" BLACK WIDOW | Ceramic, Porcelain, Marble, Granite - Wet | 7mm | .060 | 5/8" | 7640 | 5 |
| 6-1008BW | 10" BLACK WIDOW | Ceramic, Porcelain, Marble, Granite - Wet | 7mm | .060 | 5/8" | 6115 | 5 |

Laser Welded, Segmented Blades

Premium long-life contractor-grade segmented blade for fast cutting of brick, concrete block and pavers.



| Item No. | Description | Application | Rim Height | Width | Arbor Size | Max RPM | No. in Case |
|----------|------------------------|-------------------------------|------------|-------|--------------|---------|-------------|
| 6-7003SG | 7" Segmented - Wet/Dry | Brick, Concrete Block, Pavers | 7mm | .085 | 5/8"-7/8"-DM | 8730 | 10 |

Turbo Blades

Premium multipurpose contractor-grade turbo blade for smooth cutting of brick, concrete block, pavers and stone



| Item No. | Description | Application | Rim Height | Width | Arbor Size | Max RPM | No. in Case |
|-----------|----------------------------|--------------------------------------|------------|-------|--------------|---------|-------------|
| 6-7003TB | 7" BRUTUS® Turbo - Wet/Dry | Brick, Concrete Block, Pavers, Stone | 7mm | .085 | 5/8"-7/8"-DM | 8730 | 10 |
| 6-4005TBQ | 4" QEP Turbo - Wet/Dry | Brick, Concrete Block, Pavers, Stone | 7mm | .095 | 5/8"-7/8"-DM | 1500 | 10 |
| 6-7005TBQ | 7" QEP Turbo - Wet/Dry | Brick, Concrete Block, Pavers, Stone | 7mm | .095 | 5/8"-7/8"-DM | 8730 | 10 |

7" Glass Tile Cutting Diamond Blade

QEP



- Premium blade for the wet cutting of glass tile
- Rim height 7 mm
- Blade width .06"
- Maximum RPM of 8730
- 5/8" arbor

6-7006GLQ 7" Glass Tile Cutting Diamond Blade (3/cs)

Submersible Tile Saw Water Pump

QEP

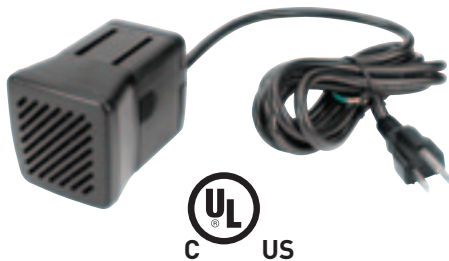

For 83230Q and 83200Q Tile Saws

- Pumps 60 Gal (227.4L) per hour using 2' tubing (tubing not included)
- Corrosion resistant plastic housing for increased durability
- Removable easy-to-clean filter included

60098 120 V Submersible Tile Saw Water Pump (1/cs)

Submersible Tile Saw Water Pump

QEP



For 61024 and 60020SQ Tile Saws

- Pumps 54 Gal (203 L) per hour using 2' long tubing (tubing not included)
- Corrosion resistant plastic housing for increased durability
- Extra large intake reservoir with removable easy-to-clean filter

60095 120V Submersible Tile Saw Water Pump (1/cs)

4" Professional Handheld Tile Saw

QEP



- Ideal for cutting tile, stone, granite, block, brick and marble
- Adjustable steel base to change cutting depth and angle
- Bevel cuts from 0° - 45°

* Saw is not UL approved with water adapter kit attached

21643 4" Professional Handheld Tile Saw (1/cs)

Power Mixer with Paddle

BRUTUS



Included Chuck Kit

- Mix mortar, thinset, grout and other viscous materials with minimal effort
- Strong enough to mix cement
- High quality, powerful 1300 Watt motor
- High torque 2- speed motor:
1st gear: 180-460 RPM
2nd gear: 300-700RPM
- Male-threaded 2-piece paddle specially designed to completely mix full bucket loads of viscous materials
- Variable speed dial controls RPM's, which prevents splashing at start-up
- Includes chuck kit for use with non-threaded mixer paddles

21665 Power Mixer w/ Paddle (1/cs)

21661 One-piece replacement paddle (1/cs)

SPECIFICATIONS

| | |
|---------|---|
| Item No | 21665 |
| Motor | 120 V ~ 1300 Watts - 2-speed 1st gear: 180 - 460 RPM, 2nd gear: 300 - 700 RPM |
| Amps | 11 |
| Weight | 13 lbs. |

Plastic Mixing Buckets

QEP



- Durable white opaque plastic buckets with handles

78200 5 Gallon Plastic Mixing Bucket - White (6/cs)

78208 3-1/2 Gallon Plastic Mixing Bucket - White (1/cs)

78217 15 Litre Plastic Mixing Bucket - White (1/cs) Canada Only

78300 10 Litre Plastic Mixing Bucket - White (1/cs) Canada Only

78201 Pour Spout Lid for 78200, 78217 & 78300 (1/cs)

Threaded Spiral Mixing Paddle

QEP

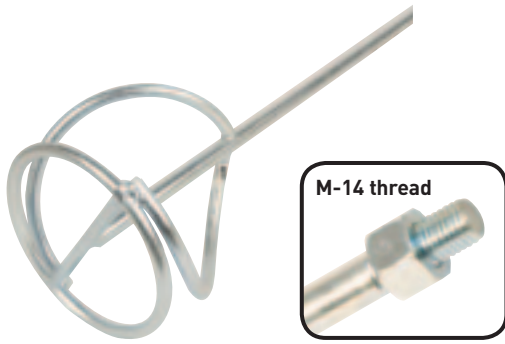

- Replacement paddle for 21660Q, 21665 or any mixer that accepts M14 thread
- Specially designed paddle for fast and effective mixing of thick and dense materials
- M-14 thread design for paddle stability during mixing
- Shaft diameter 1/2", length 24", blade width 5-1/2"

21661 Threaded Mixing Paddle (1/cs)

Thinset and Grout Mixing Paddle

QEP / TILEFORCE

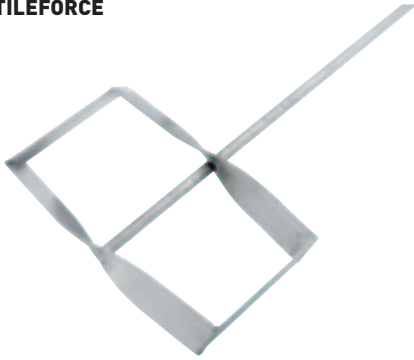

- Mixes grouts, thinsets and other setting materials with a minimum of air
- Fits standard 1/2" or 3/8" drill chuck
- Shaft diameter 3/8", length 19-1/2", blade width 8-3/8"

QEP

75001Q Thinset and Grout Mixing Paddle (6/cs)

TILEFORCE

82422TF Thinset and Grout Mixing Paddle (6/cs)

Mixing Paddle

QEP / BRUTUS

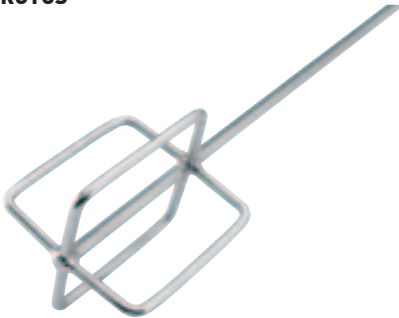

- Preferred by professionals for fast and easy mixing of grouts, thinsets and other setting materials
- Fits standard 1/2" or 3/8" drill chuck
- Shaft diameter 3/8", length 22", blade width 5"
- Chrome plated steel

QEP

61205Q Mixing Paddle (6/cs)

BRUTUS

82421BR PRO Mixing Paddle (6/cs)

Universal Mixing Paddle

QEP / TILEFORCE



- The special design of the blades takes the stress and high torque off the drill, excellent for cordless drills
- The optimal mixing tool for small volumes of thinsets, mortars, cement, plaster and similar viscous materials
- Fits standard 1/2" or 3/8" drill chuck
- Shaft diameter 3/8", length 16", blade width 3-1/4"
- Powder coated steel

QEP

61210Q Universal Mixing Paddle (12/cs)

TILEFORCE

82423TF Universal Mixing Paddle (12/cs)

Porcelain Diamond Drill Bit with Water Delivery System

QEP / BRUTUS



- Ideal for cutting holes when installing towel bars, soap dishes, shelves, cabinets and shower door frames
- Diamond Grit edge drills through ceramic, glass, marble, porcelain and granite
- Drill guide and water delivery system included (use wet-only)
- Fits standard 1/2" or 3/8" drill chucks

QEP

10566Q 5/16" Porcelain Diamond Drill Bit w/Drill Guide and Water Cooling System (6/cs)

10568Q 1/4" Porcelain Diamond Drill Bit w/Drill Guide and Water Cooling System (6/cs)

10567 Diamond Drill Bit Mounting Tape (12 pc/bag)

BRUTUS

82414BR 5/16" Porcelain Diamond Drill Bit w/Drill Guide and Water Cooling System (6/cs)

Porcelain Diamond Hole Saw with Water Delivery System

QEP / BRUTUS



- For cutting 1-3/8" diameter holes in glass, ceramic, porcelain, marble and granite
- Special diamond grit edge for faster smoother cuts
- Included drill guide and water cooling cup easily supplies water to drill bit (use wet-only)
- Fits standard 1/2" or 3/8" drill chucks

QEP

10569Q 1-3/8 Porcelain Diamond Hole Saw w/Drill Guide and Water Cooling System (6/case)

10570 1-3/8 Hole Saw Mounting Tape (12 pc/bag)

BRUTUS

82413BR 1-3/8 Porcelain Diamond Hole Saw w/Drill Guide and Water Cooling System (6/case)

Porcelain Diamond Drill Bit / Hole Saw

QEP



- For cutting holes in glass, ceramic, porcelain, marble and granite
- Special diamond grit edge for faster smoother cuts, with less water
- Does not require water cooling guide or cup
- Fits standard 1/2" or 3/8" drill chucks

QEP

10075QC 1/4" Diamond Drill Bit (6/cs)

10080QC 5/16" Diamond Drill Bit (6/cs)

10087QC 1-3/8" Diamond Hole Saw (6/cs)

35" & 24" Tile Cutters

QEP

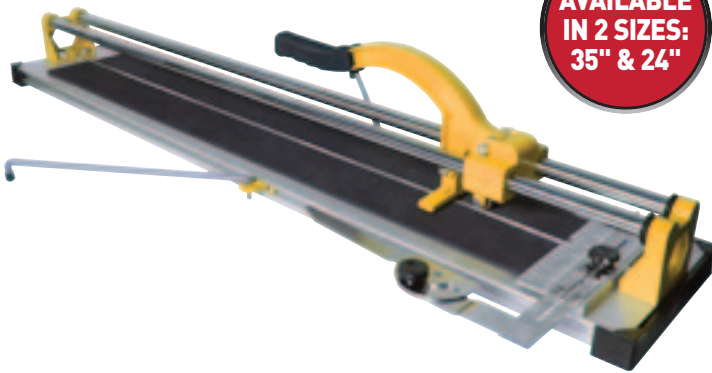

AVAILABLE
IN 2 SIZES:
35" & 24"

- Ball bearing slide for smooth scoring
- Multipurpose cutter for most large format tile including ceramic and porcelain
- Side arm extensions to support large format tiles
- Equipped with replaceable 7/8" titanium-coated tungsten carbide ball bearing cutting wheel
- Durable chrome plated steel rails
- Rip/Angle guide for fast multiple cuts

10900Q 35" Tile Cutter - (1/cs) Cuts tile up to 35", 24" diagonally, 1/2" thick

10630Q 24" Tile Cutter - (1/cs) Cuts tile up to 24", 17.5" diagonally, 1/2" thick

21125 7/8" Titanium-Coated Tungsten Carbide Cutting Wheel (6/cs)

27" & 20" Big Clinker Professional Tile Cutters

BRUTUS

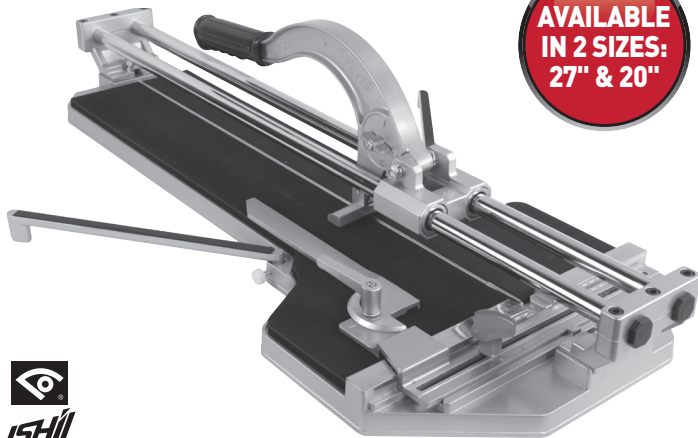

AVAILABLE
IN 2 SIZES:
27" & 20"

- Multipurpose cutter for most tile including ceramic and porcelain
- Height adjustable 4-position wheel for easy snapping in any position on tile
- Equipped with replaceable 7/8" titanium-coated tungsten carbide ball bearing cutting wheel
- Side arm extensions to support large format tiles
- Durable chrome plated steel rails
- Rip/Angle guide for fast multiple cuts
- Heavy duty cast aluminum base

10800 27" Big Clinker Tile Cutter - (1/cs) Cuts tile up to 27", 20" diagonally, 1/2" thick

10500 20" Big Clinker Tile Cutter - (1/cs) Cuts tile up to 20", 16" diagonally, 1/2" thick

21123Q 7/8" Titanium-Coated Tungsten Carbide Cutting Wheel (6/cs)



24" Big Clinker Professional Tile Cutter

BRUTUS



- Cuts wall and floor tile up to 24", 18" diagonally, 1/2" thick
- Height adjustable 4-position wheel for easy snapping in any position on tile
- Equipped with replaceable 7/8" titanium-coated tungsten carbide ball bearing cutting wheel
- Side arm extensions to support large format tiles
- Durable chrome plated steel rails
- Rip/Angle guide for fast multiple cuts
- Heavy duty cast aluminum base
- Extra thick 3/8" padding

10600BR 24" Big Clinker Tile Cutter - (1/cs)

21123Q 7/8" Titanium-Coated Tungsten Carbide Cutting Wheel (6/cs)



20" Tile Cutter

BRUTUS



- Cuts wall and floor tile up to 20", 14" diagonally, 1/2" thick
- Equipped with two replaceable 7/8" titanium-coated tungsten carbide cutting wheels
- Heavy duty die cast aluminum base

10552BR 20" Tile Cutter (1/cs)

10117 7/8" Titanium-Coated Tungsten Carbide Cutting Wheel (3/cs)

10119Q 7/8" Tungsten Carbide Cutting Wheel (3/cs)

20" Tile Cutter

QEP

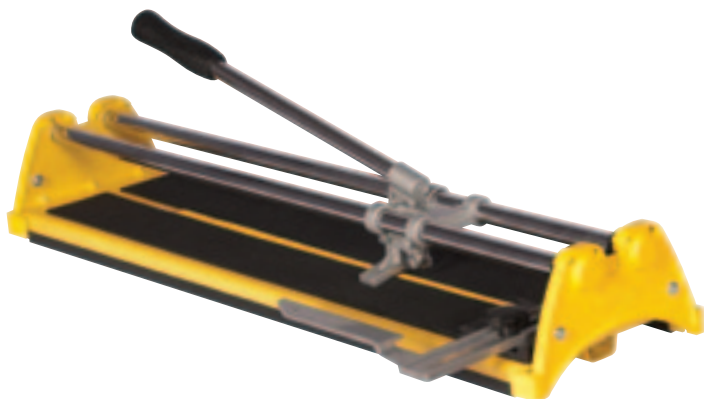

- Cuts wall and floor tile up to 20", 14" diagonally, 1/2" thick
- Equipped with replaceable 1/2" titanium-coated tungsten carbide cutting wheel
- Reinforced steel base

10220Q 20" Tile Cutter (4/cs)

10010HD 1/2" Titanium-Coated Tungsten Carbide Cutting Wheel (3/cs)

14" Tile Cutter

QEP



- Cuts wall and floor tile up to 14", 10" diagonally, 1/2" thick
- Equipped with replaceable 1/2" titanium-coated tungsten carbide cutting wheel

10214Q 14" Tile Cutter (6/cs)

10010HD 1/2" Titanium-Coated Tungsten Carbide Cutting Wheel (3/cs)

14" Tile Cutter

QEP



- Cuts wall and floor tile up to 14", 10" diagonally, 3/8" thick
- Equipped with replaceable 7/8" titanium-coated tungsten carbide cutting wheel
- Non marring corner caps

| | |
|--------|--|
| 14000 | 14" Tile Cutter (4/cs) |
| 10117 | 7/8" Titanium-Coated Tungsten Carbide Cutting Wheel (3/cs) |
| 10119Q | 7/8" Tungsten Carbide Cutting Wheel (3/cs) |

12" & 13" Tile Cutter

QEP



- Cuts wall and floor tile up to 12", 8" diagonally
- Equipped with long lasting 1/2" tungsten carbide cutting wheel

| | |
|---------|---|
| 10267Q | 12" Tile Cutter (6/cs) |
| 10268B | 13" Tile Cutter (1/cs) |
| 10010HD | 1/2" Tungsten Carbide Cutting Wheel for 10267Q and 10268Q (12/cs) |

Replacement Wheels for Tile Cutters

| ITEM NO. | DESCRIPTION | 10010HD | 10117 | 10119Q | 21123Q | 21125 |
|----------|-----------------------------|---------|-------|--------|--------|-------|
| 10900Q | 35" Tile Cutter | | | | | • |
| 10800 | 27" Big Clinker Tile Cutter | | | | • | |
| 10630Q | 24" Tile Cutter | | | | | • |
| 10600BR | 24" Big Clinker Tile Cutter | | | | • | |
| 10500 | 20" Big Clinker Tile Cutter | | | | • | |
| 10552 | 20" Tile Cutter | | • | • | | |
| 10220Q | 20" QEP Tile Cutter | • | | | | |
| 10214Q | 14" QEP Tile Cutter | • | • | • | | |
| 14000 | 14" Tile Cutter | | • | • | | |
| 10268B | 13" Tile Cutter | • | | | | |
| 10267Q | 12" Tile Cutter | • | | | | |

Compound Tile Nipper

QEP / BRUTUS



- Compound mechanism delivers 3 times more force with less effort
- Use to make irregular cuts on all types of tiles, including porcelain
- Durable tungsten carbide tip provides a long cutting life

QEP

32035Q Compound Tile Nipper (6/cs)

BRUTUS

80035BR Compound Tile Nipper (6/cs)

Tile Nipper GT

BRUTUS



- Premium quality 8" carbide tipped tile nipper
- 5/8" carbide tipped offset jaws and center spring
- For use with all types of tiles, including porcelain

32015-6 Tile Nipper GT (6/cs)

Tile Nipper

QEP / TILEFORCE



- 8" carbide tipped nippers with offset jaws
- Ideal for cutting ceramic and porcelain tile
- 5/8" carbide tipped offset jaws and center spring

QEP

10003Q Tile Nipper (12/cs)

TILEFORCE

82418TF Tile Nipper (12/cs)

Glass Tile Nipper

QEP / BRUTUS



- Cuts glass from 1/32" to 1/4" in thickness
- Ideal for quickly cutting small mosaic pieces of glass and removing tiny points from glass tile

QEP

32010Q Glass Tile Nipper (6/cs)

BRUTUS

82432BR Glass Tile Nipper (6/cs)

Handheld Tile Cutter

QEP / TILEFORCE

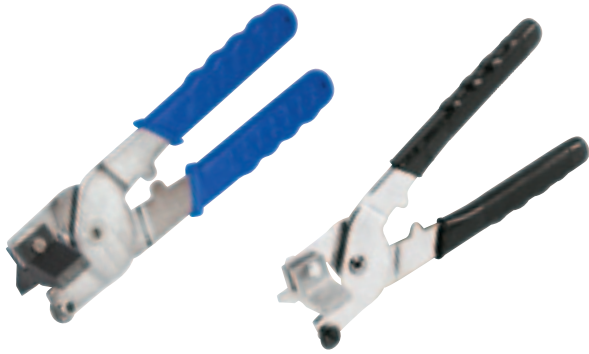

- Uses a durable tungsten carbide wheel for scoring and a breaker bar to “snap” ceramic tile

QEP

32024Q Handheld Tile Cutter (6/cs)

TILEFORCE

82410 Handheld Tile Cutter (6/cs)

10" Contour Gauge

QEP / TILEFORCE



- Duplicates any shape for easy transfer to tile and other surfaces
- Durable plastic teeth - will not rust

QEP

10032Q 10" Contour Gauge (6/cs)

TILEFORCE

82431 10" Contour Gauge (6/cs)

Tile Scorer

VITREX



- Tungsten carbide tip is built to last
- Suitable for scoring both wall and floor tile
- Can be used for ceramic and porcelain tile

A09620 Tile Scorer (10/cs)

Chalk and Line Reel

ROBERTS



- Special formula prevents caking and clotting

10-3035 Chalk Reel (6/cs)

10-321 White Chalk, 8 oz. (48/cs)

Diamond Jigsaw Blade

QEP



- Cuts hard materials including porcelain, ceramic and glass tile
- Cuts faster and cleaner than standard carbide blades

10585QC 3" Diamond Jigsaw Blade (6/cs)

Saber Saw Blade

QEP



- For cutting shapes in ceramic tile

10014Q 3" Saber Saw Blade (5/cs)

Rod Saw & Drill Bit

TILEFORCE



- Cuts irregular shapes and circles from the center of tiles
- Cuts ceramic, tile, marble and other types of tile (Not recommended for porcelain tile)

82417 Rod Saw and Drill Bit (6/cs)

Undercut Saw

QEP / TILEFORCE



- 10-point aggressive tooth design for faster, cleaner cuts
- High-carbon steel blade for added strength
- Ideal for undercutting door jambs
- Ergonomic comfort grip handle

QEP

10096Q Undercut Saw (6/cs)

TILEFORCE

82403TF Undercut Saw (6/cs)

Ceramic & Marble File

QEP / TILEFORCE

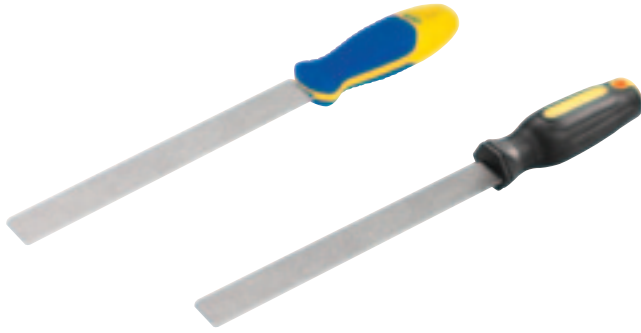

- Extra wide 1" x 7-3/4" carbide dual grit filing surfaces
- Fine grit for minor smoothing, coarse grit for smoothing harder surfaces
- Smooths and shapes marble, stone and ceramic tile edges
- Also good for use on saltillo tile
- Comfort grip handle

QEP

10091Q Ceramic & Marble File (6/cs)

TILEFORCE

82404TF Ceramic & Marble File (6/cs)

Diamond Grit File

QEP

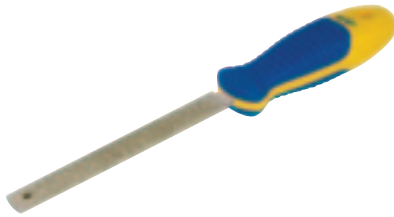

- The high quality diamond bond strength maintains a tough grit surface for working with the hardest materials, including ceramic, porcelain, glass and stone
- Flat/round profiles allow for smoothing both straight and curved edges

10586Q Diamond Grit File (6/cs)

Dual Grit Rubbing Stone

QEP / TILEFORCE



- Dual grit surfaces smooth rough edges on freshly cut ceramic & porcelain tile, stone, marble and brick
- Medium 60-grit on one side and fine 80-grit on the other
- Great for dressing diamond blades

QEP

10022Q Dual Grit Rubbing Stone (6" x 2" x 1") (6/cs)

TILEFORCE

82426TF Dual Grit Rubbing Stone (6" x 2" x 1") (6/cs)

Tile Sander

TILEFORCE

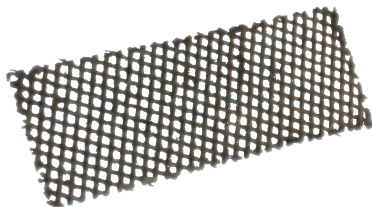

- For smoothing rough tile edges
- Slightly flexible for shaping curves
- Can also be used for plaster and wood

82420 Tile Sander (12/cs)

Grout Grabber

QEP / BRUTUS



- Attach to any reciprocating saw for quick grout removal
- Use any combination of 1 to 4 blades for grout joints from 1/16" up to 1/2" wide
- Curved carbide grit edge removes grout quickly & easily

QEP

75009Q Grout Grabber w/ two blades (12/cs)

75011Q Replacement Carbide Blades 2 pack (6/cs)

BRUTUS

89009BR Grout Grabber w/ two blades (12/cs)

89011BR Replacement Carbide Blades 2 pack (6/cs)

Pro Grout Saw

QEP / BRUTUS



- Curved heavy duty carbide blades easily remove stubborn grout
- Specially designed handle design provides control and leverage

QEP

10092Q Pro Grout Saw (6/cs)

75011Q Replacement Carbide Blades 2 pack (6/cs)

BRUTUS

82400BR Pro Grout Saw (12/cs)

89011BR Replacement Carbide Blades 2 pack (6/cs)

Grout Saw

QEP / TILEFORCE



- For stripping, cleaning and removing old grout
- Equipped with: 1 carbide grit edge and 1 steel tooth blade
- Use 2 blades for floor grout removal, 1 steel blade for walls

QEP

10012Q Grout Saw (12/cs)

10025Q Replacement Blade Set (1 grit edge/1 steel) (6/cs)

TILEFORCE

82401TF Grout Saw (12/cs)

82428 Replacement Blade Set (1 grit edge/1 steel) (6/cs)

Grout Remover

QEP / TILEFORCE



- For removing unwanted grout, mortar, thinset, calcium, caulking and surface rust
- Durable carbide tips are reversible, providing six scraping edges for longer tool life
- Ergonomic comfort grip handle

QEP

10020Q Grout Remover (12/cs)

TILEFORCE

82402TF Grout Remover (12/cs)

Grout Brush

QEP



- Thick, durable nylon bristles clean in corners and grout lines
- Contoured padded handle for firm grip and comfort

20840Q Grout Brush (12/cs)

Grout & Tile Brush

QEP / TILEFORCE



- Thick, durable nylon bristles clean in corners and grout lines
- Curved handle design allows for cleaning in hard-to-reach places
- 7" long

QEP
20836-24 Grout and Tile Brush (24/cs)

TILEFORCE
82407 Grout and Tile Brush (24/cs)

Tile & Counter Brush

BRUTUS



- Solvent resistant polystyrene brush with soft bristles that is ideal for the cleaning tiles and work area
- Split-topped bristles brush away even the finest particles
- Durable nylon bristles offer superior scrubbing power
- Scratch-free soft bristles
- 7" x 3" x 1.5" brush head

60315BR Tile & Counter Brush (12/cs)

Counter Cleaning Brush

QEP



made in
USA

- 14" solvent resistant polystyrene brush
- Split-topped bristles brush away even the finest particles
- 6" x 2" x 1" brush head

60311 Silver Tip Flagged Counter Cleaning Brush (12/cs)

Suction Cup

QEP / BRUTUS



- For easy handling of non-porous tile, marble and glass during installation
- Holds up to 12 lbs.
- Suction cup pad is 4-1/2" in diameter
- 3-1/2" wide handle opening easily accommodates large hands

QEP
75000Q Suction Cup (6/cs)

BRUTUS
82427BR Suction Cup (3/cs)

Premium Tile Mallet

BRUTUS

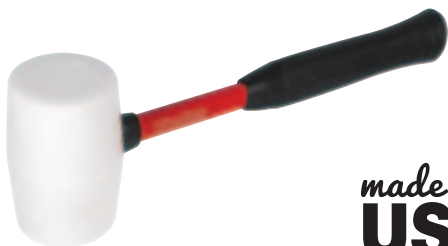

made in
USA

- 16 oz. premium non-marring head
- Lifetime warranted fiberglass handle – twice as strong as wood
- Softer mallet head designed specially for tile installations
- Comfort grip non-slip handle helps reduce hand fatigue
- Unique roll pin design prevents head from detaching, extending life of mallet
- 12-1/2" in length, 2" diameter rubber head

80620BR Premium Tile Mallet (6/cs)

White Rubber Mallet

QEP



- 16 oz. non-marring rubber head securely mounted on hardwood handle
- 12-1/2" in length, 2" diameter rubber head

61613 White Rubber Mallet (12/cs)

Grout Sealer Applicator

QEP / TILEFORCE



- Includes (2) roller wheels for multiple grout widths:
Use 1/8" wheel for grout joints 1/8" and smaller
Use 1/4" wheel for grout joints 1/4" and larger
- Works with all grout sealers
- Patented roller wheel system provides complete coverage
- Holds 12 oz. (355 ml)

QEP
10279Q Grout Sealer Applicator (12/cs)

TILEFORCE
82424TF Grout Sealer Applicator (12/cs)

Tile Tool Value Kit

QEP



- Complete kit containing all the tools necessary to install ceramic tile on floors
- Kit contains: Molded rubber float, 1/4" x 3/8" x 1/4" square notch floor trowel, 8" tile nippers, sponge, disposable gloves and reusable 2.5 gallon plastic bucket with complete installation instructions

78220Q Tile Tool Value Kit (1/cs)

Tile Installation Accessories

QEP

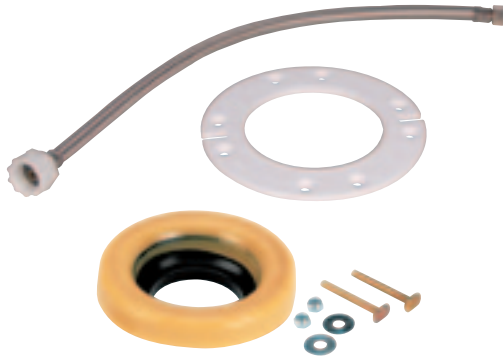

- 38229 Toilet Installation Kit with 12" Connector (1/cs)
Includes: Wm Harvey No-Seep, No. 50 Extra Thick Wax Gasket with Polyethylene Flange, Fluidmaster® 12" SS Braided Toilet Connector, Bolt Kit - 1/4" x 2-1/4" brass-plated closet bolts with nuts and washers
- 38232 Fluidmaster® 12" SS Braided Toilet Connector (1/cs)
- 38223 Johni-Ring® Large Wax Ring & Combo Kit (1/cs)
- 38233 No Seep Wax Ring No. 50 (1/cs)
- 38221 Toilet Bowl Wax Ring – bolts not included (6/cs)
- 38220 Bolt Kit – 1/4" x 2-1/4" brass-plated closet bolts with nuts & washers (12/cs)

Heavy Duty Grouting Gloves

QEP / TILEFORCE



- Protects hands from the corrosive action of grout, chemicals and other harsh substances
- 100% heavy duty latex is puncture and tear resistant
- One size fits all
- Non-slip ribbing on thumb and finger surfaces

QEP

21591Q Heavy Duty Grouting Gloves (24/cs)

TILEFORCE

82430TF Heavy Duty Grouting Gloves (24/cs)

Microfiber Epoxy Grout Cloth

QEP / BRUTUS

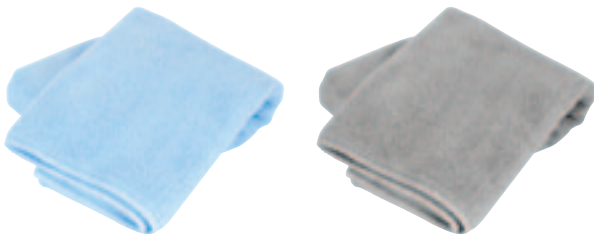

- Virtually eliminates grout haze
- Heavy duty 325 gram contractor grade, double sided
- Excellent for general purpose cleaning

QEP

70018Q Microfiber Epoxy Grout Cloth 18" x 18" (12/cs)

BRUTUS

81018BR Microfiber Epoxy Grout Cloth 18" x 18" (12/cs)

Cheese Cloth

QEP



- For removing grout haze after installation
- 5 square yards (36" x 180")
- Great for polishing most tile surfaces to a bright shiny finish
- 100% cotton, professional grade fine mesh

QEP

76030Q Cheese Cloth (12/cs)

Grout Bag

QEP / TILEFORCE



- Reinforced tip for smooth application and long life
- Protects hands from grout and other harsh substances
- Made of puncture and tear resistant coated vinyl

QEP
76000Q Grout Bag (12/cs)

TILEFORCE
82408TF Grout Bag (12/cs)

XL All-Purpose Sponge

QEP

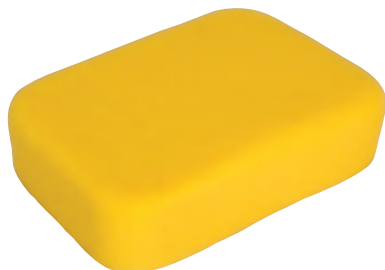

- Professional extra large premium sponge for grouting and clean up
- Unique hydrophilated design provides high water holding capacity
- Rounded edges minimize "digging out" or marring of grout
- 7-1/2" x 5-1/2" x 2"

QEP
70005Q XL All-Purpose Sponge, Individually bagged (36/cs)
70005Q-144 XL All-Purpose Sponge, Individually bagged in dump display (144/cs)
70005-450 XL All-Purpose Sponge, Bulk Bale (450/bulk wrapped bale)
70005Q-6D XL All-Purpose Sponge, Value 6 Pack in dump display (24/cs)

BRUTUS
82700BR-36 Grouting & Concrete Sponge, Individually bagged (36/cs)
82700BR-144 Grouting & Concrete Sponge, Individually bagged in dump display (144/cs)
82700BR-3D Grouting & Concrete Sponge, Value 3 Pack in dump display (48/cs)

Microfiber Polishing Sponge

QEP / BRUTUS



- Microfiber side ideal for cleaning grout, applying sealer and polishing tile
- Sponge side is great for washing and polishing cars, boats, countertops and furniture
- 7-1/2" x 5-1/2" x 2"

QEP
70010Q Microfiber Polishing Sponge (24/cs)

BRUTUS
81010BR Microfiber Polishing Sponge (24/cs)

Scrubbing Sponge

QEP / BRUTUS



- Professional hydrophilated grout sponge on one side and scrubbing sponge on the other creates dual usage
- Rounded edges minimize "digging out" or marring of grout
- 7-1/2" x 5-1/4" x 2"

QEP
70007Q Scrubbing Sponge, Individually bagged (36/cs)

BRUTUS
82701BR-36 Grout Sponge & Haze Remover, Individually bagged (36/cs)
82701BR-144 Grout Sponge & Haze Remover, Individually bagged in dump display (144/cs)

Maxflex Knee Pads

BRUTUS



- Non-scratch, non-skid outer shell
- All day comfort
- Adjustable straps fit all sizes

79638BR MAXFLEX Knee Pads (6/cs)

Professional Knee Pads

QEP / BRUTUS



- Extra large area offers maximum protection
- Comfort form-fitting foam padding
- Soft perspiration wicking fabric next to knee for maximum absorption
- Fast drying

QEP

79650Q XL Professional Knee Pads (4/cs)

BRUTUS

85650BR Pro Fit Knee Pads (4/cs)



Comfort Grip Non-Slip Knee Pads

QEP / BRUTUS



- Textured slip and mar resistant face – Perfect for hard floor surfaces including tile, wood and vinyl
- Comfort form-fitting foam padding
- Soft perspiration wicking fabric next to knee for maximum absorption
- Easy on and off adjustable no hassle plastic buckle
- Non-binding single strap will not pinch during extended wear

QEP

79630Q Comfort Grip Non-Slip Knee Pads (12/cs)

BRUTUS

85630BR Comfort Grip Non-Slip Knee Pads (12/cs)



Neoprene Knee Pads

QEP



- Lightweight neoprene knee pads offer all day comfort
- Form-fitting
- Washable and fast drying

79639Q Knee Pads (12/cs)

Contour Knee Pads

BRUTUS



- Cradles knee for maximum comfort
- Easy on-off velcro strap
- For hard or soft surfaces
- Washable

79637BR Contour Knee Pads (12/cs)

Hard Cap Knee Pads

ROBERTS



- Hard cap glides easily on soft flooring
- Nylon fabric with foam cushion
- Adjustable Velcro® straps

79023-6 Hard Cap Knee Pads (6/cs)

Foam Knee Pads

TILEFORCE



- Thick molded foam for comfort
- Lightweight and waterproof
- For hard or soft surfaces
- Velcro strap for secure fit

79635TF Foam Knee Pads (12/cs)

Premium Grout Float

QEP

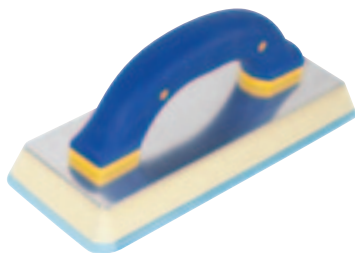

- Non-stick gum rubber ensures smooth application for all grout types including epoxy
- 2- rounded corners prevent gouging of grout joints
- 2- square corners ensure complete grout coverage in corners
- Extra thick aluminum backing plate for maximum leverage and applying grout into joints.
- Comfortable, contoured and cushioned grip handle reduces fatigue

10074Q Premium Grout Float 9-1/2" x 4" (8/cs)

Gum Rubber Grout Float

QEP / BRUTUS



- Non-stick gum rubber ensures smooth application
- 2-rounded corners prevent gouging of grout joints
- 2-square corners ensure complete grout coverage in corners
- Extra thick aluminum backing plate for maximum leverage and applying grout into joints
- Premium gum rubber laminated to lightweight, closed cell core is built to last

QEP

10061Q Gum Rubber Grout Float 9-1/2" x 4" (12/cs)

10063Q Gum Rubber Grout Float 12" x 4" (6/cs)

BRUTUS

82202BR Gum Rubber Grout Float 9-1/2" x 4" (12/cs)

82203BR Gum Rubber Grout Float 12" x 4" (6/cs)

Offset Grout Float

QEP / BRUTUS



- Non-stick gum rubber ensures smooth application
- 2- rounded corners prevent gouging of grout joints
- 2- square corners ensure complete grout coverage in corners
- Extra thick aluminum backing plate for maximum leverage and applying grout into joints. Ensures smooth application in those hard-to-reach areas

QEP

62422 Offset Grout Float 12" x 3" (6/cs)

BRUTUS

82207BR Offset Grout Float 12" x 3" (6/cs)

Molded Rubber Grout Float

QEP / BRUTUS



- Completely molded rubber pad prevents absorption of materials

QEP

10060Q Molded Rubber Grout Float 9-1/2" x 4" (12/cs)

BRUTUS

82201BR Molded Rubber Grout Float 9-1/2" x 4" (12/cs)

Economy Rubber Grout Float

QEP / TILEFORCE



- High-impact plastic handle with closed cell foam rubber pad for a smooth application

QEP

10062Q Economy Rubber Grout Float 9" x 4" (24/cs)

TILEFORCE

82200TF Economy Rubber Grout Float 9" x 4" (24/cs)

Epoxy Grout Float

BRUTUS



- Green pad with beveled sides resists epoxy grouts and other sticky materials

82205BR Epoxy Grout Float 9-1/2" x 4" (12/cs)

Margin Float

QEP / BRUTUS



- Ideal for hard-to-reach areas such as kitchen backsplashes or under bath and kitchen counters
- 6" x 2"

QEP

10073Q Margin Float 6" x 2" (12/cs)

BRUTUS

82208BR Margin Float 6" x 2" (12/cs)

LASH® Tile Leveling System

QEP / BRUTUS



made in
USA



Available in 2 sizes:

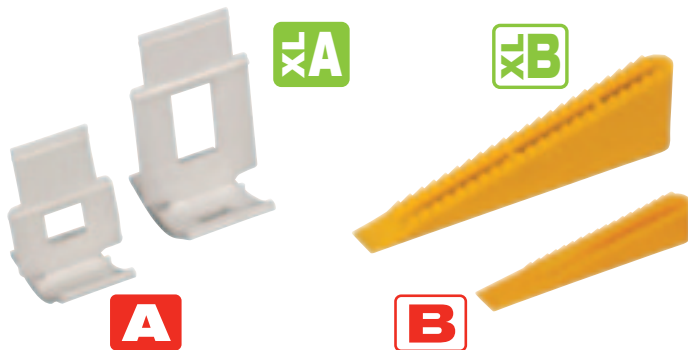

A + B for 3/16 in. to 7/16 in. tile

XL A + XL B for 1/2 in. to 3/4 in. tile

Watch a demonstration video at:
www.lashspacer.com

For perfect tile-to-tile leveling

The patented Tile Leveling Clips system is designed for quick installation and reduces costly call backs by insuring that the finished floor surface is lippage-free.

This time-saving system helps adjust the height of the tiles and evenly holds their edges throughout the curing process of the setting material.

- Durable nylon construction for a secure installation
- High-visibility yellow wedges are easy to distinguish on the job site
- Specially designed break-off point on clips for swift removal
- Produces 1/16" joint spacing
- May be combined with regular tile spacers for wider joints - up to 1/4"
- Wedges are reusable

Advantages to the installer:

- Very easy to learn and use at any skill level
- Great for use with tiles of varied thickness
- Requires minimal effort to install and remove
- Virtually eliminates lippage
- Prevents tile from moving during the installation
- Speeds up installations
- Less time at the job = more jobs in one day = more profit
- Decreases call-backs due to poor installation

QEP

| | | | |
|--------|-------------------------|--------------------------|--------|
| 99760Q | XL Tile Leveling Clips | 50 Qty | (8/cs) |
| 99765Q | XL Tile Leveling Wedges | 50 Qty | (8/cs) |
| 99720Q | Tile Leveling Clips | 96 Qty | (8/cs) |
| 99725Q | Tile Leveling Wedges | 96 Qty | (8/cs) |
| 99702 | Tile Leveling Clips | 4800 pc. Contractor Pack | |
| 99703 | Tile Leveling Wedges | 3600 pc. Contractor Pack | |

BRUTUS

| | | | |
|---------|----------------------|--------|--------|
| 87720BR | Tile Leveling Clips | 96 Qty | (8/cs) |
| 87725BR | Tile Leveling Wedges | 96 Qty | (8/cs) |

Tile Leveling System Pliers

QEP

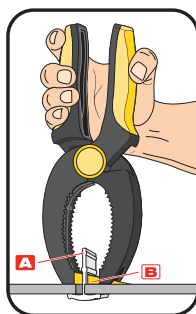

- Efficiently and easily pushes wedge into leveling clip
- Speeds up tile installation when using QEP LASH Tile Leveling System

99750Q Tile Leveling System Pliers (6/cs)

ClearView/Bulls•Eye 2-in-1 Tile Spacers

QEP / BRUTUS

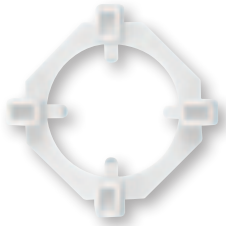

10067Q
87067BR

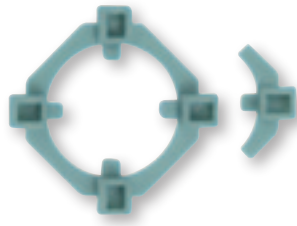

10068Q
87068BR

- Helps install tiles quickly and precisely
- One replaces four conventional style spacers
- Open center design allows the installer to instantly align tile corners

| QEP | | | |
|---------|---------------------------------|-----------------|--------|
| 10067Q | 1/16" & 3/16" Clearview Spacers | 100 Spacers | (8/cs) |
| | | 50 Spacer Wings | |
| 10068Q | 1/8" & 1/4" Clearview Spacers | 100 Spacers | (8/cs) |
| | | 50 Spacer Wings | |
| BRUTUS | | | |
| 87067BR | 1/16" & 3/16" Bulls•Eye Spacers | 100 Spacers | (8/cs) |
| | | 50 Spacer Wings | |
| 87068BR | 1/8" & 1/4" Bulls•Eye Spacers | 100 Spacers | (8/cs) |
| | | 50 Spacer Wings | |

Spacer wings fit perfectly on corner and angle applications!

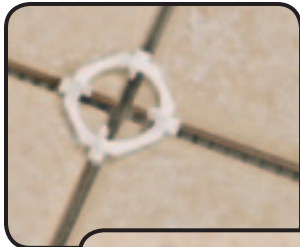

ClearView & Bulls•Eye Spacers are an economical and user-friendly solution for creating evenly spaced grout joints. The unique, patented design keeps the spacers out of the thinset and provides a clear view of grout lines and corners.

One Spacer does the job of four traditional spacers thus reducing the amount of total spacers needed for each job.

Each bag of Spacers comes with 100 spacer rings and 50 mini-wing spacers for use on corners along walls and angles. These spacers are easy to remove, reusable and perfect for floor and wall tile applications.

These spacers provide an unobstructed view of grout lines for dead on accuracy.

Two Spacers In One!
Offers the option of two different grout joint widths

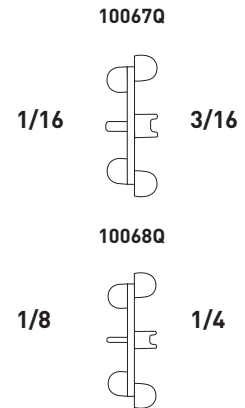

Leave-In Tile Spacers

BRUTUS



- Leave-In design reduces installation time
- Works great on large format tiles - rigid plastic will not compress
- Easy to handle, extra long prongs assure perfect 90° grout corners

| | | | |
|---------|------------------------|----------|---------|
| 99803BR | 1/16" Tile Spacers Bag | 300 Qty | (24/cs) |
| 99806BR | 1/16" Tile Spacers Bag | 1000 Qty | (8/cs) |
| 99804BR | 1/8" Tile Spacers Bag | 200 Qty | (24/cs) |
| 99807BR | 1/8" Tile Spacers Bag | 1000 Qty | (8/cs) |
| 99805BR | 3/16" Tile Spacers Bag | 100 Qty | (24/cs) |
| 99808BR | 3/16" Tile Spacers Bag | 500 Qty | (8/cs) |

Horseshoe Spacers

BRUTUS



- Non compressive
- Ideal for marble, granite, stone, large format tiles and vertical installations. (In place of 2nd bullet below)
- Allows user to lift both corners and align the joints from tile to tile

| | | | |
|---------|-----------------------------|---------|---------|
| 99800BR | 1/16" Horseshoe Spacers Bag | 200 Qty | (12/cs) |
| 99801BR | 1/8" Horseshoe Spacers Bag | 150 Qty | (12/cs) |
| 99802BR | 3/16" Horseshoe Spacers Bag | 100 Qty | (12/cs) |

Tile Spacers

QEP / BRUTUS



made in
USA

- Precision cut for accuracy
- Evenly space tiles for uniform grout lines
- Provide quick, professional looking results
- Works with all sizes of ceramic tile, porcelain, stone and marble

| | | | |
|--------|------------------------|----------|---------|
| QEP | | | |
| 10006Q | 1/16" Tile Spacers Bag | 250 Qty | (24/cs) |
| 10281Q | 1/8" Tile Spacers Bag | 1000 Qty | (12/cs) |
| 10026Q | 1/8" Tile Spacers Bag | 250 Qty | (24/cs) |
| 10316Q | 3/16" Tile Spacers Bag | 200 Qty | (24/cs) |
| 10284Q | 3/16" Tile Spacers Bag | 500 Qty | (12/cs) |
| 10005Q | 1/4" Tile Spacers Bag | 200 Qty | (24/cs) |
| 10282Q | 1/4" Tile Spacers Bag | 400 Qty | (12/cs) |
| 10027Q | 3/8" Tile Spacers Bag | 100 Qty | (24/cs) |

| | | | |
|---------|------------------------|----------|---------|
| BRUTUS | | | |
| 82001BR | 1/16" Tile Spacers Bag | 250 Qty | (24/cs) |
| 82011BR | 1/16" Tile Spacers Bag | 1000 Qty | (12/cs) |
| 82002BR | 1/8" Tile Spacers Bag | 250 Qty | (24/cs) |
| 82006BR | 1/8" Tile Spacers Bag | 1000 Qty | (12/cs) |
| 82004BR | 3/16" Tile Spacers Bag | 200 Qty | (24/cs) |
| 82008BR | 3/16" Tile Spacers Bag | 500 Qty | (12/cs) |
| 82005BR | 1/4" Tile Spacers Bag | 200 Qty | (24/cs) |
| 82007BR | 1/4" Tile Spacers Bag | 400 Qty | (12/cs) |
| 82003BR | 3/8" Tile Spacers Bag | 100 Qty | (24/cs) |

Wedge Tile Spacers

QEP / BRUTUS



made in
USA

- Crucial for achieving a level first row of wall tile
- Ideal for maintaining level horizontal grout lines during installation
- Avoids tile slippage on vertical surfaces - will not compress

| | | | |
|--------|--------------------|---------|---------|
| QEP | | | |
| 10285Q | Wedge Tile Spacers | 500 Qty | (12/cs) |

| | | | |
|---------|--------------------|---------|---------|
| BRUTUS | | | |
| 82010BR | Wedge Tile Spacers | 500 Qty | (12/cs) |

Spacer Remover

TILEFORCE



- Removes tile spacers from adhesive or thinset before grouting
- Comfort grip

| | | |
|---------|----------------|---------|
| 82405TF | Spacer Remover | (10/cs) |
|---------|----------------|---------|



CARPET TOOLS

Power-Lok Stretcher

ROBERTS

The 10-254V Value Kit includes: one power unit, tail block with wheels, six 3 ft. extension tubes, adjustable locking tube, transfer tube and the complete interlocking wheeled stretcher carrying case and tube carrying case



The Power-Lok Stretcher is the most advanced power stretcher available.

- Power-Lok swivel head locks into 17 different “stretch/pattern holding” positions
- Unique swivel head for stretching angles or corners
- Variable pin penetration for different carpet thicknesses
- Low profile head with sidekicking platform makes it compatible with a knee-kicker
- Steel handle on head for better grip and repositioning
- Standard 18 in. tail block includes a foam wall protector and wheels for easy repositioning
- Stretch up to 38 ft. with the Value Kit and up to 23-1/2' with the standard set

The Power-Lok Stretcher is also available as a standard set

- A standard 10-254 set includes: one power unit, tail block with wheels, three 3 ft. extension tubes, adjustable locking tube, transfer tube, and the single interlocking wheeled stretcher carrying case

| | |
|-----------|--|
| 10-254V | Power-Lok Stretcher Value Kit (1/cs) |
| 10-254 | Power-Lok Stretcher (1/cs) |
| 10-254-50 | Replacement Power Head for 10-254 (does not include tube, tail block or carrying cases) (1/cs) |

Included with each stretcher! No. 10-250 Adjustable Locking Tube

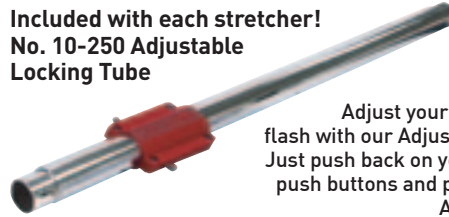

Adjust your stretcher poles in a flash with our Adjustable Locking Tube! Just push back on your tubes to extend, push buttons and pull back to shorten. Also sold separately.

Additional Stretcher Tubes

ROBERTS

- Fits all standard Roberts Stretchers as well as most other standard carpet stretchers

| | |
|-----------|--|
| 10-250 | Adjustable Locking Tube (1/cs) |
| 10-230-10 | 3' Steel Stretcher Tube Fits 10-254 & 10-237 Stretchers (1/cs) |
| 10-235-10 | 3' Aluminum Stretcher Tube (not shown) (1/cs) |
| 10-235-05 | 5' Aluminum Stretcher Tube (not shown) (1/cs) |

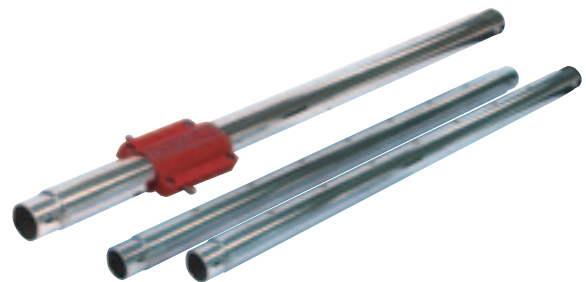

3' Stretcher Tube Carrying Case

ROBERTS

- Holds 6 tubes, aluminum or steel
- Made of ballistic nylon with extra padding
- Heavy duty zipper, shoulder strap and carry handle

| | |
|--------|--|
| 10-232 | 3' Stretcher Tube Carrying Case (1/cs) |
|--------|--|



Junior Power Stretcher

ROBERTS

The 10-237V Value Kit includes: one power unit, tail block with wheels, six 3' extension tubes, adjustable locking tube, transfer tube and the complete interlocking wheeled stretcher carrying case and tube carrying case



Our most economical power stretcher is loaded with features.

- The low profile power head is easy to span with the knee kicker
- 18 in. spring-loaded tail block with wheels provides additional support
- Stretch over 38' with the Value Kit and up to 23-1/2' with the standard set

The Junior Power Stretcher is also available as a standard set.

- A standard 10-237 set includes: one power unit, tail block with wheels, three 3' extension tubes, adjustable locking tube, transfer tube, and the single interlocking wheeled stretcher carrying case

Included with each stretcher!
No. 10-250 Adjustable
Locking Tube

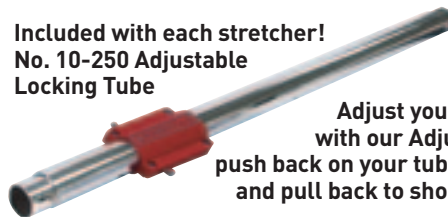

Adjust your stretcher poles in a flash with our Adjustable Locking Tube! Just push back on your tubes to extend, push buttons and pull back to shorten. Also sold separately.

| | |
|-----------|---|
| 10-237V | Junior Power Stretcher Value Kit (1/cs) |
| 10-237 | Junior Power Stretcher (1/cs) |
| 10-237-50 | Replacement Power Head for 10-237 (does not include tube, tail block or carrying cases) (1/cs) |

Stretcher Cases

The Roberts Stretcher Case System includes a stretcher case with wheels and a tube case that hooks onto the stretcher case for easy transportation. The cases are easily split apart to equally distribute the weight when carrying to and from the jobsite. Both cases include high-density blow molded plastic walls for exceptional durability, recessed hinges and latches and comfortable molded handles.



10-230-40

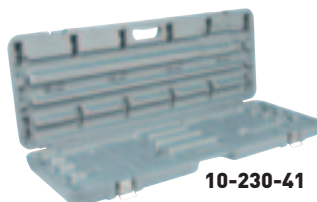

10-230-41

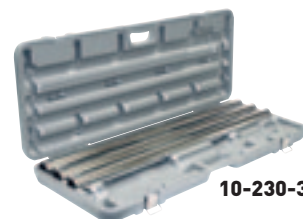

10-230-3K

- Stretcher Case with 4" Wheels holds stretcher unit, tail block with wheels, three 3 ft. extension tubes, adjustable locking tube and transfer tube (nylon web belt with quick release buckle included)
- For use with 10-254 and 10-237 stretchers

| | |
|-----------|--|
| 10-230-40 | Empty Stretcher Case with Wheels (1/cs) |
| 10-230-41 | Empty Tube Case (holds four 3' tubes) (1/cs) |
| 10-230-3K | Tube Case with Three 3' Extension Tubes (1/cs) |

Locking Pattern Matching & Seam Repair Stretcher

ROBERTS

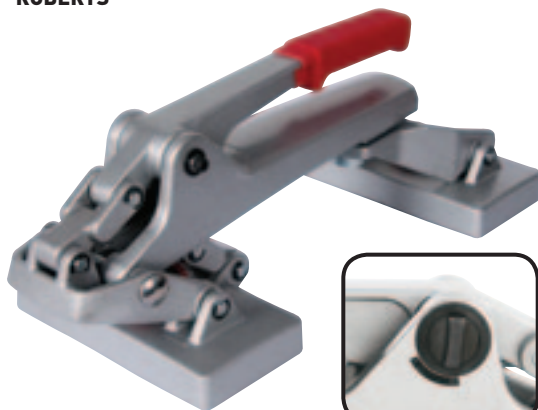

ON/OFF knob provides locking or conventional operation



INCLUDES: Tailblade for stretching carpet off of tackstrip



The unique locking action enables "hands-off" seam repair. Turn the Automatic Locking Mechanism "ON" and the powerhead locks each 1/4" of pin plate travel for easy pattern alignment. Turn the locking action "OFF" and the stretcher works in the conventional "non-locking" mode.

- Adjustable pin depths for different carpet thicknesses
- Holds up to 300 lbs. of stretch tension
- Tailblade swivel construction allows for angle stretching in any direction off of tackstrip
- Solid die cast frame stands up to years of dependable service
- Includes custom molded carrying case

| | | |
|-----------|--|--------|
| 10-128 | Locking Pattern Matching and Seam Repair Stretcher | (1/cs) |
| 10-117-04 | Powerhead Replacement Unit | (1/cs) |
| 10-107-03 | Tailblade Replacement Unit | (3/cs) |
| 10-117-05 | Replacement Blow Molded Carrying Case | (1/cs) |

Nap Grip Head (Cotton Head)

ROBERTS

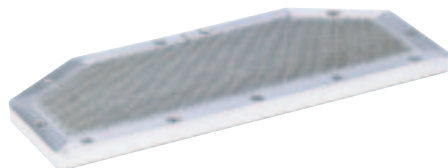

- Designed to use on low profile loop, cut pile and woven carpets

| | | |
|--------|--|--------|
| 10-248 | Nap Grip Head for 10-254 and 10-237 stretchers | (1/cs) |
|--------|--|--------|

Power Stretcher Tail

ROBERTS



- Needle sharp point bites through carpet and pad into wood subfloor for a firm solid stretch
- Stretch even when there are no walls to brace against
- Precision made with hand-ground tempered steel
- Fits all standard Roberts Stretchers

| | | |
|--------|----------------------|--------|
| 10-258 | Power Stretcher Tail | (1/cs) |
|--------|----------------------|--------|

Carpet Spreader

ROBERTS



- Tucks carpet neatly into gully while power stretching
- Comfortable hardwood handle
- Solid steel blade with tapered edges will not catch or pull carpet face yarn

| | | |
|--------|-----------------|---------|
| 10-562 | Carpet Spreader | (10/cs) |
|--------|-----------------|---------|

Gel Pro 505 Knee Kicker

ROBERTS

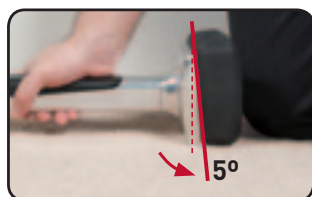

- Innovative lever design for easy pin depth adjustment
- Gel bumper softens impact to knee, reducing knee shock
- Angled bumper provides optimum driving impact
- Contoured, heavy duty "bullneck" body design
- Quick thumb release for adjusting the extension arm
- Comfort pad insert

10-505 Gel Pro 505 Knee Kicker (3/cs)

10-505-200 Bumper Pad Kit (Bumper, Plate, Boot, Gel Pad) (1/cs)



GT2000 XL Knee Kicker

ROBERTS



- Scientifically engineered bumper pad significantly reduces knee shock
- 28% wider head than standard kickers provides 33% more gripping power
- Trigger easily adjusts the length from 18½" to 22½"
- Thick walled, aluminum die cast body for maximum strength
- High contour neck fits over stretcher
- Center grooved head for adjusting power stretcher head
- Smooth, precise dial adjustments

10-2000GT GT2000 XL Knee Kicker (3/cs)

10-2000-09 Replacement Bumper Pad (3" thick) (1/cs)

GT Knee Kicker

GOLDEN TOUCH



- Easy one button adjustments from 18-7/8" to 24" lengths
- Extra wide head for improved load distribution
- High contour neck for use over stretcher head and poles
- Center grooved head for adjusting power stretcher head
- Easy to read, easy to adjust pin depth dial

10-501 GT Knee Kicker (3/cs)

10-412-09 Replacement Bumper Pad (2" thick) (1/cs)

10-2000-09 Replacement Bumper Pad (3" thick) (1/cs)

Deluxe Knee Kicker

ROBERTS



The 10-412 Deluxe Knee Kicker is Roberts' most popular knee kicker and has been the "industry standard" for over 25 years.

- Trigger assembly easily adjusts the length from 17" to 21"
- Superior die cast aluminum body is lightweight and durable
- Exclusive non-slip checkered hand grip
- Foam-filled seamless bumper pad for extra comfort
- Easy to read, easy to adjust pin depth dial
- Center grooved head for adjusting power stretcher head

| | |
|------------|--|
| 10-412-2 | Deluxe Knee Kicker (no case) (2/cs) |
| 10-412BKK | Deluxe Knee Kicker (black finish with case) (3/cs) |
| 10-412-22 | Optional Molded Carrying Case (1/cs) |
| 10-412-09 | Replacement Bumper Pad (2" thick) (1/cs) |
| 10-2000-09 | Replacement Bumper Pad (3" thick) (1/cs) |

Deluxe High Profile Knee Kicker

ROBERTS



The 10-422BK features the same solid construction and reliability of the 10-412 but with the added value of a number of installer-designed features.

- High contour neck for use over stretcher head and poles
- 50% thicker bumper pad for extra knee comfort
- 16% wider head for improved load distribution
- Solid, dependable trigger release adjusts from 17-1/2" to 21-1/2"
- Non-slip checkered hand grip
- Center grooved head for adjusting power stretcher head

| | |
|------------|--|
| 10-422BK | Deluxe High Profile Knee Kicker (3/cs) |
| 10-412-09 | Replacement Bumper Pad (2" thick) (1/cs) |
| 10-422-09 | Replacement Thick Bumper Pad (3" thick) (1/cs) |
| 10-2000-09 | Replacement Bumper Pad (3" thick) (1/cs) |

Adjustable Knee Kicker

ROBERTS



- Great for all carpeting installations - big or small
- Double locking pins to easily adjust length from 19" to 23"
- Extra heavy aluminum casting and industrial grade steel provide rugged strength
- High contour neck for use over stretcher head and poles
- Center grooved head for adjusting power stretcher head
- Easy to read, easy to adjust pin depth dial
- Durable powder coated finish

| | |
|------------|--|
| 10-410 | Adjustable Knee Kicker (3/cs) |
| 10-412-09 | Replacement Bumper Pad (2" thick) (1/cs) |
| 10-2000-09 | Replacement Bumper Pad (3" thick) (1/cs) |

SharkTeeth Knee Kicker Grips

ROBERTS

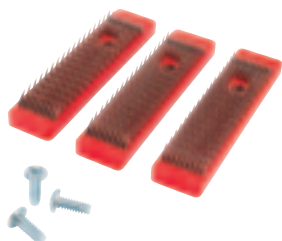

Give your kicker maximum "Bite". Upgrade to stronger pins or replace old, worn out pins. The hardened stainless steel blades last 5 times longer than conventional nap grips. The long pins penetrate deep into pile to positively grip all carpet types.

- Fits all knee kickers with single screw nap grips
- Easy to clean, hardened stainless steel blades will not bend
- One set of three per bag

| | |
|--------|--|
| 10-245 | SharkTeeth Knee Kicker Grips 3 Pack (1/cs) |
|--------|--|

Cool Shield® Heat Bond Iron

ROBERTS



The Cool Shield Heat Bond Iron melts 3" wide heat bond tape quickly and easily while maintaining a cooler top shield temperature. Even on the highest setting of 425°F the 10-482G reaches a maximum heat shield temperature of only 256°F.

- Patented double heat shield minimizes deforming of carpet backing and face yarn
- "S" shaped heating element provides even heating and longer heat retention
- Grooved non-stick base for fast, easy clean-up
- "Comb Profile" forms ridges in adhesive for stronger carpet seams
- Streamlined, low profile design allows for easy carpet seaming
- 3-way cord guide keeps the 9-1/2' cord out of the way
- Thermostat indicator light shows when iron is heating

10-482G Cool Shield Heat Bond Iron (110 V) (2/cs)
10-483G Cool Shield Heat Bond Iron (220 V Special Order) (3/cs)

Deluxe Heat Bond Iron

ROBERTS



This best selling Heat Bond Iron is the first choice of professionals worldwide.

- Streamlined, low profile design allows for easy carpet seaming
- Even heat distribution for thorough melting
- Heat shield to prevent backings from overheating
- Non-stick coated for fast, easy clean-up
- "Comb Profile" forms ridges in adhesive for stronger carpet seams
- 3-way cord guide keeps cord out of the way
- Stay-cool handle and up-front thermostat make it easy to use
- Approximate heat range 135°F to 425°F

10-282G-2 Deluxe Heat Bond Iron, Grooved Base (110 V) (2/cs)
10-283 Deluxe Heat Bond Iron (220 V Special Order) (3/cs)

6" Heat Bond Iron

ROBERTS



Get faster, more thorough bonding even near walls or in doorways.

- Custom designed to distribute heat evenly from front to tail
- Special contoured handle stays cool
- Grooved non-stick base for fast, easy clean-up
- Up-front thermostat control for easy heat-setting adjustments
- Low profile, tapered base plate design for joining carpet easily at the back of the iron
- 3-way cord guide keeps cord out of the way
- Approximate heat range 135°F to 425°F
- 110 V

10-286G 6" Heat Bond Iron, (110 V) (3/cs)

Seam Adhesive Dispenser

ROBERTS



Roberts 10-145 is an empty seam adhesive applicator bottle used for dispensing seam sealing products, such as Roberts 8015 Universal Carpet Seam Sealer.

- Convenient applicator nozzle is designed to apply seam sealer to carpet backs
- Holds 8 oz. of seam sealer

10-145 Seam Adhesive Dispenser (25/cs)

4" Loop Pile Seam Roller

ROBERTS



- Extended, angled soft grip handle for better leverage
- Specifically designed for seaming loop pile and berber carpets
- Star wheels maximize hot melt transfer into carpet back for stronger seams
- Excellent for hooking carpet on tackstrip

10-169 4" Loop Pile Seam Roller (3/cs)

Carpet Seam Roller

ROBERTS



- Specially designed for loop pile carpet
- Wide head reduces dishing in seam area
- Durable and lightweight superior die cast handle
- Get stronger seams and increased hot melt transfer into carpet back with stationary roller shaft

10-100 5" Extra Wide Carpet Seam Roller (3/cs)
10-105 3" Carpet Seam Roller (6/cs)

4½" Deluxe Carpet Seam Roller

ROBERTS



- Specially designed for loop pile carpet
- Professionally finishes even the most demanding carpet seams
- No-slip handle and lightweight design to minimize user fatigue
- Offset, extra wide 4-1/2" rollers to reduce seam peaking and maximize adhesive penetration for stronger, longer lasting seams

10-101 4½ in. Deluxe Carpet Seam Roller (4/cs)

4" Cut Pile Seam Roller

ROBERTS



- Extended, angled soft grip handle for better leverage
- Smooth roller forces carpet backing into seaming tape without fraying yarn ends
- Specifically designed for safe seaming of cut pile carpets, saxonomies and vinyl seams

10-170 4" Cut Pile Seam Roller (3/cs)

3½" Solid Wheel Carpet Seam Roller

ROBERTS

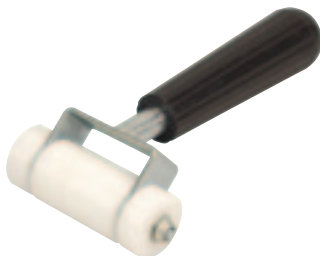

- Smooth roller is specifically designed for safe seaming of cut pile carpets and saxonomies
- Reduce "pocking" and deformation of carpet yarn with solid nylon rollers
- Specially designed handle for optimum leverage

10-106-3 3½" Solid Wheel Carpet Seam Roller (3/cs)

GT ONE STEP Carpet Trimmer

GOLDEN TOUCH



- Secures, cuts and tucks carpet in one easy step
- Easily cuts a variety of carpet thicknesses with the adjustable blade guide
- Roller system tucks carpet into gully
- 2 in. star rollers secure carpet to tackstrip
- Use with knee kicker or stretcher and speed up installation

10-621GT GT ONE STEP Carpet Trimmer (3/cs)
Uses replacement blades: 10-388, 10-444

Conventional Carpet Trimmer

ROBERTS / GOLDEN TOUCH

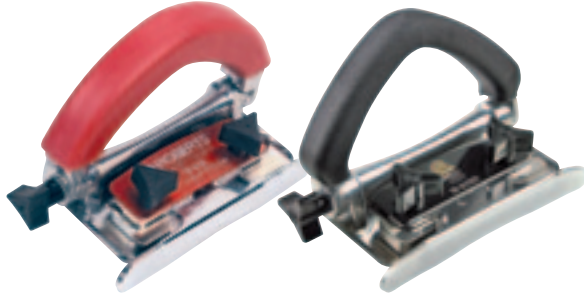

- Quickly trims carpet neatly at the wall and under toe kicks
- Five position folding handle moves easily in hard to reach areas
- Quick and positive vertical and horizontal adjustment
- Anti-slip rubber handle and hardened stainless steel guide
- 10-617GT includes dual layer spring steel blade clips

10-616-2 Carpet Trimmer (Includes 20 Heavy Duty Slotted Blades) (2/cs)
10-617GT GT Carpet Trimmer (Classic Handle) (2/cs)
10-906 Carpet Trimmer Adapter (4/cs)
Uses replacement blades: 10-388, 10-444

Multi-Purpose Wall Trimmer

ROBERTS / GOLDEN TOUCH



This Multipurpose Wall Trimmer is not only good for cutting conventional carpet, it is great for cutting soft vinyl sheet goods, carpet tiles and cushion back for glue-down carpets.

- Make cleaner cuts without marking walls
- Hooked blades can be used to cut carpet tiles quickly and easily
- Slotted blades can be used for regular carpet or vinyl sheet goods
- Snap-on anti-friction boot glides smoothly over sheet goods
- Fully adjustable for most material thicknesses
- Stainless steel construction

10-905 Multipurpose Wall Trimmer (3/cs)
Uses replacement blades: 10-440, 10-436, 10-438

Loop Pile Cutter

ROBERTS / GOLDEN TOUCH

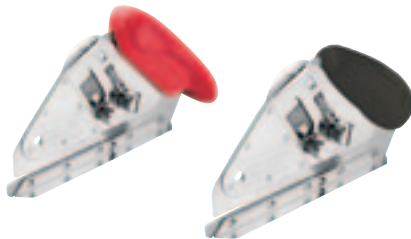

- Efficiently cuts most loop pile carpet regardless of thickness
- Unique two-blade design accommodates both left and right positions for cutting closer to the yarn edge
- "Direct Contact" locking design keeps blades securely in place
- Throat opening adjusts automatically for different carpet backs
- Constructed of stainless steel for maximum durability

10-152-3 Loop Pile Cutter (Includes 15 Heavy Duty Slotted Blades) (3/cs)
10-152GT Loop Pile Cutter (Classic Handle) (6/cs)
Uses replacement blades: 10-436, 10-438

Cushion Back Cutter

ROBERTS / GOLDEN TOUCH



- Cut all thicknesses of cushion back carpet and conventional carpet with adjustable blade depth
- Two blades that lock into position for close, precise cutting
- Direct-pressure blade knob holds blades tightly in place
- Constructed of stainless steel for maximum durability

10-146-3 Cushion Back Cutter (Includes 15 Heavy Duty Slotted Blades) (3/cs)
10-146GT Cushion Back Cutter (Classic Handle) (4/cs)
Uses replacement blades: 10-436, 10-438

Cushion Back Cutter with Row Finder

ROBERTS



- Same features as the 10-146-3 with the added benefit of patented row finder attached
- Quick and easy method to find the row and cut in one time-saving motion
- Includes 15 Heavy Duty Slotted Blades

10-147 Cushion Back Cutter with Row Finder (3/cs)
Uses replacement blades: 10-436, 10-438

Universal Seam Cutter

ROBERTS



- Single center mechanism holds both slotted and utility blades in place
- Superior double usage - use slotted blade for top cutting or trimmer blade for bottom cutting
- 50° blade angle permits cleaner, smoother precise cuts
- Quick release blade replacement feature for fast blade changes
- Extra long nose provides for better row separation
- Accepts all standard utility blades

10-154-3 Universal Seam Cutter (3/cs)
Uses replacement blades: 10-388, 10-436, 10-438

Row Finder/Separator

ROBERTS



- Use to separate carpet rows to minimize damage to nap and loops
- Features tapered round end for cut pile and flattened end for loop pile carpets
- Slip resistant checkered grip

10-517 Row Finder Separator (6/cs)

EZ TUK Carpet Tucker

ROBERTS



made in
USA

- Lightweight tucking tool will not mark or damage walls
- Use around toilets and ceramic tile without fear of breakage
- Square edge works well for tucking carpet into corners
- Curved edge is great for stairs
- 3-1/2 in. wide blade

10-522-4 EZ TUK Carpet Tucker (4/cs)

Stair Tools

ROBERTS



- Use to set carpet into tack strip, drive carpet into gullies and crease carpet along wall line
- Heavy duty blade easily sets carpet into stairway crevices
- Made from forged, chrome-plated steel

10-521 3-1/2" Extra Wide Stair Tool (3/cs)
10-520 2-3/4" Stair Tool (12/cs)

Turning Tools

ROBERTS



- Hundreds of uses for both tools. 10-136 is ideal for tucking carpet at baseboards as well as use for upholstery work.
- Cushion grip adds comfort to utility
- Precision ground shaft of tempered steel. The last inch of 10-136 shaft is bent at a 30° angle

10-135 4" Awl (6/cs)
10-136 Turning Tool (6/cs)

Longneck Plus 6" Jamb Saw

ROBERTS



*hose not included

- 1-1/2" vacuum port for optimal dust containment
- Extended "tail" for maximum leverage against torque
- Powerful, 1100 watt industrial grade power unit, 120 V
- Patented design enables saw to cut full inside corners in molding up to 1/2" thick
- Adjustable cutting depth guide prevents cutting into plaster or wall board when trimming base boards
- Easy access trigger for better control
- Precision height adjustment from "flush" to 1-1/16"
- Doors as thick as 1-3/4" can be undercut without removal
- Includes 6-3/16 in. 36-tooth carbide tip blade and masonry blade
- Includes custom molded carrying case

| | | |
|----------|--|--------|
| 10-56 | Longneck Plus 6" Jamb Saw | (1/cs) |
| 10-47-2 | 6-3/16" 36-Tooth Carbide Tip Saw Blade | (2/cs) |
| 10-47-6 | 6-3/16" 20-Tooth Carbide Tip Saw Blade | (6/cs) |
| 10-55-24 | Masonry Blade | (1/cs) |

Super Six 6" Jamb Saw

ROBERTS



- Adjustable cutting depth guide prevents cutting into plaster or wall board when trimming base boards
- Powerful, 900 Watt industrial grade power unit has all ball and needle bearings, 120 V
- Patented design enables saw to cut full inside corners in molding up to 1/2" thick
- Spiral ground gears for smooth, quiet operation
- Precision height adjustment from "flush" to 1-1/16"
- Doors as thick as 1-3/4" can be undercut without removal
- Includes 6-3/16" 36-tooth carbide tip blade
- Includes custom molded carrying case

| | | |
|---------|---|--------|
| 10-46 | Super Six 6" Jamb Saw | (1/cs) |
| 10-47-2 | 6-3/16 in. 36-Tooth Carbide Tip Saw Blade | (2/cs) |
| 10-47-6 | 6-3/16 in. 20-Tooth Carbide Tip Saw Blade | (6/cs) |

Jamb Saw Replacement Blades

ROBERTS

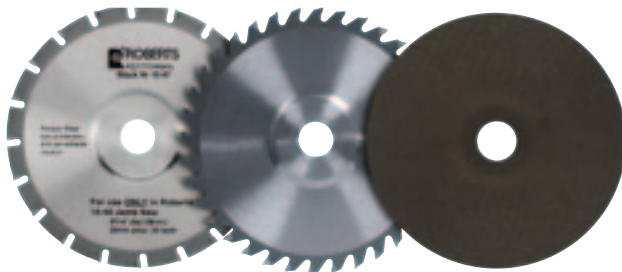

- 10-47-6 Carbide tipped blades provide long cutting life 20-tooth anti-snag blade resists catching on hidden nails (6/cs)
- 10-47-2 36-tooth carbide tipped blade easily cuts through tough wood. Excellent for cutting door jams, baseboards and along walls (2/cs)
- 10-55-24 Durable masonry blade easily cuts through brick and cement block (1/cs)

Professional Electric Stapler

ROBERTS



- Powerful, 15 amp solenoid delivers more power to drive staples deeper, 120 V
- 6-3/4" low profile head allows easy access in tight places, particularly stairs
- Heavy 14 gauge, 12' power cord offers maximum power and provides a wider range of travel without extension cords
- Hardened driver mechanism that shoots 20 gauge,
- 3/16" crown staples
- Quick-release bottom loading magazine for fast reloading (85 staple capacity)
- Ergonomic non-slip handle with rubber grip for maximum comfort and control
- Includes custom molded carrying case
- Accepts Duo-Fast® #5418-D Staples and other quality brand 9/16" divergent Point Staples

10-600 Professional Electric Stapler (1/cs)

All-Purpose Hammer Tacker

ROBERTS



- Heavy duty, precision built
- Shock absorbing, non-slip rubber grip
- Accepts staple lengths from 1/4" to 9/16" and crown widths from 3/8" to 1/2"
- Ideal for carpet installation, roofing, insulation, house wrap, poly sheeting and upholstery

10-112 All-Purpose Hammer Tacker (3/cs)

Staple Hammer

ROBERTS



- Perfect balance, durable stamped steel, comfortable vinyl grip, and easy back-end loading
- Accepts 3/8 in. staples
- Holds 160 staples

10-109 Staple Hammer (6/cs)
 30-210 3/8" Divergent Point Staples 5000/bx (20/cs)
 30-110 3/8" Chisel Point Staples 5000/bx (20/cs)

Nail Driving Bar

ROBERTS



- Constructed of cold forged carbon steel for an extra long life
- Features a magnetic head to hold nails in place for easy starting
- Unique design to access hard-to-reach places such as: under radiators, toe kicks, overhangs and next to glass doors when nailing down tackless strip
- 12-3/8" in length, with soft, no-slip handle

10-151 Nail Driving Bar (6/cs)

10" Carpet Shears

ROBERTS



made in
USA

- Precision ground cutting blades
- Superior cutting ability and durability
- Accommodates large hands comfortably with extra wide, vinyl coated cushioned handle openings
- Blade edge sharpens easily on stone
- Chrome plated with knife edges

10-123 10" Carpet Shears (6/cs)

8" Napping Shears

ROBERTS



made in
USA



Side angle profile

- Offset handle for easy, level napping
- Cushioned, vinyl coated handles for comfort
- Precision ground cutting blades
- Chrome plated with knife edges

10-121 8" Napping Shears (6/cs)

6" Duckbill Napping Shears

ROBERTS



made in
USA



Side angle profile

- Offset handle and special blade prevent gouging while napping
- Cushioned, vinyl coated handles for comfort
- Precision ground cutting blades
- Chrome plated with knife edges

10-585 6" Duckbill Napping Shears (6/cs)

7" Duckbill Napping Shears

ROBERTS



made in
USA



Side angle profile

- Offset handle and special blade prevent gouging while napping
- Cushioned, vinyl coated handles for comfort
- Precision ground cutting blades
- Chrome plated with knife edges

10-586-3 7" Duckbill Napping Shears (3/cs)

30' Tape Measure

ROBERTS



- 30' x 1" steel acrylic coated blade
- Rugged case with red rubber jacket
- Bright colors for "easy to find" visibility
- Strong spring return; thumb lock and steel belt clip

10-140 30' Tape Measure (12/cs)

16" Seaming Iron Case

ROBERTS



- Designed to hold two irons and a roll of standard seaming tape
- Shelf holds a standard seam iron, bottom holds a 6" seam iron
- Shelf is conveniently hinged to allow easy access to the bottom
- Full-length piano hinge, latch and powder-coat paint finish for superior scratch and chemical resistance
- 16" W x 9-1/2" H x 9-1/2" D

10-162 16" Seaming Iron Case (1/cs)

24" Steel Tool Box

ROBERTS

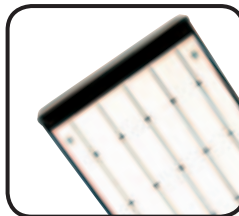

Seaming Plate



Staple Storage

- Heavy duty steel construction
- Durable full length piano style hinge
- Strong side handles and durable soft grip lid handle for easy carrying
- Vented nylon seaming plate mounted under tray acts as seaming weight
- Tray provides extra storage for staple and nail boxes
- 3 hardened steel hasps provide secure closure and accept padlocks for additional security
- 24" W x 9-3/4" H x 8-3/4" D

10-161 24" Steel Tool Box (1/cs)

Carpet Installation Kit

ROBERTS



Carpet Installation Kit Includes:

| | |
|----------|-------------------------------------|
| 10-161 | 24" Steel Tool Box |
| 10-169 | Loop Pile Seam Roller |
| 10-108 | Professional 2 in. Strip Cutter |
| 10-112 | All Purpose Hammer Tacker |
| 10-114 | 20 oz. Ripping Hammer |
| 10-146GT | GT Cushion Back Cutter |
| 10-151 | Nail Driving Bar |
| 10-152GT | GT Loop Pile Cutter |
| 10-252 | Professional Carpet Knife |
| 10-261 | Leather Tool Pouch |
| 10-303S | Thriftline Chalk Reel |
| 10-321 | White Chalk Refill - 8 oz. |
| 10-412-2 | Deluxe Knee Kicker |
| 10-510-3 | Base Molding Lifter |
| 10-521 | 3-1/2' Extra Wide Stair Tool |
| 10-522-4 | EZ Tuk Carpet Tucker |
| 10-586-3 | 7" Duckbill Napping Shears |
| 10-616-2 | Conventional Carpet Trimmer |
| 10-920-6 | Pro Fixed Blade Utility Knife |
| 10-931 | Linoleum Knife |
| 10-140 | 30' Tape Measure |
| 10-517 | Row Finder/Separator |
| 61613 | Rubber Mallet |
| 10-750 | Carpet Installation Tool Kit (1/cs) |

Economy Carpet Installation Kit

ROBERTS



Carpet Installation Kit Includes:

| | |
|----------|--------------------------------|
| 10-154-3 | Universal Seam Cutter |
| 10-169 | 4" Loop Pile Seam Roller |
| 10-252 | Professional Carpet Knife |
| 10-521 | 3-1/2" Extra Wide Stair Tool |
| 10-586-3 | Duckbill Napping Shears |
| 10-751 | Carpet Installation Kit (1/cs) |

Deluxe Grip Pouch

ROBERTS



- Holds tools firmly in place with special leather insert grips
- Professionally constructed of 100% leather and double stitching
- Slotted to fit directly on the belt
- 7-1/2" x 4-1/2" x 3/4"

10-260 Deluxe Grip Pouch (12/cs)

Leather Tool Pouch

ROBERTS



- Sturdy 100% leather with double stitching
- Ideal for carrying knives and other tools
- Slotted to fit directly on the belt
- 7-1/2" x 4-1/2" x 3/4"

10-261 Leather Tool Pouch (12/cs)

Deluxe Hot Melt Glue Gun

ROBERTS



- 100 Watts at 400°F
- Works twice as fast as conventional glue guns
- Double powered solid state heater warms up in just 3 minutes
- Extrudes up to 2 lbs. of glue per hour
- Fits easily into carpet seams and hard-to-reach areas with its extra long nozzle
- Spring-loaded trigger eliminates glue back-up and gun damage

10-800 Deluxe Hot Melt Glue Gun (1/cs)

Hot Melt Glue Gun

ROBERTS



- Solid state heating system warms up in just 3 minutes
- Silicone feed sleeve provides smooth application
- Extrudes up to 1 lb. of glue per hour
- Specially designed trigger with feed pressure limiter eliminates glue back-up and gun damage
- 40 Watts at 380°F
- Includes 6 glue sticks (4" long and 1/2" in diameter)

10-700 Hot Melt Glue Gun (6/cs)

Glue Sticks

ROBERTS



- Excellent for most carpet and sheet goods excluding vinyl backs
- Make repairs disappear with our translucent hot melt glue stick that cools almost clear
- 1/2" diameter fits most glue guns

10-801 10" Glue Sticks, 22 lb. bulk pack (Approx. 378 sticks per box)
10-802 10" Glue Sticks (12 sticks per box)

Multipurpose Trim Shears

ROBERTS



- Easily cuts tile trim, PVC piping, quarter round, tackstrip and other light materials
- Attached miter guide for precise cutting of angles
- Pre-notched guide at 45°, 60°, 75°, 90°, 105° and 120°

10710 Multipurpose Trim Shears (6/cs)

Professional 2" Strip Cutter

ROBERTS



- Long jaws cut all strip, including architectural strip
- Powerful cutting force - 8 to 1 leverage
- Rugged, forged steel construction
- Blade storage in handle

10-108 Professional 2" Strip Cutter (3/cs)
Uses replacement blades: 10-439

10" Aviation Snips

ROBERTS



- Extra powerful compound leverage allows effortless metal cutting
- Serrated blades prevent slip-out
- Cut notches and shallow curves as well as straight cuts
- Vinyl covered handles for comfort

10-274 10" Aviation Snips (1/cs)

Heavy Cargo Dollies

ROBERTS

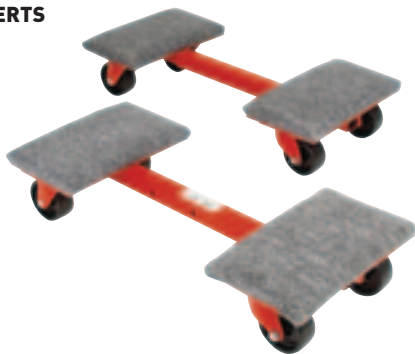

- These rugged, durable movers are perfect for moving rolls of carpet or sheet goods, equipment, furniture and appliances
- Each dolly holds up to 1000 pounds
- Made from heavy industrial steel, with welded and bolted construction
- Easily extends from 24" to 33" with spring loaded lock pins
- 3" heavy-duty ball bearing non-mar polyurethane wheels

10-575 Heavy Cargo Dollies set of 2 (1/cs)

Karpet Kart

ROBERTS



- Super tough heavy gauge tubular steel and all welded construction
- Features 16" pneumatic tires
- 1000 pound capacity
- 61" L x 20-1/4" W x 18-1/2" H

10-227 Karpet Kart (1/cs)
10-227-02A Karpet Kart Replacement Wheels (1/cs)

Dual Air Glider

ROBERTS

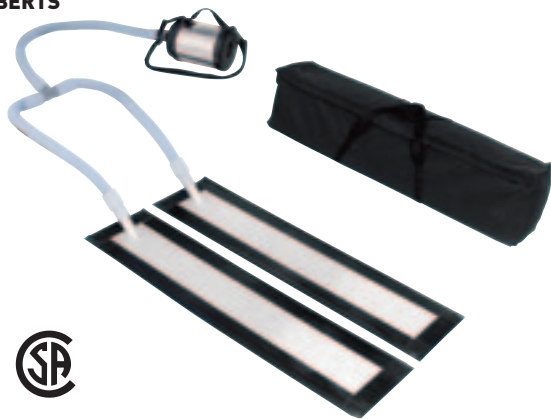

- A powerful, lightweight mechanism which utilizes hovercraft principles for easy and safe movement of commercial and industrial machinery, office equipment and household appliances without damaging floors
- 8-1/2" x 36" dual vacuum platforms
- 1.75 HP blower provides a 750 lbs. lift capacity
- Improved motor output connector
- Includes carrying case

10-480 Dual Air Glider (1/cs)



E•Z Slides

ROBERTS

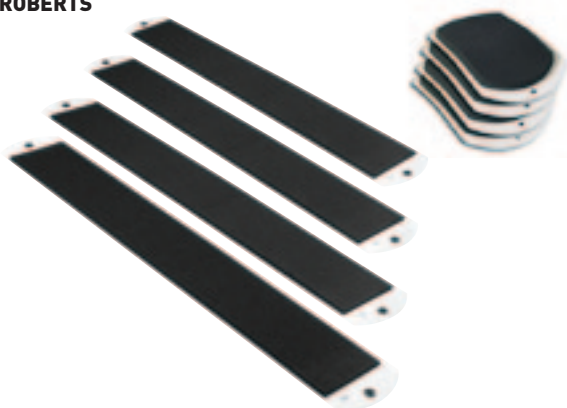

- Helps easily move heavy furniture and appliances
- Super slick high density plastic slides have closed-cell, non-skid foam pads
- Includes heavy-duty metal grommets for pulling

10-50 Set of 2 slides: 6-3/4" wide x 48" long (1/cs)
10-51 Set of 4 slides: 6-3/4" wide x 11-1/2" long (not shown) (1/cs)



LAMINATE & WOOD TOOLS

Porta-Jack Pro Hardwood Flooring Jack

PORTA-NAILS

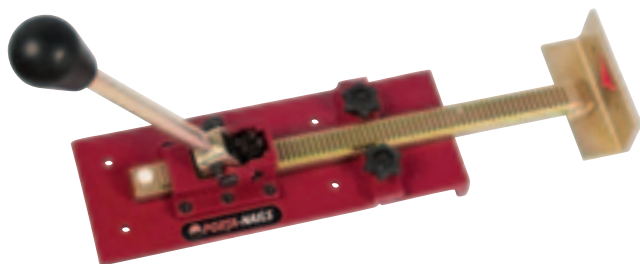

Applications

- Solid & engineered wood flooring
- Tightens and holds flooring strips in place for nailing
- Versatile features allow use up against walls or in the middle of the floor
- Straightens crooked or bowed flooring strips
- 'Non-stick' coated base provides protection for prefinished floors
- Includes 2 knob screws for easy front lip removal
- Delivers over one ton of force

47100 Porta-Jack Pro Hardwood Flooring Jack (1/cs)

25" Pro Laminate Cutter

ROBERTS



Applications

- Carpet Tile
- Laminate & Engineered Wood Flooring
- Vinyl Flooring
- Vinyl Sliding
- VCT Tile
- Rubber
- Foam
- PVC and more
- Cuts Carpet Tile, Wood Planks and flooring up to 25" wide 17" diagonal and 1/2" thick
- Extendible handle provides extra leverage for more cutting power with less effort
- Cutting guide swivels for angle cuts and is adjustable to maintain perfect 90° cuts
- Replaceable, resharpenable 4mm thick tungsten blade

10-68 25" Pro Laminate Cutter (1/cs)
10-468 25" Tungsten Carbide Rep. Blade (1/cs)

18" Pro Laminate Cutter

ROBERTS

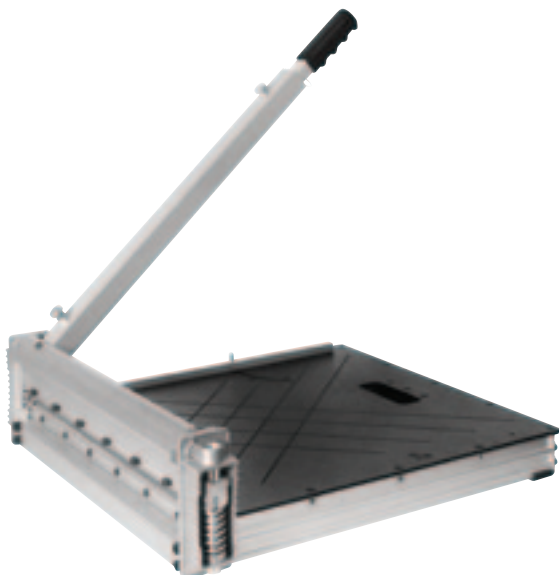

Applications

- Laminate & Engineered Wood Flooring
- Vinyl Flooring
- Vinyl Sliding
- VCT Tile
- Parquet
- Rubber
- Foam
- PVC and more
- Cuts up to 18" planks, 12" diagonal and 5/8" thick
- Extendible handle provides extra leverage for more cutting power with less effort
- Cutting guide swivels for angle cuts and is adjustable to maintain perfect 90° cuts
- Replaceable, resharpenable 4mm thick tungsten blade

10-66 18" Pro Laminate Cutter (1/cs)
10-466 18" Tungsten Carbide Rep. Blades (1/cs)

13" Pro Flooring Cutter

ROBERTS



Applications

- Parquet
- Vinyl Flooring
- Vinyl Siding
- VCT Tile
- Rubber
- Foam
- PVC and more

- Extendible handle provides extra leverage for more cutting power with less effort
- Guide swivels for angle cuts
- Heavy duty extruded aluminum base with thick plastic surface
- Replaceable, resharpenable 4mm thick blade
- Cuts up to 13" wide, 8" diagonal and 5/8" thick material

10-64 13" Pro Flooring Cutter (1/cs)
10-464 13" Tungsten Carbide Replacement Blade (1/cs)

9" Flooring Cutter

ROBERTS



Applications

- Laminate & engineered wood flooring
- Heavy duty steel "T" base design for maximum stability
- Extra long handle for better cutting leverage
- Long lasting 9", resharpenable 4mm tungsten blade
- Versatile angle guide for 45° cuts
- Sturdy, positionable "V" support keeps planks level while cutting

10-60 9" Flooring Cutter (1/cs)
10-460 9" Tungsten Carbide Replacement Blade (1/cs)

| PLANK WIDTH | MAX CUTTING THICKNESS |
|-------------|-----------------------|
| 5½" | up to 5/8" thick |
| 7" | up to 1/2" thick |
| 8½" | up to 3/8" thick |

8" Laminate Cutter

ROBERTS



- Cuts laminate up to 8" wide and 10mm thick
- Heavy duty steel frame for maximum stability
- Positionable "V" support keeps planks level while cutting

10-35 8" Laminate Cutter (1/cs)

Porta-Nailer Hammerhead

PORTA-NAILS



- 5/8", 3/4" & 33/32" domestic solid wood flooring
- 3/8" to 9/16" solid wood flooring (40230 Accessory shoe required)
- 1/2" to 9/16" engineered wood flooring (40230 Accessory shoe required)
- 5/8" bamboo* flooring (40248 Accessory shoe required)

SPECIFICATIONS

| | |
|--------------------|------------------|
| Operating Pressure | Manual |
| Fastener Capacity | 100 |
| Fastener Style | 16 Ga "T" Cleats |

- Blind nail 3/8" - 33/32" and face nail tongue and groove flooring using interchangeable shoe attachments
- Multi-hit minimizes fatigue while providing greater impact and floor tightness - no need to hit tool hard
- Ratcheting ram allows for single or multi-hit, guaranteeing nails are properly set every time
- Includes extension handle, mallet, angled shoe for 5/8" - 33/32" tongue and groove flooring, wrenches and rugged carrying case

| | |
|-------|--|
| 402A | 16 Ga Manual Floor Nailer (1/cs) |
| 40225 | Face Nail Shoe |
| 40230 | Thin Flooring Shoe (3/8" to 9/16" solid wood floors) |
| 40248 | Bamboo Flooring Shoe (5/8" horizontal or vertical grain) |

*Not recommended for stranded bamboo products

Portamatic Hammerhead TL

PORTA-NAILS



- 1/2" to 3/4" domestic solid wood flooring
- 1/2" solid & engineered wood flooring

SPECIFICATIONS

| | |
|--------------------|------------------------|
| Operating Pressure | 90 psi @ 4.2 cfm |
| Fastener Capacity | 150 |
| Fastener Style | 16 Ga "T" & "L" Cleats |

- Taller handle yields less back fatigue
- Mallet activated to ensure the tightest floor possible
- Integrated safety prevents accidental firing
- Includes mallet, wrenches, pneumatic lubricant, safety goggles, an easy to convert reversible shoe base for nailing 1/2" and 3/4" flooring, swivel air inlet connector and carrying case

| | |
|-------|---|
| 470A | 16 Ga Floor Nailer (1/cs) |
| 47395 | Pre finished Flooring Shoe, Wide Profile (9/16" to 3/4") (Order part #47090 for Original model #470) |

Not recommended for stranded bamboo products

Portamatic Evolution

PORTA-NAILS



- 3/8" to 3/4" engineered wood, solid wood, & bamboo flooring
- 3/8" to 5/8" stranded or woven bamboo products

SPECIFICATIONS

| | |
|--------------------|------------------|
| Operating Pressure | 80 psi @ 3.8 cfm |
| Fastener Capacity | 110 |
| Fastener Style | 18 Ga "L" Cleats |

- Unique ram design can be hit at any angle to get closer to the wall
- Cam operated height adjustment
- Quick access to the valve and main piston
- Safety mechanism is built into the base of the tool

| | |
|------|---------------------------|
| 418A | 18 Ga Floor Nailer (1/cs) |
|------|---------------------------|

3-in-1 Portamatic 465SLT

PORTA-NAILS



- 5/8", 3/4" & 33/32" domestic solid wood flooring
- 3/8" to 9/16" solid wood flooring
- 9/16" engineered wood flooring

SPECIFICATIONS

| | |
|--------------------|--|
| Operating Pressure | 70-115 psi |
| Fastener Capacity | 100-120 pieces |
| Fastener Style | 16 Ga "T" & "L" Cleats / 15.5 Ga Staples |

- 3-in-1 design allows for cleats or staples
- Mallet activated to ensure the tightest floor possible
- Integrated safety prevents accidental firing
- Includes mallet, wrenches, pneumatic lubricant, safety goggles, (2) shoe bases for nailing 1/2" and 3/4" flooring, and carrying case

465SLT 16 Ga 3-in-1 Floor Nailer/Stapler (1/cs)

Portamatic Evolution

PORTA-NAILS



- 3/8" to 5/8" engineered wood, solid wood, & bamboo* flooring

SPECIFICATIONS

| | |
|--------------------|--------------------|
| Operating Pressure | 100 psi @ 1.93 cfm |
| Fastener Capacity | 150 |
| Fastener Style | 18 Ga 1/4" Staples |

- Tool-free adjustable 'Elevator Shoe' for precise adjustment of varying flooring geometry
- Safety mechanism is built into the base of the tool
- Tool-free adjustable exhaust deflector
- Includes carrying case, safety goggles, air inlet, connector and hex wrenches

461A 18 Ga Floor Stapler (1/cs)

* Not recommended for stranded bamboo products

Portamatic Hammerhead S

PORTA-NAILS



- 1/2" & 3/4" domestic solid wood flooring
- 1/2" solid & engineered wood flooring

SPECIFICATIONS

| | |
|--------------------|------------------------|
| Operating Pressure | 90 psi @ 4.2 cfm |
| Fastener Capacity | 150 |
| Fastener Style | 15-1/2 Ga 1/2" Staples |

- Taller handle yields less back fatigue
- Mallet activated to ensure the tightest floor possible
- Integrated safety trigger prevents accidental firing
- Includes mallet, wrenches, pneumatic lubricant, safety goggles, an easy to convert reversible shoe base for nailing 1/2" and 3/4" flooring, swivel air inlet connector, and carrying case

472A 15-1/2 Ga Floor Stapler (1/cs)
47395 Prefinished Flooring Shoe, Wide Profile (9/16" to 3/4")
(Order part #47090 for original model #470)

Not recommended for stranded bamboo products

Fasteners - Cleats

"L" Head Flooring Porta-Nails Cleats

| Model # | DESCRIPTION | PER PACK | PER CASE | CASE WEIGHT | APPLICATION | TOOL MODEL |
|---------|--|----------|----------|-------------|---|------------|
| 4702 | 2" L-Porta-Nails, 16 Ga | 1000 | 5 | 19 lbs. | 1/2" to 3/4" Solid Wood | 470A |
| 4703 | 1-3/4" L-Porta-Nails, 16 Ga | 1000 | 5 | 18 lbs. | 1/2" to 3/4" Solid Wood | 470A |
| 4704 | 1-1/2" L-Porta-Nails, 16 Ga | 1000 | 5 | 16 lbs. | 1/2" to 3/32" Solid Wood | 470A |
| 47080 | 2" L-Porta-Nails, 16 Ga STAINLESS STEEL* | 1000 | 1 | 4 lbs. | 1/2" to 3/32" Solid Wood & ACQ Treated Wood | 470A |
| 41801 | 1-1/4" L-Porta-Nails, 18 Ga | 2000 | 5 | 19 lbs. | 3/8" to 9/16" Engineered Wood, Solid Wood & Stranded Bamboo | 418A |
| 41802 | 1-1/2" L-Porta-Nails, 18 Ga | 1200 | 5 | 16 lbs. | 3/8" to 3/4" Engineered Wood, Solid Wood & Stranded Bamboo | 418A |
| 41803 | 1-3/4" L-Porta-Nails, 18 Ga | 1200 | 5 | 17 lbs. | 3/8" to 3/4" Engineered Wood, Solid Wood & Stranded Bamboo | 418A |

"T" Head Flooring Porta-Nails Cleats

| Model # | DESCRIPTION | PER PACK | PER CASE | CASE WEIGHT | APPLICATION | TOOL MODEL |
|---------|--|----------|----------|-------------|---|------------|
| 42640 | 1-1/2" T-Porta-Nails, 16 Ga | 1000 | 5 | 15 lbs. | 1/2" to 3/4" Solid Wood | 402A, 470A |
| 42629 | 2" T-Porta-Nails, 16 Ga | 1000 | 10 | 42 lbs. | 1/2" to 3/32" Solid Wood | 402A, 470A |
| 42660 | 2" T-Porta-Nails, 16 Ga STAINLESS STEEL* | 1000 | 1 | 4 lbs. | 1/2" to 3/32" Solid Wood & ACQ Treated Wood | 402A, 470A |

*Stainless steel nails are recommended for use with "ACQ" decking.

Fasteners - Staples

1/2" Crown Flooring Staples

| Model # | DESCRIPTION | PER PACK | PER CASE | CASE WEIGHT | APPLICATION | TOOL MODEL |
|---------|---|----------|----------|-------------|--------------------------|------------|
| 47271 | 1-1/2" Crown Staples, 15-1/2 Ga, BCS Type | 1000 | 5 | 20 lbs. | 1/2" to 3/4" Solid Wood | 472A |
| 47261 | 2" Crown Staples, 15-1/2 Ga, BCS Type | 1000 | 5 | 24 lbs. | 1/2" to 3/32" Solid Wood | 472A |
| 4723 | 2" Crown Staples, 15-1/2 Ga, BCS Type | 7700 | 1 | 36.4 lbs. | 1/2" to 3/32" Solid Wood | 472A |

1/4" Crown Flooring Staples

| Model # | DESCRIPTION | PER PACK | PER CASE | CASE WEIGHT | APPLICATION | TOOL MODEL |
|---------|-----------------------------|----------|----------|-------------|--------------------------|------------|
| 46196 | 1" Crown Staples, 18 Ga | 5000 | 1 | 5.2 lbs. | 1/2" to 3/4" Solid Wood | 461A |
| 46197 | 1-1/4" Crown Staples, 18 Ga | 5000 | 1 | 6.6 lbs. | 1/2" to 3/32" Solid Wood | 461A |
| 46198 | 1-1/2" Crown Staples, 18 Ga | 5000 | 1 | 6.2 lbs. | 1/2" to 3/32" Solid Wood | 461A |

NWFA recommends that you follow the flooring manufacturers' installation guidelines regarding the tool and fastener to be used on your floors. The recommendations in this catalog are intended to be a guide to assist the user in placing the flooring fastener in the correct position, protect the pre finished surface and to obtain optimum installation results using industry standard guidelines. Always test the flooring for nail placement before full installation.

Universal Repair Kit

ROBERTS

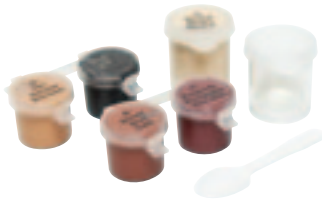

- Quickly repairs scratches, cracks and other damage
- For use with wood floors, vinyl floors & counters, wood cabinets, moldings and furniture
- 5 colors to custom mix and create unlimited shades to match any project

10-33 Universal Repair Kit (1/cs)

Wood, Laminate & Vinyl Putty

ROBERTS



- Fills gaps, nicks and scratches on flooring
- Acrylic based putty is easy to use and fast drying
- Can be sanded, painted or stained
- 8 color choices to match a wide variety of flooring
- 3 oz. tubes

| | | |
|--------|-------------------------|--------|
| PC7725 | Brown Repair Putty | (6/cs) |
| PC7726 | Light Repair Putty | (6/cs) |
| PC7727 | Light Red Repair Putty | (6/cs) |
| PC7728 | Gray Repair Putty | (6/cs) |
| PC7729 | Gold Tones Repair Putty | (6/cs) |
| PC7730 | Tan Repair Putty | (6/cs) |
| PC7731 | Dark Red Repair Putty | (6/cs) |
| PC7732 | Dark Brown Repair Putty | (6/cs) |

Pro Pull Bar

ROBERTS



- Used for floating floor and glue down installations of all brands of tongue and groove flooring
- 16-1/4" long; premium steel construction
- Angled profile allows planks to be tapped together in tight areas and at walls
- Soft felt backing protects floors from scratches during installation

10-18-8 Pro Pull Bar (8/cs)

Tapping Block

ROBERTS

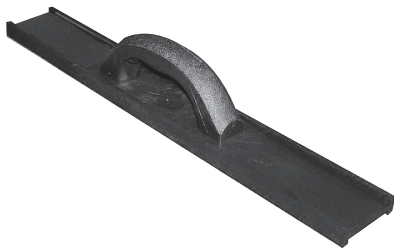

- Used to install all brands of tongue and groove flooring
- High density polypropylene base provides extended product life
- 20" profile equally distributes maximum tapping force
- Comfortable large grip handle
- 20" long

10-17-8 Tapping Block (8/cs)

Flooring Installation Kit

ROBERTS



- Used to install all brands of tongue and groove flooring
- Use with glue down and floating floor applications
- Kit contains: 30 Spacers, Tapping Block, Pull Bar

10-26 Flooring Installation Kit (10/cs)

10-27 Laminate Wedge Spacers Only (30 wedges/bag)

Flooring Mallet

PORTA-NAILS



- 60 oz. heavy duty mallet for use with mallet actuated nailers and staplers
- Balanced head to maximize striking force
- Flat face insures solid contact with the flooring tool
- Features a hickory handle and a non-marring rubber cap

40009 Flooring Mallet (1/cs)

Flooring Nail Set

PORTA-NAILS

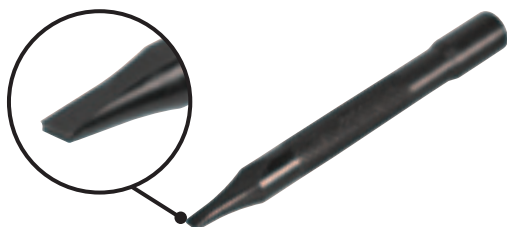

- Wide, anti-slip tip is designed to fit T and L flooring Nails/ Cleats or 18 Ga Flooring Staples
- Properly sets nails that are not counter set
- Black oxide finish inhibits rust
- Made of hardened tool steel

42620 Flooring Nail Set



VINYL TOOLS

Heavy Duty Linoleum Carpet Rollers

ROBERTS

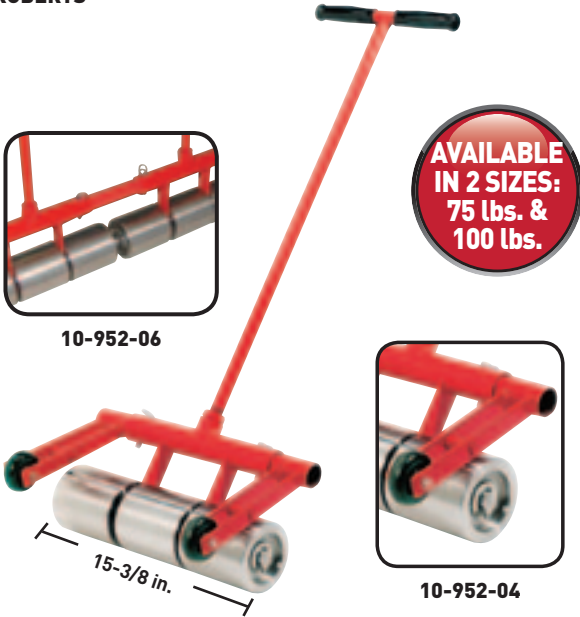

- Detachable transport wheel assembly kit for easy transport, upright support, and protection of segmented rollers included
- Chrome-plated segmented rollers exert even pressure on uneven surfaces
- Inset axles won't scuff walls
- 30" removable handle for convenient storage

| | |
|-----------|---|
| 10-950 | 75 lb. Roller (1/cs) |
| 10-952 | 100 lb. Roller (1/cs) |
| 10-952-04 | Replacement Transport Wheel Assembly Kit (1/cs) |
| 10-952-06 | Linoleum Roller Connector Tube (6/cs) |

Lightweight 35 lb. Roller

ROBERTS



- Lightweight, easy to carry on and off the job
- Ideal for "double glue" installations
- Chrome-plated segmented rollers exert even pressure on uneven surfaces
- Inset axles won't scuff walls
- 30" removable handle for convenient storage

| | |
|--------|----------------------|
| 10-935 | 35 lb. Roller (1/cs) |
|--------|----------------------|

Extendible Floor Roller

ROBERTS



- Great for rolling vinyl floor covering, carpet and cove base
- Handle extends from 17" to 27"
- Segmented rollers exert even pressure on uneven surfaces
- 7-3/8" wide non-marking rollers and inset axles won't scuff walls
- Second handle for additional leverage

| | |
|--------|--------------------------------|
| 10-955 | Extendible Floor Roller (1/cs) |
|--------|--------------------------------|

18" Vinyl Tile Cutter

ROBERTS

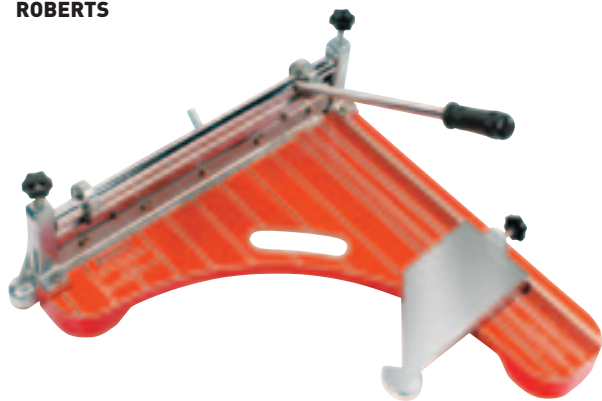

- Moveable cutting guide for consistent and accurate repetitive cutting of Vinyl Composition Tile (VCT)
- Built-in casters for greater maneuverability and rubber feet for added stability
- Clearly marked measuring guide and 45° miter guide
- Cuts 18" tiles or 12" tiles diagonally
- Extended two-year warranty

10-918 18" Vinyl Tile Cutter (1/cs)

12" Vinyl Tile Cutter

ROBERTS

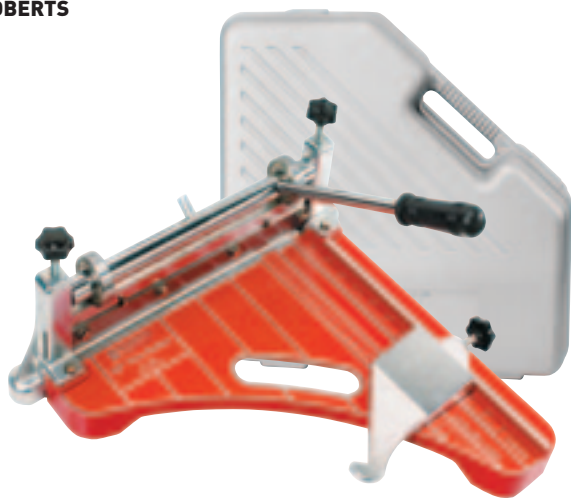

- Moveable cutting guide for consistent and accurate repetitive cutting of Vinyl Composition Tile (VCT)
- Built-in casters for greater maneuverability and rubber feet for added stability
- Clearly marked measuring guide and 45° miter guide
- Includes custom blow molded carrying case
- Cuts 12" tiles or 9 in. tiles diagonally
- Extended two-year warranty

10-900 12" Vinyl Tile Cutter (1/cs)

12" Vinyl Tile Cutter

ROBERTS



- Cuts vinyl tile up to 12" x 12"
- Hardened steel blades for accurate cuts
- Convenient carry handle for easy transport

10-895 12" Vinyl Tile Cutter (3/cs)

Quik-Cut Vinyl Tile Cutter

ROBERTS



- Cuts vinyl tile up to 12" x 12"
- Ball and needle bearings for long life and precise operation
- Hardened steel blades
- Die cast aluminum base

30002 12" Vinyl Tile Cutter (3/cs)

VCT Seam Roller

ROBERTS



- Use to roll seams on VCT and sheet vinyl
- Rounded outside edge
- 2" x 2" polished steel rollers mounted on 2 smooth rolling ball bearings
- Case hardened brackets resist axle wear

10-960 VCT Seam Roller (6/cs)

Wall Base Adhesive/Caulk Applicator

ROBERTS



- All steel construction
- Smooth rod push mechanism
- Holds 30 oz. cartridge

10-980 Wall Base Adhesive/Caulk Applicator (6/cs)

"Snozzle" Adhesive Applicator

ROBERTS

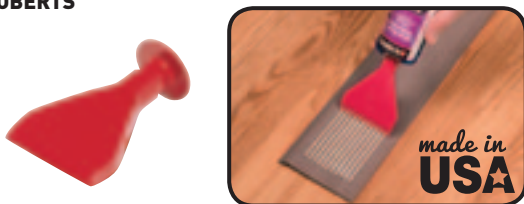

- Exclusive design spreads 11 rows of adhesive
- Creates a flat, well-bonded installation
- Fits all standard open end caulking guns
- Works with both 11 oz. and 30 oz. cartridges

10-981-25 "Snozzle" Adhesive Applicator (25/cs)

Flameless Heat Guns

ROBERTS



- Bends and softens floor tile, plastic laminates, linoleum, vinyl cove base and molding
- Superior air flow
- Safe, instant heat and circuit breaker protection
- Variable 200°F- 750°F temperature adjustment
- Lightweight, durable LEXAN® housing
- Sturdy LEXAN® stand included

10-189 200°- 750° Flameless Heat Gun (1/cs)

Topset Gouge

ROBERTS



- Grooves the back of vinyl or rubber cove base to allow the material to be tightly wrapped around corners
- 5/32" wide blade adjusts for depth and can be sharpened

10-279 Topset Gouge (12/cs)

Mozart Weld Rod Trimmer

MOZART



- Prevents nearly all damage to the floor covering, using one hand
- Unique cutting principle: the bottom of the blade hugs the floor allowing the highest points on the floor covering to determine where the wire is cut
- No sharpening needed - includes interchangeable, industrially manufactured, economical trimming blades
- Includes swivelling MOZART spacer claw, eliminating need for guide plate

10-1600 Mozart Weld Rod Trimmer (1/cs)
 10-8678 Mozart Trimmer Blades (5-pack blister card) (10/cs)
 10-8679 Mozart Weld Rod spacer claw 0.5mm (1 guide on blister card) (10/cs)
 10-8700 Mozart Weld Rod spacer claw 0.7mm (1 guide on blister card) (10/cs)
 10-041 Fixing Attachments (Spares, 1 screw with 3 spring washers) (10/cs)



UNDERLAYMENTS

AIRGUARD® Premium

ROBERTS



made in USA

- Sound resistant underlayment for use under all laminate and engineered hardwood floating floors
- Excellent moisture resistance, includes Microban protection
- Reduces ambient noise
- 8" overlap with adhesive strip for installation
- Outstanding compression resistance over time
- For use with below, on and above grade subfloors
- Ideal in condos and multi-level dwellings

70-105 100 sq. ft. roll - 40 in. x 30 ft. (12/cs)
70-105-1 630 sq. ft. roll - 40 in. x 189 ft. (1/cs)

| IIC Rating* | STC Rating* | R-Value* |
|-------------|-------------|----------|
| 68 | 67 | 0.39 |

First Step Premium 3-in-1

ROBERTS

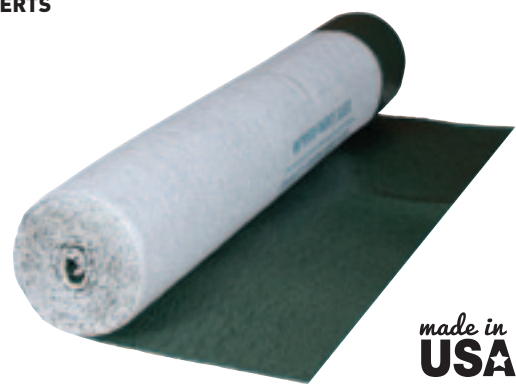

made in USA

- Sound resistant underlayment for use under all laminate and engineered hardwood floating floors
- Excellent moisture resistance
- Reduces ambient noise
- 4" overlap with adhesive strip for installation
- Outstanding compression resistance over time
- For use with below, on and above grade subfloors
- Ideal in condos and multi-level dwellings

70-102-12 100 sq. ft. roll - 40 in. x 30 ft. (12/cs)
70-102-1 630 sq. ft. roll - 40 in. x 189 ft. (1/cs)

| IIC Rating* | STC Rating* | R-Value* |
|-------------|-------------|----------|
| 68 | 67 | 0.39 |

Quiet Cushion®

ROBERTS

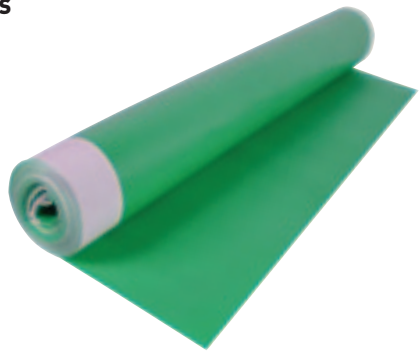

- 2mm Progressive Foam Technology (PFT) designed for supreme sound reduction
- Extra fine, cross linked foam for advanced moisture protection and shock absorption
- Delta Rating of 21 - one of the best in the industry
- Excellent for radiant heat floors, mold and mildew resistant
- Anti-crush technology for excellent performance and long life
- Includes adhesive strip and 3" overlap film
- For use under engineered and laminate flooring

70-180 100 sq. ft. roll - 43.5 in. x 27.5 ft. (12/cs)

| IIC Rating* | STC Rating* | Δ Rating* |
|-------------|-------------|-----------|
| 69 | 67 | 21 |

Soft Stride®

ROBERTS



- 2mm dense foam provides excellent sound reduction under engineered and laminate flooring
- Closed cell foam for excellent moisture protection
- Excellent for radiant heat floors, mold and mildew resistant
- Anti-crush technology for excellent performance and long life
- Includes adhesive strip and 3" overlap film

70-185 100 sq. ft. roll - 43.5 in. x 27.5 ft. (12/cs)

| IIC Rating* | STC Rating* | Δ Rating* |
|-------------|-------------|-----------|
| 69 | 66 | 21 |

* IIC measures sound such as moving furniture and walking, STC measures sound such as voices and television. Minimum sound rating required by most building codes and architects is 50. R-Value is the rating used to measure resistance to heat flow. Δ Delta Rating is the only true measurement of sound reduction from a product (not a floor assembly) in the industry.

Black Jack

ROBERTS

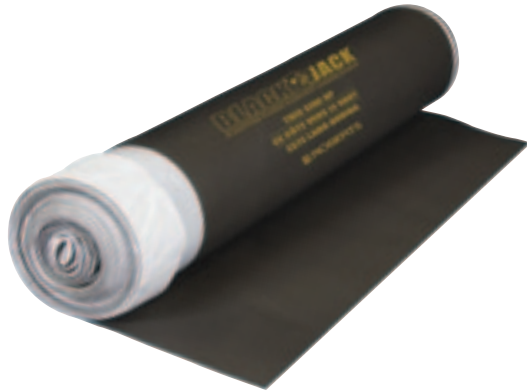

- 2.5mm thick foam provides optimal floor cushion
- Reduces surface noise as well as sound transference between floors
- Dense closed-cell structure provides high moisture resistance
- Mold and mildew resistant
- For use with below, on and above grade uses under laminate and engineered wood flooring
- Includes overlap and adhesive strip to seal out moisture and join multiple rolls

70-026 100 sq. ft. roll - 43 in. x 28 ft. (12/cs)
70-026-XL 600 sq. ft. roll - 43 in. x 167.5 ft. (2/cs)

| IIC Rating* | STC Rating* | Δ Rating* |
|-------------|-------------|-----------|
| 68 | 65 | 20 |

Super Felt®

ROBERTS

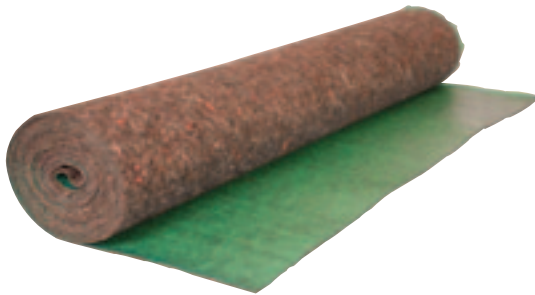

- Made from 80% recycled fibers, provides deep, rich sound by absorbing noise instead of deflecting it
- Extremely high temperature manufacturing process treats fibers
- Excellent for radiant heat floors, mold and mildew resistant
- 3mm thick pad corrects minor sub-floor imperfections
- 2 mil thick top film protects from harmful moisture vapor
- Added R-Value to chilly floors
- Includes adhesive strip and 3" overlap film
- For use under engineered and laminate flooring

70-190 100 sq. ft. roll - 44 in. x 27.3 ft. (1/cs)
70-193 360 sq. ft. roll - 44 in. x 98 ft. (1/cs)

| IIC Rating* | STC Rating* | Δ Rating* |
|-------------|-------------|-----------|
| 67 | 66 | 21 |

Unison® 2-in-1

ROBERTS



- 3/32" polyethylene foam increases cushioning between flooring and subfloor
- 4" film overlap with adhesive strip for seamless protection
- Top film protects from harmful moisture vapor

70-025 100 sq. ft. roll - 48 in. x 25 ft. (12/cs)

Serenity Foam

ROBERTS



- 3/32" polyethylene foam underlayment for laminate and engineered wood flooring
- Ideal for above grade uses
- Corrects minor subfloor imperfections

70-010 100 sq. ft. roll - 48 in. x 25 ft. (60/cs)

* **IIC** measures sound such as moving furniture and walking, **STC** measures sound such as voices and television. Minimum sound rating required by most building codes and architects is 50. **R-Value** is the rating used to measure resistance to heat flow. **Δ Delta Rating** is the only true measurement of sound reduction from a product (not a floor assembly) in the industry.

Cork Pro Plus

ROBERTS



- 2.5mm thickness reduces impact noise transmission through floors
- For glue down or floating installations of LVT, VCT, VET, sheet vinyl and linoleum floors
- Highly resistant to residual indentation
- Made from rapidly renewing and recycled cork with recycled EVA foam
- 85% recycled (post-industrial)

70-173 100 sq. ft. roll - 42 in. x 28.5 ft. (1/cs)

| Test Results | IIC Rating | STC Rating |
|------------------------------|------------|------------|
| 70-173 - with 6" cement slab | 55 | 55 |

Natural Cork Sheets

QEP / ROBERTS

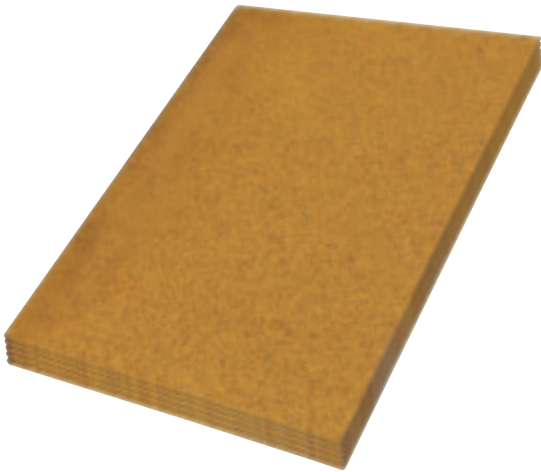

- Reduces sound transmission from both the surface of a floor as well as through the floor to living spaces below
- Use under ceramic tile, stone, marble, engineered hardwood and laminate floors
- Acts as a crack isolation membrane that resists transfer of stress cracks from subfloor through to flooring surfaces
- Reduces thermal transmission, increasing the effectiveness of floor heating systems

QEP

72025 1/8" (2.5mm) Natural Cork Sheets - 720 sq. ft./case, 2' x 3' (120/cs)
 72004 3/16" (4mm) Natural Cork Sheets - 456 sq. ft./case, 2' x 3' (76/cs)
 72005Q 1/4" (6mm) Natural Cork Sheets - 5 Pk - 30 sq. ft./pack, 2' x 3' (8/cs)
 72001Q 1/2" (12mm) Natural Cork Sheets - 150 sq. ft./case, 2' x 3' (25/cs)

ROBERTS

70-175 1/4" (6mm) Natural Cork Sheets - 300 sq. ft./case, 2' x 3' (50sh/pk)

| Test Results | IIC Rating | STC Rating |
|--|------------|------------|
| 72001Q - with 6" cement slab | 74 | 75 |
| 72001Q - with 6" cement slab and suspended ceiling | 88 | 89 |
| 72005Q - with 6" cement slab | 51 | 52 |
| 72005Q - with 6" cement slab and suspended ceiling | 61 | 60 |
| 72004 - with 6" cement slab | 49 | - |
| 70-175 - with 6" cement slab | 51 | 52 |
| 70-175 - with 6" cement slab and suspended ceiling | 61 | 60 |

Natural Cork Roll

QEP

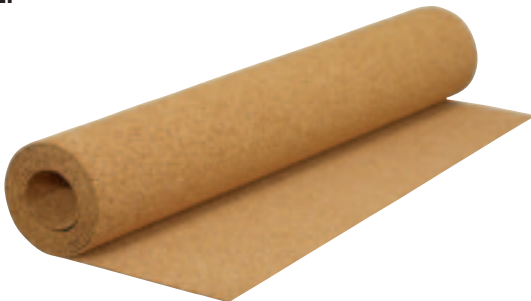

- Reduces sound transmission from both the surface of a floor as well as through the floor to living spaces below
- Use under ceramic tile, stone, marble, engineered hardwood and laminate floors
- Acts as a crack isolation membrane that resists transfer of stress cracks from subfloor through to flooring surfaces
- Reduces thermal transmission, increasing the effectiveness of floor heating systems

72000Q 1/4" (6 mm) Natural Cork Roll - 200 sq. ft. roll, 48" x 50' (1/cs)
 72003 1/4" (6 mm) Natural Cork Roll - 100 sq. ft. roll, 48" x 25' (1/cs)
 72008Q 1/8" (3 mm) Natural Cork Roll - 200 sq. ft. roll, 48" x 50' (1/cs)

| Test Results | IIC Rating | STC Rating |
|--|------------|------------|
| 72000Q - with 6" cement slab | 51 | 52 |
| 72000Q - with 6" cement slab & suspended ceiling | 61 | 60 |

* IIC measures sound such as moving furniture and walking, STC measures sound such as voices and television. Minimum sound rating required by most building codes and architects is 50.

SVS™ Silicone Vapor Shield™

ROBERTS



- Recommended for staple and nail down installations of solid and engineered wood floors
- Reduces vapor flow without trapping moisture
- Helps reduce dust and noise levels
- Meets perm ratings recommended by the National Wood Flooring Association
- Ok to use with radiant heat systems - No asphalt odor

70-198 200 sq. ft. roll, 33.5 in. x 72 ft. (6/cs)

Aquabar® "B" Moisture Vapor Barrier

ROBERTS



- Sub-floor barrier helps prevent buckling, cupping and cracking
- Ideal for interior installations of ceramic, porcelain or stone over cement board, plywood or concrete
- Finished or unfinished wood floors over plywood or concrete

70-195 500 sq. ft. roll - 36 in. x 167 ft. (1/cs)

Moisture Barricade

ROBERTS

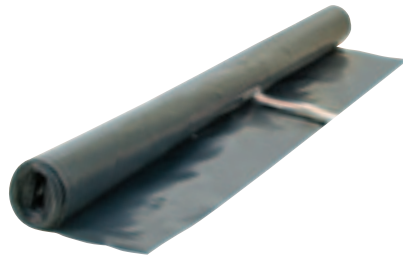

- Use with standard foam underlayments to protect against moisture
- 6 mil. thick polyethylene film for long life
- Roll unfolds to cover an extra large 10 ft. x 12 ft. area
- Use with laminate flooring with pre-attached underlayment

70-115 120 sq. ft. sheet - 10 ft. x 12 ft. (12/cs)

Waxed Paper Roll

ROBERTS



- 30-lb. heavy duty Kraft paper waxed on both sides for use with hardwood or engineered nail-down installations
- Use as a barrier between wood subfloor and new floor on above grade installations
- Helps in reducing squeaks in plywood subfloors
- Use to slide boards into place with ease

70-120 750 sq. ft. roll - 36 in. x 250 ft. (1/cs)



MASONRY

Magnetic Hammer

QEP

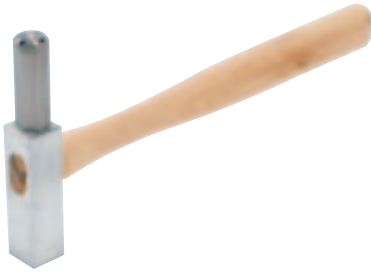

- Magnetic head holds nails for rapid installation of floor and ceiling channel to concrete
- Quality 13" wooden handle
- Size: 13" L x 5-3/4" W

61605 20 oz. Magnetic Hammer (12/cs)
61606 Magnetic Hammer-Head Only (1/cs)

Concrete Spreader with Brace

QEP

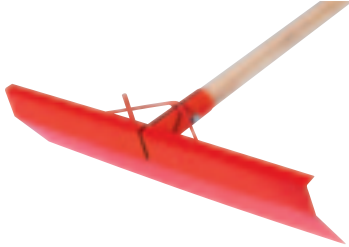

- 20" wide spreader grades
- Hook provided for pulling up reinforced wire
- 60" hardwood handle with reinforced welded blade

60201 Concrete Spreader with Brace (6/cs)

Simulated Brick Cutter

QEP



- Use to cut simulated brick face in mortar
- Adjustable height
- Hardwood handle with a 1/2" spring steel blade
- 5" L x 3/4" W x 3/4" H

60507 Simulated Brick Cutter (12/cs)

Segmented & Turbo Blades

Premium long-life contractor-grade segmented blade for fast cutting of brick, concrete block and pavers.

Premium multipurpose contractor-grade turbo blade for smooth cutting of brick, concrete block, pavers and stone.



| Item No. | Description | Application | Rim Height | Width | Arbor Size | Max RPM | No. in Case |
|-----------|----------------------------|--------------------------------------|------------|-------|--------------|---------|-------------|
| 6-7003SG | 7" Segmented - Wet/Dry | Brick, Concrete Block, Pavers | 7mm | .085 | 5/8"-7/8"-DM | 8730 | 10 |
| 6-7003TB | 7" BRUTUS® Turbo - Wet/Dry | Brick, Concrete Block, Pavers, Stone | 7mm | .085 | 5/8"-7/8"-DM | 8730 | 10 |
| 6-4005TBQ | 4" QEP Turbo - Wet/Dry | Brick, Concrete Block, Pavers, Stone | 7mm | .095 | 5/8"-7/8"-DM | 1500 | 10 |
| 6-7005TBQ | 7" QEP Turbo - Wet/Dry | Brick, Concrete Block, Pavers, Stone | 7mm | .095 | 5/8"-7/8"-DM | 8730 | 10 |

Calcium Chloride Moisture Test Kit

ROBERTS



- Measures moisture vapor emission rate and surface alkalinity of concrete subfloor
- Complies/exceeds ASTM F-1869 standard test method



Calcium Chloride Moisture Test Kit Includes:

- Anhydrous Calcium Chloride in plastic screw lid jar
- Transparent air tight plastic cover
- (2) pH alkalinity tests and solution
- Air tight mail pouch
- Self addressed envelope
- FREE third party test results and archival service

10-645 Calcium Chloride Moisture Test Kit (12/cs)
10-646 Calcium Chloride Moisture Test Kit 10 (3pk)



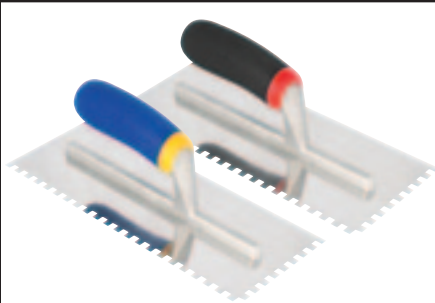





TROWELS

| Stainless Steel Comfort Grip Trowels | Standard Wood Handle Professional Trowels | Economy Trowels |
|---|--|--|
|  |  |  <i>made in USA</i> |
| <ul style="list-style-type: none"> • Rustproof stainless steel blade • Large, contoured and cushioned grip handles for comfort • High quality 11" x 4-1/2" trowel designed for the professional • Durable 230mm zinc die-cast shank • Extra handle-to-shank clearance to allow for complete hand rotation • Longer shank with 9 rivets. First and last rivet reinforced and welded No. in case 12 | <ul style="list-style-type: none"> • Hardened and tempered steel blade, grounded and polished for long lasting durability • Large wooden handle for an easy grip • Quality trowel measuring 11" x 4-1/2" designed for the professional installer • Aluminum die-cast shank • Some notches available in 16" lengths No. in case 12 | <ul style="list-style-type: none"> • Hard, cold-rolled steel blade for longer wear • High-impact black plastic handle • Quality trowel measuring 9" x 4" No. in case 30 Unless noted as - 12 |













Subfloor Prep

| Notch Size | Application | Brand | Comfort Grip (16" Blade) | Standard (11" Blade) |
|---------------------------|--|---------|--------------------------|----------------------|
| No Notch Finishing Trowel | For finishing the surface of the mortar or plaster beds to the required smoothness | QEP | | 49708Q |
| | | ROBERTS | 10-847 | |

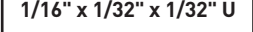
For Tile, Marble and Stone

| Notch Size | Application | Brand | Comfort Grip (11" Blade) | Standard (11" Blade) | Standard (16" Blade) | Economy |
|---|--|-----------|--------------------------|----------------------|----------------------|---------|
|  | For plastic, wall, ceramic & metal tile 6" x 6" or smaller and mosaics on drywall | QEP | 49917Q | 49715Q | | 10115Q |
| | | BRUTUS | 82144BR | 82125BR | | |
| | | TILEFORCE | | | | 82104TF |
|  | For ceramic, metal & aluminum wall tile 6" x 6" up to 12" x 12" | QEP | 49913Q | 49716Q | | 10116Q |
| | | BRUTUS | 82143BR | 82123BR | | |
| | | TILEFORCE | | | | 82102TF |
|  | For thinset application of ceramic tile 8" x 8" or smaller, laminated wood plank flooring, flat milled solid & shorts or plywood | QEP | 49915Q | 49713Q | 49725-1 | 10113Q |
| | | BRUTUS | 82142BR | 82122BR | | |
| | | TILEFORCE | | | | 82100TF |
|  | Thinset application of ceramic tile 8" x 8" up to 16" x 16" | QEP | 49916Q | 49714Q | | 10114Q |
| | | BRUTUS | 82140BR | 82120BR | | |
| | | TILEFORCE | | | | 82101TF |
|  | Thinset or medium bed mortar application of natural stone, quarry tile, pavers, saltillo and ceramic tiles 12" x 12" and larger | QEP | 49919Q | 49720Q | 49727-1 | |
| | | BRUTUS | 82141BR | 82124BR | | |
| | | TILEFORCE | | | | 82103TF |
|  | Thinset or medium bed mortar application of natural stone, quarry tile, pavers, saltillo and ceramic tiles 12" x 12" and larger | QEP | | 49795Q | | |
| | | BRUTUS | 82145BR | | | |

For Carpet, Vinyl Sheet, LVT, VCT and Wood

| Notch Size | Application | Brand | Comfort Grip (11" Blade) | Standard (11" Blade) | Economy |
|--|---|---------|--------------------------|----------------------|------------------|
| 1/8" x 1/8" x 1/16" Flat-Top V  | For secondary-backed carpet, direct glue-down and sheet vinyl installations | ROBERTS | | 49737 | 10137-12 |
| 1/16" x 1/16" x 1/16" SQ  | For carpet tile, fiberglass sheet, felt-backed sheet, luxury vinyl tile and plank | ROBERTS | | | 10125 10-180* |
| 1/16" x 1/16" x 1/16" SQ with 10° blade angle  | For carpet tile, fiberglass sheet, felt-backed sheet, luxury vinyl tile and plank | ROBERTS | 10-823 | 10-810 | 10-185* |
| 1/16" x 1/16" x 3/32" U  | For fiberglass sheet, felt-backed sheet, luxury vinyl tile and plank | ROBERTS | | 49736 | 10121-12 |
| 3/32" x 3/32" x 3/32" Flat-Top V with 10° blade angle  | For sheet vinyl and smooth backed carpets | ROBERTS | 10-833 | 10-820 | 10-185* |
| 1/16" x 1/32" x 1/32" U with 10° blade angle  | For VCT, vinyl, vinyl-backed wood plank | ROBERTS | 10-829 | 10-816 | 10111Q |
| 1/16" x 1/32" x 1/32" U  | For VCT, vinyl, vinyl-backed wood plank | ROBERTS | | | 10-180* |
| 1/16" x 1/32" x 5/64" U  | For carpet tile, fiberglass sheet, felt-backed sheet, luxury vinyl tile and plank | ROBERTS | | 49738 | 10122 |
| 1/4" x 1/4" x 1/4" Flat-Top V  | For pre-finished engineered wood plank, solid wood, bamboo and acrylic impregnated plank flooring | ROBERTS | 49739 | | 10142-12 |
| 3/8" x 5/16" V  | For bamboo, solid and engineered wood flooring from 1/2 to 3/4 in. thick | ROBERTS | | | 10143 |
| 1/4" x 3/16" Tiger Tooth®  | For bamboo, solid and engineered wood flooring up to 1/2 in. thick | ROBERTS | | 10-838 | 10144 |
| 3/16" x 1/4" x 1/2" Flat-Top V  | For laminated wood plank, solid wood, bamboo and acrylic impregnated plank flooring | ROBERTS | | 49730 | |
| 1/8" x 1/8" x 1/8" SQ  | For pre-finished parquet and wall base | ROBERTS | | 49732 | 10123-12 |

* Double Sided Trowels

Always check adhesive/mortar manufacturer's trowel recommendations before selecting a trowel notch. All Trowels Measure: Width x Depth x Space Apart

Recommended notch sizes by NTCA (National Tile Contractors Association)

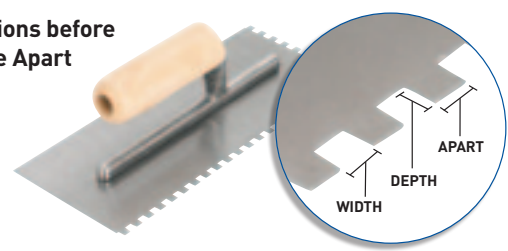

Wall Base Spreader

ROBERTS



- Durable cold-rolled steel blade for applying wall base adhesives
- Conveniently fits into a quart can

10033 Wall Base Spreader - V-Notch 3/16" x 5/32" (24/cs)

Margin Trowel

QEP / BRUTUS

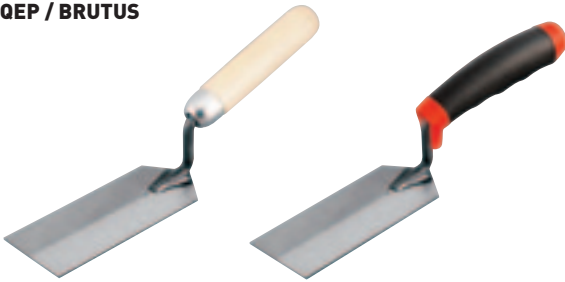

- For patch jobs, hard-to-reach areas and spreading thinset on v-cap or bullnose tile

QEP

42103Q 5" x 2" Margin Trowel No Notch (24/cs)
42105-12 5" x 2" V-Notch Margin Trowel 1/4" x 1/4" (24/cs)
42106-12 5" x 2"-SQ NotchMargin Trowel 1/4" x 1/4" (24/cs)

BRUTUS

82127BR 5" x 2" Margin Trowel No Notch (24/cs)
82128BR 5" x 2" V-Notch Margin Trowel 1/4" x 1/4" (12/cs)

Pointing Trowel

QEP / BRUTUS



- For patching cracks and shaping joints in brick, stone and concrete walls

QEP

92220Q 5-1/2" Pointing Trowel (12/cs)

BRUTUS

82126BR 5-1/2" Pointing Trowel (12/cs)

4-in-1 Spreader

TILEFORCE



- Notched edge for spreading adhesive
- Squeegee edge for grouting

10150TF 4-in-1 Spreader, Square Notch (10/case)
- 1/4" x 1/8" x 1/4" SQ
- 1/4" x 1/4" x 1/4" SQ
- 1/8" x 1/8" x 1/8" SQ
- 1/16" x 1/16" x 1/16" SQ

10151 4-in-1 Spreader, V Notch (10/case)
- 3/16" x 3/16" V
- 1/4" x 1/4" V
- 1/8" x 1/8" V
- Straight Edge



KNIVES & BLADES

Professional Carpet Knife

ROBERTS



- Special thumbstop design provides safety and increased cutting pressure
- Easy push button for quick blade changing
- Knurled grip assures firm grip

10-252 Professional Carpet Knife (Includes 3 Blades) (6/cs)
Uses replacement blades: 10-436, 10-438

Razor Blade Knife

ROBERTS



- Features safety guards to keep blade firmly in place
- Easy-open knob with bail to make blade changes more convenient
- Checkered handle for a slip resistant grip
- Rugged lightweight precision die cast aluminum
- Handle stores additional heavy duty slotted blades,

10-215 Razor Blade Knife (Includes 3 Blades) (6/cs)
Uses replacement blades: 10-436, 10-438

Cut & Jam Carpet Knife

ROBERTS



- Patented, unique dual function design; use one end to cut carpet and the other to jam carpet into gullies
- Features an easy-open knob with bail, safety thumb and blade guards
- Checkered handle for a slip resistant grip
- Rugged lightweight precision die cast aluminum
- Handle stores up to 10 additional heavy duty slotted blades, three blades included

10-220 Slotted Blade Carpet Knife (6/cs)
Uses replacement blades: 10-436, 10-438

Slotted Blade Carpet Knife

ROBERTS



- Contoured handle for precise cutting
- Finger blade guard
- Extra blade storage

10-253 Slotted Blade Carpet Knife (Includes 2 Slotted Blades) (6/cs)
Uses replacement blades: 10-436, 10-438

Big Fatso Multi-Purpose Knife

ROBERTS



- Offset head gives knuckle room and convenient, precise cutting angle
- Large contoured handle for comfort
- Unscrew end cap and swing open for quick and easy blade change
- Uses most standard utility and hook blades with 2 or 3 positioning slots on top
- Handle stores additional standard or heavy duty utility and hook blades

10-218 Big Fatso Multi-Purpose Knife (Includes 3 Blades) (12/cs)
Uses replacement blades: 10-434, 10-440

Professional Fixed Blade Utility Knife

ROBERTS



- Easy-open knob with bail to make blade changes more convenient
- Checkered handle for a slip resistant grip
- Uses standard replacement blades with 1, 2 or 3 positioning slots on top
- Handle stores additional standard or heavy duty utility blades

10-920-6 Professional Fixed Blade Utility Knife (Inc. 3 Blades) (6/cs)
Uses replacement blades: 10-434, 10-388, 10-444

Linoleum Knife

ROBERTS



- Cuts linoleum, vinyl sheet goods
- Heavy gauge, high carbon steel blade
- Makes accurate, even cuts without burrs
- Soft, comfort grip handle with hang hole
- Double edge sharp blade will provide years of perfect cuts

10-931 Linoleum Knife (12/cs)

Slide-Lock Scoring Knife

QEP



- Twin carbide scoring knife
- Double slide-lock-knife
- Chisel tip

10098Q Slide-Lock Scoring Knife (6/cs)

Pro Flooring Cutter Blades

ROBERTS



High quality 4 mm Tungsten Carbide replacement blades:

| | |
|--------|--|
| 10-460 | 9" Replacement Blade for 10-60 (1/cs) |
| 10-464 | 13" Replacement Blade for 10-64 (1/cs) |
| 10-466 | 18" Replacement Blade for 10-66 (1/cs) |
| 10-468 | 25" Replacement Blade for 10-68 (1/cs) |

4" Floor/Wall Scraper Blades

ROBERTS



Fits Roberts 10-194, 10-294 Floor Scraper and most other brands

Blade Specifications: 4 in. long x .015 in. thick
 10-442 10 Blade Blister Card 10 cards/case (100 blades)

8" Floor/Wall Scraper Blades

ROBERTS



Fits Roberts 10-296 Stand-Up Scraper, and most other brands

Blade Specifications: 8" long x 0.74" wide x .035" thick
 10-458 10 Blade Tube 1 tube (10 blades)

Heavy Duty Slotted Blades (Blue)

ROBERTS



Fits Roberts 10-146-3, 10-146GT Cushion Back Cutter, 10-147 Cushion Back Cutter with Row Finder, 10-152-3, 10-152 GT Loop Pile Cutter, 10-154 Loop Pile Cutter, 10-252 Professional Carpet Knife, 10-215 Razor Blade Knife, 10-253 Slotted Blade Carpet Knife, 10-220 Cut & Jam Carpet Knife, 10-905 Multipurpose Wall Trimmer, and most other brands

Blade Specifications: 2.25" long x .017" thick
 10-436 10 Blade Blister Card 10 cards/case (100 blades)
 10-438 100 Blade Pack - Bulk 10 packs/case (1000 blades)

Heavy Duty Utility Blades

ROBERTS

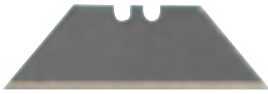

Fits Roberts 10-208-3, 10-218 and 10-920-6 Utility Knives, and most other brands

Heavy Duty Blade Specifications: 2.28" long x .025" thick
10-434 100 Blade Pack - Bulk 10 packs/case (1000 blades)

Hooked Blades

ROBERTS

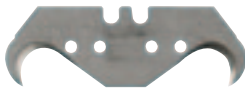

Fits Roberts 10-905 Multipurpose Wall Trimmer

Blade Specifications: 1.84" long x .025" thick
10-440 10 Blade Blister Card 10 cards/case (100 blades)

Trimmer Blades

ROBERTS



Fits Roberts 10-154-3 Loop Pile Cutter, 10-616-2 Conventional Carpet Trimmer, 10-920-6 Professional Utility Knife, and most other brands

Blade Specifications: 2.125" long x .017" thick
10-388 100 Blade Pack - Bulk 10 packs/case (1000 blades)



Blade Specifications: 2.18" long x .017" thick
10-444 10 Blade Blister Card 10 cards/case (100 blades)

Strip Cutter Blades

ROBERTS



Fits Roberts 10-108 Strip Cutter

Blade Specifications: 1.86" long x .45" wide x .038" thick
10-439 6 Blade Blister Card 10 cards/case (60 blades)

10 Gauge Concrete Nails

ROBERTS



- A heavy 10-gauge shank nail for use on extremely hard or "aged" concrete

33-100 5/8" Concrete Nails 1 lb. Bag 10/cs

Chisel Point Staples

ROBERTS



- Get jam-proof efficiency with its "V" shaped points that drive easily into most wood floors

30-110 3/8" Staples 5000/bx 20/cs

Divergent Point Staples

ROBERTS



- Easily penetrate vinyl tile, linoleum, felt and wood (including hardwoods) with its 60° point
- Get added holding power when staple legs veer in opposite directions

30-210 3/8" Staples 5000/bx 20/cs

Cement Board Screws

QEP / TILEFORCE



- For use in the attachment of Durock[®], Wonderboard[®] and HardieBacker[®] cement board
- No pre-drilling necessary
- Corrosion resistant coating
- Wafer head with ribbed countersinking profile for flush seating

QEP
99602 1-1/4" - # 8 High Low Cement Board Screws,
200 screws/pkg (12/case)

TILEFORCE
82605TF 1-1/4" - # 8 High Low Cement Board Screws,
200 screws/pkg (12/case)
82606TF 1-1/4" - # 8 High Low Cement Board Screws,
800 screws/pkg (8/case)
82607TF 1-5/8" - # 8 High Low Cement Board Screws,
150 screws/pkg (12/case)
82608TF 1-5/8" - # 8 High Low Cement Board Screws,
600 screws/pkg (8/case)



TAPE

Max Grip® Vinyl Floor Installation Tape

ROBERTS



- For the permanent installation of vinyl flooring, wall base, stairs & treads and vinyl trim
- Perfect for modified loose lay vinyl sheet flooring installation
- Aggressive, acrylic adhesive with reinforced scrim webbing for extra strength
- Great for flooring repairs

50-540 Vinyl Installation Tape - 1-7/8" x 50' (12/cs)

Max Grip® Carpet Installation Tape

ROBERTS



- For the permanent installation of carpet, moldings and trim
- Aggressive, acrylic adhesive with reinforced scrim webbing for extra strength
- Works on indoor and outdoor installations
- Ideal for stairs and treads

50-550 Carpet Installation Tape - 1-7/8" x 75' (12/cs)

Rug Traction™ Anti-Slip Rubber Tape

ROBERTS

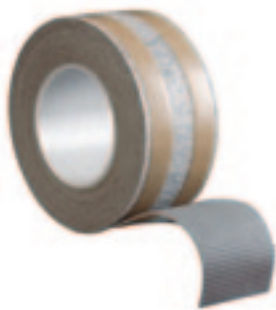

- Specially designed non-slip strip for holding rugs and mats in place
- One side attaches permanently to the rug and the other side provides a non-slip surface for additional traction
- Easy to apply and requires no clean up

50-545 Rug Traction Anti-Slip - 2-1/2" x 25'
Individually Boxed (12/cs)

Duct Tape

ROBERTS

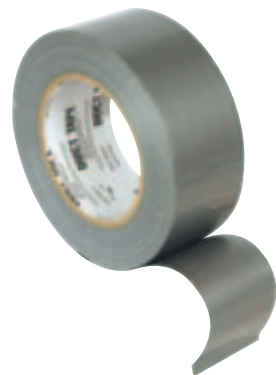

- Great for general repairs, projects, packing, seaming and sealing
- Easily tears by hand
- Conforms easily to uneven surfaces

50-555 Duct Tape - 1-7/8" x 60 yds, Individually Packaged (36/cs)

Rug Gripper™

ROBERTS

made in
USA



- Holds rugs & mats in place on all floor surfaces
- Safe for all floor surfaces, including carpet
- Removable, repositionable

| | |
|--------|--|
| 50-580 | Rug Gripper for Small Rugs – 2-1/2" x 25' roll (6/cs) |
| 50-584 | Rug Gripper For Accent Rugs – 10" x 20" flat sheet (12/cs) |
| 50-582 | Rug Gripper for Small Rugs Value Roll – 2-1/2" x 60' roll (6/cs) |

Carpet Gripper™

ROBERTS

made in
USA



- Pressure sensitive adhesive mesh tape for removable installations
- Easy installation alternative to adhesive or tackstrip
- Use over any floor surface, including carpet
- Removable, repositionable

| | |
|--------|---|
| 50-588 | Carpet Gripper for Carpet Installation – 3" x 60' roll (6/cs) |
|--------|---|

Cement Board Seam Tape

QEP / TILEFORCE

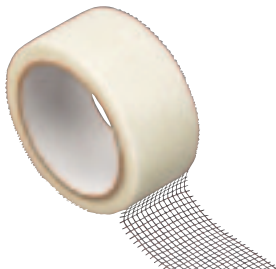

- For use in seaming all types of cement backerboard and tile underlayment
- Alkali resistant fiberglass mesh, self-adhesive tape – reduces taping time
- Resists tears and will not shrink

| | |
|--------|---|
| QEP | |
| 99600Q | Cement Board Seam Tape – 2" x 50' roll (24/cs) |
| 99603Q | Cement Board Seam Tape – 2" x 300' roll (24/cs) |

| | |
|-----------|---|
| TILEFORCE | |
| 82433TF | Cement Board Seam Tape – 2" x 50' roll (24/cs) |
| 82434TF | Cement Board Seam Tape – 2" x 300' roll (24/cs) |



TEAR-OUT

14" Surface Scraper

QEP / TILEFORCE

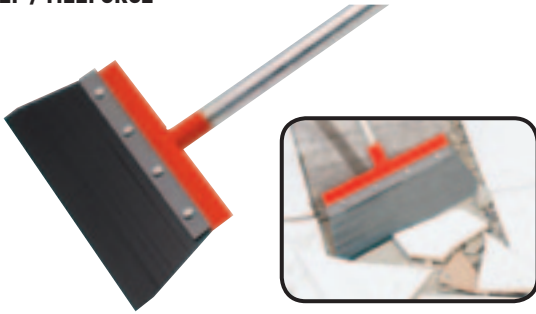

made in
USA

- Flexible 14" blade helps remove old floors and clean up excess debris
- 5' long handle and flex blade made of premium quality carbon steel offer long-lasting durability

| | |
|--------|---------------------------------------|
| QEP | |
| 20900Q | 14" Surface Scraper with Blade (6/cs) |
| 21000Q | 14" Replacement Blade (3/cs) |
| 60206 | 18" Surface Scraper with Blade (6/cs) |
| 60208 | 18" Replacement Blade (6/cs) |

| | |
|-----------|---------------------------------------|
| TILEFORCE | |
| 82900TF | 14" Surface Scraper with Blade (6/cs) |
| 82901TF | 14" Replacement Blade (3/cs) |

12" Power Scraper

QEP / BRUTUS

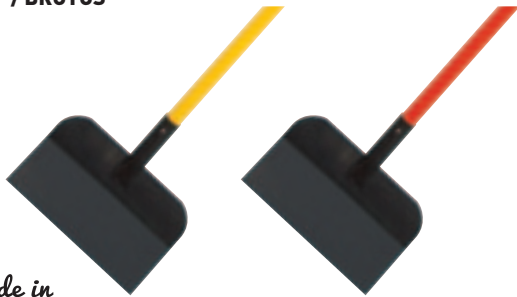

made in
USA

- Lifetime warranty reinforced fiberglass handle
- Removes tile, wood, laminate, adhesive, stone and carpet
- Resharpens quickly with file or grinder - No replacement blade necessary

| | |
|--------|--------------------------|
| QEP | |
| 62995Q | 12" Power Scraper (3/cs) |

| | |
|---------|--------------------------|
| BRUTUS | |
| 82995BR | 12" Power Scraper (3/cs) |

Reversible Power Scraper

BRUTUS



made in
USA

- Great for removing tile, wood, laminate, stone, carpet, ice and roofing
- Unique reversible hardened steel blade can easily be converted from 5" to 3" wide (ideal for scraping in tight areas)
- Resharpenable hard steel (use file or grinder)
- Galvanized steel ergonomic handle reduces fatigue

| | |
|---------|---------------------------------|
| BRUTUS | |
| 82910BR | Reversible Power Scraper (3/cs) |

Reversible Demolition Scraper

QEP

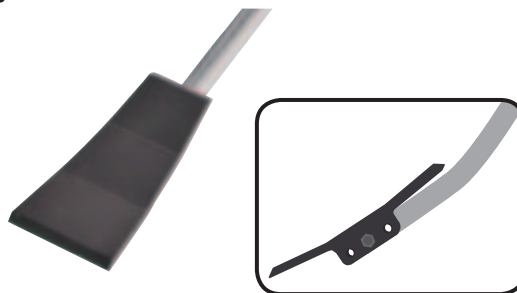

made in
USA

- Double angled design offers increased leverage during scraping and prying
- Great for removing tile, wood, laminate, stone, carpet, ice and roofing
- Unique reversible hardened steel blade can easily be converted from 5" to 3" wide (ideal for scraping in tight areas)
- Resharpenable hard steel (use file or grinder)
- Galvanized steel ergonomic handle reduces fatigue

| | |
|--------|--------------------------------------|
| 62965Q | Reversible Demolition Scraper (3/cs) |
|--------|--------------------------------------|

7" Heavy-Duty Floor Scraper

QEP / BRUTUS

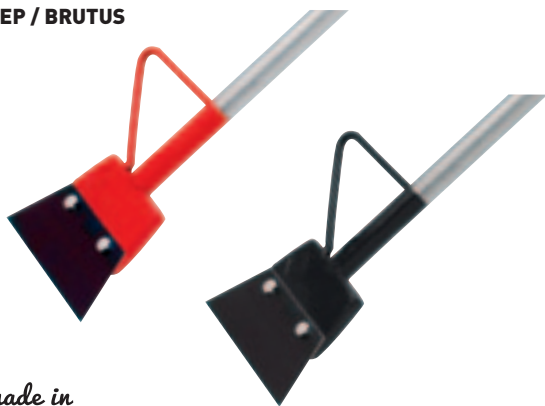

made in
USA

- Thick, professional high-carbon steel 7" blade scrapes up concrete, marble, ceramic tile and wood floors
- All welded construction made of pipe steel with a replaceable rigid blade
- Rips up roofing, asphalt, tile and chips away cement and plaster
- 4' long handle includes foot peg for better leverage on difficult projects
- Great for ice removal

QEP

75006Q 7" Heavy-Duty Floor Scraper with Blade (6/cs)

75007Q 7" Replacement Blade (3/cs)

BRUTUS

89006BR 7" Heavy-Duty Floor Scraper with Blade (6/cs)

89007BR 7" Replacement Blade (3/cs)

8" Adjustable Razor Floor Scraper

QEP / TILEFORCE



- Twist lock adjustable telescoping handle adjusts from 3' to 6' in length
- Removes old tile, adhesive, vinyl, carpet and other floor covering materials
- Deluxe cushioned grip handle provides added comfort
- 15° angled 8" blade head for ease of comfort when scraping
- Canvas blade guard included

QEP

62909Q 8" Adjustable Razor Floor Stripper (6/cs)

62904Q 8" Replacement Blade (3 on a skincard) (10/cs)

62907Q 8" Replacement Blades (10 on a skincard) (1/cs)

TILEFORCE

82905TF 8" Adjustable Razor Floor Stripper (6/cs)

82903TF 8" Replacement Blade (3 on a skincard) (10/cs)

Stand-Up Scraper

ROBERTS



- Professional stand-up scraper
- Steel shank molded into head, welded to steel handle
- Deluxe cushioned grip handle, adjustable from 3' to 6'
- Sturdy construction with an 8" hardened steel blade and locking cam
- Features a 15° angled head

10-296 Stand-Up Scraper (6/cs)

10-458 8" Floor/Wall Scraper Replacement Blades (10 blades) (10/cs)

Heavy Duty 6" Convertible Scraper

ROBERTS

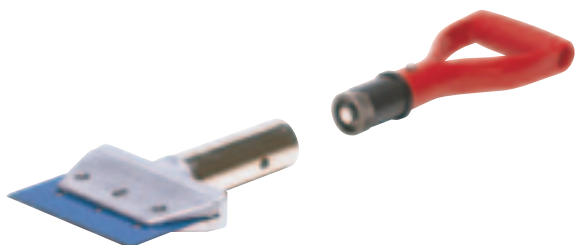

- Dependable heavy duty scraper easily converts to a stand-up scraper with the addition of a stretcher extension tube (sold separately)
- "Action lock" handle adjusts 360° to any position
- Comfortable molded handle maximizes thrust and conserves energy
- Includes a 6" hardened steel blade, heavy duty cast aluminum scraper head and a hardened steel locking cam
- Add 3' stretcher extension tubes to achieve desired length

10-195 Heavy Duty 6" Convertible Scraper (1/cs)

10-195-01 6" Hardened Steel Replacement Blade (1/cs)

10-230-10 3' Steel Stretcher Tube (1/cs)

Floor/Wall Scrapers

ROBERTS



- Angled head provides “clean shaving” cutting action, perfect for stripping floors, walls and wallpaper
- Features three blade clamp screws for maximum blade holding power and flex-grip anti-fatigue vinyl hand grip

| | |
|--------|---|
| 10-194 | 4" Floor/Wall Scraper - 12" handle |
| 10-294 | 4" Floor/Wall Scraper - 18" handle |
| 10-442 | 4" Floor/Wall Scraper Replacement Blade (10 pcs.) (10/cs) |

4" Razor Scraper

QEP / TILEFORCE



- Scrapes residue off subfloors, windows and walls
- Great for wallpaper removal
- Complete with 4" blade

| | |
|--------|---|
| QEP | |
| 62900Q | 4" Razor Scraper (12/cs) |
| 62901Q | 4" Razor Scraper Replacement Blades (5 on a skincard) (6/cs) |
| 62801Q | 4" Razor Scraper Replacement Blades (10 on a skincard) (1/cs) |

| | |
|-----------|--|
| TILEFORCE | |
| 82904TF | 4" Razor Scraper (12/cs) |
| 82902TF | 4" Razor Scraper Replacement Blades (5 on a skincard) (6/cs) |

Chisel Scraper

QEP / BRUTUS

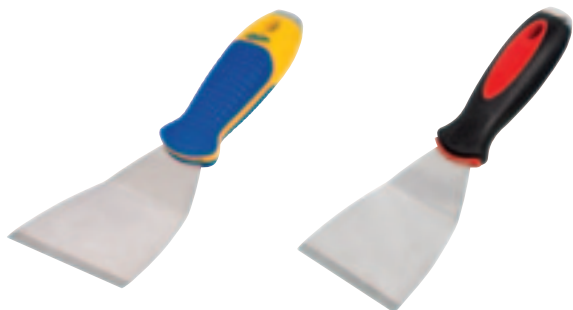

- 3" stainless steel blade
- Multi-functioning tool ideal to remove debris, adhesive and residue from most surfaces
- Hammer end for quick strike use on stubborn material

| | |
|--------|-----------------------|
| QEP | |
| 62970Q | Chisel Scraper (6/cs) |

| | |
|---------|-----------------------|
| BRUTUS | |
| 89970BR | Chisel Scraper (6/cs) |

Multi-Scrapers

QEP



- Fits most reciprocating saws
- Heavy duty resharpenable blade blasts through thinset, linoleum, drywall mud, paint and glue
- Twisted shank keeps interchangeable blades at a comfortable angle

| | |
|--------|---------------------------------------|
| 62985Q | 2" Multi-Scraper (6/cs) |
| 62986Q | 2", 4" & 6" Multi-Scrapers Kit (6/cs) |

20 oz. Ripping Hammer

ROBERTS



- Sturdy, quality hickory construction
- Long straight claw is ideal for pulling up old tackstrip
- 20 oz. head
- Contoured handle provides optimal strength while minimizing impact shock
- 14" long

10-114 20 oz. Ripping Hammer (6/cs)

Carpet Puller

ROBERTS



- Unique design provides maximum pulling power
- Serrated clamps provide firm carpet grip, great for removing carpet
- Large comfortable handle
- Die-cast aluminum

10-10 Carpet Puller (2/cs)

Base Molding Lifter

ROBERTS



- Perfect angles provide ideal leverage for removing base molding and tackstrip
- New deep bevel nail slot for easy nail removal
- Constructed from high carbon forged steel with bright nickel plating
- 10-1/2" long

10-510-3 Base Molding Lifter (3/cs)



CEILING

12 Gauge Hanger Wire - 100'

SUSPEND-IT



- Suspends main tees from eye lag screws in commercial applications

8850 12 Gauge Hanger Wire (12/case)

18 Gauge Hanger Wire - 300'

SUSPEND-IT



- Suspends main tees from eye lag screws in commercial applications

8851 18 Gauge Hanger Wire (12/cs)

Light Duty Hanger Wire Installation Kit

SUSPEND-IT

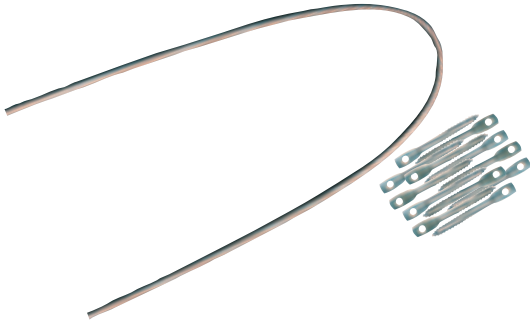

- Suspends main tees in residential applications of approximately 192 sq. ft. with a maximum drop of 18"

Contains:

- 12 pieces of 30" long, 18 gauge hanger wire
- 12 eye lag screws for wood joists

8854 Light Duty Hanger Wire Installation Kit (12/cs)

Wire-Fastening Nail Hooks

SUSPEND-IT



- Attaches ceiling hanger wire to wood

8855 Wire-Fastening Nail Hooks - 20 pack (12/cs)

Eye Lag Screws for Wood Joist

SUSPEND-IT

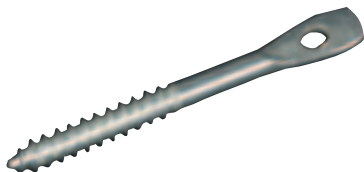

- Attaches ceiling hanger wire to wood joists
- 1/4" x 3" self-tapping sharp point

8856 12 Eye Lag Screws for Wood Joists - 100 pack (12/cs)

Eye Lag Screws for Metal Joist

SUSPEND-IT

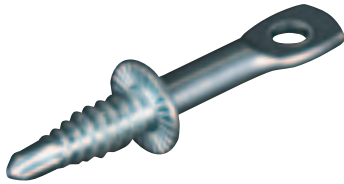

- Attaches ceiling hanger wire to metal joists
- 1/4" x 2" self-tapping drill point

8857 Eye Lag Screws for Metal Joist - 50 pack (12/cs)

Eye Lag Screw Drill Adapter

SUSPEND-IT



- Attaches to any 3/8" power drill
- For easy installation of eye lag screws

8858 Eye Lag Screw Drill Adapter (24/cs)

Rivets

SUSPEND-IT



- Rivets acoustical ceiling tile tees to perimeter wall angles at 4' intervals

8859 Rivets - 100 pack (24/cs)

Leveling Line - 450'

SUSPEND-IT

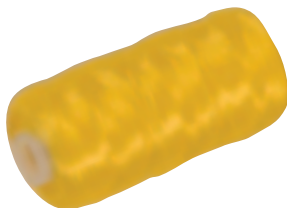

- Optic yellow color provides excellent visibility in any leveling job site
- Used in leveling and squaring suspended ceiling grid

8860 Leveling Line (12/cs)

Grid Clamps

SUSPEND-IT

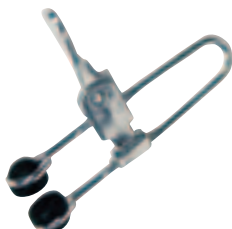

- Holds leveling lines during installation of main and cross tees
- Temporarily secures main and/or cross tees to wall angles when riveting

8861 Grid Clamps - 6 pack (12/cs)

Mounting Clips

SUSPEND-IT



- For mounting electrical boxes, fire detectors, or other devices from main tees

8862 Mounting Clips - 4 pack (12/cs)

Panel Clips

SUSPEND-IT



- Holds ceiling tile panels secure against the grid in drafty areas

8863 Panel Clips - 20 pack (12/cs)

Light-Duty Ceiling Hooks

SUSPEND-IT



- Hangs lightweight objects such as plants, signs and decorations from ceiling tees

8864 Light-Duty Ceiling Hooks - 4 pack (24/cs)

Grid Installation Kit

SUSPEND-IT



Value pack contains tools and hardware to install ceiling grid in a 20' x 20' room (400 sq. ft.)

Kit contains:

- 18 gauge hanger wire - 64'
- 2 grid clamps
- 1 eye lag screw drill adapter
- 50' leveling line
- 20 white rivets
- 16 eye lag screws for wood joists

8865 Grid Installation Kit (12/cs)

INDEX

By Item Number

| Item # | Description | Page # | Item # | Description | Page # |
|-----------|--|--------|------------|---|--------|
| 6-1001Q | 10" Continuous Rim - Wet/Dry | 11 | 10-146-3 | Cushion Back Cutter | 43 |
| 6-1003Q | 10" Continuous Rim - Wet | 11 | 10-146GT | GT Cushion Back Cutter | 43, 49 |
| 6-1008BW | 10" BLACK WIDOW® Blade | 11 | 10-147 | Cushion Back Cutter with Row Finder | 44 |
| 6-4001Q | 4" Continuous Rim - Wet/Dry | 11 | 10-151 | Nail Driving Bar | 46, 49 |
| 6-4003Q | 4" Continuous Rim - Wet/Dry | 11 | 10-152-3 | Loop Pile Cutter | 43 |
| 6-4005TBQ | 4" QEP Turbo - Wet/Dry | 12, 70 | 10-152GT | GT Loop Pile Cutter | 43, 49 |
| 6-4008BW | 4" BLACK WIDOW® Blade | 11 | 10-154-3 | Universal Seam Cutter | 44, 49 |
| 6-7001Q | 7" Continuous Rim - Wet/Dry | 11 | 10-161 | 24" Steel Tool Box | 48, 49 |
| 6-7003Q | 7" Continuous Rim - Wet | 11 | 10-162 | 16" Seaming Iron Case | 48 |
| 6-7003SG | 7" Segmented - Wet/Dry | 12, 70 | 10-169 | 4" Loop Pile Seam Roller | 42, 49 |
| 6-7003TB | 7" BRUTUS® Turbo - Wet/Dry | 12, 70 | 10-170 | 4" Cut Pile Seam Roller | 42 |
| 6-7005TBQ | 7" QEP Turbo - Wet/Dry | 12, 70 | 10-180 | Double Sided Trowel | 73 |
| 6-7006GLQ | 7" Glass Tile Cutting Diamond Blade | 12 | 10-185 | Double Sided Trowel | 73 |
| 6-7008BW | 7" BLACK WIDOW® Blade | 11 | 10-189 | 200°- 750° Flameless Heat Gun | 63 |
| 6-8001Q | 8" Continuous Rim - Wet/Dry | 11 | 10-194 | 4" Floor/Wall Scraper - 12" handle | 87 |
| 6-8003Q | 8" Continuous Rim - Wet | 11 | 10-195 | Heavy Duty 6" Convertible Scraper | 86 |
| 6-8008BW | 8" BLACK WIDOW® Blade | 11 | 10-195-01 | 6" Hardened Steel Replacement Blade | 86 |
| 10-041 | Fixing Attachment | 63 | 10-215 | Razor Blade Knife | 76 |
| 10-10 | Carpet Puller | 90 | 10-218 | Big Fatso Multi-Purpose Knife | 77 |
| 10-17-8 | Tapping Block | 59 | 10-220 | Slotted Blade Carpet Knife | 76 |
| 10-18-8 | Pro Pull Bar | 59 | 10-227 | Karpet Kart | 52 |
| 10-26 | Flooring Installation Kit | 59 | 10-227-02A | Karpet Kart Replacement Wheels | 52 |
| 10-27 | Laminate Wedge Spacers | 59 | 10-230-10 | 3' Steel Stretcher Tube | 36, 86 |
| 10-33 | Universal Repair Kit | 58 | 10-230-3K | Tube Case with Three 3' Extension Tubes | 37 |
| 10-35 | 8" Laminate Cutter | 55 | 10-230-40 | Empty Stretcher Case with Wheels | 37 |
| 10-46 | Super Six 6" Jamb Saw | 45 | 10-230-41 | Empty Tube Case | 37 |
| 10-47-2 | 6-3/16" 36-Tooth Carbide Tip Saw Blade | 45 | 10-232 | 3' Stretcher Tube Carrying Case | 36 |
| 10-47-6 | 6-3/16" 20-Tooth Carbide Tip Saw Blade | 45 | 10-235-05 | 5' Aluminum Stretcher Tube | 36 |
| 10-50 | E•Z Slides 6-3/4" wide x 48" long | 52 | 10-235-10 | 3' Aluminum Stretcher Tube | 36 |
| 10-51 | E•Z Slides 6-3/4" wide x 11-1/2" long | 52 | 10-237 | Junior Power Stretcher | 37 |
| 10-55-24 | Masonry Blade | 45 | 10-237-50 | Replacement Power Head | 37 |
| 10-56 | Longneck Plus 6" Jamb Saw | 45 | 10-237V | Junior Power Stretcher Value Kit | 37 |
| 10-60 | 9" Flooring Cutter | 55 | 10-245 | SharkTeeth Knee Kicker Grips | 40 |
| 10-64 | 13" Pro Flooring Cutter | 55 | 10-248 | Nap Grip Head | 38 |
| 10-66 | 18" Pro Laminate Cutter | 54 | 10-250 | Adjustable Locking Tube | 36 |
| 10-68 | 25" Pro Laminate Cutter | 54 | 10-252 | Professional Carpet Knife | 49, 76 |
| 10-100 | 5" Extra Wide Carpet Seam Roller | 42 | 10-253 | Slotted Blade Carpet Knife | 76 |
| 10-101 | 4½" Deluxe Carpet Seam Roller | 42 | 10-254 | Power-Lok Stretcher | 36 |
| 10-105 | 3" Carpet Seam Roller | 42 | 10-254-50 | Replacement Power Head | 36 |
| 10-106-3 | 3½" Solid Wheel Carpet Seam Roller | 42 | 10-254V | Power-Lok Stretcher Value Kit | 36 |
| 10-107-03 | Tailblade Replacement Unit | 38 | 10-258 | Power Stretcher Tail | 38 |
| 10-108 | Professional 2" Strip Cutter | 49, 51 | 10-260 | Deluxe Grip Pouch | 52 |
| 10-109 | Staple Hammer | 46 | 10-261 | Leather Tool Pouch | 49, 50 |
| 10-112 | All-Purpose Hammer Tacker | 46, 49 | 10-274 | 10" Aviation Snips | 52 |
| 10-114 | 20 oz. Ripping Hammer | 49, 88 | 10-279 | Topset Gouge | 63 |
| 10-117-04 | Powerhead Replacement Unit | 38 | 10-282G-2 | Deluxe Heat Bond Iron, Grooved Base | 41 |
| 10-117-05 | Replacement Blow Molded Carrying Case | 38 | 10-283 | Deluxe Heat Bond Iron | 41 |
| 10-121 | 8" Napping Shears | 47 | 10-286G | 6" Heat Bond Iron | 41 |
| 10-123 | 10" Carpet Shears | 47 | 10-294 | 4" Floor/Wall Scraper - 18" handle | 87 |
| 10-128 | Locking Pattern Matching & Seam Repair Stretcher | 38 | 10-296 | Stand-Up Scraper | 86 |
| 10-135 | 4" Awl | 44 | 10-303S | Chalk Reel | 20, 49 |
| 10-136 | Turning Tool | 44 | 10-321 | White Chalk, 8 oz. | 20, 49 |
| 10-140 | 30' Tape Measure | 48, 49 | 10-388 | Trimmer Blades - Bulk | 79 |
| 10-145 | Adhesive Dispenser | 41 | 10-410 | Adjustable Knee Kicker | 40 |

| Item # | Description | Page # |
|------------|---|--------|
| 10-412-09 | Replacement Bumper Pad | 39, 40 |
| 10-412-2 | Deluxe Knee Kicker | 40, 49 |
| 10-412-22 | Optional Molded Carrying Case | 40 |
| 10-412BKK | Deluxe Knee Kicker | 40 |
| 10-422-09 | Replacement Thick Bumper Pad | 40 |
| 10-422BK | Deluxe High Profile Knee Kicker | 40 |
| 10-434 | Heavy Duty Utility Blades | 79 |
| 10-436 | Heavy Duty Slotted Blades (Blue) | 78 |
| 10-438 | Heavy Duty Slotted Blades (Blue) - Bulk | 78 |
| 10-439 | Strip Cutter Blades | 79 |
| 10-440 | Hooked Blades | 79 |
| 10-442 | 4" Floor/Wall Scraper Blades | 78, 87 |
| 10-444 | Trimmer Blades | 79 |
| 10-458 | 8" Floor/Wall Scraper Blades | 78, 86 |
| 10-460 | 9" Tungsten Carbide Replacement Blade | 55, 78 |
| 10-464 | 13" Tungsten Carbide Replacement Blade | 55, 78 |
| 10-466 | 18" Tungsten Carbide Replacement Blade | 54, 78 |
| 10-468 | 25" Tungsten Carbide Replacement Blade | 54, 78 |
| 10-480 | Dual Air Glider | 52 |
| 10-482G | Cool Shield Heat Bond Iron | 41 |
| 10-483G | Cool Shield Heat Bond Iron | 41 |
| 10-501 | GT Knee Kicker | 39 |
| 10-505 | GelPro 505 Knee Kicker | 39 |
| 10-505-200 | GelPro Bumper Pad Kit | 39 |
| 10-510-3 | Base Molding Lifter | 49, 88 |
| 10-517 | Row Finder/Separator | 44, 49 |
| 10-520 | 2-3/4" Stair Tool | 44 |
| 10-521 | 3-1/2" Extra Wide Stair Tool | 44, 49 |
| 10-522-4 | EZ TUK Carpet Tucker | 44, 49 |
| 10-562 | Carpet Spreader | 38 |
| 10-575 | Heavy Cargo Dollies | 52 |
| 10-585 | 6" Duckbill Napping Shears | 47 |
| 10-586-3 | 7" Duckbill Napping Shears | 47, 49 |
| 10-600 | Professional Electric Stapler | 46 |
| 10-616-2 | Conventional Carpet Trimmer | 43, 49 |
| 10-617GT | GT Carpet Trimmer | 43 |
| 10-621GT | GT ONE STEP Carpet Trimmer | 43 |
| 10-645 | Calcium Chloride Moisture Test Kit | 70 |
| 10-646 | Calcium Chloride Moisture Test Kit (3 pack) | 70 |
| 10-700 | Hot Melt Glue Gun | 50 |
| 10-750 | Carpet Installation Kit | 49 |
| 10-751 | Economy Carpet Installation Kit | 49 |
| 10-800 | Deluxe Hot Melt Glue Gun | 50 |
| 10-801 | 10" Glue Sticks | 50 |
| 10-802 | 10" Glue Sticks | 50 |
| 10-810 | 1/16" x 1/16" x 1/16" (SQ), Wood Handle Trowel | 73 |
| 10-816 | 1/16" x 1/32" x 1/32" (U) Wood Handle Trowel | 73 |
| 10-820 | 3/32" x 3/32" x 3/32" (Flat-V) Wood Handle Trowel | 73 |
| 10-823 | 1/16" x 1/16" x 1/16" (SQ) Cushion Handle | 73 |
| 10-829 | 1/16" x 1/32" x 1/32" (U) Cushion Handle | 73 |
| 10-833 | 3/32" x 3/32" x 3/32" (Flat-V), Cushion Handle | 73 |
| 10-838 | 1/4" x 3/16" (V), TIGER TOOTH® Trowel | 73 |
| 10-847 | 16" Blade, Finishing Trowel, Cushion Handle | 72 |
| 10-895 | 12" Vinyl Tile Cutter | 62 |
| 10-900 | 12" Vinyl Tile Cutter | 62 |
| 10-905 | Multipurpose Wall Trimmer | 43 |
| 10-906 | Carpet Trimmer Adapter | 43 |
| 10-918 | 18" Vinyl Tile Cutter | 62 |

| Item # | Description | Page # |
|------------|--|--------|
| 10-920-6 | Professional Fixed Blade Utility Knife | 49, 77 |
| 10-931 | Linoleum Knife | 49, 77 |
| 10-935 | 35 lb. Roller | 61 |
| 10-950 | 75 lb. Roller | 61 |
| 10-952 | 100 lb. Roller | 61 |
| 10-952-04 | Replacement Transport Wheel Assembly Kit | 61 |
| 10-952-06 | Linoleum Roller Connector Tube | 61 |
| 10-955 | Extendible Floor Roller Roller | 61 |
| 10-960 | VCT Seam Roller | 63 |
| 10-980 | Wall Base Adhesive/Caulk Applicator | 63 |
| 10-981-25 | Snozzle Adhesive Applicator | 63 |
| 10-1600 | Mozart Weld Rod Trimmer | 63 |
| 10-2000-09 | Replacement Bumper Pad | 39, 40 |
| 10-2000GT | GT2000 XL Knee Kicker | 39 |
| 10-8678 | Mozart Trimmer Blades | 63 |
| 10-8679 | Mozart Weld Rod Spacer Claw 0.5mm | 63 |
| 10-8700 | Mozart Weld Rod Spacer Claw 0.7mm | 63 |
| 30-110 | 3/8" Chisel Point Staples | 46, 80 |
| 30-210 | 3/8" Divergent Point Staples | 46, 80 |
| 33-100 | 10 Gauge Concrete Nails | 80 |
| 50-540 | MaxGrip® Vinyl Installation Tape | 82 |
| 50-545 | Rug Traction™ Anti-Slip Rubber Tape | 82 |
| 50-550 | MaxGrip® Carpet Installation Tape | 82 |
| 50-555 | Duct Tape | 82 |
| 50-580 | Rug Gripper for Small Rugs | 83 |
| 50-582 | Rug Gripper for Small Rugs Value Roll | 83 |
| 50-584 | Rug Gripper For Accent Rugs | 83 |
| 50-588 | Carpet Gripper for Carpet Installation | 83 |
| 70-010-75 | Serenity Foam Underlayment | 66 |
| 70-025 | Unison® 2-in-1 Underlayment | 66 |
| 70-026 | Black Jack Underlayment (100 sq. ft. roll) | 66 |
| 70-026-XL | Black Jack Underlayment (600 sq. ft. roll) | 66 |
| 70-102-1 | First Step Premium 3-in-1 (630 sq. ft. roll) | 65 |
| 70-102-12 | First Step Premium 3-in-1 (100 sq. ft. roll) | 65 |
| 70-105 | AIRGUARD® Premium (100 sq. ft. roll) | 65 |
| 70-105-1 | AIRGUARD® Premium (630 sq. ft. roll) | 65 |
| 70-115 | Moisture Barricade | 68 |
| 70-120 | Waxed Paper Roll | 68 |
| 70-173 | Cork Pro Plus Underlayment | 67 |
| 70-175 | 1/4"(6mm) Natural Cork Sheets | 67 |
| 70-180 | Quiet Cushion Underlayment | 65 |
| 70-185 | Soft Stride Underlayment | 65 |
| 70-190 | Super Felt Underlayment (100 sq. ft. roll) | 66 |
| 70-193 | Super Felt Underlayment (360 sq. ft. roll) | 66 |
| 70-195 | Aquabar® "B" Moisture Vapor Barrier | 68 |
| 70-198 | SVS™ Silicone Vapor Shield™ | 68 |
| 402A | 16 Ga. Manual Floor Nailer | 56 |
| 418A | 18 Ga. Floor Nailer | 57 |
| 461A | 18 Ga. Floor Stapler | 57 |
| 465SLT | 16 Ga. 3-in-1 Floor Nailer/Stapler | 56 |
| 470A | 16 Ga. Floor Nailer | 56 |
| 472A | 15-1/2 Ga. Floor Stapler | 57 |
| 4702 | 2" L-Porta-Nails, 16 Ga. | 58 |
| 4703 | 1-3/4" L-Porta-Nails, 16 Ga. | 58 |
| 4704 | 1-1/2" L-Porta-Nails, 16 Ga. | 58 |
| 4723 | 2" Crown Staples, 15-1/2 Ga., BCS Type | 58 |
| 8850 | 12 Gauge Hanger Wire | 90 |
| 8851 | 18 Gauge Hanger Wire | 90 |

| Item # | Description | Page # | Item # | Description | Page # |
|----------|---|--------|----------|--|--------|
| 8854 | Light Duty Hanger Wire Installation Kit | 90 | 10268B | 13" Tile Cutter | 18 |
| 8855 | Wire-Fastening Nail Hooks | 90 | 10279Q | Grout Sealer Applicator | 25 |
| 8856 | 12 Eye Lag Screws for Wood Joists | 90 | 10281Q | Tile Spacers 1/8" | 34 |
| 8857 | Eye Lag Screws for Metal Joist | 91 | 10282Q | Tile Spacers 1/16" | 34 |
| 8858 | Eye Lag Screw Drill Adapter | 91 | 10284Q | Tile Spacers 3/16" | 34 |
| 8859 | Rivets | 91 | 10285Q | Wedge Tile Spacers | 34 |
| 8860 | Leveling Line | 91 | 10316Q | Tile Spacers 3/16" | 34 |
| 8861 | Grid Clamps | 91 | 10500 | 20" Big Clinker Tile Cutter | 16 |
| 8862 | Mounting Clips | 92 | 10552BR | 20" Tile Cutter | 17 |
| 8863 | Panel Clips | 92 | 10566Q | 5/16" Porcelain Diamond Drill Bit | 15 |
| 8864 | Light-Duty Ceiling Hooks | 92 | 10567 | Diamond Drill Bit Mounting Tape | 15 |
| 8865 | Grid Installation Kit | 92 | 10568Q | 1/4" Porcelain Diamond Drill Bit | 15 |
| 10003Q | Tile Nipper | 19 | 10569Q | 1-3/8" Porcelain Diamond Hole Saw | 15 |
| 10005Q | Tile Spacers 1/8" | 34 | 10570 | 1-3/8" Hole Saw Mounting Tape | 15 |
| 10006Q | Tile Spacers 1/16" | 34 | 10585QC | 3" Diamond Jigsaw Blade | 21 |
| 10010HD | 1/2" Tungsten Carbide Cutting Wheel | 17, 18 | 10586Q | Diamond Grit File | 22 |
| 10012Q | Grout Saw | 23 | 10600BR | 24" Big Clinker Tile Cutter | 16 |
| 10014Q | 3" Saber Saw Blade | 21 | 10630Q | 24" Big Clinker Tile Cutter | 16 |
| 10020Q | Grout Remover | 23 | 10710 | Multipurpose Trim Shears | 51 |
| 10022Q | Dual Grit Rubbing Stone | 22 | 10800 | 27" Big Clinker Tile Cutter | 16 |
| 10025Q | Replacement Blade Set | 23 | 10900Q | 35" Big Clinker Tile Cutter | 16 |
| 10026Q | Tile Spacers 1/8" | 34 | 14000 | 14" Tile Cutter | 18 |
| 10027Q | Tile Spacers 1/8" | 34 | 20836-24 | Grout and Tile Brush | 24 |
| 10032Q | 10" Contour Gauge | 20 | 20840Q | Grout Brush | 24 |
| 10033 | Wall Base Spreader | 74 | 20900Q | 14" Surface Scraper with Blade | 85 |
| 10060Q | Molded Rubber Grout Float 9-1/2" x 4" | 30 | 21000Q | 14" Replacement Blade | 85 |
| 10061Q | Gum Rubber Grout Float 9-1/2" x 4" | 30 | 21123Q | Tile Cutting Wheel | 16, 18 |
| 10062Q | Economy Rubber Grout Float 9" x 4" | 31 | 21125 | Tile Cutting Wheel | 16, 18 |
| 10063Q | Gum Rubber Grout Float 12" x 4" | 30 | 21591Q | Heavy Duty Grouting Gloves | 26 |
| 10067Q | ClearView 2-in-1 Tile Spacers 1/16" and 3/16" | 33 | 21643 | 4" Professional Handheld Tile Saw | 13 |
| 10068Q | ClearView 2-in-1 Tile Spacers 1/8" and 1/4" | 33 | 21661 | Replacement Paddle | 13 |
| 10073Q | Margin Float 6" x 2" | 31 | 21661 | Threaded Spiral Mixing Paddle | 14 |
| 10074Q | Premium Grout Float 9-1/2" x 4" | 30 | 21665 | Power Mixer with Paddle | 13 |
| 10075QC | 1/4" Diamond Drill Bit | 15 | 22400Q | 4" Torque Master XT | 10 |
| 10080QC | 5/16" Diamond Drill Bit | 15 | 22500 | 7" Tile Wet Saw | 9 |
| 10087QC | 1-3/8" Diamond Hole Saw | 15 | 22650Q | 650XT 7" Tile Wet Saw | 8 |
| 10091Q | Ceramic & Marble File | 22 | 22750Q | 7" Tile Wet Saw with Rear Support | 8 |
| 10096Q | Undercut Saw | 21 | 30002 | 12" Vinyl Tile Cutter | 62 |
| 10098Q | Slide-Lock Scoring Knife | 77 | 32010Q | Glass Tile Nipper | 19 |
| 10111Q | 1/16" x 1/32" x 1/32" (U), Economy | 73 | 32015-6 | Tile Nipper GT | 19 |
| 10113Q | 1/4" x 1/4" x 1/4" (SQ), Economy Trowel | 72 | 32024Q | Handheld Tile Cutter | 20 |
| 10114Q | 1/4" x 3/8" x 1/4" (SQ), Economy Trowel | 72 | 32035Q | Compound Tile Nipper | 19 |
| 10115Q | 3/16" x 5/32" (V), Economy Trowel | 72 | 38220 | Bolt Kit | 26 |
| 10116Q | 1/4" x 3/16" (V), Economy Trowel | 72 | 38221 | Toilet Bowl Wax Ring | 26 |
| 10117 | Tile Cutting Wheel | 17, 18 | 38223 | Johni-Ring® Large Wax Ring & Combo Kit | 26 |
| 10119Q | Tile Cutting Wheel | 17, 18 | 38229 | Toilet Installation Kit with 12" Connector | 26 |
| 10122 | 1/16" x 1/32" x 5/64" (U), Economy | 73 | 38232 | Fluidmaster® 12" SS Braided Toilet Connector | 26 |
| 10123-12 | 1/8" x 1/8" x 1/8" (SQ), Economy Trowel | 73 | 38233 | No Seep Wax Ring No. 50 | 26 |
| 10125 | 1/16" x 1/16" x 1/16" (SQ), Economy Trowel | 73 | 40009 | Flooring Mallet | 59 |
| 10137-12 | 1/8" x 1/8" x 1/16" (Flat-V), Economy Trowel | 73 | 40225 | Face Nail Shoe | 56 |
| 10142-12 | 1/4" x 1/4" x 1/14" (Flat-V), Economy Trowel | 73 | 40230 | Thin Flooring Shoe | 56 |
| 10143 | 3/8" x 5/16" (V), Economy Trowel | 73 | 40248 | Bamboo Flooring Shoe | 56 |
| 10144 | 1/4" x 3/16" (V), TIGER TOOTH® Economy Trowel | 73 | 41801 | 1-1/4" L-Porta-Nails, 18 Ga. | 58 |
| 10150TF | 4-in-1 Spreader, Square Notch | 74 | 41802 | 1-1/2" L-Porta-Nails, 18 Ga. | 58 |
| 10151 | 4-in-1 Spreader, V Notch | 74 | 41803 | 1-3/4" L-Porta-Nails, 18 Ga. | 58 |
| 10214Q | 14" Tile Cutter | 17 | 42103Q | 5" x 2" Margin Trowel - No Notch | 74 |
| 10220Q | 20" Tile Cutter | 17 | 42105-12 | 5" x 2" Margin Trowel - V Notch | 74 |
| 10267Q | 12" Tile Cutter | 18 | 42106-12 | 5" x 2" Margin Trowel - SQ Notch | 74 |

| Item # | Description | Page # |
|---------|--|--------|
| 42620 | Flooring Nail Set | 59 |
| 42629 | 2" T-Porta-Nails, 16 Ga. | 58 |
| 42640 | 1-1/2" T-Porta-Nails, 16 Ga. | 58 |
| 42660 | 2" T-Porta-Nails, 16 Ga. STAINLESS STEEL | 58 |
| 46196 | 1" Crown Staples, 18 Ga. | 58 |
| 46197 | 1-1/4" Crown Staples, 18 Ga. | 58 |
| 46198 | 1-1/2" Crown Staples, 18 Ga. | 58 |
| 47080 | 2" L-Porta-Nails, 16 Ga. STAINLESS STEEL | 58 |
| 47100 | Porta-Jack Pro Hardwood Flooring Jack | 54 |
| 47261 | 2" Crown Staples, 15-1/2 Ga., BCS Type | 58 |
| 47271 | 1-1/2" Crown Staples, 15-1/2 Ga., BCS Type | 58 |
| 47395 | Prefinished Flooring Shoe, Wide Profile | 56, 57 |
| 49708Q | 11" Blade, Finishing Trowel, Wood Handle | 72 |
| 49713Q | 1/4" x 1/4" x 1/4" (SQ), Wood Handle Trowel | 72 |
| 49714Q | 1/4" x 3/8" x 1/4" (SQ), Wood Handle Trowel | 72 |
| 49715Q | 3/16" x 5/32" (V), Wood Handle Trowel | 72 |
| 49716Q | 1/4" x 3/16" (V), Wood Handle Trowel | 72 |
| 49720Q | 1/2" x 1/2" x 1/2" (SQ), Wood Handle Trowel | 72 |
| 49725-1 | 1/4" x 1/4" x 1/4" (SQ), Wood Handle Trowel | 72 |
| 49727-1 | 1/2" x 1/2" x 1/2" (SQ), Wood Handle Trowel | 72 |
| 49730 | 3/16" x 1/4" x 1/2" (V), Wood Handle Trowel | 73 |
| 49732 | 1/8" x 1/8" x 1/8" (SQ), Wood Handle Trowel | 73 |
| 49736 | 1/16" x 1/16" x 3/32" (U), Wood Handle Trowel | 73 |
| 49737 | 1/8" x 1/8" x 1/16" (Flat-V), Wood Handle Trowel | 73 |
| 49738 | 1/16" x 1/32" x 5/64" (U), Wood Handle Trowel | 73 |
| 49739 | 1/4" x 1/4" x 1/4" (Flat V), Comfort Grip Trowel | 73 |
| 49795Q | 3/4" x 9/16" x 3/8" (U), Wood Handle Trowel | 72 |
| 49913Q | 1/4"x 3/16" (V), Stainless Steel Trowel | 72 |
| 49915Q | 1/4" x 1/4" x 1/4" (SQ), Stainless Steel Trowel | 72 |
| 49916Q | 1/4" x 3/8" x 1/4" (SQ), Stainless Steel Trowel | 72 |
| 49917Q | 3/16" x 5/32" (V), Stainless Steel Trowel | 72 |
| 49919Q | 1/2" x 1/2" x 1/2" (SQ), Stainless Steel Trowel | 72 |
| 60020SQ | 24" Heavy Duty Tile Saw | 7 |
| 60083 | 7" Professional Tile Saw | 7 |
| 60089Q | Master Cut™ 7" Portable Tile Saw | 9 |
| 60095 | Submersible Tile Saw Water Pump | 12 |
| 60098 | Submersible Tile Saw Water Pump | 12 |
| 60201 | Concrete Spreader with Brace | 70 |
| 60206 | 18" Surface Scraper with Blade | 85 |
| 60208 | 18" Replacement Blade | 85 |
| 60311 | Silver Tip Flagged Counter Cleaning Brush | 24 |
| 60315BR | Tile & Counter Brush | 24 |
| 60507 | Simulated Brick Cutter | 70 |
| 61024 | 24" Professional Tile Saw | 6 |
| 61205Q | Mixing Paddle | 14 |
| 61210Q | Universal Mixing Paddle | 14 |
| 61605 | 20 oz. Magnetic Hammer | 70 |
| 61606 | Magnetic Hammer-Head Only | 70 |
| 61613 | White Rubber Mallet | 25, 49 |
| 61900Q | 900XT 10" Professional Tile Saw | 6 |
| 62422 | Offset Grout Float 12" x 3" | 30 |
| 62801Q | 4" Razor Scraper Replacement Blades (10) | 87 |
| 62900Q | 4" Razor Scraper | 87 |
| 62901Q | 4" Razor Scraper Replacement Blades (5) | 87 |
| 62904Q | 8" Razor Scraper Replacement Blades | 86 |
| 62907Q | 8" Razor Scraper Replacement Blades | 86 |
| 62909Q | 8" Adjustable Razor Floor Stripper | 86 |
| 62965Q | Reversible Demolition Scraper | 85 |

| Item # | Description | Page # |
|------------|---|--------|
| 62970Q | Chisel Scraper | 87 |
| 62985Q | 2" Multi-Scraper | 87 |
| 62986Q | 2", 4" & 6" Multi-Scrapers Kit | 87 |
| 62995Q | 12" Power Scraper | 85 |
| 70005Q | XL All-Purpose Sponge | 27 |
| 70005Q-144 | XL All-Purpose Sponge | 27 |
| 70005Q-450 | XL All-Purpose Sponge | 27 |
| 70005Q-6D | XL All-Purpose Sponge | 27 |
| 70007Q | Scrubbing Sponge | 27 |
| 70010Q | Microfiber Polishing Sponge | 27 |
| 70018Q | Microfiber Epoxy Grout Cloth | 26 |
| 72000Q | 1/4" (6 mm) Natural Cork Roll | 67 |
| 72001Q | 1/2" (12mm) Natural Cork Sheets | 67 |
| 72003 | 1/4" (6 mm) Natural Cork Roll | 67 |
| 72004 | 3/16" (4mm) Natural Cork Sheets | 67 |
| 72005Q | 1/4" (6mm) Natural Cork Sheets | 67 |
| 72008Q | 1/8" (3 mm) Natural Cork Roll | 67 |
| 72025 | 1/8" (2.5mm) Natural Cork Sheets | 67 |
| 75000Q | Suction Cup | 24 |
| 75001Q | Thinset and Grout Mixing Paddle | 14 |
| 75006Q | 7" Heavy-Duty Floor Scraper with Blade | 86 |
| 75007Q | 7" Replacement Blade | 86 |
| 75009Q | Grout Grabber | 23 |
| 75011Q | Replacement Carbide Blades | 23 |
| 76000Q | Grout Bag | 27 |
| 76030Q | Cheese Cloth | 26 |
| 78200 | 5 Gallon Plastic Mixing Bucket | 13 |
| 78201 | Pour Spout Lid for 78200, 78217 & 78300 | 13 |
| 78208 | 3-1/2 Gallon Plastic Mixing Bucket | 13 |
| 78217 | 15 Litre Plastic Mixing Bucket | 13 |
| 78220Q | Tile Tool Value Kit | 25 |
| 78300 | 10 Litre Plastic Mixing Bucket | 13 |
| 79023-6 | Hard Cap Knee Pads | 29 |
| 79630Q | Comfort Grip Non-Slip Knee Pads | 28 |
| 79635TF | Foam Knee Pads | 29 |
| 79637BR | Contour Knee Pads | 29 |
| 79638BR | MAXFLEX Knee Pads | 28 |
| 79639Q | Neoprene Knee Pads | 29 |
| 79650Q | XL Professional Knee Pads | 28 |
| 80035BR | Compound Tile Nipper | 19 |
| 80620BR | Premium Tile Mallet | 25 |
| 81010BR | Microfiber Polishing Sponge | 27 |
| 81018BR | Microfiber Epoxy Grout Cloth | 26 |
| 82001BR | Tile Spacers 1/16" | 34 |
| 82002BR | Tile Spacers 1/8" | 34 |
| 82003BR | Tile Spacers 1/8" | 34 |
| 82004BR | Tile Spacers 3/16" | 34 |
| 82005BR | Tile Spacers 1/8" | 34 |
| 82006BR | Tile Spacers 1/8" | 34 |
| 82007BR | Tile Spacers 1/16" | 34 |
| 82008BR | Tile Spacers 3/16" | 34 |
| 82010BR | Wedge Tile Spacers | 34 |
| 82011BR | Tile Spacers 1/16" | 34 |
| 82100TF | 1/4" x 1/4" x 1/4" (SQ), Economy Trowel | 72 |
| 82101TF | 1/4" x 3/8" x 1/4" (SQ), Economy Trowel | 72 |
| 82102TF | 1/4" x 3/16" (V), Economy Trowel | 72 |
| 82103TF | 1/2" x 1/2" x 1/2" (SQ), Economy Trowel | 72 |
| 82104TF | 3/16" x 5/32" (V), Economy Trowel | 72 |

| Item # | Description | Page # | Item # | Description | Page # |
|-------------|---|--------|---------|---|--------|
| 82120BR | 1/4" x 3/8" x 1/4" (SQ), Wood Handle Trowel | 72 | 82902TF | 4" Razor Scraper Replacement Blades (5) | 87 |
| 82122BR | 1/4" x 1/4" x 1/4" (SQ), Wood Handle Trowel | 72 | 82903TF | 8" Razor Scraper Replacement Blades | 86 |
| 82123BR | 1/4" x 3/16" (V), Wood Handle Trowel | 72 | 82904TF | 4" Razor Scraper | 87 |
| 82124BR | 1/2" x 1/2" x 1/2" (SQ), Wood Handle Trowel | 72 | 82905TF | 8" Adjustable Razor Floor Stripper | 86 |
| 82125BR | 3/16" x 5/32" (V), Wood Handle Trowel | 72 | 82910BR | Reversible Power Scraper | 85 |
| 82126BR | 5-1/2" Pointing Trowel | 74 | 82995BR | 12" Power Scraper | 85 |
| 82127BR | 5" x 2" Margin Trowel - No Notch | 74 | 83200Q | 24" Bridge Saw | 5 |
| 82128BR | 5" x 2" Margin Trowel - V Notch | 74 | 83230Q | 830Z 30" Professional Bridge Saw | 5 |
| 82140BR | 1/4" x 3/8" x 1/4" (SQ), Stainless Steel Trowel | 72 | 85630BR | Comfort Grip Non-Slip Knee Pads | 28 |
| 82141BR | 1/2" x 1/2" x 1/2" (SQ), Stainless Steel Trowel | 72 | 85650BR | Pro Fit Knee Pads | 28 |
| 82142BR | 1/4" x 1/4" x 1/4" (SQ), Stainless Steel Trowel | 72 | 87067BR | Bulls•Eye 2-in-1 Tile Spacers 1/16" and 3/16" | 33 |
| 82143BR | 1/4"x 3/16" (V), Stainless Steel Trowel | 72 | 87068BR | Bulls•Eye 2-in-1 Tile Spacers 1/8" and 1/4" | 33 |
| 82144BR | 3/16" x 5/32" (V), Stainless Steel Trowel | 72 | 87720BR | LASH Tile Leveling Clips | 32 |
| 82145BR | 3/4" x 9/16" x 3/8" (U), Stainless Steel Trowel | 72 | 87725BR | LASH Tile Leveling Wedges | 32 |
| 82200TF | Economy Rubber Grout Float 9" x 4" | 31 | 89006BR | 7" Heavy-Duty Floor Scraper with Blade | 86 |
| 82201BR | Molded Rubber Grout Float 9-1/2" x 4" | 30 | 89007BR | 7" Replacement Blade | 86 |
| 82202BR | Gum Rubber Grout Float 9-1/2" x 4" | 30 | 89009BR | Grout Grabber | 23 |
| 82203BR | Gum Rubber Grout Float 12" x 4" | 30 | 89011BR | Replacement Carbide Blades | 23 |
| 82205BR | Epoxy Grout Float 9-1/2" x 4" | 31 | 89970BR | Chisel Scraper | 87 |
| 82207BR | Offset Grout Float 12" x 3" | 30 | 92220Q | 5-1/2" Pointing Trowel | 74 |
| 82208BR | Margin Float 6" x 2" | 31 | 99600Q | Cement Board Seam Tape – 2" x 50' roll | 83 |
| 82400BR | Pro Grout Saw | 23 | 99602 | Cement Board Screws: 1-1/4" | 80 |
| 82401TF | Grout Saw | 23 | 99603Q | Cement Board Seam Tape – 2" x 300' roll | 83 |
| 82402TF | Grout Remover | 23 | 99702 | LASH Tile Leveling Clips (Contractor Pack) | 32 |
| 82403TF | Undercut Saw | 21 | 99703 | LASH Tile Leveling Wedges (Contractor Pack) | 32 |
| 82404TF | Ceramic & Marble File | 22 | 99720Q | LASH Tile Leveling Clips | 32 |
| 82405TF | Spacer Remover | 34 | 99725Q | LASH Tile Leveling Wedges | 32 |
| 82407 | Grout and Tile Brush | 24 | 99750Q | Tile Leveling System Pliers | 32 |
| 82408TF | Grout Bag | 27 | 99760Q | LASH XL Tile Leveling Clips | 32 |
| 82410 | Handheld Tile Cutter | 20 | 99765Q | LASH XL Tile Leveling Wedges | 32 |
| 82413BR | 1-3/8" Porcelain Diamond Hole Saw | 15 | 99800BR | Horseshoe Spacers 1/16" | 34 |
| 82414BR | 5/16" Porcelain Diamond Drill Bit | 15 | 99801BR | Horseshoe Spacers 1/8" | 34 |
| 82417 | Rod Saw and Drill Bit | 21 | 99802BR | Horseshoe Spacers 3/16" | 34 |
| 82418TF | Tile Nipper | 19 | 99803BR | Leave-In Tile Spacers 1/16" | 33 |
| 82420 | Tile Sander | 22 | 99804BR | Leave-In Tile Spacers 1/8" | 33 |
| 82421BR | PRO Mixing Paddle | 14 | 99805BR | Leave-In Tile Spacers 3/16" | 33 |
| 82422TF | Thinset and Grout Mixing Paddle | 14 | 99806BR | Leave-In Tile Spacers 1/16" | 33 |
| 82423TF | Universal Mixing Paddle | 14 | 99807BR | Leave-In Tile Spacers 1/8" | 33 |
| 82424TF | Grout Sealer Applicator | 25 | 99808BR | Leave-In Tile Spacers 3/16" | 33 |
| 82426TF | Dual Grit Rubbing Stone | 22 | A09620 | Tile Scorer | 20 |
| 82427BR | Suction Cup | 24 | PC7725 | Brown Repair Putty | 58 |
| 82428 | Replacement Blade Set | 23 | PC7726 | Light Repair Putty | 58 |
| 82430TF | Heavy Duty Grouting Gloves | 26 | PC7727 | Light Red Repair Putty | 58 |
| 82431 | 10" Contour Gauge | 20 | PC7728 | Gray Repair Putty | 58 |
| 82432BR | Glass Tile Nipper | 19 | PC7729 | Gold Tones Repair Putty | 58 |
| 82433TF | Cement Board Seam Tape – 2" x 50' roll | 83 | PC7730 | Tan Repair Putty | 58 |
| 82434TF | Cement Board Seam Tape – 2" x 300' roll | 83 | PC7731 | Dark Red Repair Putty | 58 |
| 82605TF | Cement Board Screws: 1-1/4" | 80 | PC7732 | Dark Brown Repair Putty | 58 |
| 82606TF | Cement Board Screws: 1-1/4" | 80 | | | |
| 82607TF | Cement Board Screws: 1-5/8" | 80 | | | |
| 82608TF | Cement Board Screws: 1-5/8" | 80 | | | |
| 82700BR-144 | Grouting & Concrete Sponge | 27 | | | |
| 82700BR-36 | Grouting & Concrete Sponge | 27 | | | |
| 82700BR-3D | Grouting & Concrete Sponge | 27 | | | |
| 82701BR-144 | Grout Sponge & Haze Remover | 27 | | | |
| 82701BR-36 | Grout Sponge & Haze Remover | 27 | | | |
| 82900TF | 14" Surface Scraper with Blade | 85 | | | |
| 82901TF | 14" Replacement Blade | 85 | | | |

INDEX

By Description

| Description | Page # |
|---------------------------------------|------------|
| A | |
| Adhesive Dispenser | 41 |
| Air Glider | 52 |
| Aviation Snips | 52 |
| Awls | 44 |
| B | |
| Backerboard Scoring Knife | 77 |
| Base Molding Lifter | 49, 88 |
| Blades - BLACK WIDOW® Diamond | 11 |
| Blades - Continuous Rim Diamond | 11 |
| Blades - Glass Diamond Blade | 12 |
| Blades - Heavy Duty Slotted | 78 |
| Blades - Heavy Duty Utility | 79 |
| Blades - Hooked | 79 |
| Blades - Jamb Saw | 45 |
| Blades - Laminate Cutters | 54, 78 |
| Blades - Masonry | 45 |
| Blades - Scraper | 78, 87 |
| Blades - Scrapers | 85-87 |
| Blades - Segmented | 12, 70 |
| Blades - Strip Cutter | 79 |
| Blades - Strippers | 86 |
| Blades - Trimmer | 79 |
| Blades - Turbo | 12, 70 |
| Brick Cutter - Simulated | 70 |
| Bridge Saws | 5 |
| Buckets - Mixing | 13-14 |
| C | |
| Calcium Chloride Moisture Test Kit | 70 |
| Carpet Pullers | 90 |
| Carpet Shears - Carpet | 47 |
| Carpet Trimmers | 43, 49 |
| Case - Seaming Iron | 48 |
| Caulk Gun | 63 |
| Ceiling Hooks | 92 |
| Cement Board Seam Tape | 83 |
| Chalk | 20, 49 |
| Chalk Reel | 20, 49 |
| Cheese Cloth | 26 |
| Cleats - L Head | 58 |
| Cleats - T Head | 58 |
| Concrete Spreader with Brace | 70 |
| Contour Gauges | 20 |
| Cork Underlayments | 67 |
| Counter Brushes | 24 |
| Cushion Back Cutters | 43, 44, 49 |
| Cutting Wheels - Tile Cutters | 16, 18 |
| D | |
| Dollies | 52 |
| Drill Bits | 15 |
| E | |
| E•Z Slides | 52 |
| Eye Lag Screw Drill Adapter | 91 |
| F | |
| Fasteners | 58 |
| Floats | 30 |
| Flooring Jacks | 54 |
| G | |
| Glue Guns | 50 |
| Glue Sticks | 50 |
| Grid Clamps | 91 |
| Grout Bags | 27 |
| Grout Brushes | 24 |
| Grout Cloth - Microfiber Epoxy | 26 |
| Grout Grabber | 23 |
| Grout Removers | 23 |
| Grout Saws | 23 |
| Grout Sealer Applicator Bottles | 25 |
| Grouting Gloves | 26 |
| H | |
| Hammer - Magnetic | 70 |
| Hammer - Ripping | 49, 88 |
| Hammer Tacker | 46, 49 |
| Hanger Wires | 90 |
| Heat Bond Irons | 41 |
| Heat Guns | 63 |
| Hole Saws | 15 |
| Horseshoe Spacers | 34 |
| J | |
| Jamb Saws | 45 |
| Jigsaw Blades | 21 |
| K | |
| Karpet Kart | 52 |
| Kits - Calcium Chloride Moisture Test | 70 |
| Kits - Carpet Installation | 49 |
| Kits - Flooring Installation | 59 |
| Kits - Grid Installation | 92 |
| Kits - Hanger Wire Installation | 90 |
| Kits - Putty | 58 |
| Kits - Scrapers | 87 |
| Kits - Tile Tool | 25 |
| Knee Kickers | 39-40 |
| Knee Pads | 28-29 |
| Knives | 49, 76-77 |
| L | |
| Laminate Cutters | 54-55 |
| LASH Tile Leveling Clips | 32 |
| Leveling Lines | 91 |
| Linoleum Knife | 49, 77 |
| Loop Pile Cutters | 43, 49 |

M

| | |
|------------------------------|----|
| Mallets - Flooring | 59 |
| Microfiber Epoxy Grout Cloth | 26 |
| Mixers | 13 |
| Mixing Paddles | 13 |
| Moisture Vapor Barriers | 68 |
| Mounting Clips | 92 |

N

| | |
|---------------------|--------|
| Nail Driving Bar | 46, 49 |
| Nail Hooks | 90 |
| Nail Sets | 59 |
| Nailers - Manual | 56 |
| Nailers - Pneumatic | 57 |
| Nails - Concrete | 80 |

P

| | |
|----------------|----|
| Panel Clips | 92 |
| Pull Bars | 59 |
| Putty - Repair | 58 |

R

| | |
|-----------------------|------------|
| Rivets | 91 |
| Rod Saws | 21 |
| Rollers | 61 |
| Row Finder/Separators | 38, 44, 49 |
| Rubber Mallets | 25, 49 |
| Rubbing Stones | 22 |
| Rug Gripper | 83 |

S

| | |
|-----------------------------|--------|
| Saber Saw Blades | 21 |
| Scrapers | 85-87 |
| Screws - Cement Board | 80 |
| Screws - Eye Lag for Metal | 91 |
| Screws - Eye Lag for Wood | 90 |
| Seam Roller - VCT | 63 |
| Seam Rollers | 42, 49 |
| Shears - Duckbill Napping | 47 |
| Snuzzle Adhesive Applicator | 63 |
| Spacer Removers | 34 |
| Spacers | 33-34 |
| Spacers - Laminate Wedge | 59 |
| Sponges | 27 |
| Stair Tools | 44, 49 |
| Staplers | 46 |
| Staplers - Manual | 57 |
| Staplers - Pneumatic | 57 |
| Staples - Chisel Point | 46, 80 |
| Staples - Crown | 58 |
| Staples - Divergent Point | 46, 80 |
| Stretchers | 36-38 |
| Strip Cutter | 49, 51 |
| Stripper - Floor | 86 |
| Suction Cups | 24 |

T

| | |
|-----------------------------|------------|
| Tape - Anti-Slip Rubber | 82 |
| Tape - Carpet Installation | 82 |
| Tape - Cement Board Seam | 83 |
| Tape - Duct | 82 |
| Tape - Vinyl Installation | 82 |
| Tape Measures | 48, 49 |
| Tapping Blocks | 59 |
| Tile Cutters | 16-18 |
| Tile Cutters - Handheld | 20 |
| Tile Files | 22 |
| Tile Leveling System Pliers | 32 |
| Tile Nippers | 19 |
| Tile Sanders | 22 |
| Tile Saws - Handheld | 13 |
| Tile Saws - Portable | 7-10 |
| Tile Saws - Professional | 6-7 |
| Tile Scorer | 20 |
| Toilet Installation Kits | 26 |
| Tool Box | 48, 49 |
| Tool Pouches | 49, 50, 52 |
| Topset Gouge | 63 |
| Trim Shears | 51 |
| Trowels | 72-74 |
| Turning Tools | 44 |

U

| | |
|---------------|-------|
| Undercut Saw | 21 |
| Underlayments | 65-67 |

V

| | |
|-------------------|----|
| Vinyl Tile Cutter | 62 |
|-------------------|----|

W

| | |
|-----------------------|----|
| Water Pump - Tile Saw | 12 |
| Wedge Tile Spacers | 34 |
| Weld Rod Trimmers | 63 |

QEP®, LASH®, Black Widow®, Brutus®, Porta-Nails® and Suspend-It® are registered trademarks of Q.E.P. Co., Inc.

Roberts®, AirGuard®, Cool Shield®, the e® logo, Golden Touch®, Max Grip®, Quiet Cushion®, Soft Stride®, Super Felt®, Tiger Tooth® and Unison® are registered trademarks of Roberts Consolidated Industries, Inc.

Vitrex® is a registered trademark of Q.E.P. Co. U.K. Limited (a Q.E.P. Company)

Aquabar® "B" is a registered trademark of Fortifiber Building Systems Group

CRI® is a registered trademark of Carpet and Rug Institute

DUO-FAST® is a registered trademark of Illinois Tool Works Inc.

DUROCK® is a registered trademark of United States Gypsum Company

Fluidmaster® is a registered trademark of Fluidmaster, Inc.

HardieBacker® is a registered trademark of James Hardie Technology Limited

johni-ring® is a registered trademark of Hercules Chemical Company, Inc.

LEXAN® is a registered trademark of Sabic Innovative Plastics IP B.V.

Microban® and Microban Antimicrobial Protection® are registered trademarks of Microban Products Company

Primpact® is a registered trademark of Laboratoire Primattech Inc.

Rug Gripper™ is a trademark of Optimum Technologies, Inc

SVS™ and Silicone Vapor Shield are trademarks of AllGlobe Inc.

VELCRO® is a registered trademark of Velcro Industries



1001 Broken Sound Parkway, NW | Suite A
Boca Raton, Florida 33487

www.qepcorporate.com

www.qep.com www.robertsconsolidated.com www.porta-nails.com

For more information call 866-435-8665