

Powr-Flite[®]

OPERATOR'S MANUAL & PARTS LIST

Comfort Pro FREEDOM Backpack Vacuum CPF6 Series



**WARNING: OPERATOR MUST READ AND UNDERSTAND THIS MANUAL
COMPLETELY BEFORE OPERATING THIS EQUIPMENT.**

Save These Instructions

NOTES

Model Number: _____

Serial Number: _____



Date of Purchase: _____

Retain this manual as a permanent record of your purchase.

INTRODUCTION

Check the carton for shipping damage. Carefully unpack and inspect your new Powr-Flite vacuum for shipping damage. Each unit is tested and thoroughly inspected prior to shipping. If damage is discovered, immediately notify the transportation company that delivered your machine and request an inspection. As a manufacturer, we are unable to act upon any claim for concealed damage; you must originate the claim. Be sure to keep the carton, packing inserts, packing lists, and carrier's receipt until the inspector has verified your claim.

Introduction3
Safety Instructions4
Storage4
Grounding Instructions.....6
Operating Instructions7
Troubleshooting 10
Machine Specifications..... 11
Schematic and Parts List..... 13

	PROTECT THE ENVIRONMENT
	Please dispose of packaging materials in an environmentally safe way according to local waste disposal regulations.
	Always remember to recycle

MANUAL

This manual has important information for the use and safe operation of the Comfort Pro. Read this manual carefully before starting the machine. Keep the manual available at all times and instruct all operators to read this manual.

REPLACEMENT / ACCESORIES	
MODEL	COMFORT PRO 6 - CPF6S & CPF6P
BATTERY	X1200
CHARGER	X1194
MICRO HEPA FILTER BAG (10 PK)	X9678
CLOSED MOUTH PAPER BAG (10 PK)	X9735
OPEN MOUTH PAPER BAG (10 PK)	X9737
MICRO CLOTH BAG	X9679
INLET FILTER	X9683
EXHAUST FILTER	X9682
REPLACEMENT BRUSH STRIP FOR POWR-GLIDE	CT192

IMPORTANT SAFETY INSTRUCTIONS

Save These Instructions

SAFETY WARNINGS AND PRECAUTIONS

 **WARNING!** Read all instructions before using. Save these instructions. Following the cleaning instructions will prolong the life of your Powr-Flite vacuum.

When using an electrical appliance, basic precautions should always be followed.

1. Use only as instructed in this manual. Use only the recommended attachments and replacement parts.
2. Do not use outdoors or on wet surfaces.
3. Do not use to pick up liquids. This vacuum is for Dry Pickup only.
4. Do not allow to be used as a toy. Close attention is necessary when used by or near children.
5. If the unit is not working as it should, has been dropped, damaged, left outdoors, or exposed to water, return it to a service center before using.
6. Do not vacuum up hard or sharp objects, as they may damage the hose, vacuum bag or the vacuum motor.
7. Do not use without paper vacuum bag, cloth bag and filters in place.
8. Do not operate the vacuum while it is standing on high-pile carpet. The exhaust airflow is restricted and will cause the unit to overheat.
9. Do not put any objects into openings. Do not use with any opening blocked. Keep free of dust, lint, hair and anything that might reduce airflow.
10. Keep hair, loose clothing, fingers, and all parts of body away from openings and moving parts.
11. Use with extra care when cleaning stairs.
12. Do not vacuum flammable or combustible materials or anything that is burning or smoking, such as cigarettes, matches, or hot ashes.
13. Do not use with dust bag not in place.
14. Sparks inside the motor can ignite flammable vapors or dust. To reduce the risk of fire or explosion, do not use near combustible liquids, gases, or dusts, such as gasoline or other fuels, lighter fluid, cleaners, oil-based paints, or natural gas.
15. To reduce the risk of inhaling toxic vapors do not vacuum or use near toxic or hazardous materials.
16. Keep children and unauthorized persons away from the vacuum when in use.
17. This machine is not intended for use by persons with reduced physical, sensory or mental capabilities, or lack of experience and knowledge.
18. Do not attempt to service the vacuum yourself. Repair by anyone other than an authorized repair service center may void the warranty.

STORAGE

Always store the vacuum in cool, dry place.

SAFETY WARNINGS AND PRECAUTIONS

 **WARNING!**

BATTERY AND CHARGING SYSTEM:

To reduce the risk of electric shock, fire, battery explosion, or injury, use appliances only with specifically designed battery packs.

1. Use only Powr-Flite charger X1194 and Powr-Flite battery pack X1200. Use of any other battery packs may create a risk of injury and fire.

800.880.2913

2. Disconnect the battery pack from the machine before making any adjustments, changing accessories or storing machine.
3. **DO NOT** expose battery packs to temperatures above 122°F (50°C). Never leave battery packs in automobiles on hot days, where temperatures can be much higher than the outside temperature.
4. **DO NOT** use or store vacuum or batteries in wet or moist conditions, or with flammable or combustible materials.
5. **DO NOT** charge batteries or store battery for extended periods, 1 month or more, in temperatures above 90°F (32°C) or below 40°F (5°C).
6. When charging, make sure that the charger has at least 6 inches of clearance on all sides. Adequate airflow is required to cool the charger when in use.
7. Connect charging cord to a properly grounded outlet only. See Grounding Instructions.
8. **DO NOT** use a damaged cord or plug for charging.
9. **DO NOT** pull on charger's cord to unplug. Grasp and pull the plug, not the cord.
10. **DO NOT** handle the charger's cord plug with wet hands when inserting into electrical outlet.
11. Keep sparks and flames away from batteries. **DO NOT** smoke near batteries or charger.
12. **DO NOT** charge the unit outdoors.
13. **DO NOT** attempt to repair, service, or modify the battery system or charger. Have servicing performed by a qualified repair person using only identical replacement parts. This will ensure that the safety of the product is maintained. Contact Powr-Flite Customer Service with any issues.
14. **DO NOT** short-circuit the battery or charger terminals with conductive items such as paper clips. This can deliver high current, resulting in heat and fire.
15. **DO NOT** crush, drop, incinerate or damage the battery pack. **DO NOT** use a battery pack that has been damaged in any way. **DO NOT** incinerate the battery even if it is severely damaged or nonworking. The battery can explode in a fire.
16. Under abusive conditions, liquid may be ejected from the battery; avoid contact. If contact accidentally occurs, flush with water. If liquid contacts eyes, seek additional medical help. Liquid ejected from the battery may cause irritation or burns.
17. Follow all charging instructions and do not charge the battery pack or appliance outside of the temperature range specified in the instructions. Charging improperly or at temperatures outside of the specified range may damage the battery and increase the risk of fire.
18. Do not modify or attempt to repair the appliance or the battery pack (as applicable) except as indicated in the instructions for use and care.

CAUTION

To avoid damage to the battery contacts, turn off power switch before reconnecting the battery. Battery must be fully engaged to insure proper electrical connection.

INSTALLING BATTERY PACK INTO VACUUM

1. Holding battery by the front, carefully slide the battery into lower housing until it clicks in place (Fig. A).
2. Connector is spring-loaded. Battery will need to be pushed fully into position. (Fig. B)

BATTERY FUEL GAUGE

The battery fuel gauge indicates the approximate run time remaining on the battery. When the battery button is pressed, one to four indicators will light up, indicating the approximate battery charge remaining (Fig. C) as follows:

- All 4 lights on: Full Charge
- 3 lights on: 70% Charge
- 2 lights on: 45% Charge
- 1 light on: 25% Charge
- 1 light on and blinking: Low battery, charge when possible



CHARGER GROUNDING INSTRUCTIONS

THE COMFORT PRO FREEDOM BATTERY CHARGER MUST BE GROUNDED. If the charger should malfunction or stop working, grounding provides a path of least resistance for electrical current, thereby reducing the risk of electrical shock. This unit is equipped with a cord that has an equipment-grounding conductor and grounding plug. The plug must be inserted in an appropriate outlet that is properly installed and grounded in accordance with all local codes and ordinances. Cutting off the ground wire or using a cord that is not equipped with a ground plug will void the warranty on the unit, and Powr-Flite will accept NO liability associated with the unit.

⚠ WARNING! Improper connection of the equipment-grounding conductor can result in a risk of electric shock. Check with a qualified electrician or service person if you are in doubt as to whether the outlet is properly grounded. Do not modify the plug provided with the appliance. If it will not fit the outlet, have a proper outlet installed by a qualified electrician.

The vacuums are for use on a nominal 120-volt circuit, and have a grounded plug that looks like the plug illustrated in Figure A. A temporary adapter that looks like the adapter illustrated in Figure B and C may be used to connect this plug to a 2-pole receptacle as shown in Figure B if a properly grounded outlet is not available. The temporary adapter should be used only until a properly grounded outlet (Figure A) can be installed by a qualified electrician. The green colored rigid ear, lug, or the like, extending for the adapter must be connected to a permanent ground such as a properly grounded outlet box cover. Whenever the adapter is used, it must be held in place by a metal screw.

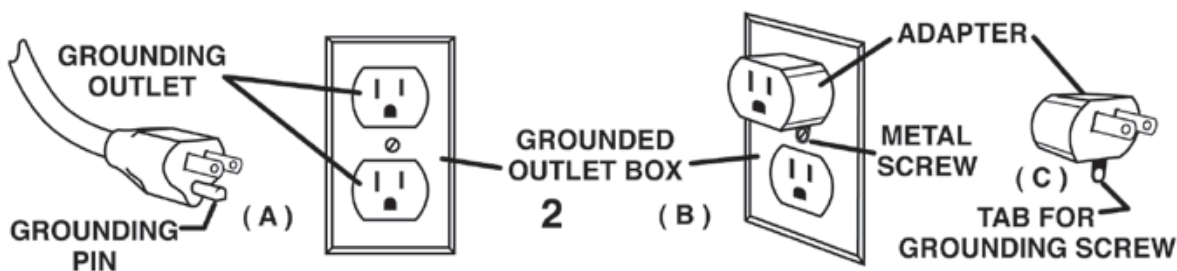

Note: In Canada, the use of a temporary adapter is not permitted by the Canadian Electrical Code.

⚠ WARNING! The replacement or repair of damaged wiring should only be performed by a qualified electrician or service engineer from the manufacturer or authorized service center.

OPERATING INSTRUCTIONS

IMPORTANT! PERFORM PROPER INSTALLATION OF HEPA BAGS AND CORD IN COMFORT PRO BACKPACK VACUUMS.

Please read the following instructions carefully. They will help to get the best performance from this professional commercial vacuum cleaner and to maintain it in optimum condition. Always make sure the main power of the vacuum is off and the unit is not plugged in when doing any maintenance on the vacuum.

PREPARING TO VACUUM

1. Remove vacuum hose from top of unit. (Fig. 1)
2. Release the two latches and lift off lid. (Fig. 2)
3. Ensure Micro Cloth bag is fully seated on Comfort Pro tank housing. (Fig. 3)
4. Fold the bottom 2" of the HEPA bag up and hold into place. (Fig. 4)
5. Insert HEPA bag inside of micro cloth bag. (Fig.5)
6. Squeeze bag just below the cardboard collar and drop onto rubber gasket. (Fig. 6)
7. Ensure that white bag is not protruding under cardboard collar. (Fig. 7)
8. NOTE: Cardboard must be properly seated inside gasket groove. Cardboard will be flush with gasket. (Fig. 8)
9. Replace lid, lock down the two latches and install hose. (Fig. 9).



1.



2.



3.



4.



5.



6.

OPERATING THE BACKPACK VACUUM

1. Fasten the ends of the top and bottom wand together.
2. Attach the floor tool to end of wand. Align the steel ring with the groove on the floor tool to ensure a secure fit and tighten.
4. Turn the unit on, and proceed with vacuuming.
5. The on/off switch is conveniently located on the body of the backpack vacuum (Fig. 10)



7.



8.



9.



10.

PROPER VACUUMING MOTION FOR LARGE AREAS

1. Begin with the wand parallel to your body.
2. Draw the top of the wand in toward your waist and twist at the waist walking backward or forward, in a side-to-side motion.
3. The motion is similar to mopping and keeps the upper body and arms from tiring.

! WARNING! Always unplug machine before cleaning, or making any adjustments or repairs.

The backpack vacuum has four levels of filtration: the paper vacuum bag, a micro cloth filter, a pre-motor filter and an exhaust filter. These bags and filters capture fine dust particles and protect the motor from dirt. It is important to replace the paper bag when it is no more than 1/2 full and to clean the filters on a regular schedule and replace as necessary.

Paper Vacuum Bag

1. Remove paper bag. Insert a new paper bag into the cloth bag, making sure the cardboard disk is centered on the flexible sealing ring. When you replace the lid, the short nozzle in the center of the lid will be closed over the central hole of the cardboard disk of the paper vacuum bag providing a seal. (Fig. A)

2. Replace the lid. Fasten latches and replace hose. (Figs. C-D)

Micro Cloth Filter

After each use, the cloth filter bag should be inspected. Hand wash the cloth filter bag every 6 months using cold water and no detergent. Line dry.

3. Remove the micro cloth bag, clean and replace. (Fig. B)

4. Replace paper vacuum bag and lid. Fasten latches and insert hose. (Figs. C-D)

Pre-Motor Filter

The pre-motor filter is located under the micro cloth filter. Inspect after each use. The filter can be washed using cold water and no detergent. Lay flat to dry. Replace every 6 months.

5. Remove the lid, the paper vacuum bag, and the cloth bag to expose the pre-motor filter.

6. Remove the foam pre-motor filter from the dust compartment, clean and replace. If filter is extremely dirty, rinse out and air dry before replacing back into vacuum. (Fig. E)

7. Reinstall the cloth bag, the paper vacuum bag and replace the lid, fasten latches and insert the hose. (Figs. C-D)

Exhaust Filter

The exhaust filter is an easy-access washable, reusable post-motor filter located on the bottom of the vacuum. For average use of the vacuum, remove and clean the exhaust motor filter every 3 months. The filter can be washed using cold water and no detergent. Lay flat to dry. Replace once a year.

8. Remove the foam post motor filter, clean and replace.

9. Reinstall the filter at the bottom of the vacuum. (Fig. F)



Wearing the Backpack Vacuum

The backpack is designed to balance the weight of the vacuum on the hips, not the shoulders.

1. Adjust the VariQuick height adjuster to your back length.
2. Loosen all of the straps and place the vacuum on your back.

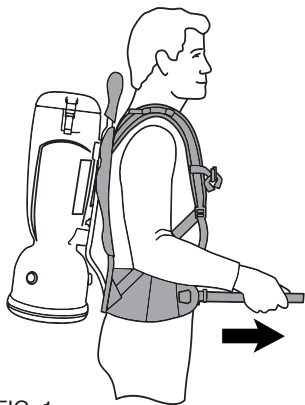

FIG. 1

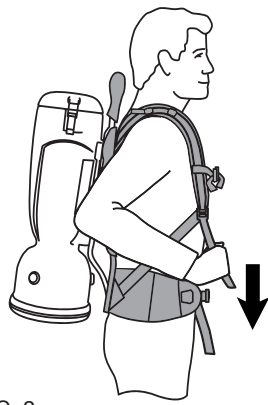

FIG. 2

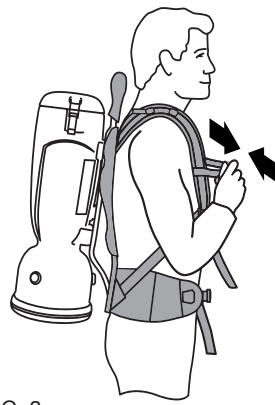

FIG. 3

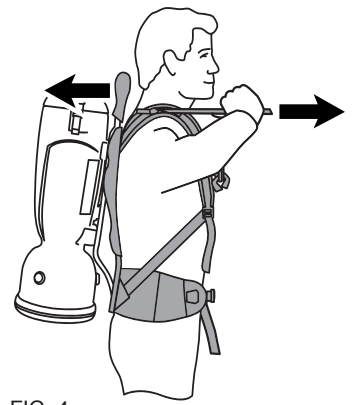

FIG. 4

3. Place the hip belt over your hip and connect the buckle. Your hip bones should be centered between the top and bottom of the belt. Pull the straps forward to tighten the hip belt. (Fig. 1)
4. Pull down the shoulder straps to tighten the backpack on your shoulders. (Fig. 2) Do not tighten too tight. The main weight of the vacuum should be on the hip belt. The anchor points of the shoulder straps should ideally be between the shoulder blades. Adjust the VariQuick height adjuster if necessary to properly fit the vacuum to your back length.
5. Adjust the sternum strap on a comfortable part of your chest and close the strap. (Fig. 3)
6. Loosen or tighten the stabilizer straps as needed, to fit your back. (Fig. 4)
7. Do final adjustments on the shoulder and stabilizer straps as needed to balance the weight of the vacuum on the hips.

TROUBLESHOOTING

1. If the vacuum will not operate, check the following:
 - a. The battery pack connection to the vacuum.
 - b. The battery pack is charged.
 - c. That the switch is in the “on” position and functioning properly.
2. If the battery pack is not charging, check that the charger is plugged into 120 Volt outlet and that the battery is properly connected to the charger. Also check fuse in charger.
3. If the exhaust air from the bottom of the vacuum is warmer than usual, check, clean or replace all filters.
4. If loss of suction occurs, check the following:
 - a. Check that debris is not plugging the hose, wand, and/or floor tool.
 - b. Check, clean or replace both Intercept Micro and Micro Cloth filters.
 - c. Check that the hose cuffs are fitting tightly on the hose and are not cracked.
 - d. Check that the cap is properly attached to the vacuum body.
5. If the charger’s LED indicator is off and there is no output voltage when plugged in, check both ends of the power cord.



The backpack vacuum has been fitted with a thermal overload switch to protect the motor against damage should the airflow be blocked for extended periods. This may occur if the vacuum bag is overfull, the micro cloth bag is clogged, or if the vacuum hose or exhaust is blocked. The vacuum motor will stop before it can get too hot. If this happens, empty and thoroughly clean the vacuum bag and filters, or free any blockage and ensure that adequate airflow is restored. After the motor cools, you will be able to restart the machine – this may take up to 20 minutes.

SPECIFICATIONS



**Specifications and parts are subject to change without notice.
Please refer to www.Powr-Flite.com for the latest schematic drawing and parts list.**

PRODUCT SPECIFICATIONS		
MODEL	COMFORT PRO FREEDOM 6	COMFORT PRO FREEDOM 6 PREMIUM
ITEM#	CPF6S	CPF6P
TOOL KIT*	Standard	Hands-Free
BODY	High Density Polyethylene	High Density Polyethylene
DIMENSIONS (L X W X H)	10 in x 12.5 in x 26.5 in 25.4 cm x 31.8 cm x 67.3 cm	10 in x 12.5 in x 26.5 in 25.4 cm x 31.8 cm x 67.3 cm
MACHINE WEIGHT (LBS. / KG)	8.75 lbs. / 3.96 kg	8.75 lbs. / 3.96 kg
HARNESS WEIGHT (LBS. / KG)	3.2 lbs. / 1.45 kg	3.2 lbs. / 1.45 kg
BATTERY WEIGHT (LBS. / KG)	5.75 lbs. / 2.61 kg	5.75 lbs. / 2.61 kg
CORD LENGTH / TYPE	50 ft. / 15 m, direct plug	50 ft. / 15 m, direct plug
CAPACITY (QUARTS / LITERS)	6 qt. / 5.69 l	6 qt. / 5.69 l
FILTRATION	5 stage HEPA	5 stage HEPA
WATERLIFT	62 in. / 157 cm	62 in. / 157 cm
CFM /CMM	70 cfm / 1.98 cmm	70 cfm / 1.92 cmm
CLEANING PRODUCTIVITY	7,407 sq. feet per hour 688 sq. meters per hour	7,407 sq. feet per hour 688 sq. meters per hour
SOUND LEVEL	62 dBa	62 dBa
BATTERY RUN TIME	55 minutes	55 minutes
BATTERY CHARGE TIME	2.5 hours	2.5 hours
APPROVALS	CRI Silver Level Approved	CRI Silver Level Approved

TOOL KITS

Standard Tool Kit

Fits: CPF6S

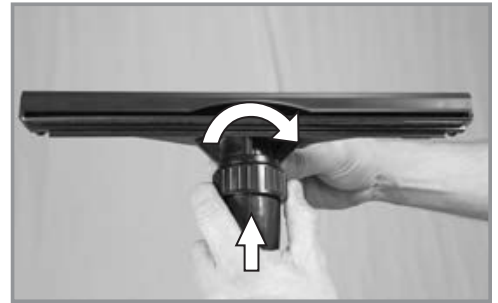
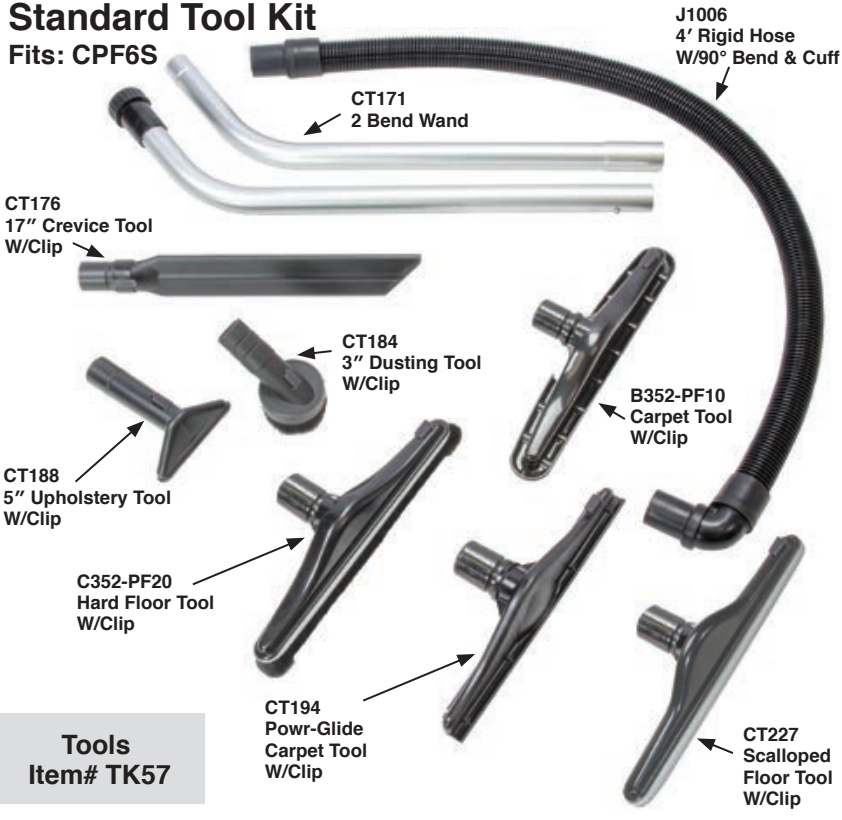

Install the floor tool to the end of the wand. Align the brass ring with the groove on the floor tool to ensure a secure fit.

Premium Tool Kit

Fits: CPF6P



To properly attach one-bend adapter (#J1007) to the one-bend telescopic wand (#CT170):

Install the adapter on the wand with the line pointing to the center of the notches on the wand.

Install floor tool onto adapter and tighten plastic nut to secure.

TOOLS SCHEMATICS AND PARTS LIST

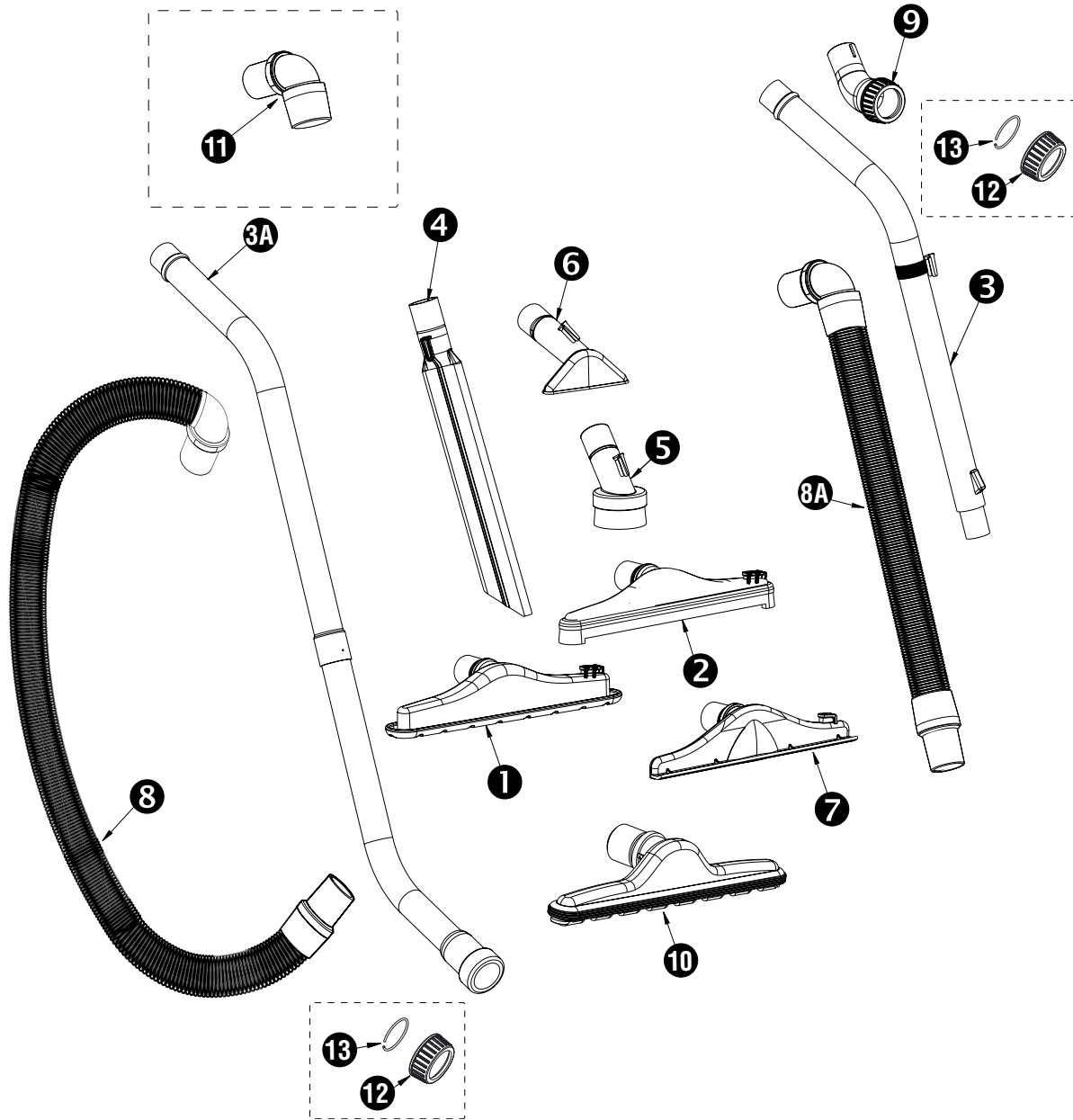

STANDARD TOOL KIT - FITS CPF6S			
ITEM	DESCRIPTION	PART NO.	QTY
1	CARPET TOOL W/CLIP	B352-PF10	1
2	HARD FLOOR TOOL W/CLIP	C352-PF20	1
3A	DOUBLE BEND WAND	CT171	1
4	17" CREVICE TOOL W/CLIP	CT176	1
5	3" DUSTING TOOL W/CLIP	CT184	1
6	5" UPHOLSTERY TOOL W/CLIP	CT188	1
7	POWR-GLIDE CARPET TOOL W/CLIP	CT194	1
8	4' CRUSH PROOF HOSE W/90° CUFF	J1006	1
10	14" SCALLOPED FLOOR TOOL	CT227	1
11	90 DEGREE SWIVEL CUFF	J1004	1
12	NUT	J1009	1
13	RING	J1010	1

PREMIUM TOOL KIT - FITS CPF6P			
ITEM	DESCRIPTION	PART NO.	QTY
1	CARPET TOOL W/CLIP	B352-PF10	1
2	HARD FLOOR TOOL W/CLIP	C352-PF20	1
3	SINGLE BEND TELESCOPING WAND W/CLIP	CT170	1
4	17" CREVICE TOOL W/CLIP	CT176	1
5	3" DUSTING TOOL W/CLIP	CT184	1
6	5" UPHOLSTERY TOOL W/CLIP	CT188	1
7	POWR-GLIDE CARPET TOOL W/CLIP	CT194	1
8A	2' - 6' STRETCH HOSE W/90° CUFF	J1005	1
9	ONE BEND WAND ADAPTOR	J1007	1
10	14" SCALLOPED FLOOR TOOL	CT227	1
11	90 DEGREE SWIVEL CUFF	J1004	1
12	NUT	J1009	1
13	RING	J1010	1

SCHEMATIC

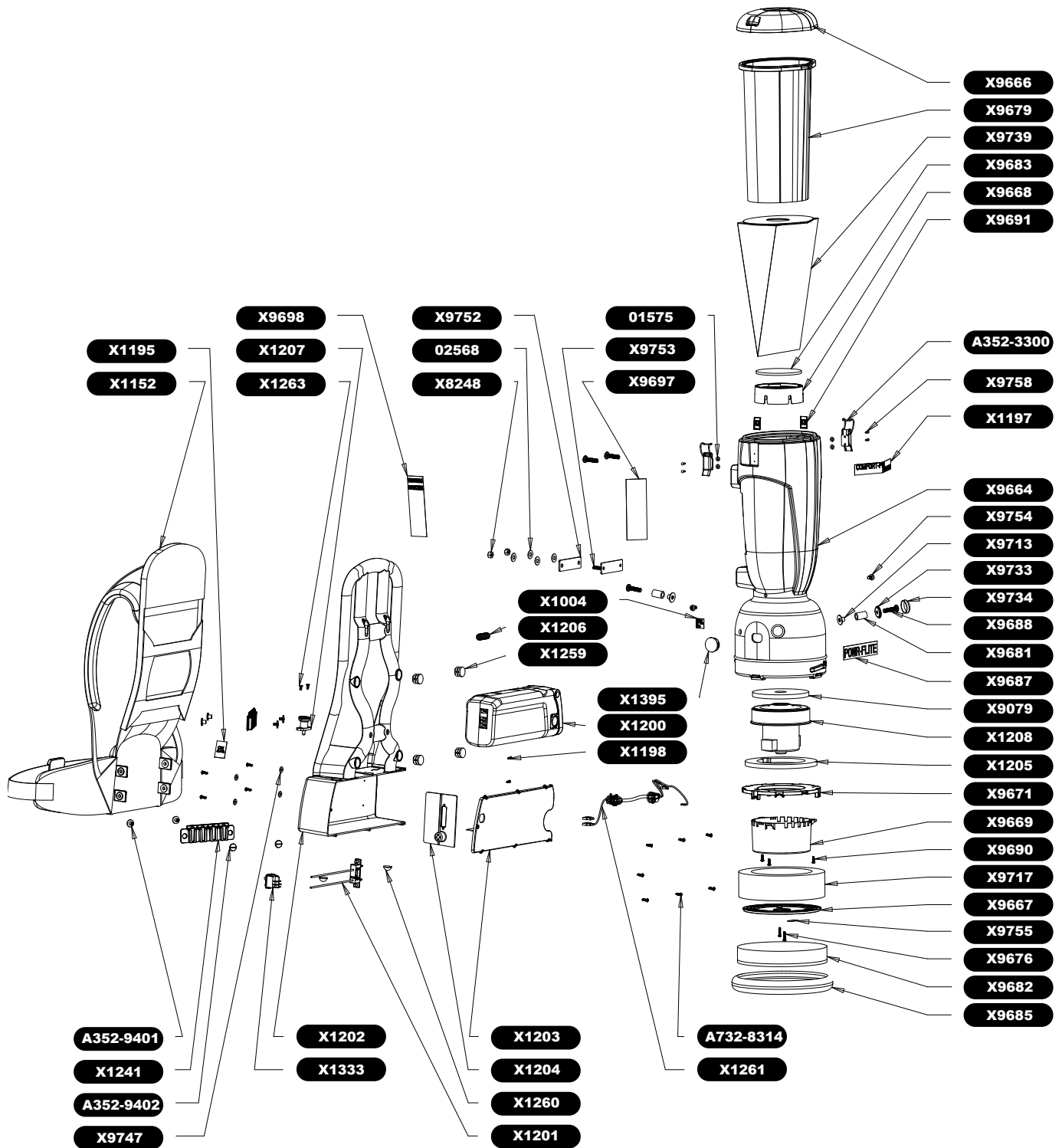

PARTS LIST

PART NO.	DESCRIPTION	QTY
02568	HARNESS MOUNTING WASHER	2
7CM004	WASHER 3/8 USS FLAT 18-8 SS	1
A352-3300	LID LATCH	2
A352-9401	FEMALE RIVOT FOR BELT PANEL	4
A352-9402	BELT PANEL MOUNTING SCREW	4
A732-8314	8-18 HI-LO SCREW	7
CPF-MAN	COMFORT PRO FREEDOM MANUAL	1
N/A	BAG FOR MACHINE	1
N/A	BOX TAPE	5
N/A	BUBBLE WRAP FOR CREVICE TOOL	1
PFBURDEN	BURDEN	23
X1004	SMALL MADE IN THE USA LABEL	1
X1152	DEUTER HARNESS	1
X1194	CHARGER, 36V 5 AMP LITHIUM ION	1
X1195	CRI SILVER LABEL	1
X1196	WARNING LABEL	1
X1197	COMFORT PRO LABEL	1
X1198	SCREW, #4 X .5" HIGH LOW (ZP) PHIL FLAT HEAD	2
X1200	SAMSUNG SDI BATTERY	1
X1201	SAMSUNG SDI BATTERY CONNECTOR	1
X1202	HARNESS FRAME	1
X1203	BATTERY BOX COVER	1
X1204	TERMINAL PLATE	1
X1205	MOTOR PLATE GASKET	1
X1206	BATTERY EJECT SPRING	1
X1207	SPRING LOADED PLUNGER	1
X1208	5.1" VACUUM MOTOR	1
X1241	BELT CLIP W/ RETAINER	2
X1260	RUBBER FOOT	2
X1261	FREEDOM POWER HARNESS	1
X1263	SCREW, 8-18 HIGH-LOW 3/8" PHIL FLAT HEAD ZP	2
X1333	DPST ROCKER SWITCH	1
X1395	PLUG, ROUND HOLE .187" DIA	1
X1523	SWITCH, MOMENTARY, 42VDC 40A INRUSH	1
X1526	CPF SWITCH MOUNTING BRACKET	1
X8248	NUT 5/16 LOCK W/ NYLON INSERT	2
X8257	6-32 NYLON LOCK NUT	2
X8449	WARRANTY CARD	1
X8450	POLY BAG FOR MANUALS	1
X8451	BOX LABEL	1
X8459	SERIAL LABEL	1
X9079	GASKET 3/8" DONUT MOTOR SEAL	1
X9664	HOUSING 6QT COMFORT VAC	1
X9666	6 QUART LID	1
X9667	EXHAUST FILTER PLATE	1
X9669	MOTOR SHIELD	1
X9671	MOTOR MOUNTING BRACKET	1

PART NO.	DESCRIPTION	QTY
X9676	8-18 3/4 LONG HI LO SCREW	2
X9679	6 QUART CLOTH BAG	1
X9681	RUBBER MOTOR MOUNT	3
X9682	EXHAUST FILTER	1
X9685	HOUSING BUMPER	1
X9687	POWR-FLITE LABEL	1
X9688	MOTOR MOUNTING BOLT	5
X9690	8-18 HI-LO SCREW	7
X9698	HARNESS LABEL	1
X9706	BACKPACK BOX	1
X9708	BOX FOR BACKPACK TOOLS	1
X9713	MOTOR MOUNTING WELDNUT	3
X9717	SOUND DAMPING FOAM RING	1
X9733	SCREW CAP BASE	2
X9734	SCREW CAP	2
X9739	6 QUART HEPA BAG	2
X9747	#10 USS FLAT WASHER BLACK	4
X9748	SCREW, 6-32 X 5/8 L FHD, BLK	2
X9750	WAND BOX COMFORT PRO	1
X9751	SIDE PAD CARDBOARD	1
X9752	HARNESS MOUNTING GASKET	1
X9753	STEEL MOUNTING PLATE	1
X9758	RIVET	4
X9760	6QT LID GASKET	1
X9936	BAG INSTALLATION SHEET	1

POWR-FLITE LIMITED WARRANTY

Powr-Flite will repair or exchange parts for your vacuum in the event of a manufacturing defect as follows:

PARTS: New or comparable rebuilt parts, for three years after original purchase. Lifetime warranty on molded body.

LABOR: Labor warranty for one year. Carry-in service can be obtained during the warranty period by taking your vacuum to an Authorized Powr-Flite Warranty Service Center.

IMPORTANT WARRANTY CONDITIONS: A purchase receipt or other proof of date of original consumer purchase also will be required before warranty service is rendered.

This warranty covers normal use and does not cover damage which occurs in shipment or failure resulting from alteration, accident, misuse, abuse, neglect, or improper maintenance.

STATEMENT: This warranty is not transferable and extends only to the original purchaser when a new Powr-Flite vacuum is purchased from an Authorized Powr-Flite Dealer. This warranty gives you specific legal rights, and you may have other rights that vary from state to state.

Powr-Flite[®]

A Tacony Company

3101 Wichita Court • Ft. Worth, TX 76140-1755
1-800-880-2913 • Fax: 1-817-551-0719 • www.Powr-Flite.com