

# Powr-Flite®

## OPERATOR'S MANUAL & PARTS LIST

### Comfort Pro Backpack Vacuum BP6 - BP10 Series



6 quart model



10 quart model



Hands free  
tool kit

**WARNING: OPERATOR MUST READ AND UNDERSTAND THIS MANUAL COMPLETELY BEFORE OPERATING THIS EQUIPMENT.**

**Save These Instructions**

## NOTES

Model Number: \_\_\_\_\_

Serial Number: \_\_\_\_\_

Date of Purchase: \_\_\_\_\_

**Retain this manual as a permanent record of your purchase.**

# INTRODUCTION

Check the carton for shipping damage. Carefully unpack and inspect your new Powr-Flite vacuum for shipping damage. Each unit is tested and thoroughly inspected prior to shipping. If damage is discovered, immediately notify the transportation company that delivered your machine and request an inspection. As a manufacturer, we are unable to act upon any claim for concealed damage; you must originate the claim. Be sure to keep the carton, packing inserts, packing lists, and carrier's receipt until the inspector has verified your claim.

**Introduction .....3**

**Safety Instructions .....4**

**Storage .....4**

**Grounding Instructions.....6**

**Operating Instructions .....7**

**Maintenance..... 11**

**Troubleshooting ..... 11**

**Machine Specifications..... 12**

**Schematic and Parts List..... 14**



**PROTECT THE ENVIRONMENT**

Please dispose of packaging materials in an environmentally safe way according to local waste disposal regulations.



Always remember to recycle

## MANUAL

This manual has important information for the use and safe operation of the Comfort Pro. Read this manual carefully before starting the machine. Keep the manual available at all times and instruct all operators to read this manual.

REPLACEMENT / ACCESORIES		
MODEL	COMFORT PRO 6 - BP6S & BP6P	COMFORT PRO 10 - BP10S & BP10P
MICRO HEPA FILTER BAG (10 PK)	X9739	X9737
CLOSED MOUTH PAPER BAG (10 PK)	X9735	X9736
OPEN MOUTH PAPER BAG (10 PK)	X9737	X9738
MICRO CLOTH BAG	X9679	X9692
INLET FILTER	X9683	X9683
EXHAUST FILTER	X9682	X9682
50' POWER CORD	X9714	X9714

# IMPORTANT SAFETY INSTRUCTIONS

## Save These Instructions

### SAFETY WARNINGS AND PRECAUTIONS



#### **WARNING!**

Read all instructions before using. Save These Instructions.

Following the cleaning instructions will prolong the life of your Powr-Flite vacuum.

When using an electrical appliance, basic precautions should always be followed.

1. Use only as instructed in this manual. Use only the recommended attachments and replacement parts.
2. Do not leave vacuum cleaner plugged in when not in use. Unplug vacuum before servicing.
3. Do not use outdoors or on wet surfaces.
4. Do not use to pick up liquids. This vacuum is for Dry Pickup only.
5. If the unit is not working as it should, has been dropped, damaged, left outdoors, or exposed to water, return it to a service center before using.
6. Do not vacuum up hard or sharp objects, as they may damage the hose, vacuum bag or the vacuum motor.
7. Do not use without paper vacuum bag, cloth bag and filters in place.
8. Do not operate the vacuum while it is standing on high-pile carpet. The exhaust airflow is restricted and will cause the unit to overheat.
9. Do not use with damaged cord or plug.
10. Do not kink or twist the power cord.
11. Do not pull or carry by the cord, use the cord as a handle, close a door on cord, or pull cord around sharp edges or corner. Do not run vacuum cleaner over cord. Keep cord away from heated surfaces.
12. Do not pull on the cord to unplug. Grasp and pull the plug, not the cord. Turn off the vacuum before unplugging.
13. Do not handle the cord, plug, switch or vacuum with wet hands.
14. Do not use outlets with inadequate current capacity.
15. Do not use an extension cord with this vacuum.
16. Do not put any objects into openings. Do not use with any opening blocked. Keep free of dust, lint, hair and anything that might reduce airflow.
17. Keep hair, loose clothing, fingers, and all parts of body away from openings and moving parts.
18. Use with extra care when cleaning stairs.
19. Do not vacuum flammable or combustible materials or anything that is burning or smoking, such as cigarettes, matches, or hot ashes.
20. Do not use with dust bag not in place.
21. Sparks inside the motor can ignite flammable vapors or dust. To reduce the risk of fire or explosion, do not use near combustible liquids, gases, or dusts, such as gasoline or other fuels, lighter fluid, cleaners, oil-based paints, or natural gas.
22. To reduce the risk of inhaling toxic vapors do not vacuum or use near toxic or hazardous materials.
23. Keep children and unauthorized persons away from the vacuum when in use.
24. This machine is not intended for use by persons with reduced physical, sensory or mental capabilities, or lack of experience and knowledge.
25. Do not attempt to service the vacuum yourself. Repair by anyone other than an authorized repair service center may void the warranty.
26. Store the vacuum indoors in a cool, dry area.

### STORAGE

Always store the vacuum in cool, dry place.

800.880.2913

# IMPORTANT SAFETY INSTRUCTIONS

## Save These Instructions

### CONSIGNES DE SÉCURITÉ ET PRÉCAUTIONS A PRENDRE



**DANGER!**

**Lisez toutes les instructions avant de l'utiliser . Conserver ces instructions . Suivre les instructions de nettoyage prolonger la vie de votre aspirateur Powr - Flite**

Lors de l'utilisation d'un appareil électrique, certaines précautions de base être suivies.

1. N'utiliser l'appareil que selon les instructions données dans ce manuel. N'utiliser que des accessoires et pièces détachées recommandées.
2. Ne pas laisser l'aspirateur branché après utilisation. Toujours le débrancher avant toute intervention sur la machine.
3. Ne pas l'utiliser à l'extérieur ou sur des surfaces mouillées.
4. Ne pas utiliser pour aspirer des liquides. l'appareil est uniquement destiné à aspirer de matières sèches
5. Si la machine ne fonctionne pas comme elle devrait, si elle a fait une chute, si elle est endommagée, si elle a été laissée à l'extérieur ou exposée à l'eau ou à l'humidité, rapporter la dans un centre technique avant de l'utiliser à nouveau.
6. Ne pas aspirer d'objets coupants ou trop durs, car ils pourraient endommager le flexible, le sac à poussière ou le moteur.
7. Ne pas utiliser sans sac à poussière, filtre tissu et les autres filtres, tous correctement ajustés.
8. Ne pas utiliser l'aspirateur sur une moquette ou tapis à poils longs le flux d'extraction s'en trouve réduit et le moteur va surchauffer.
9. Ne pas utiliser si la corde ou la prise sont endommagées.
10. Le cordon d'alimentation ne doit pas être tordu ni pincé.
11. Ne pas tirer ou porter l'appareil par le câble, ne pas utiliser le câble comme une poignée, ne pas fermer une porte dessus, ou faire passer le câble dans des bords ou des coins saillants. Ne faites pas rouler l'aspirateur pas-dessus le câble. Éloigner le câble des sources de chaleur.
12. Ne pas tirer sur le câble pour débrancher la prise. Saisir et débrancher la prise, pas le câble. Arrêter l'aspirateur avant de le débrancher.
13. Ne pas manipuler le câble, la prise, l'interrupteur pour l'aspirateur avec les mains mouillées.
14. Ne pas brancher sur une prise électrique dont la puissance en Volts n'est pas adaptée.
15. Ne pas utiliser de rallonge électrique avec cet aspirateur.
16. N'introduire aucun objet dans les orifices. Ne pas utiliser si l'un des orifices est bouché; dégager toute poussière, peluches, cheveux et tout ce qui puisse réduire le flux d'air
17. Éloigner cheveux, vêtements, doigts, et toutes parties du corps des orifices ainsi que des parties amovibles.
18. Être extrêmement attentif lors du nettoyage d'escaliers.
19. Ne pas aspirer de particules inflammables ou combustibles, ou toute autre matière incandescente ou fumante, comme les cigarettes, les allumettes ou le contenu d'un cendrier encore chaud.
20. Ne pas utiliser sans un sac à poussière correctement positionné.
21. Les étincelles à l'intérieur du moteur peuvent enflammer les vapeurs d'un produit ou d'une poussière inflammables. Pour réduire ce risque de feu ou d'explosion, ne pas utiliser à proximité d'un liquide combustible, d'une source de gaz ou de poussières, d'une réserve de carburant (gazole, et autres carburants); liquide fluorescents, produits de nettoyage, peintures et dérivés, gaz naturel.
22. Pour éviter tout risque d'inhalation de vapeurs toxiques ne pas utiliser l'aspirateur à proximité de produits toxiques ou inconnus.
23. Éloigner les enfants et les personnes non-autorisées de l'appareil lorsqu'il est en marche.
24. Cet appareil n'est pas étudié pour être utilisé par des personnes à mobilité réduite ou déficience mentale, ou manquant d'expérience ou de formation.
25. Ne pas tenter de réparer l'aspirateur vous-même. Toute intervention réalisée par une autre personne que les techniciens des centres techniques agréés entraînera l'annulation de la garantie.
26. Stocker l'aspirateur à l'intérieur dans une pièce fraîche et sèche.

### STOCKAGE

Stocker l'aspirateur à l'intérieur dans une pièce fraîche et sèche.

# CONNECT TO A PROPERLY GROUNDED OUTLET ONLY! See Grounding Instructions

## GROUNDIRG INSTRUCTIONS

This vacuum must be grounded! Grounding is a safety measure to reduce the risk of electrical shock to the operator should the machine malfunction or stop working. Grounding provides the path of least resistance for electric current and will trip the circuit breaker, stopping the flow of electricity.

This unit is equipped with a cord that has an equipment-grounding conductor and grounding plug. The plug must be inserted in an appropriate outlet that is properly installed and grounded in accordance with all local codes and ordinances. Cutting off the ground wire or using a cord that is not equipped with a ground plug will void the warranty on the unit. Powr-Flite will accept NO liability associated with the unit.

**⚠ WARNING!** Improper connection of the equipment-grounding conductor can result in a risk of electric shock. Check with a qualified electrician or service person if you are in doubt as to whether the outlet is properly grounded. Do not modify the plug provided with the appliance. If it will not fit the outlet, have a proper outlet installed by a qualified electrician.

The vacuums are for use on a nominal 120-volt circuit, and have a grounded plug that looks like the plug illustrated in Figure A. A temporary adapter that looks like the adapter illustrated in Figure B and C may be used to connect this plug to a 2-pole receptacle as show in Figure B if a properly grounded outlet is not available. The temporary adapter should be used only until a properly grounded outlet (Figure A) can be installed by a qualified electrician. The green colored rigid ear, lug, or the like, extending for the adapter must be connected to a permanent ground such as a properly grounded outlet box cover. Whenever the adapter is used, it must be held in place by a metal screw.

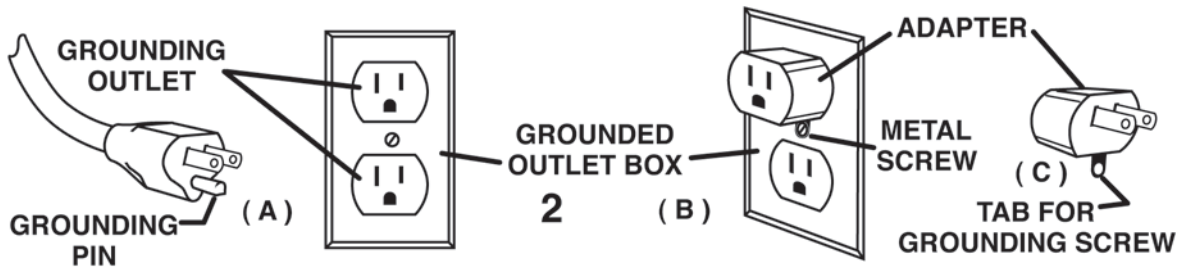

Note: In Canada, the use of a temporary adapter is not permitted by the Canadian Electrical Code.

**⚠ WARNING!** The replacement or repair of damaged wiring should only be performed by a qualified electrician or service engineer from the manufacturer or authorized service center.

# OPERATING INSTRUCTIONS

## IMPORTANT! PERFORM PROPER INSTALLATION OF HEPA BAGS AND CORD IN COMFORT PRO BACKPACK VACUUMS.

Please read the following instructions carefully. They will help to get the best performance from this professional commercial vacuum cleaner and to maintain it in optimum condition. Always make sure the main power of the vacuum is off and the unit is not plugged in when doing any maintenance on the vacuum.

### Preparing To Vacuum

1. Remove vacuum hose from top of unit. (Fig. 1)
  2. Release the two latches and lift off lid. (Fig. 2)
  3. Ensure Micro Cloth bag is fully seated on Comfort Pro tank housing. (Fig. 3)
  4. Fold the bottom 2" of the HEPA bag up and hold into place. (Fig. 4)
  5. Insert HEPA bag inside of micro cloth bag. (Fig.5)
  6. Squeeze bag just below the cardboard collar and drop onto rubber gasket. (Fig. 6)
  7. Ensure that white bag is not protruding under cardboard collar. (Fig. 7)
  8. NOTE: Cardboard must be properly seated inside gasket groove. Cardboard will be flush with gasket. (Fig. 8)
  9. Replace lid, lock down the two latches and install hose. (Fig. 9).
  10. Ensure the extension cord is wrapped around the cord retainer on the harness with 6 inches of cord from the retainer to the end of the plug. (Fig. 10)
- ! WARNING!** Always use the cord retainer. There is a risk of electrical shock/damage to the backpack vacuum if cord retainer is not used. (Fig. 10)
11. Then plug the extension cord to the plug receptacle.
  12. Store the power cord on the cord hook located on the harness after each use. (Fig. 11)



1.



2.



3.



4.



5.



6.



7.



8.



9.

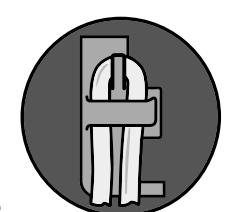

10.

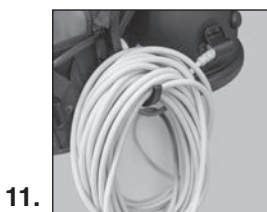

11.

**! WARNING!** Always unplug machine before cleaning, or making any adjustments or repairs.

The backpack vacuum has four levels of filtration: the paper vacuum bag, a micro cloth filter, a pre-motor filter and an exhaust filter. These bags and filters capture fine dust particles and protect the motor from dirt. It is important to replace the paper bag when it is no more than 1/2 full and to clean the filters on a regular schedule and replace as necessary.

### Paper Vacuum Bag

1. Remove paper bag. Insert a new paper bag into the cloth bag, making sure the cardboard disk is centered on the flexible sealing ring. When you replace the lid, the short nozzle in the center of the lid will be closed over the central hole of the cardboard disk of the paper vacuum bag providing a seal. (Fig. A)

2. Replace the lid. Fasten latches and replace hose. (Figs. C-D)

### Micro Cloth Filter

After each use, the cloth filter bag should be inspected.

3. Remove the micro cloth bag, clean and replace. (Fig. B)

4. Replace paper vacuum bag and lid. Fasten latches and insert hose. (Figs. C-D)

### Pre-Motor Filter

The pre-motor filter is located under the micro cloth filter. Inspect after each use. The filter can be washed using cold water and no detergent. Lay flat to dry. Replace every 6 months.

5. Remove the lid, the paper vacuum bag, and the cloth bag to expose the pre-motor filter.

6. Remove the foam pre-motor filter from the dust compartment, clean and replace. If filter is extremely dirty, rinse out and air dry before replacing back into vacuum. (Fig. E)

7. Reinstall the cloth bag, the paper vacuum bag and replace the lid, fasten latches and insert the hose. (Figs. C-D)

### Exhaust Filter

The exhaust filter is an easy-access washable, reusable post-motor filter located on the bottom of the vacuum. For average use of the vacuum, remove and clean the exhaust motor filter every 3 months. The filter can be rinsed using cold water and no detergent. Lay flat to dry. Replace once a year.

8. Remove the foam post motor filter, clean and replace.

9. Reinstall the filter at the bottom of the vacuum. (Fig. F)





## Wearing the Backpack Vacuum

The backpack is designed to balance the weight of the vacuum on the hips, not the shoulders.

1. Adjust the Vari-Quick height adjuster to your back length.
2. Loosen all of the straps and place the vacuum on your back.

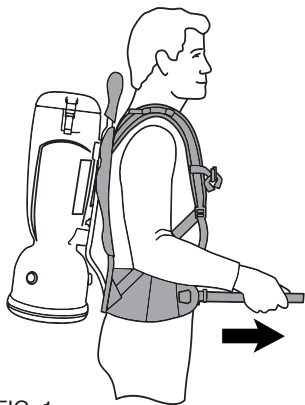

FIG. 1

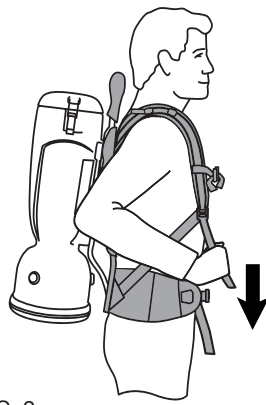

FIG. 2

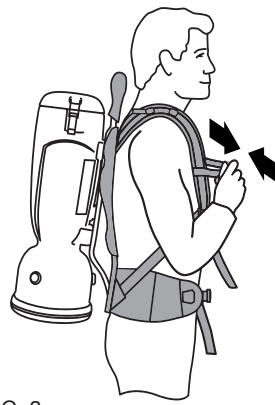

FIG. 3

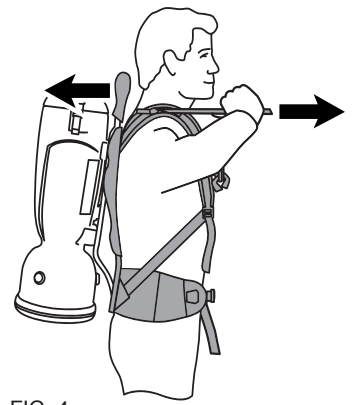

FIG. 4

3. Place the hip belt over your hip and connect the buckle. Your hip bones should be centered between the top and bottom of the belt. Pull the straps forward to tighten the hip belt. (Fig. 1)

4. Pull down the shoulder straps to tighten the backpack on your shoulders. (Fig. 2) Do not tighten too tight. The main weight of the vacuum should be on the hip belt. The anchor points of the shoulder straps should ideally be between the shoulder blades. Adjust the Vari-Quick height adjuster if necessary to properly place the vacuum to your back length.

5. Adjust the sternum strap on a comfortable part of your chest and close the strap. (Fig. 3)

6. Loosen or tighten the stabilizer straps as needed, to fit your back. (Fig. 4)

7. Do final adjustments on the shoulder and stabilizer straps as needed to balance the weight of the vacuum on the hips.

## Active Cooling (Premium Model)

To turn Active Cooling on, raise silver metal bar. (Fig. 5)

Warm air will be pulled into machine and circulate cooler air through mesh on Deuter harness.

Active Cooling can be turned off by lowering silver metal bar. (Fig. 6)

Active Cooling can stay open all the time.



FIG. 5

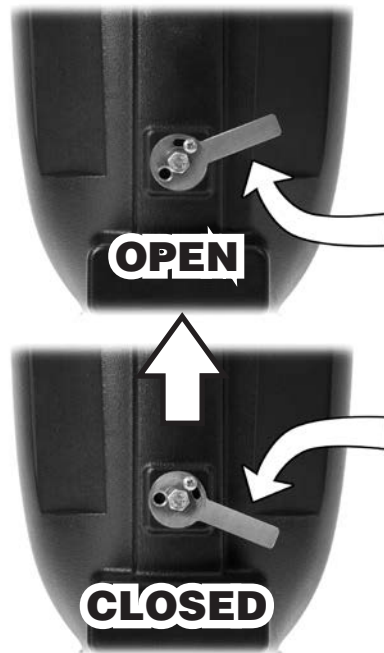

FIG. 6

## MAINTENANCE

Routine maintenance can significantly increase the life of your backpack vacuum. The applications and amount of use varies, so the recommendations listed below are for average-to-high volume use. Constant operation may require additional maintenance.

### Before Each Use

1. Inspect power cord for fraying, cuts or damage; do not use if damaged.
2. Verify that paper vacuum bag is installed.
3. Place the hip belt over your hip and connect the buckle. Your hip bones should be centered between the top and bottom of the belt. Pull the straps forward to tighten the hip belt.
4. Pull down the shoulder straps to tighten the backpack on your shoulders. Do not tighten too tight. The main weight of the vacuum should be on the hip belt. The anchor points of the shoulder straps should ideally be between the shoulder blades. Adjust the Vari-Quick height adjuster if necessary to properly place the vacuum to your back length.
5. Adjust the sternum strap on a comfortable part of your chest and close the strap.
6. Loosen or tighten the stabilizer straps as needed, to fit your back.
7. Do final adjustments on the shoulder and stabilizer straps as needed to balance the weight of the vacuum on the hips.

### After Each Use

1. Unplug cord from wall outlet by pulling on the plug - not the cord.
2. Lay plug on ground.
3. Start at machine and loosely wrap (loop) power cord.
4. Secure the end of the power cord to itself using latch on the plug of the power cord.
5. Hang cord on cord hook.

### Periodic Maintenance

1. Inspect all electrical connections.
2. Check the power cord for any breaks, fraying, separations, or cuts.
3. Make sure the ground pin or grounding prong is intact.



## TROUBLE SHOOTING

If the vacuum will not turn on:

1. Make sure the power cord is firmly connected to the unit and is in good condition.
2. Check sure the power cord is firmly seated in the wall outlet.
3. Check to see if the building circuit breaker is tripped. If circuit is overloaded, move the unit to another circuit.

The backpack vacuum has been fitted with a thermal overload switch to protect the motor against damage should the airflow be blocked for extended periods. This may occur if the vacuum bag is overfull, the micro cloth bag is clogged, or if the vacuum hose or exhaust is blocked. The vacuum motor will stop before it can get too hot. If this happens, empty and thoroughly clean the vacuum bag and filters, or free any blockage and ensure that adequate airflow is restored. After the motor has cooled to a safe operating temperature, locate the thermal reset switch on the bottom of the unit, under the post motor filter and push it back in. There will be a slight audible click. Now the motor will restart.



# SPECIFICATIONS



6 quart model



10 quart model

**Specifications and parts are subject to change without notice.  
Please refer to [www.Powr-Flite.com](http://www.Powr-Flite.com) for the latest schematic drawing and parts list.**

## PRODUCT SPECIFICATIONS

MODEL	COMFORT PRO 6	COMFORT PRO 10	COMFORT PRO 6 PREMIUM	COMFORT PRO 10 PREMIUM
ITEM#	BP6S	BP10S	BP6P	BP10P
TOOL KIT*	Standard	Standard	Hands-Free	Hands-Free
BODY	High Density Polyethylene	High Density Polyethylene	High Density Polyethylene	High Density Polyethylene
DIMENSIONS (L X W X H)	10 in x 12.5 in x 26.5 in 25.4 cm x 31.8 cm x 67.3 cm	13" x 11.5" x 26.5" 33 cm x 29.2 cm x 67.3 cm	10 in x 12.5 in x 26.5 in 25.4 cm x 31.8 cm x 67.3 cm	13" x 11.5" x 26.5" 33 cm x 29.2 cm x 67.3 cm
MACHINE WEIGHT (LBS. / KG)	8.62 lbs. / 3.22 kg	9.62 lbs. / 4.3636 kg	8.75 lbs. / 3.9689kg	9.75 lbs. / 4.4225 kg
HARNESS WEIGHT (LBS. / KG)	3.2 lbs. / 1.45 kg	3.2 lbs. / 1.45 kg	3.2 lbs. / 1.45 kg	3.2 lbs. / 1.45 kg
CORD LENGTH / TYPE	50 ft. / 15 m, direct plug	50 ft. / 15 m, direct plug	50 ft. / 15 m, direct plug	50 ft. / 15 m, direct plug
CAPACITY (QUARTS / LITERS)	6 qt. / 5.69 l	10 qt. / 9.46 l	6 qt. / 5.69 l	10 qt. / 9.46 l
FILTRATION	5 stage HEPA	5 stage HEPA	5 stage HEPA	5 stage HEPA
WATERLIFT	110 in. / 279 cm	110 in. / 279 cm	110 in. / 279 cm	110 in. / 279 cm
CFM /CMM	130 cfm / 3.68 cmm	130 cfm / 3.68 cmm	130 cfm / 3.68 cmm	130 cfm / 3.68 cmm
CLEANING PRODUCTIVITY	7,407 sq. feet per hour 688 sq. meters per hour	7,407 sq. feet per hour 688 sq. meters per hour	7,407 sq. feet per hour 688 sq. meters per hour	7,407 sq. feet per hour 688 sq. meters per hour
SOUND LEVEL	62 dBa	62 dBa	62 dBa	62 dBa
VACUUM MOTOR	1200 W / 10 Amp	1200 W / 10 Amp	1200 W / 10 Amp	1200 W / 10 Amp
POWER	120V / 60Hz	120V / 60Hz	120V / 60Hz	120V / 60Hz
APPROVALS	CRI Gold Level Approved	CRI Gold Level Approved	CRI Gold Level Approved	CRI Gold Level Approved
230V AVAILABLE	Yes	Yes	Yes	Yes

# TOOL KITS

## Standard Tool Kit

Fits: BP6S - BP10S

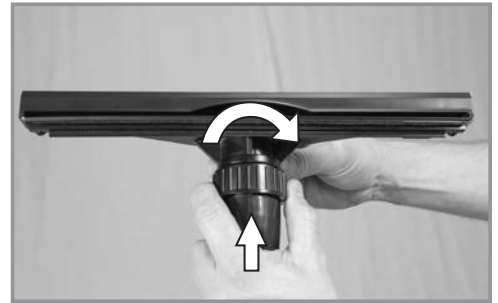
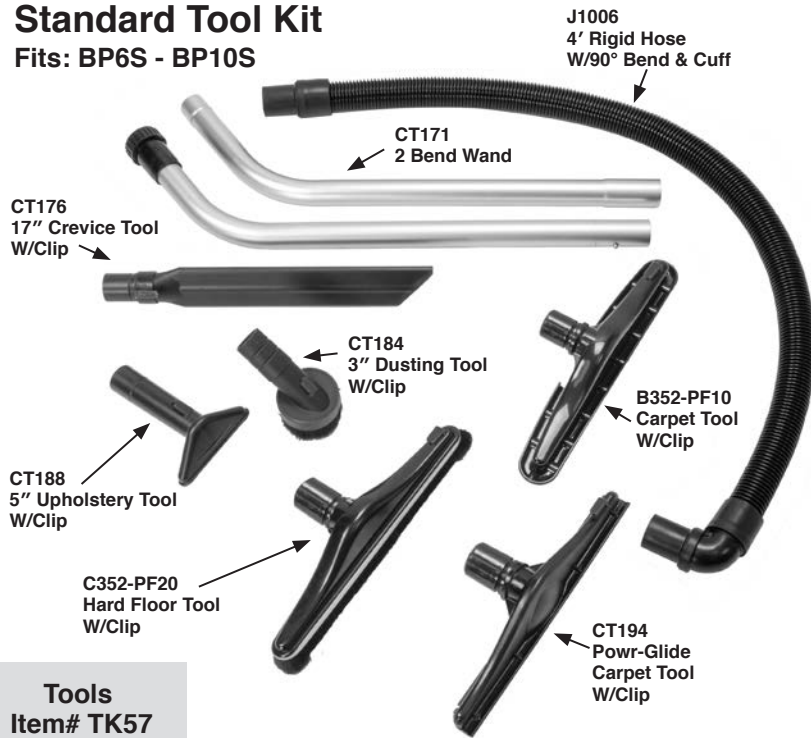

Install the floor tool to the end of the wand. Align the brass ring with the groove on the floor tool to ensure a secure fit.

## Premium Tool Kit

Fits: BP6P - BP10P



To properly attach one-bend adapter (#J1007) to the one-bend telescopic wand (#CT170):

Install the adapter on the wand with the line pointing to the center of the notches on the wand.

Install floor tool onto adapter and tighten plastic nut to secure.

# TOOLS SCHEMATICS AND PARTS LIST

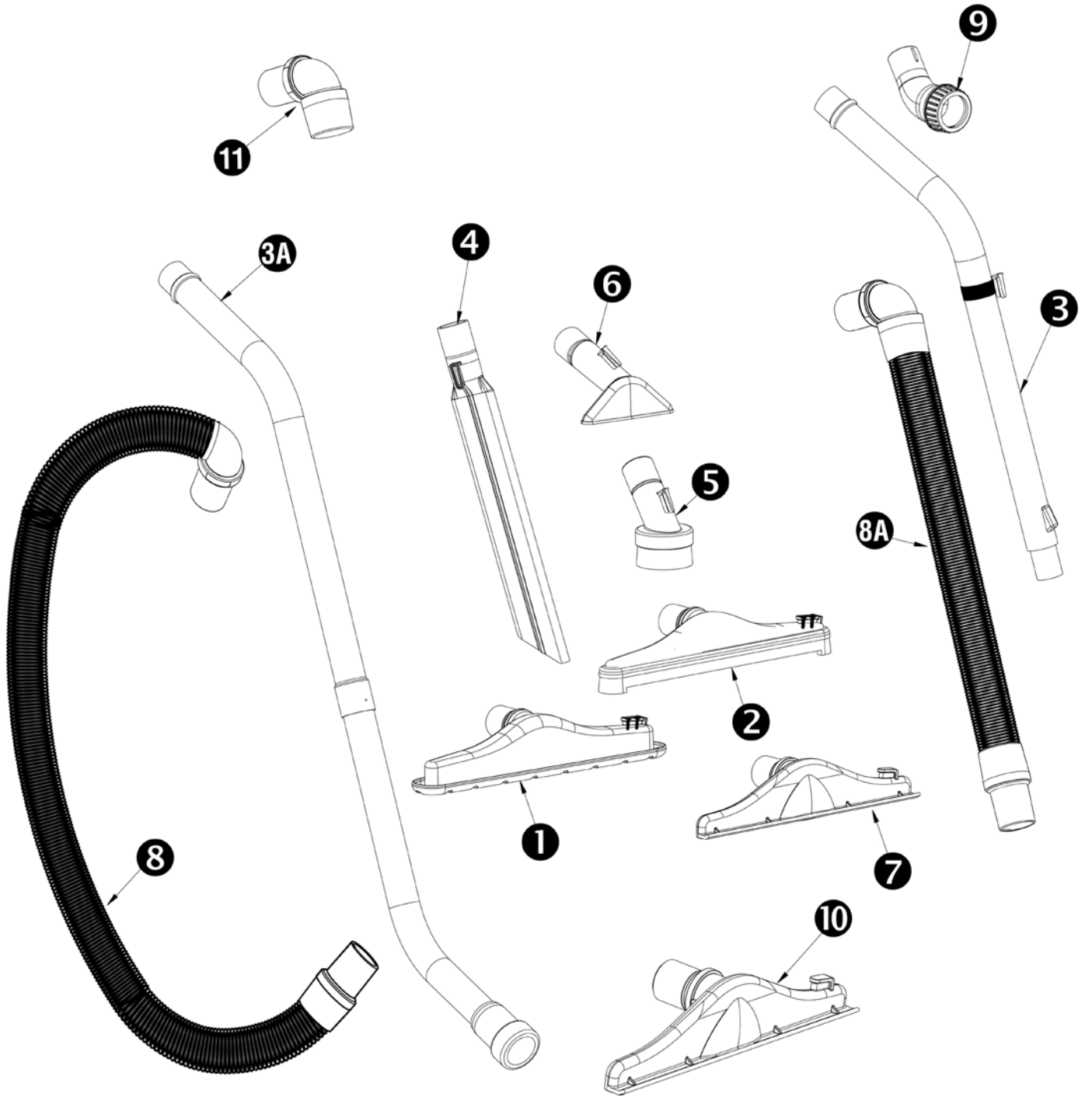

<b>STANDARD TOOL KIT - FITS BP6S - BP10S</b>			
<b>ITEM</b>	<b>DESCRIPTION</b>	<b>PART NO.</b>	<b>QTY</b>
1	CARPET TOOL W/CLIP	B352-PF10	1
2	HARD FLOOR TOOL W/CLIP	C352-PF20	1
3A	DOUBLE BEND WAND	CT171	1
4	17" CREVICE TOOL W/CLIP	CT176	1
5	3" DUSTING TOOL W/CLIP	CT184	1
6	5" UPHOLSTERY TOOL W/CLIP	CT188	1
7	POWR-GLIDE CARPET TOOL W/CLIP	CT194	1
8	4' CRUSH PROOF HOSE W/90° CUFF	J1006	1
10	POWR-GLIDE CARPET TOOL BODY W/CLIP	CT190	1
11	90 DEGREE SWIVEL CUFF	J1004	1

<b>PREMIUM TOOL KIT - FITS BP6P - BP10P</b>			
<b>ITEM</b>	<b>DESCRIPTION</b>	<b>PART NO.</b>	<b>QTY</b>
1	CARPET TOOL W/CLIP	B352-PF10	1
2	HARD FLOOR TOOL W/CLIP	C352-PF20	1
3	SINGLE BEND TELESCOPING WAND W/CLIP	CT170	1
4	17" CREVICE TOOL W/CLIP	CT176	1
5	3" DUSTING TOOL W/CLIP	CT184	1
6	5" UPHOLSTERY TOOL W/CLIP	CT188	1
7	POWR-GLIDE CARPET TOOL W/CLIP	CT194	1
8A	2' - 6' STRETCH HOSE W/90° CUFF	J1005	1
9	ONE BEND WAND ADAPTOR	J1007	1
10	POWR-GLIDE CARPET TOOL BODY W/CLIP	CT190	1
11	90 DEGREE SWIVEL CUFF	J1004	1

# SCHEMATIC – BP6S - BP10S

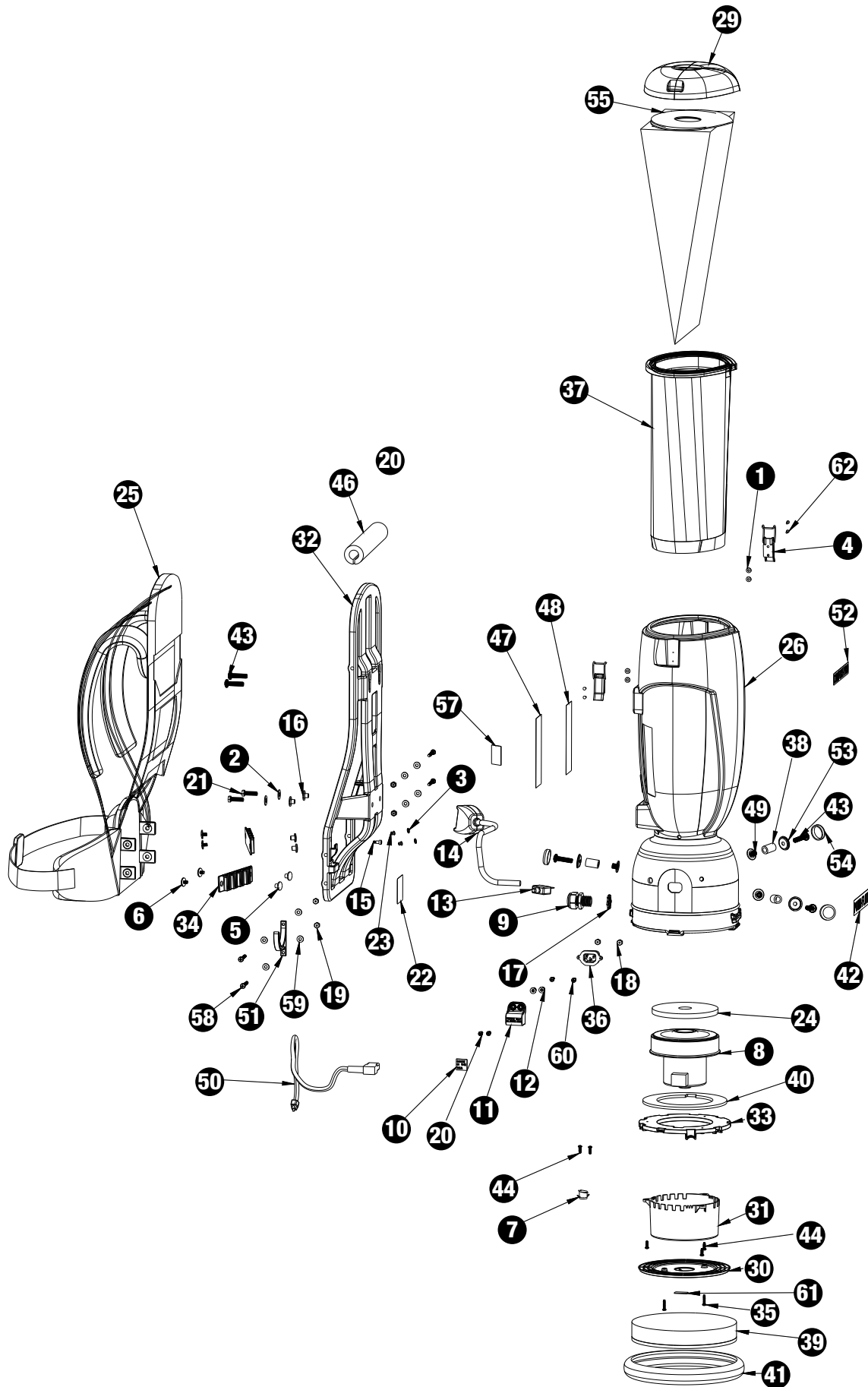



# PARTS LIST - BP6S - BP10S

ITEM	DESCRIPTION	PART NO.
1	#6 FLAT WASHER ZP	01575
2	HARNESS MOUNTING WASHER	02568
3	WASHER #10 INT TOOTH, LOCK	7CY001
4	LID LATCH	A352-3300
5	FEMALE RIVOT FOR BELT PANEL	A352-9401
6	BELT PANEL MOUNTING SCREW	A352-9402
7	THERMAL RESET SWITCH	B333-0400B
8	5.1" VACUUM MOTOR	B395-2000
9	STRAIN RELIEF	PD8
10	SMALL MADE IN THE USA LABEL	X1004
11	PLUG COVER, COMFORT PRO	X1042
12	8-32 POST MOLD INSERT	X1075
13	12A CIRCUIT BREAKER	X1141
14	BACKPACK SWITCH ASSEMBLY	X1151
15	PAN HEAD SHOULDERED PHILLIPS M4X7 BLACK	X1257
16	NEOPRENE RUBBER NUT	X1466
17	NUT, LOCK, 1/2" STEEL CONDUIT	X8008N
18	6-32 NYLON LOCK NUT	X8257
19	10-24 NYLON LOCK NUT ZP	X8271
20	SCREW 8-32 X 1/2 PAN	X8278
21	BOLT 1/4-20 X 1" HEX	X8282
22	LABEL, SERIAL NUMBER, PLAIN	X8459
23	MOUNTING RIVOT	X8946
24	GASKET 3/8" DONUT MOTOR SEAL	X9079
25	DEUTER HARNESS	X9658
26	HOUSING 10QT COMFORT VAC WITH FILTER	X9663-F
27	HOUSING 6QT COMFORT VAC WITH FILTER	X9664-F
28	10 QUART LID	X9665
29	6 QUART LID	X9666
30	EXHAUST FILTER PLATE	X9667
31	MOTOR SHIELD	X9669
32	HARNESS FRAME	X9670
33	MOTOR MOUNTING BRACKET	X9671
34	BELT CLIP PANEL	X9672
35	8-18 3/4 LONG HI LO SCREW	X9676
36	PLUG RECEPTICLE	X9677
37	6 QUART CLOTH BAG	X9679
38	RUBBER MOTOR MOUNT	X9681
39	EXHAUST FILTER	X9682
40	MOTOR PLATE GASKET	X9684
41	HOUSING BUMPER	X9685
42	POWR-FLITE LABEL	X9687
43	MOTOR MOUNTING BOLT	X9688
44	8-18 HI-LO SCREW	X9690
45	10 QUART SMS BAG	X9692
46	9" LONG PIPE INSULATION	X9693
47	WARNING LABEL	X9697
48	HARNESS LABEL	X9698
49	MOTOR MOUNTING WELDNUT	X9713

ITEM	DESCRIPTION	PART NO.
50	18 GAGE 50' YELLOW EXTENSION CORD	X9714
51	CORD HOOK	X9718
52	COMFORT PRO LABEL	X9729
53	SCREW CAP BASE	X9733
54	SCREW CAP	X9734
55	6 QUART HEPA BAG	X9739
56	10 QUART HEPA BAG	X9740
57	CRI GOLD LABEL	X9742
58	10-24 X 1.75" PHIL PAN HEAD SCREW BLACK	X9746
59	#10 USS FLAT WASHER BLACK	X9747
60	6-32 X 5/8 PHIL PAN SCREW BLACK	X9748
61	MOTOR RESET LABEL	X9755
62	RIVET	X9758

# SCHEMATIC – BP6P - BP10P

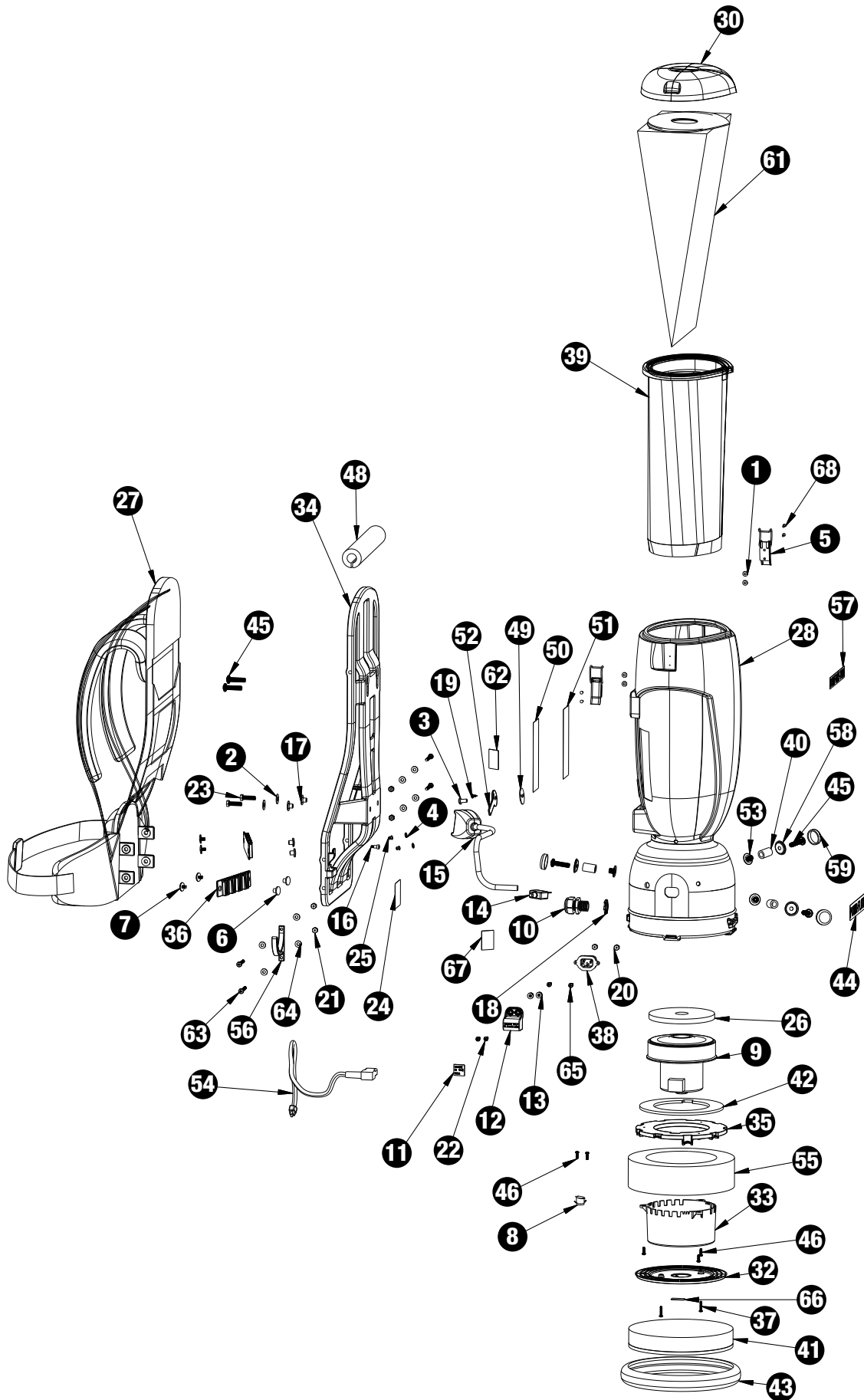

# PARTS LIST - BP6P - BP10P

ITEM	DESCRIPTION	PART NO.
1	#6 FLAT WASHER ZP	01575
2	HARNESS MOUNTING WASHER	02568
3	SCREW, 1/4-20X1/2 PHIL PAN BLACK 18-8 SS	7BS003-BLK
4	WASHER #10 INT TOOTH, LOCK	7CY001
5	LID LATCH	A352-3300
6	FEMALE RIVOT FOR BELT PANEL	A352-9401
7	BELT PANEL MOUNTING SCREW	A352-9402
8	THERMAL RESET SWITCH	B333-0400B
9	5.1" VACUUM MOTOR	B395-2000
10	STRAIN RELIEF	PD8
11	SMALL MADE IN THE USA LABEL	X1004
12	PLUG COVER, COMFORT PRO	X1042
13	8-32 POST MOLD INSERT	X1075
14	12A CIRCUIT BREAKER	X1141
15	BACKPACK SWITCH ASSEMBLY	X1151
16	PAN HEAD SHOULDERED PHILLIPS M4X7 BLACK	X1257
17	NEOPRENE RUBBER NUT	X1466
18	NUT, LOCK, 1/2" STEEL CONDUIT	X8008N
19	SCREW #8 X 3/8 PHIL PAN TYPE B	X8201
20	6-32 NYLON LOCK NUT	X8257
21	10-24 NYLON LOCK NUT ZP	X8271
22	SCREW 8-32 X 1/2 PAN	X8278
23	BOLT 1/4-20 X 1" HEX	X8282
24	LABEL, SERIAL NUMBER, PLAIN	X8459
25	MOUNTING RIVOT	X8946
26	GASKET 3/8" DONUT MOTOR SEAL	X9079
27	DEUTER HARNESS	X9658
28	HOUSING 10QT COMFORT VAC WITH FILTER	X9663-F
29	HOUSING 6QT COMFORT VAC WITH FILTER	X9664-F
30	10 QUART LID	X9665
31	6 QUART LID	X9666
32	EXHAUST FILTER PLATE	X9667
33	MOTOR SHIELD	X9669
34	HARNESS FRAME	X9670
35	MOTOR MOUNTING BRACKET	X9671
36	BELT CLIP PANEL	X9672
37	8-18 3/4 LONG HI LO SCREW	X9676
38	PLUG RECEPTICLE	X9677
39	6 QUART CLOTH BAG	X9679
40	RUBBER MOTOR MOUNT	X9681
41	EXHAUST FILTER	X9682
42	MOTOR PLATE GASKET	X9684
43	HOUSING BUMPER	X9685
44	POWR-FLITE LABEL	X9687
45	MOTOR MOUNTING BOLT	X9688

ITEM	DESCRIPTION	PART NO.
46	8-18 HI-LO SCREW	X9690
47	10 QUART SMS BAG	X9692
48	9" LONG PIPE INSULATION	X9693
49	AC GASKET COMFORT PRO	X9695
50	WARNING LABEL	X9697
51	HARNESS LABEL	X9698
52	AHE LEVER	X9699
53	MOTOR MOUNTING WELDNUT	X9713
54	18 GAGE 50' YELLOW EXTENSION CORD	X9714
55	SOUND DAMPING FOAM RING	X9717
56	CORD HOOK	X9718
57	COMFORT PRO LABEL	X9729
58	SCREW CAP BASE	X9733
59	SCREW CAP	X9734
60	6 QUART HEPA BAG	X9739
61	10 QUART HEPA BAG	X9740
62	CRI GOLD LABEL	X9742
63	10-24 X 1.75" PHIL PAN HEAD SCREW BLACK	X9746
64	#10 USS FLAT WASHER BLACK	X9747
65	6-32 X 5/8 PHIL PAN SCREW BLACK	X9748
66	MOTOR RESET LABEL	X9755
67	AC LEVER LABEL	X9756
68	RIVET	X9758

## POWR-FLITE LIMITED WARRANTY

Powr-Flite will repair or exchange parts for your vacuum in the event of a manufacturing defect as follows:

**PARTS:** New or comparable rebuilt parts, for one year after original purchase. Lifetime warranty on molded body.

**LABOR:** Labor warranty for one year. Carry-in service can be obtained during the warranty period by taking your vacuum to an Authorized Powr-Flite Warranty Service Center.

**IMPORTANT WARRANTY CONDITIONS:** A purchase receipt or other proof of date of original consumer purchase also will be required before warranty service is rendered.

This warranty covers normal use and does not cover damage which occurs in shipment or failure resulting from alteration, accident, misuse, abuse, neglect, or improper maintenance.

**STATEMENT:** This warranty is not transferable and extends only to the original purchaser when a new Powr-Flite vacuum is purchased from an Authorized Powr-Flite Dealer. This warranty gives you specific legal rights, and you may have other rights that vary from state to state.

# ***Powr-Flite***<sup>®</sup>

A Tacony Company

3101 Wichita Court • Ft. Worth, TX 76140-1755  
1-800-880-2913 • Fax: 1-817-551-0719 • [www.Powr-Flite.com](http://www.Powr-Flite.com)