

PONY | JORGENSEN®

Clamps without compromise.

Since 1903



PRODUCT CATALOG

METICULOUS ATTENTION TO EVERY DETAIL

Since 1903, Pony Jorgensen has provided craftspeople from all walks of life with clamps that are crafted differently. And to this day, making high-quality clamps is still our driving passion. First, we source materials that meet our exacting standards. Our bar clamps are made with high-carbon rust-resistant steel, and only the finest seasoned, straight-grain North American maple wood makes it into our iconic Jorgensen handscrews.

Then, we manufacture our clamps under strict guidelines and inspect each one to guarantee consistency and performance. Pony Jorgensen clamps are crafted with only the highest-quality materials because our mission is simple – to serve customers by providing the best products with the most trusted reputation in the industry.





BAR CLAMPS

Pony Jorgensen offers a wide range of bar clamps ideal for DIYers, hobbyists, woodworkers, carpenters, cabinetmakers, metalworkers, and everyone in between. Made with high-quality aluminum and steel to last as long as the pieces you craft.



Jorgensen steel bar clamp

Jorgensen steel bar clamps are seriously strong. Cast-iron stationary and sliding heads with an orange-powder-coated finish are merged with a high-carbon rust-resistant steel bar that packs a whopping 85,000 pounds per square inch of tensile strength. The fast-acting sliding head is acme threaded to accommodate a cold-drawn steel screw with a large easy-grip handle and swivel pad. And our original multiple-disc-clutch design allows the sliding head to hold securely at any point along the bar. Available in a wide variety of sizes and clamping forces for light-duty, medium-duty, and heavy-duty applications.



Carbon Steel



Cold-Drawn Screw



Multiple-Disc Clutch

HEAVY DUTY

Product Number	Max Opening	Reach	Clamping Force	Bar
3706-HD	6 in.	3 in.	1,000 lb.	1 x 5/16 in.
3712-HD	12 in.	3 in.	1,000 lb.	1 x 5/16 in.
3718-HD	18 in.	3 in.	1,000 lb.	1 x 5/16 in.
3724-HD	24 in.	3 in.	1,000 lb.	1 x 5/16 in.
3730-HD	30 in.	3 in.	1,000 lb.	1 x 5/16 in.
3736-HD	36 in.	3 in.	1,000 lb.	1 x 5/16 in.

MEDIUM DUTY

Product Number	Max Opening	Reach	Clamping Force	Bar
3706	6 in.	2 1/2 in.	600 lb.	3/4 x 1/4 in.
3712	12 in.	2 1/2 in.	600 lb.	3/4 x 1/4 in.
3718	18 in.	2 1/2 in.	600 lb.	3/4 x 1/4 in.
3724	24 in.	2 1/2 in.	600 lb.	3/4 x 1/4 in.
3730	30 in.	2 1/2 in.	600 lb.	3/4 x 1/4 in.
3736	36 in.	2 1/2 in.	600 lb.	3/4 x 1/4 in.

LIGHT DUTY

Product Number	Max Opening	Reach	Clamping Force	Bar
3704-LD	4 in.	2 in.	300 lb.	5/8 x 3/16 in.
3706-LD	6 in.	2 in.	300 lb.	5/8 x 3/16 in.
3708-LD	8 in.	2 in.	300 lb.	5/8 x 3/16 in.
3712-LD	12 in.	2 in.	300 lb.	5/8 x 3/16 in.

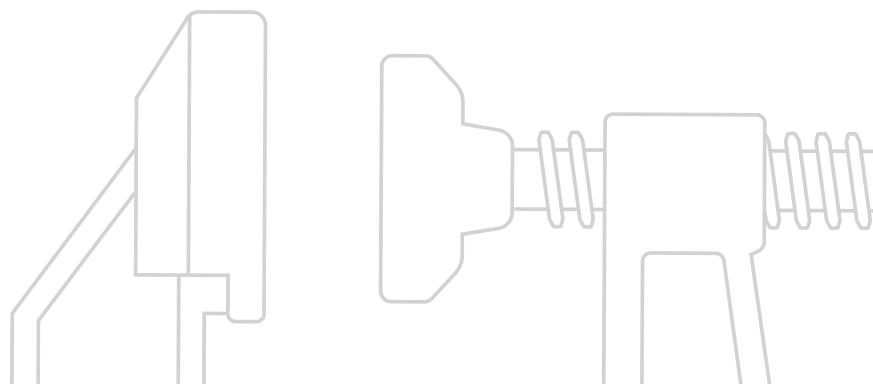

Jorgensen deep-reach throat bar clamp

When your project calls for a deeper hold, reach for Jorgensen deep throat steel bar clamps. They contain all the same high-quality materials as our traditional steel bar clamps but with five-inch, seven-inch, and nine-inch reaches. And welders take note: the copper-plated screws, handles, and swivels help protect against weld spatter in welding jobs.

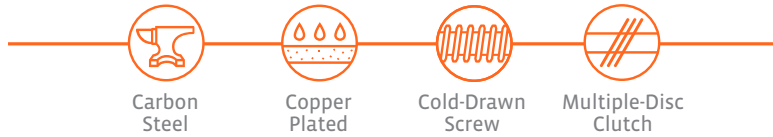

FIVE INCH

Product Number	Max Opening	Reach	Clamping Force	Handle	Bar
4512	12 in.	5 in.	1,200 lb.	Soft grip	1 3/8 x 5/16 in.
4524	24 in.	5 in.	1,200 lb.	Soft grip	1 3/8 x 5/16 in.
4536	36 in.	5 in.	1,200 lb.	Soft grip	1 3/8 x 5/16 in.
4548	48 in.	5 in.	1,200 lb.	Soft grip	1 3/8 x 5/16 in.
4560	60 in.	5 in.	1,200 lb.	Soft grip	1 3/8 x 5/16 in.

SEVEN INCH

Product Number	Max Opening	Reach	Clamping Force	Handle	Bar
4712	12 in.	7 in.	1,200 lb.	Soft grip	1 1/2 x 3/8 in.
4724	24 in.	7 in.	1,200 lb.	Soft grip	1 1/2 x 3/8 in.
4736	36 in.	7 in.	1,200 lb.	Soft grip	1 1/2 x 3/8 in.
4748	48 in.	7 in.	1,200 lb.	Soft grip	1 1/2 x 3/8 in.
4760	60 in.	7 in.	1,200 lb.	Soft grip	1 1/2 x 3/8 in.
4772	72 in.	7 in.	1,200 lb.	Soft grip	1 1/2 x 3/8 in.

NINE INCH

Product Number	Max Opening	Reach	Clamping Force	Handle	Bar
4912	12 in.	9 in.	1,200 lb.	Steel sliding pin	1 1/2 x 3/8 in.
4924	24 in.	9 in.	1,200 lb.	Steel sliding pin	1 1/2 x 3/8 in.
4936	36 in.	9 in.	1,200 lb.	Steel sliding pin	1 1/2 x 3/8 in.
4948	48 in.	9 in.	1,200 lb.	Steel sliding pin	1 1/2 x 3/8 in.
4960	60 in.	9 in.	1,200 lb.	Steel sliding pin	1 1/2 x 3/8 in.
4972	72 in.	9 in.	1,200 lb.	Steel sliding pin	1 1/2 x 3/8 in.

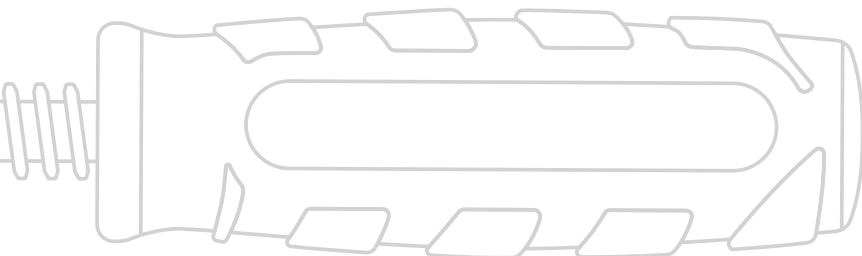



Jorgensen aluminum bar clamp

Jorgensen aluminum bar clamps have an excellent strength-to-weight ratio, making these strong, lightweight bar clamps perfect for both commercial and DIY applications. The bars are crafted from an anodized rust-resistant aluminum, and their rectangular design creates a stable clamping surface for edge-gluing. The tail-stop's trigger spring takes advantage of notches on the bar to lock into place.



Anodized
Aluminum

SPECS

Product Number	Max Opening	Reach	Clamping Force	Handle	Bar
3524	24 in.	1 5/8 in.	1,000 lb.	Sliding pin	1 5/16 x 13/16 in.
3536	36 in.	1 5/8 in.	1,000 lb.	Sliding pin	1 5/16 x 13/16 in.
3548	48 in.	1 5/8 in.	1,000 lb.	Sliding pin	1 5/16 x 13/16 in.
3560	60 in.	1 5/8 in.	1,000 lb.	Sliding pin	1 5/16 x 13/16 in.
3572	72 in.	1 5/8 in.	1,000 lb.	Sliding pin	1 5/16 x 13/16 in.



Jorgensen drop-forged heavy-duty bar clamp

For hobbyists, carpenters, cabinetmakers, woodworkers, metalworkers, and professional tradespeople seeking a bar clamp with superior rust resistance, look no further than the Jorgensen drop-forged bar clamp. The drop-forged steel bar is chrome plated to ward off rust longer, and a heat-treated acme screw provides increased durability.



Drop-Forged
Steel



Chrome
Plated

SPECS

Product Number	Max Opening	Reach	Clamping Force	Handle	Bar
75306	6 in.	3 in.	450 lb.	Steel sliding pin	1/4 x 5/8 in.
75312	12 in.	3 in.	450 lb.	Steel sliding pin	1/4 x 5/8 in.
75318	18 in.	3 in.	450 lb.	Steel sliding pin	1/4 x 5/8 in.
75418	18 in.	4 1/2 in.	1,000 lb.	Steel sliding pin	3/8 x 7/8 in.

Jorgensen E-Z HOLD expandable bar clamp

Unique Jorgensen E-Z HOLD bar clamps allow for rapid and easy clamping and can easily be converted to spreader clamps. The contoured comfort grip and quick-release lever make it simple to get a firm grasp, and our exclusive patented feature lets you join two clamps together to create a clamp with more than double the opening capacity of a single clamp. Deep-reach pads help protect your work.



Patented Feature



Ergonomic Grip



MEDIUM DUTY

Product Number	Max Opening	Reach	Clamping Force	Handle
33406	6 in.	3 3/8 in.	300 lb.	Grip lever
33412	12 in.	3 3/8 in.	300 lb.	Grip lever
33418	18 in.	3 3/8 in.	300 lb.	Grip lever
33424	24 in.	3 3/8 in.	300 lb.	Grip lever
33436	36 in.	3 3/8 in.	300 lb.	Grip lever

LIGHT DUTY

Product Number	Max Opening	Reach	Clamping Force	Handle
33606	6 in.	2 1/2 in.	150 lb.	Grip lever
33612	12 in.	2 1/2 in.	150 lb.	Grip lever

Jorgensen E-Z HOLD hobby bar clamp

Our most affordable E-Z HOLD bar clamps are ideal for hobby and craft projects. They come with all the same features of our medium- and light-duty E-Z HOLD clamps, except for the ability to join two clamps together.



Patented Feature



Ergonomic Grip



SPECS

Product Number	Max Opening	Reach	Clamping Force	Handle
33804	4 in.	1 1/2 in.	50 lb.	Grip lever
33808	8 in.	1 1/2 in.	50 lb.	Grip lever



Jorgensen Cabinet Master 90° parallel jaw bar clamp

The Jorgensen Cabinet Master 90° parallel jaw bar clamp is a cabinetmaker's best friend. Its large jaws distribute clamping pressure over wide areas and stay parallel to ensure square corners and prevent workpieces from bowing or lifting. This makes it the perfect clamp for flat-panel, box, cabinet, frame, and panel-door assemblies – or any project that requires squareness or evenly applied pressure. A built-in clamp stand allows for one-handed use and quicker sliding-head adjustment. Want to use it as a spreader? Just reverse the sliding head.



Steel Bar

SPECS

Product Number	Max Opening	Reach	Clamping Force	Handle	Bar
8012	12 in.	3 7/8 in.	1,500 lb.	Soft grip	1 3/16 x 3/8 in.
8018	18 in.	3 7/8 in.	1,500 lb.	Soft grip	1 3/16 x 3/8 in.
8024	24 in.	3 7/8 in.	1,500 lb.	Soft grip	1 3/16 x 3/8 in.
8030	30 in.	3 7/8 in.	1,500 lb.	Soft grip	1 3/16 x 3/8 in.
8036	36 in.	3 7/8 in.	1,500 lb.	Soft grip	1 3/16 x 3/8 in.
8048	48 in.	3 7/8 in.	1,500 lb.	Soft grip	1 3/16 x 3/8 in.
8060	60 in.	3 7/8 in.	1,500 lb.	Soft grip	1 3/16 x 3/8 in.
8072	72 in.	3 7/8 in.	1,500 lb.	Soft grip	1 3/16 x 3/8 in.



Jorgensen industrial steel I-bar clamp

There's a reason Jorgensen I-bar clamps are our most popular heavy-duty steel bar clamps. The special steel I-bar design is tremendously strong and stiff, and the clamp head is fixed for maximum resilience. A cold-drawn steel screw with smoothly cut acme threads attaches to ductile cast-iron castings to complete the clamp. Depend on this clamp to withstand the rigorous daily demands of school shops, commercial woodworking operations, metalworking factories, welding applications, and serious woodworking applications.



SPECS

Product Number	Max Opening	Reach	Clamping Force	Handle	Bar
7224	24 in.	1 3/4 in.	7,000 lb.	Crank	1 1/2 x 7/16 in.
7230	30 in.	1 3/4 in.	7,000 lb.	Crank	1 1/2 x 7/16 in.
7236	36 in.	1 3/4 in.	7,000 lb.	Crank	1 1/2 x 7/16 in.
7248	48 in.	1 3/4 in.	7,000 lb.	Crank	1 1/2 x 7/16 in.
7260	60 in.	1 3/4 in.	7,000 lb.	Crank	1 1/2 x 7/16 in.
7272	72 in.	1 3/4 in.	7,000 lb.	Crank	1 1/2 x 7/16 in.
7284	84 in.	1 3/4 in.	7,000 lb.	Crank	1 1/2 x 7/16 in.
7296	96 in.	1 3/4 in.	7,000 lb.	Crank	1 1/2 x 7/16 in.

Pony Jorgensen work-protecting bar clamp pads

Our clamp pads eliminate the need for wood blocks by adding soft, durable plastic padding to your clamps that provides a resilient nonstick, nonslip protective cushion when clamping wood, metal, and plastic surfaces. Can be added to many Jorgensen bar clamps.



SPECS

Product Number	Description
7437	Work-protecting bar clamp pads



PIPE CLAMPS

Trust America's most popular and widely used pipe clamp fixture with your next woodworking projects and see why Pony Jorgensen original pipe clamps are the tried and true choice.

Made with our original steel multiple-disc clutch for unmatched versatility on any length pipe.



Classic Pony pipe clamp fixture for 3/4-inch black pipe

The iconic Pony 3/4-inch pipe clamp has become America's most popular and widely used pipe clamp fixture design. Our original steel multiple-disc-clutch design allows a secure hold and instant adjustment at any point along the pipe, without fear of slipping or pipe crushing. Use any length of 3/4-inch galvanized or black pipe, as long as the pipe is seven inches longer than your workpiece. Crafted with strong, durable iron casting. Clamping face is 1 3/4 inches.



Cast Iron



Multiple-Disc Clutch

SPECS

Product Number	Handle	Pipe Used
50	Crank	3/4 in.



Pony pipe clamp fixture for 1/2-inch black pipe

Enjoy the trusted strength, reliability, and features of our original Pony pipe clamp fixtures with any length of 1/2-inch galvanized or black pipe. Ideal for small and light-duty projects. Clamping face is 1 1/2 inches.



Cast Iron



Multiple-Disc Clutch

SPECS

Product Number	Handle	Pipe Used
52	Sliding pin	1/2 in.

Pony professional pipe clamp fixture

The heavy-duty version of our original Pony pipe clamp fixture comes with a longer acme-threaded screw, a wider, taller stance, and a built-in clamp hanger for more-demanding projects, including industrial applications. Clamping face is 1 3/4 inches.



SPECS

Product Number	Handle	Pipe Used
55	Crank	3/4 in.

Pony deep-reach pipe clamp fixture

Our deep-reach pipe clamp fixture features a reach of 2 1/2 inches. Reverse the heads to easily turn it into a spreader clamp. Ideal for use in tight quarters.



SPECS

Product Number	Handle	Pipe Used
56	Wing nut	3/4 in.

Pony pipe clamp pads

Our clamp pads eliminate the need for wood blocks by adding soft, durable plastic padding to your clamps that provides a resilient nonstick, nonslip protective cushion when clamping wood, metal, and plastic surfaces. Recommended for use with pipe clamp fixtures #50 and #52, as well as 3500- and 7200-series bar clamps.

SPECS

Product Number	Description
7456	Pipe/bar clamp pads





C-CLAMPS

Pony Jorgensen carries a wide range of high-quality C-clamps with features like acme-threaded screws and heat-treated steel frames to fit the needs of any woodworker or welder for hobby, light-duty, and heavy-duty applications.



Classic Pony light-duty C-clamp

Discover America's most popular and complete line of light-duty C-clamps. The smoothly cut acme-threaded steel screw is protected with a black-oxide finish for lasting durability. And the clamp casting is made with ductile iron for strength before receiving a powder-coated Pony-orange finish. Available in a wide variety of sizes and clamping forces, all with full-closing screws.



Cast Iron



Zinc Plated

LIGHT DUTY

Product Number	Max Opening	Reach	Clamping Force
1440-C	4 in.	3 in.	1,200 lb.
1450-C	5 in.	3 1/4 in.	1,200 lb.
1460-C	6 in.	3 1/2 in.	1,200 lb.
1480-C	8 in.	4 in.	1,200 lb.

HOBBY

Product Number	Max Opening	Reach	Clamping Force
2610	1 in.	1 in.	400 lb.
2615	1 1/2 in.	1 1/2 in.	400 lb.
2620	2 in.	1 in.	400 lb.
2622	2 1/2 in.	1 3/8 in.	600 lb.
2625	2 1/2 in.	2 1/2 in.	600 lb.
2630	3 in.	2 in.	800 lb.
2640	4 in.	3 in.	800 lb.
2650	5 in.	3 1/4 in.	1,000 lb.
2660	6 in.	3 1/2 in.	1,000 lb.
2680	8 in.	4 in.	1,000 lb.

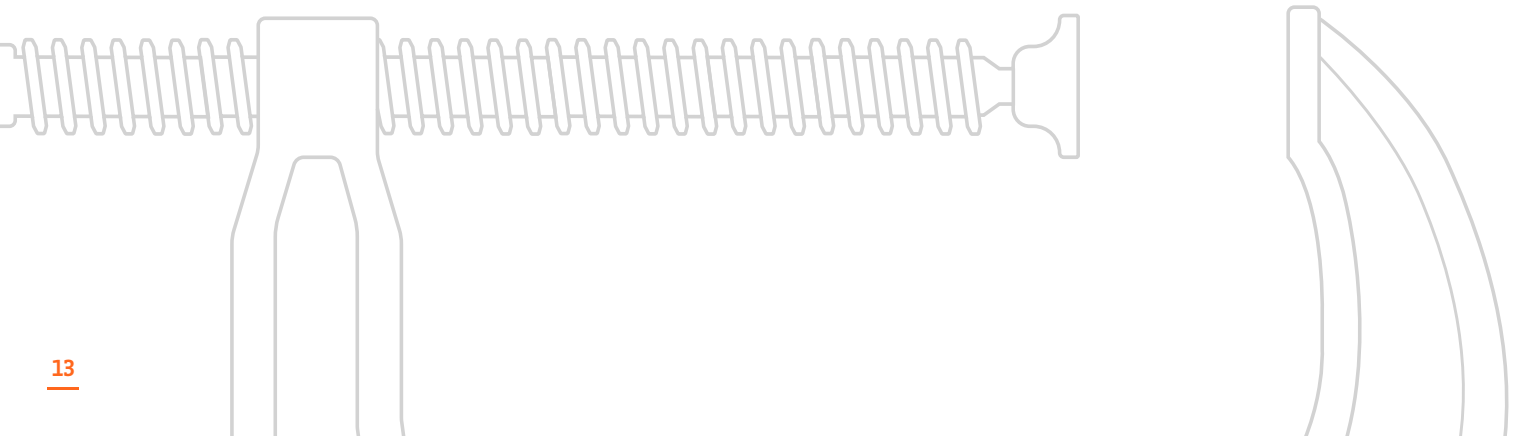

Pony heavy-duty drop-forged C-clamp

The toughest jobs demand a tougher clamp. Our strongest C-clamps are crafted with heat-treated drop-forged carbon steel frames, copper-coated screws, handles, and swivels for heavy-duty industrial service. The anvil is extra large and broached for flatness, and a black-powder coating provides a smooth finish.



Drop-Forged
Steel



Zinc Plated



Cold-Drawn
Screw



SPECS

Product Number	Max Opening	Clamping Force	Depth of Throat
402-D	2 in.	3,300 lb.	2 in.
403-D	3 in.	3,500 lb.	2 3/8 in.
404-D	4 in.	4,100 lb.	2 3/4 in.
406-D	6 in.	5,400 lb.	3 5/8 in.
408-D	8 in.	5,900 lb.	4 1/2 in.
410-D	10 in.	6,200 lb.	5 3/8 in.
412-D	12 in.	9,300 lb.	5 3/4 in.





Pony small carriage C-clamp

Our range of smaller, lightweight carriage C-clamps is designed and manufactured for light-duty industrial service. Bright-plated steel is used throughout, as is zinc plating for the casting, screw, handle, and swivel. Available in a wide variety of sizes and clamping forces, all with full-closing screws.



Cast Iron



Zinc Plated

SPECS

Product Number	Max Opening	Clamping Force	Depth of Throat
231	7/8 in.	900 lb.	1 1/8 in.
232	2 in.	900 lb.	1 in.
233	1 3/8 in.	900 lb.	1 1/2 in.
237	1 1/4 in.	500 lb.	3 1/2 in.
242	2 1/2 in.	1,500 lb.	1 3/8 in.
243	3 in.	1,500 lb.	1 3/8 in.
244	2 1/2 in.	2,200 lb.	2 1/2 in.
245	2 3/8 in.	2,400 lb.	4 3/4 in.
246	2 3/8 in.	2,400 lb.	6 1/4 in.



Pony carriage C-clamp

Pony's heavy-duty carriage C-clamps are the most universally used general-purpose C-clamps for regular-duty industrial service. Clamp frames are liberally proportioned and heat treated for maximum strength, and ribbed to resist side strain. Longer frame hubs combined with a copper-coated screw with special smoothly cut acme square threads ensure lasting durability. Black-powder-coated castings.



Cast Iron



Zinc Plated



Acme-Thread
Screw



SPECS

Product Number	Max Opening	Clamping Force	Depth of Throat
102	2 1/2 in.	1,400 lb.	1 3/4 in.
103	3 in.	1,800 lb.	1 7/8 in.
104	4 in.	2,400 lb.	2 1/8 in.
105	5 in.	2,400 lb.	2 1/2 in.
106	6 in.	2,400 lb.	2 3/4 in.
108	8 in.	2,400 lb.	3 1/4 in.
110	10 in.	2,400 lb.	3 5/8 in.
112	12 in.	2,400 lb.	3 5/8 in.





HAND AND SPRING CLAMPS

Get complete clamping flexibility with Pony Jorgensen hand and spring clamps. Our classic steel spring clamps are some of the most durable clamps available, and our hand clamps allow for pressure adjustments to meet any woodworking need.



Classic Pony spring clamp

When you need instant, easy application and removal, turn to the proven durability of classic Pony spring clamps. Throughout the clamp's range of opening, the point of pressure always remains at the lightweight zinc-plated steel jaw tips to ensure they'll hold it together exactly where you need them. Optional poly-vinyl protected handles and jaw tips mean you can use them on metal, wood, plastic, fabric, and beyond. And their contoured handles won't dig into your hands.



Steel Jaws



Zinc Plated

SPECS

Product Number	Protected Handle and Tips	Max Opening	Reach
3201	Without	1 in.	1 1/4 in.
3201-HT	With	1 in.	1 1/4 in.
3202	Without	2 in.	2 in.
3202-HT	With	2 in.	2 in.
3203	Without	3 in.	3 in.
3203-HT	With	3 in.	3 in.
3204-HT	With	4 in.	4 in.



Pony adjust-a-clamp spring clamp

Control exactly how much pressure you apply to your projects with the Pony adjust-a-clamp spring clamp. With the turn of a screwdriver, you can change the pressure between one and 50 pounds of clamping force for precise control in light-duty applications. Lightweight plastic jaws deliver comfortable yet durable use, and the soft pivoting jaw pads easily hold irregular-shaped objects and protect workpieces.



Steel Spring

SPECS

Product Number	Opening	Reach
3251	1 in.	1 1/4 in.
3252	2 in.	2 1/8 in.

Pony hand clamp

Pony hand clamps feature an innovative box-joint design that prevents twisting and keeps the jaws square and straight. Our one-of-a-kind adjustment mechanism allows you to adjust clamping pressure to your desired needs without any additional tools. The soft pivoting jaw pads are ideal for holding delicate work and are riveted to the jaws to ensure they never come off. Soft handles are ergonomically designed for comfortable use.



Patented Feature



Ergonomic Grip



SPECS

Product Number	Max Opening
32150	1 1/2 in.
32225	2 in.
32400	4 in.





BAND CLAMPS

Keep your next round, rectangular, or irregularly shaped woodworking project together with our range of quality nylon, canvas, and rapid-acting band clamps, made with premium features like self-locking mechanisms and ergonomic grips.



Classic Pony band clamp

The classic Pony band clamp is small, lightweight, and easy to work with, featuring a high-strength band made of nylon webbing, four plastic corners to clamp miter joints, and a positive-hold, self-locking aluminum cam and ratcheting handle for instant release. A black rust-resistant finish is applied to the steel frame for added durability.



Steel Frame

SPECS

Product Number	Band Length	Band Width	Band Limit
1215	15 ft.	1 in.	1,000 lb.



Pony rapid-acting band clamp

Our Pony rapid-acting band clamp is great for any oddly shaped project. Its plastic jaws ensure a great fit on corners without marring your workpiece. Its ergonomic grip ensures a great fit in your hands.



Rapid Action



Ergonomic Grip



SPECS

Product Number	Band Length	Band Width	Band Limit
1225	15 ft.	1 in.	1,000 lb.

Pony canvas band clamp

Looking for a band clamp for larger projects? Our heavy-duty Pony canvas band clamp is made with the highest-grade ductile cast iron and features dual self-locking mechanisms, which allow the band to be pulled tight from both sides. The screw and crank handle can be used for final clamping adjustments.



Cast Iron



SPECS

Product Number	Band Length	Band Width	Band Limit
6210	10 ft.	2 in.	2,800 lb.
6220	20 ft.	2 in.	2,800 lb.
6230	30 ft.	2 in.	2,800 lb.





CORNER AND FRAMING CLAMPS

Woodworkers specializing in cabinetry and framing have long trusted Pony Jorgensen clamps. We provide a range of high-quality corner, angle, and framing clamps that make it easier to create a perfect miter, butt, or T-joint.



Pony corner and splicing clamp

Easily clamp miter joints and butt joints with Pony corner and splicing clamps. The die-cast aluminum frame and sliding jaws hold workpieces up to three inches wide and leave joints fully exposed for miter correction, doweling, gluing, or nailing. Plated cold-drawn steel screws with smoothly rolled threads ensure durability and reliability. Two countersunk holes allow you to mount the clamps to benchtops. Available in 90-degree or adjustable-angle variations.



Aluminum Frame



Cold-Drawn Screw

SPECS

Product Number	Description
9133	Pony 3 in. corner and splicing clamp adjustable to any angle 0° to 180°
9166	Pony 3 in. 90° corner clamp



Pony angle clamp with table clamps

The Pony angle clamp with table clamps is perfect for framing and cabinet assembly. Its plastic-coated die-cast jaws won't damage your workpiece surfaces, and the rear jaw swivels allow for easy adjustments, depending on material thickness. Generous clearance is provided for gluing, doweling, or stapling material, and acme-threaded screws ensure maximum strength. Use with confidence for miters and butt joints up to two inches, and for T-joints up to 1 1/8 inches.



Acme-Thread Screw

SPECS

Product Number	Description
9180	Angle clamp with 2 table clamps

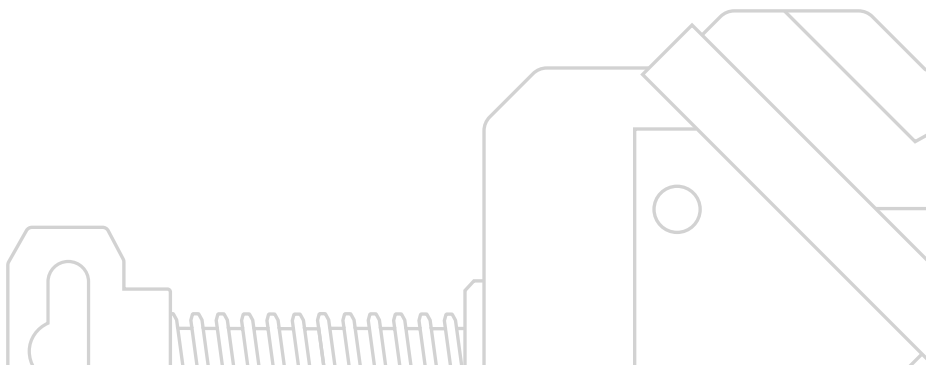

Pony four-corner framing clamp

The complete Pony four-corner framing clamp kit is ideal for fine framing, and it includes plated-steel threaded rods, lightweight plastic corners, and durable plated-zinc alloy thumbnuts. Adjust the size for any square or rectangular project.



Zinc Plated

SPECS

Product Number	Size
9424	24 in.
9448	48 in.



Pony self-squaring frame clamp

Pony's self-squaring framing clamp is ideal for picture frame assembly. It clamps all four corners of a frame at the same time for consistent results. Reversible jaws allow for use with both small and large frames, from 5 x 7 in. to 26 x 30 in. Easily fold it up after you're done for compact storage.



Aluminum Rails

SPECS

Product Number	Description
88094	Pony self-squaring frame clamp

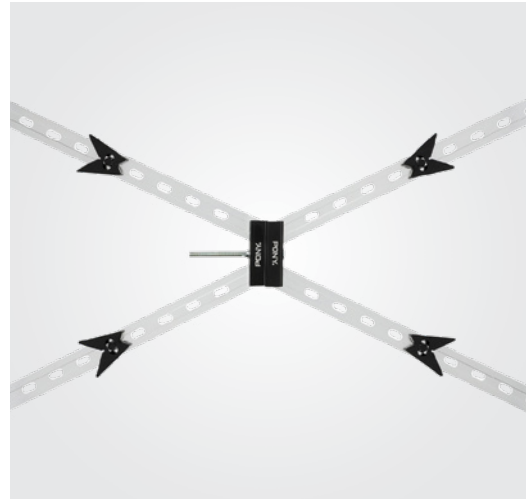



SPECIALTY CLAMPS

When a traditional clamp just won't cut it, grab a high-quality Pony Jorgensen specialty clamp. Choose among iconic Jorgensen handscrew clamps, hold-down clamps, cabinet claws, press screws, gear clamps, and edging clamps.



Classic Jorgensen adjustable handscrew

Every Jorgensen handscrew we make is crafted to ensure maximum strength and durability. Seasoned, straight-grain hard maple wood jaws marry with cold-drawn steel spindles and nuts with special double-lead threads. Together they create a handscrew clamp that holds tightly over broad areas, providing greater reach and a wider distribution of pressure than other clamps. The angle between the jaws can be adjusted to fit the work, allowing them to hold odd shapes easily. Our handscrew clamps are easy to apply and remove quickly, and provide protection against marring of finished surfaces. Traditional seasoned hardwood handles are designed for comfort now and for years to come.



Seasoned
Hardwood



Cold-Drawn
Screw

SPECS

Product Number	Jaw Length	Max Opening	Reach
3/0	6 in.	3 in.	2 3/4 in.
0	8 in.	4 1/2 in.	3 7/8 in.
1	10 in.	6 in.	5 in.
2	12 in.	8 in.	6 in.



Jorgensen gear clamp

Lightweight Jorgensen gear clamps are ideal for projects that require constant use of clamping and unclamping. A distinctive power bar design allows for rapid action, and a handy quick-release button allows for the instant release of clamping pressure.



Steel Frame



Rapid Action

SPECS

Product Number	Max Opening	Reach	Clamping Force
38004	4 in.	3 in.	600 lb.
38008	8 in.	3 in.	600 lb.
38012	12 in.	3 in.	600 lb.

Pony cabinet claw

Complete your cabinetry projects in a fraction of the time with Pony cabinet claws. This unique and patented tool combines the various steps of face-frame cabinet installation into one easy process. The high-quality aluminum claws and alignment plate have protective pads to cushion and protect cabinetry.



Aluminum Claws



Patented Feature

SPECS

Product Number	Description
8510	Pony cabinet claw (2 pack)
8511	Pony cabinet claw



Pony three-way edging clamp

When you need to repair molding, decorative trim, countertop edging, or veneer strips, trust the Pony three-way edging clamp. This cast-iron orange-powder-coated clamp provides a convenient, practical method for applying right-angle pressure to the edge or side of any workpiece.



Cast Iron



SPECS

Product Number	Max Opening	Clamping Force	Depth of Throat
3325	2 1/4 in.	800 lb.	2 1/2 in.

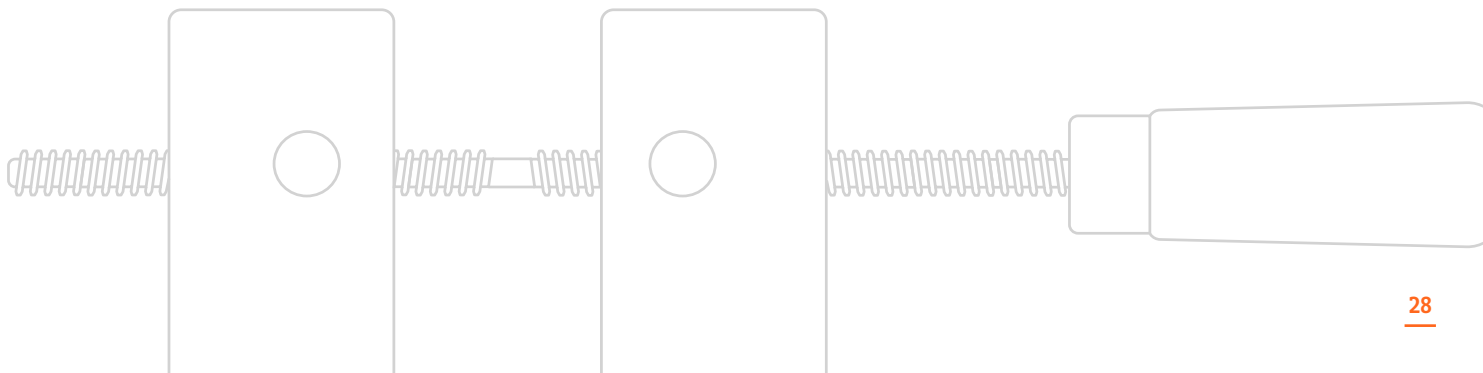



Pony hold-down clamp

Pony hold-down clamps offer the advantage of benchtop and machine-table “surface” clamping. They are designed to rotate a full 360 degrees around the holding bolt and can be used on any wood or metal surface. Our heavy-duty hold-down clamp is designed to be mounted anywhere a T-slot or machine bolt can be installed, and its unique square-head screw can be tightened with a wrench for a secure hold.



Square-Head
Screw

MEDIUM DUTY

Product Number	Opening	Throat Depth	Clamping Force
1623	3 in.	1 3/4 in.	2,000 lb.
1623-BA (bolt assembly)	-	-	-

HEAVY DUTY

Product Number	Opening	Throat Depth	Clamping Force
1834	4 in.	2 1/2 in.	6,000 lb.



Pony bench hold-down clamp

The Pony bench hold-down clamp is a versatile, easy-to-use clamp made for holding work in place on benchtops, and it's made of solid iron with a black baked-enamel finish. Simply tap it into a predrilled hole in your benchtop.



Solid Iron

SPECS

Product Number	Length	Reach	Predrilled Hole
1708	8 in.	4 in.	11/16 in.
1716	16 in.	8 in.	13/16 in.

Pony press screws

Pony heavy-duty press screws are ideal for making veneering frames and are especially useful for deep-reach surface clamping. The large removable cast-iron swivels make installation a breeze, and the threaded bushings fit easily into a one-inch hole. 11/16-inch diameter cold-drawn steel screws with special smoothly cut acme threads provide a tight hold.



Cast Iron

Cold-Drawn
Screw

SPECS

Product Number	Length	Screw Diameter	Swivel Face Size	Handle
6709	9 in.	11/16 in.	13/8 x 1 5/8 in.	Crank
6712	12 in.	11/16 in.	13/8 x 1 5/8 in.	Crank
6718	18 in.	11/16 in.	13/8 x 1 5/8 in.	Crank





VICES

Pony Jorgensen offers a wide range of vises to meet the needs of uncompromising woodworkers, including light-duty, heavy-duty, bench, and drill press vises for home, shop, and professional use.



Pony light-duty clamp-on vise

The Pony light-duty clamp-on vise is ideal for light-duty home, shop, and professional use, featuring plated-steel double guide bars for smooth operation. It mounts easily and securely on edges up to two inches thick, and its portable, lightweight design lets you take it anywhere.



Cast Iron

SPECS

Product Number	Jaw Width	Max Opening	Throat Depth	Pipe Vise Capacity
13025	3 in.	2 1/2 in.	1 1/2 in.	3/8 in. to 1 3/4 in.



Pony light-duty bench vise with swivel base

Consider the Pony light-duty bench vise with swivel base for your light-duty home, shop, and professional use. These vises feature rugged strength you'd usually have to spend more for, with square four-hole swivel bases, sturdy steel jaw faces, ground and polished anvils, permanent pipe jaws, forming horns, and a minimum of 180 degrees of swivel.



Steel Jaws

SPECS

Product Number	Jaw Width	Max Opening	Throat Depth	Pipe Vise Capacity
23530	3 1/2 in.	3 in.	2 in.	5/8 in. to 1 3/8 in.
24545	4 1/2 in.	3 in.	2 5/8 in.	5/8 in. to 1 7/8 in.

Pony light-duty woodworker's vise

This lightweight Pony woodworker's vise is designed for light-duty home and shop use. An acme-threaded main screw and plated-steel twin guide bars allow for smooth operation, and countersunk holes in the jaws are perfect for wood-facing attachments.



Cast Iron



Acme-Thread Screw



SPECS

Product Number	Jaw Width	Max Opening	Throat Depth
26545	6 1/2 in.	4 1/2 in.	2 in.

Pony woodworker's vise

The standard Pony woodworker's vise is fit for both light- and medium-duty applications, featuring double guide bars, continuous screw action, a solid steel dog, and countersunk jaw holes for wood-facing attachments.



Cast Iron



SPECS

Product Number	Jaw Width	Max Opening	Throat Depth
27091	7 in.	8 in.	3 in.

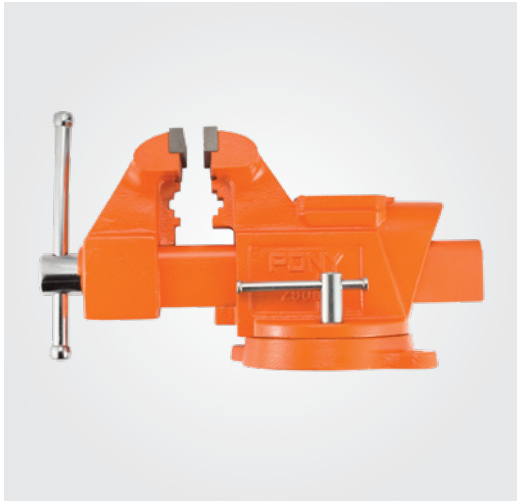

Pony heavy-duty workshop bench vise

This Pony workshop bench vise provides heavy-duty performance, featuring a swivel base with a lock-down nut, hardened-steel serrated jaw faces, a large ground and polished anvil, permanent pipe jaws, and large forming horns.



Steel Jaws



Acme-Thread Screw

SPECS

Product Number	Jaw Width	Max Opening	Throat Depth
29040	4 in.	3 1/2 in.	2 5/8 in.
29050	5 in.	4 in.	3 1/2 in.
29060	6 in.	5 in.	3 3/4 in.



Pony multipurpose vise

The Pony multipurpose vise features rugged strength usually found only in more expensive vises. Ductile iron castings and bright-plated steel hardware allow for extreme durability, and its jaws with countersunk holes rotate and swivel a full 360 degrees.



Cast Iron

SPECS

Product Number	Jaw Width	Max Opening	Throat Depth	Pipe Vise Capacity
29055	5 in.	5 in.	2 5/8 in.	5/8 in. to 2 1/2 in.

Pony drill press vise

Our Pony drill press vise will feel right at home in your personal workshop. A four-inch opening capacity allows you to clamp a wide range of projects for safe drilling, and the slots along each side let you easily mount it to any drill press.



Cast Iron



SPECS

Product Number	Jaw Width	Max Opening
29058	4 in.	4 in.

Pony quick-release vise

The Pony quick-release vise has been designed to handle the toughest heavy-duty applications. Its 360-degree swivel base and dual locks combine with a unique quick-release mechanism that lets you make fast adjustments without having to screw the handle in and out, giving you the ultimate in benchtop performance.



Cast Iron



SPECS

Product Number	Jaw Width	Max Opening	Throat Depth	Pipe Vise Capacity
30105	5 in.	7 in.	3 in.	1 in. to 2 3/8 in.



Jorgensen professional rapid-acting woodworker's vise

The mother of all woodworking vises has arrived. Jorgensen's rapid-acting woodworker's vise sets the bar for quality and performance. Crafted with the finest materials, including a specially cut acme-threaded main screw, cold-drawn steel twin guide bars, and steel handles. A standard quick-action release allows for fast opening and closing, and a solid-steel dog in the front jaw allows for even oversized workpieces to be held securely. The machined, toed-in jaws provide a solid grip, and countersunk jaw holes allow for optional wood facings. This versatile tool also includes an extra nut that allows for conversion to a continuous-acting vise.



Solid Steel



Acme-Thread Screw

SPECS

Product Number	Jaw Size	Max Opening	Weight
40709	4 x 7 in.	9 in.	36 lb.
41012	4 x 10 in.	12 in.	39 lb.



Pony bench dog

The Pony bench dog allows you to hold or secure your work on your benchtop when used with a woodworker's vise front jaw steel dog. It fits into any 3/4-inch benchtop hole.



Solid Steel

SPECS

Product Number	Description
1722	Bench dog

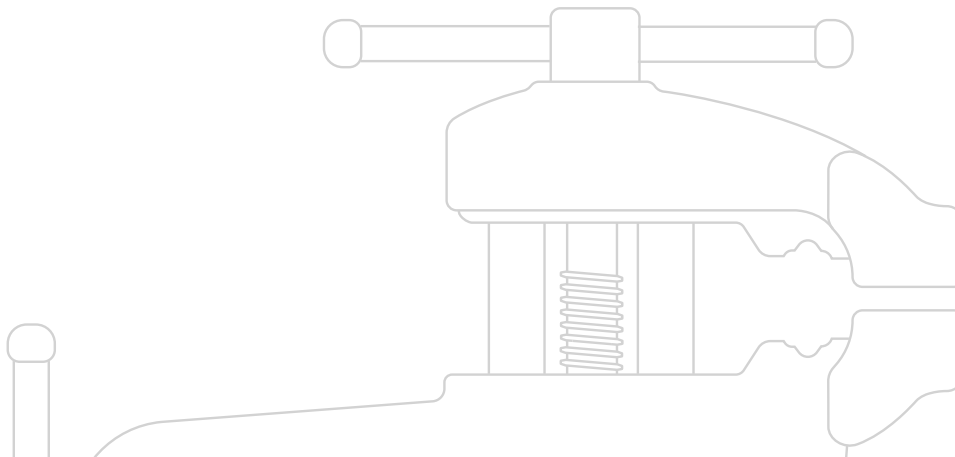

PONY | JORGENSEN®

ponyjorgensen.com

