

Barware
COLLECTION



ONEIDA[®]
Designing the dining experience.™

A Rich Heritage and a

Sparkling Future...

Oneida exists to lead the tabletop industry in innovative, authentic design, working with operators to create unique and unforgettable dining experiences for their guests. Fueled by an unmatched legacy and a forward-thinking mentality, Oneida creates innovative yet timeless solutions designed to match any owner or operator's desired look and feel. Marked by quality, service and dedicated commitment to customers, Oneida offers a dynamic assortment of world-class glassware for any bar service.

Item Descriptions

Throughout the barware catalog you will see information below each item. The guide below helps specify what each description means.



item number — 90254 — symbols
capacity — 14 oz. Beverage — item number
height — H 5 3/8" | D 3 3/8" — diameter
case pack info. — 2 doz. | 22.6 lbs. | 1.03 cu. ft.

● Fully Tempered

■ Rim Tempered

● Proprietary Product

★ 1 Dozen Inner Cartons

▼ Stackable Product

● Can be used with Serving Paddle

● Can be used with Flight Carrier

Table of Contents

BARWARE & TUMBLERS	1-26
STEMWARE	27-30
MARTINI'S	31-32
SPECIALTY	32-34
METAL DRINKWARE	35-36
PERFECT PORTIONS	37-38
SHOT GLASSES & SHOOTERS	39
WATER BOTTLES, PITCHER AND CARAFES	40
DESSERT & COFFEE MUGS	41-42
SALT & PEPPER, VOTIVES & ASHTRAYS	43
CARE & HANDLING	44
TOOLS OF THE TRADE	45
GLASSWARE REQUIREMENTS	46
OUR PROMISE TO YOU & SUREGUARD™ GUARANTEE	47

Brands Featured

ONEIDA®

 **ANCHOR
HOCKING®**





Alpha™



10406 ■
10 oz. Rocks
H 3 ¾" | D 3 ¼"
2 doz. | 16 lbs. | 1.03 cu. ft.



10407 ■
12 oz. DOF
H 3 7/8" | D 3 ½"
2 doz. | 20 lbs. | 1.03 cu. ft.



10408 ■
14 oz. Tea
H 5 ¼" | D 3 3/8"
2 doz. | 20 lbs. | 1.30 cu. ft.



10409 ■
16 oz. Cooler
H 5 3/8" | D 3 3/8"
2 doz. | 25 lbs. | 1.30 cu. ft.

Alpha™

Delivering a classic but contemporary design, Alpha combines the simplicity of a slightly tapered shape together with an upscale weighted base. The handsome style blends nicely with any dinnerware pattern and is wonderful for cocktails, iced teas and lemonade. Alpha is rim-tempered for added durability.





Augusta™



10401 ■
8 oz. Rocks
H 3 1/2" | D 3 3/8"
2 doz. | 17.6 lbs. | 0.1 cu. ft.



10402 ■
11 oz. D.O.F.
H 3 3/4" | D 3 5/8"
2 doz. | 17 lbs. | .1 cu. ft.



10403 ■
12 oz. Collins
H 6 3/8" | D 3"
2 doz. | 25 lbs. | .1 cu. ft.



10404 ■
14 oz. Cooler
H 6" | D 3 1/4"
2 doz. | 24 lbs. | .1 cu. ft.



10405 ■
16 oz. Cooler
H 6 1/4" | D 3 1/4"
2 doz. | 24 lbs. | 1.17 cu. ft.

Augusta™

Augusta Barware from Anchor Hocking delivers an excellent combination of functionality and affordability. Designed in the spirit of Southern Hospitality, Augusta Barware is the perfect choice for any dining establishment seeking a warm welcoming atmosphere. The molded side walls provide the look and feel of cut glass. This durable barware collection is available in five capacities and is rim-tempered for added durability.



Barware Collection



Clarisse™ Stackable



90252 ■ ● ▼
10 oz. Rocks
H 3 5/8" | D 3 1/2"
2 doz. | 22 lbs. | 0.82 cu. ft.



90262 ■ ● ▼
8 oz. Rocks
H 3 1/2" | D 3 1/4"
2 doz. | 16 lbs. | TBD cu. ft.



90253 ■ ● ▼
12 oz. DOF
H 3 7/8" | D 3 5/8"
2 doz. | 26 lbs. | .95 cu. ft.



90254 ■ ● ▼
14 oz. Beverage
H 5 3/8" | D 3 3/8"
2 doz. | 22.6 lbs. | 1.03 cu. ft.



90255 ■ ● ▼
16 oz. Cooler
H 5 3/4" | D 3 5/8"
2 doz. | 25 lbs. | 1.21 cu. ft.



90263 ■ ● ▼
20 oz. Cooler
H 6 1/2" | D 4"
2 doz. | 42 lbs. | 1.66 cu. ft.

Pyramiding is
the preferred
method to
stack & store.

Seamless Design

The stacking seam disappears when beverage is poured into the glass!



Clarisse™



77787 ■ ●
7 oz. Rocks
H 3 3/8" | D 3 1/4"
3 doz. | 26 lbs. | 0.98 cu. ft.



77788R ■ ●
8 oz. Rocks
H 3 3/8" | D 3 1/4"
3 doz. | 24 lbs. | 0.98 cu. ft.



77770 ■ ●
10 oz. Rocks
H 3 3/4" | D 3 1/2"
3 doz. | 33 lbs. | 1.23 cu. ft.



77790R ■ ●
12 oz. Rocks
H 4" | D 3 5/8"
3 doz. | 39 lbs. | 1.42 cu. ft.



77789 ■ ●
9 oz. Hi-Ball
H 4 1/2" | D 3"
3 doz. | 28 lbs. | 1.13 cu. ft.



77792R ■ ●
12 oz. Beverage
H 4 7/8" | D 3 1/4"
3 doz. | 38 lbs. | 1.38 cu. ft.



77794 ■ ●
14 oz. Beverage
H 5 1/8" | D 3 3/8"
3 doz. | 34 lbs. | 1.55 cu. ft.



77796 ■ ●
16 oz. Cooler
H 6 1/8" | D 3 3/8"
3 doz. | 38 lbs. | 1.82 cu. ft.



1170U ●
10 oz. Beer
H 5 7/8" | D 4 7/8"
1 doz. | 25 lbs. | .78 cu. ft.



1172U ●
12 oz. Beer
H 5 7/8" | D 4 7/8"
1 doz. | 21 lbs. | .78 cu. ft.



New Orleans



90004
4 ½ oz. Rocks
H 3 ⅛" | D 2 ⅞"
3 doz. | 23 lbs. | 0.73 cu. ft.



90005
5 oz. Rocks
H 3 ⅛" | D 2 ⅞"
3 doz. | 20 lbs. | 0.77 cu. ft.



90006 ■
7 oz. Rocks
H 3 ⅜" | D 2 ⅞"
3 doz. | 27 lbs. | 1.01 cu. ft.



90007 ■
8 oz. Rocks
H 3 ⅜" | D 3 ⅞"
3 doz. | 27 lbs. | 1.06 cu. ft.



90008 ■
9 oz. Rocks
H 3 ⅜" | D 3 ⅜"
3 doz. | 22 lbs. | 1.07 cu. ft.



799U
9 oz. Rocks
H 3 ⅞" | D 3 ½"
3 doz. | 30 lbs. | 1.26 cu. ft.



90009
10 oz. Rocks
H 3 ⅞" | D 3 ½"
3 doz. | 30 lbs. | 1.27 cu. ft.



90010 ■
12 oz. Double Rocks
H 4 ¼" | D 3 ⅞"
3 doz. | 36 lbs. | 1.61 cu. ft.



7729U ■
9 oz. Hi-Ball
H 4 ¾" | D 3 ⅞"
3 doz. | 35 lbs. | 1.28 cu. ft.



7730U ■
10 oz. Beverage
H 4 ¾" | D 3 ⅞"
3 doz. | 30 lbs. | 1.28 cu. ft.



7732U ■
12 oz. Beverage
H 4 ⅞" | D 3 ⅞"
3 doz. | 36 lbs. | 1.51 cu. ft.



7745U ■
14 ½ oz. Iced Tea
H 5 ⅞" | D 3 ⅞"
3 doz. | 38 lbs. | 1.79 cu. ft.



7733U ■
12 oz. Cooler New Orleans
H 5 ⅞" | D 3 ⅞"
3 doz. | 34 lbs. | 1.54 cu. ft.



7746 ■
16 oz. Cooler New Orleans
H 6 ⅜" | D 3 ⅞"
3 doz. | 40 lbs. | 1.98 cu. ft.



7772 ■
22 oz. Iced Tea New Orleans
H 7" | D 3 ¾"
2 doz. | 37 lbs. | 1.72 cu. ft.

■ Rim
Tempered



Omega™



90236 ■
16 oz. Cooler
H 6 3/8" | D 3 3/8"
1 doz. | 20.5 lbs. | 0.24 cu. ft.



90235 ■
13 1/2 oz. Beverage
H 5 5/8" | D 3 3/8"
1 doz. | 18.4 lbs. | 0.19 cu. ft.



90234 ■
12 oz. Rocks
H 4 1/2" | D 3 1/2"
1 doz. | 17.6 lbs. | 0.17 cu. ft.



90270 ■
10 oz. Rocks
H 4 1/8" | D 3 1/2"
1 doz. | 9 lbs. | 0.92 cu. ft.



90237
6 oz. Carafe
H 5 3/4" | D 2 1/4"
2 doz. | 11.6 lbs. | 0.70 cu. ft.

Omega™

The Omega Collection is ideal for any operations requiring high fashion trend-forward barware. Thick bases and flared tops offer and upscale appearance and service.

The 6 oz. Carafe is perfect for portion control and wine table service. Rim-tempered for added durability, Omega is ideal for fast paced establishments.

■ Rim
Tempered





Reality™



90072 ■
8 oz. Rocks
H 3 ¼" | D 3 ⅜"
2 doz. | 14 lbs. | 0.91 cu. ft.



90044 ■
10 oz. Rocks
H 3 ¾" | D 3 ⅜"
2 doz. | 14 lbs. | 0.91 cu. ft.



90045 ■
12 oz. Rocks
H 3 ⅞" | D 3 ½"
2 doz. | 14 lbs. | 0.91 cu. ft.



90046 ■
14 oz. Tumbler
H 5 ⅞" | D 3 ¼"
2 doz. | 17 lbs. | 1.06 cu. ft.



90047 ■
16 oz. Cooler
H 5 ⅝" | D 3 ¼"
2 doz. | 23 lbs. | 1.06 cu. ft.



90048 ■
20 oz. Cooler
H 6" | D 3 ½"
2 doz. | 25 lbs. | 1.27 Cu. ft.

Reality™

The Reality pattern is the perfect blend of fashion, sophistication, elegance and durability. The nicely proportioned stylish design brings an upscale look to the handsome piece, and helps eliminate the rim-to-rim contact. The substantial base delivers a cut crystal look typical of high-end glassware and adds stability to the table. Rim-tempered for added durability, the controlled bead gives an elegant upscale look to the finely crafted piece. The Reality tumbler makes a great addition to any table setting.



Solace™



90051A ■●
5 oz. Juice
H 3 5/8" | D 2 1/2"
2 doz. | 5 lbs. | 0.56 cu. ft.



90052A ■●
7 oz. Juice
H 3 7/8" | D 3 1/2"
2 doz. | 12 lbs. | 0.75 cu. ft.



90053A ■●
10 oz. Water
H 4 5/16" | D 3 1/4"
2 doz. | 15 lbs. | 1.02 cu. ft.



90054A ■●
15 3/4 oz. Cooler
H 5 5/8" | D 3 1/4"
2 doz. | 21 lbs. | 1.18 cu. ft.

■ Rim Tempered ● Proprietary Product

Solace™

Designed especially for the growing healthcare food market, Solace is a simple, practical and stylish solution to dressing up a table. The heavy base helps reduce tipping and the rim is designed to accept standard plastic lids to prevent spilling while transporting drinks from the kitchen to the table.



Ribware



7637U ■
12 oz. Beverage
H 5 ³/₈" | D 3 ¹/₈"
3 doz. | 26 lbs. | 1.46 cu. ft.



77636 ■
16 oz. Iced Tea
H 6" | D 3 ¹/₄"
3 doz. | 31 lbs. | 1.68 cu. ft.



Vino Redux



11868
16 oz. Cooler
H 5 5/8" | D 3"
2 doz. | 15.6 lbs. | .89 cu. ft.



11869
10 oz. Rocks
H 3 5/8" | D 3"
3 doz. | 15.6 lbs. | .89 cu. ft.



11872
20 oz. Pitcher
H 7 3/4" | D 3 1/2"
1/2 doz. | 6 lbs. | .89 cu. ft.



11870
16 oz. Cooler
H 3 5/8" | D 3"
3 doz. | 15.6 lbs. | .89 cu. ft.



11871
10 oz. Rocks
H 3 5/8" | D 3"
3 doz. | 15.6 lbs. | .89 cu. ft.



11934
20 oz. Pitcher
H 7 3/4" | D 3 1/2"
1/2 doz. | 6 lbs. | .89 cu. ft.

Straight Sided Shells™



3532U ■
12 oz. Zombie
H 6 1/8" | D 2 1/4"
6 doz. | 35 lbs. | 2.01 cu. ft.



3532/6721U
12 oz. Zombie Frosted
H 6 1/8" | D 2 1/4"
6 doz. | 35 lbs. | 2.01 cu. ft.



7511U ■
6 oz. Seltzer
H 3 1/2" | D 2 3/8"
6 doz. | 20 lbs. | 1.08 cu. ft.



7514U ■
10 oz. Collins
H 4 3/4" | D 2 3/4"
6 doz. | 30 lbs. | 1.81 cu. ft.

■ Rim
Tempered



Heavy Base



3108U
8 oz. Hi-Ball
H 4 7/8" | D 2 1/2"
6 doz. | 38 lbs. | 1.64 cu. ft.



3113U
13 oz. Double Rocks
H 4" | D 3 5/8"
3 doz. | 29 lbs. | 1.43 cu. ft.



3165U
5 oz. Side Water
H 3 1/2" | D 2 3/8"
6 doz. | 28 lbs. | 1.08 cu. ft.



3169U
9 oz. Hi-Ball
H 4 3/4" | D 2 5/8"
6 doz. | 39 lbs. | 1.82 cu. ft.



3170U
10 1/2 oz. Hi-Ball
H 5 1/2" | D 2 7/8"
6 doz. | 47 lbs. | 2.37 cu. ft.



3172U
12 1/2 oz. Beverage
H 5 1/2" | D 2 7/8"
6 doz. | 47 lbs. | 2.37 cu. ft.



3175U
15 oz. Iced Tea
H 6 1/4" | D 3"
3 doz. | 30 lbs. | 1.42 cu. ft.



3178FU
9 oz. Rocks
H 3 1/4" | D 3 1/8"
3 doz. | 20 lbs. | 0.91 cu. ft.



3181EU
10 1/2 oz. Collins
H 6" | D 2 1/2"
3 doz. | 22 lbs. | 1.06 cu. ft.

Room Tumblers



639U
8 oz. Rocks
H 3 3/4" | D 3 1/8"
1 doz. | 10 lbs. | 0.36 cu. ft.



2238U
8 oz. Room Tumbler
H 3 5/8" | D 2 3/4"
6 doz. | 38 lbs. | 1.51 cu. ft.



5060U
10 3/4 oz. Room Tumbler
H 3 1/2" | D 3 1/4"
3 doz. | 25 lbs. | .97 cu. ft.



83286
11 oz. Rio Small Tumbler
H 3 3/4" | D 3 1/2"
1 doz. | 8 lbs. | 0.37 cu. ft.



93068
12 oz. Small Tumbler
H 4 1/4" | D 3 5/8"
1 doz. | 10 lbs. | 0.51 cu. ft.



2047U
10 1/4 oz. Old Fashioned
H 3 3/8" | D 3 1/4"
3 doz. | 27 lbs. | 1.05 cu. ft.

Concord



2283Q
3 oz. Juice/Votive/Jigger
H 2 ³/₈" | D 2 ¹/₈"
3 doz. | 10 lbs. | 0.39 cu. ft.



3141U
10 ¹/₂ oz. Old Fashioned
H 3 ¹/₂" | D 3 ¹/₄"
3 doz. | 27 lbs. | 1.05 cu. ft.



3143U
12 ¹/₂ oz. Dbl. Old Fashioned
H 4" | D 3 ¹/₄"
3 doz. | 29 lbs. | 1.19 cu. ft.

Tartan[®]



68349 ●
10 ¹/₂ oz. Rocks
H 3 ¹/₂" | D 3 ³/₈"
1 doz. | 10 lbs. | 0.38 cu. ft.



68347 ●
16 oz. Iced Tea
H 6" | D 3 ¹/₈"
1 doz. | 15 lbs. | 0.53 cu. ft.

Breckenridge[™]



80009 ■
9 oz. Hi-Ball
H 4 ⁷/₈" | D 2 ³/₄"
3 doz. | 23 lbs. | 1.04 cu. ft.



80012 ■
12 ¹/₂ oz. Beverage
H 5 ³/₈" | D 3 ¹/₈"
3 doz. | 25 lbs. | 1.33 cu. ft.



80011 ■
10 ¹/₂ oz. Goblet
H 6" | D 3 ¹/₄"
3 doz. | 35 lbs. | 1.82 cu. ft.

Stackables™



73012 ■ ● ▼
12 oz. Beverage
H 4 7/8" | D 3 1/4"
3 doz. | 23.4 lbs. | 1.4 cu. ft.



73014 ■ ● ▼
14 oz. Beverage
H 5 1/8" | D 3 1/4"
3 doz. | 28.5 lbs. | 1.7 cu. ft.



73017 ■ ● ▼
16 oz. Cooler
H 6" | D 3 1/8"
3 doz. | 35 lbs. | 1.92 cu. ft.



73020 ■ ● ▼
20 oz. Cooler
H 6 1/2" | D 3 3/4"
2 doz. | 32 lbs. | 1.56 cu. ft.

■ Rim Tempered ● Proprietary Product ▼ Stackable Product

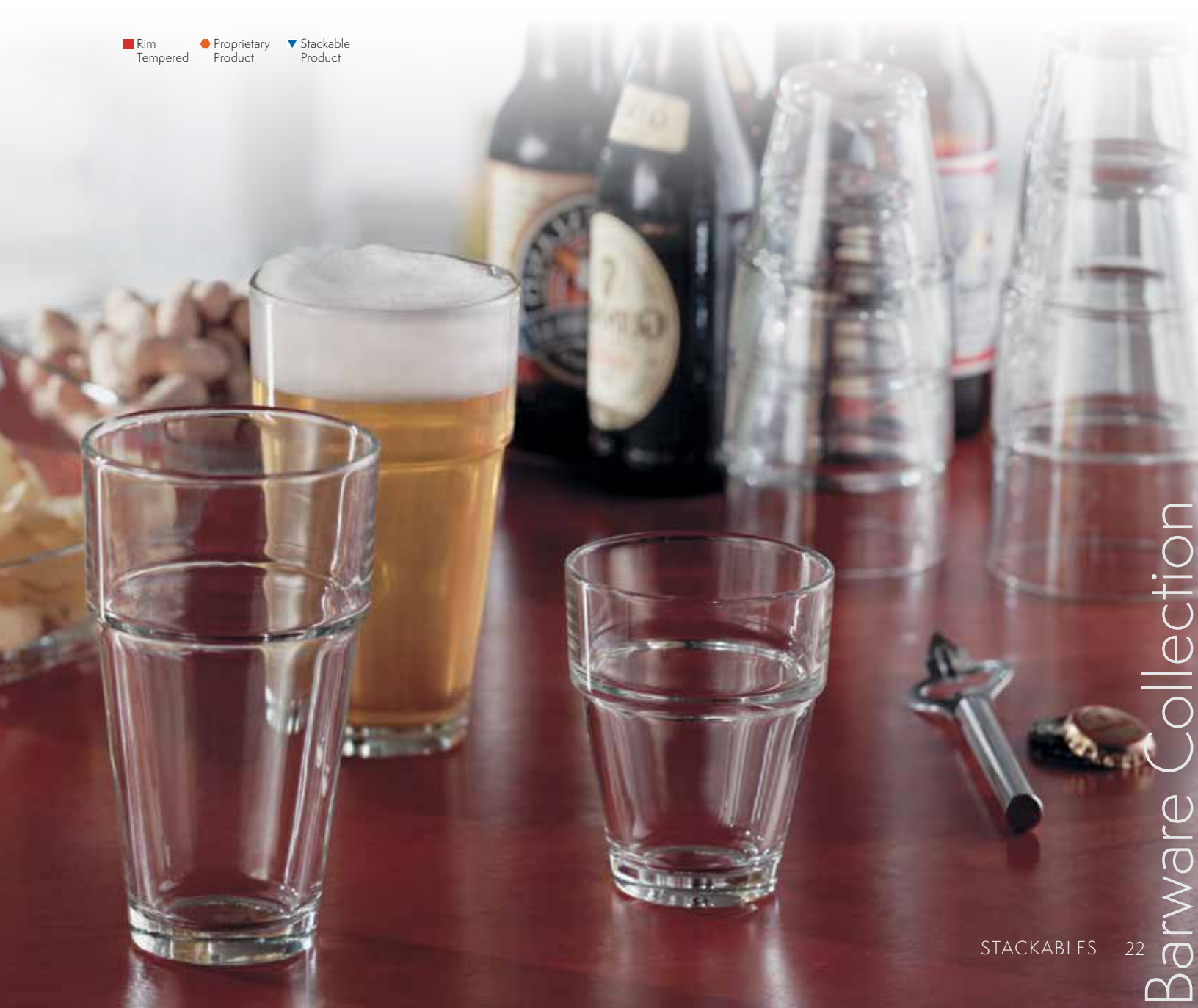

Beer Pilsners



7410U ■
10 oz. Bavarian Pilsner
H 5 3/4" | D 2 7/8"
3 doz. | 23 lbs. | 1.20 cu. ft.



7412U ■
12 oz. Bavarian Pilsner
H 6" | D 3 1/4"
3 doz. | 27 lbs. | 1.59 cu. ft.



7415U ■
15 oz. Bavarian Pilsner
H 6 5/8" | D 3 1/4"
3 doz. | 30 lbs. | 1.91 cu. ft.



90280
23 oz. Cyclonic Beer
H 9" | D 3 3/8"
2 doz. | 22 lbs. | 2.16 cu. ft.



90054A ■
15 3/4 oz. Solace Cooler
H 5 5/8" | D 3 1/4"
2 doz. | 21 lbs. | 1.18 cu. ft.



H023202 ■
14 oz. Treva Pilsner
H 9 3/8" | D 2 7/8"
2 doz. | 26 lbs. | 1.70 cu. ft.



80436RT ■ /80436
23 oz. Pilsner
H 9" | D 3 3/8"
2 doz. | 22 lbs. | 2.16 cu. ft.



165270
13 oz. Empire Pilsner
H 9 3/8" | D 2 7/8"
1/2 doz. | 5.1 lbs. | 0.37 cu. ft.

Table Service

Medium-sized capacity glasses allows for an establishment to provide an upscale service presentation when serving increasingly popular craft beers that are often served in bottles.

Draft Service

Larger capacity glasses are essential for today's beer service, especially for establishments offering a large assortment of draft beers.

Stemmed Beer



2942M

12 oz. Excellency Beer
H 7 ⁷/₈" | D 2 ⁷/₈"
3 doz. | 20 lbs. | 1.63 cu. ft.



90093

13 oz. Belgian Beer
H 5 ³/₄" | D 3 ³/₄"
1 doz. | 11 lbs. | 0.94 cu. ft.



90249

13 oz. Stemmed Beer
H 6 ³/₄" | D 3 ⁵/₈"
1 doz. | 7 lbs. | 0.03 cu. ft.



Beer Mugs



90132
10 oz. Beer Mug
H 5 1/8" | D 4 5/8"
2 doz. | 50 lbs. | 1.15 cu. ft.



1170U
10 oz. Beer Tankard
H 5 7/8" | D 4 7/8"
1 doz. | 25 lbs. | 0.78 cu. ft.



1172U
12 oz. Beer Tankard
H 5 7/8" | D 4 7/8"
1 doz. | 21 lbs. | 0.78 cu. ft.



01814
14 oz. Brew Mug
H 5 7/8" | D 5"
2 doz. | 50 lbs. | 1.42 cu. ft.



01816
16 oz. Brew Mug
H 5 7/8" | D 5"
2 doz. | 42 lbs. | 1.44 cu. ft.



18U
12 oz. Beer Mug
H 5 5/8" | D 4 3/4"
2 doz. | 36 lbs. | 1.27 cu. ft.



1150U
10 oz. Beer Wagon
H 5 1/8" | D 4 3/8"
2 doz. | 31 lbs. | 1.04 cu. ft.



1152U
12 oz. Beer Wagon
H 5 3/4" | D 4 1/2"
2 doz. | 37 lbs. | 1.22 cu. ft.



1153U
1 Litre Gusto Mug
H 8" | D 6"
1 doz. | 39 lbs. | 1.54 cu. ft.



90272
25 oz. Champions Mug
H 7 1/8" | D 5 5/8"
1 doz. | 10 lbs. | 1.42 cu. ft.



162U
Boot Mug 12 1/2 oz.
H 6" | D 5 1/4"
2 doz. | 27 lbs. | 1.46 cu. ft.

Beer & Mixing



77174
14 oz. Mixing Glass RT
H 5 7/8" | D 3 1/2"
3 doz. | 43 lbs. | 1.86 cu. ft.



176FU / 7176FU ■
16 oz. Mixing Glass
H 5 7/8" | D 3 1/4"
2 doz. | 26 lbs. | 1.29 cu. ft.



90055 ■
16 oz. Cooler
H 5 7/8" | D 3 1/4"
2 doz. | 24 lbs. | 1.31 cu. ft.



90300 ■
18 oz. Mixing Glass
H 6 3/4" | D 3 1/2"
2 doz. | 29.7 lbs. | 1.70 cu. ft.



77420 ■
20 oz. Mixing Glass
H 6 7/8" | D 3 5/8"
2 doz. | 33 lbs. | 1.7 cu. ft.



77422 ■
22 oz. Mixing Glass
H 6 7/8" | D 3 5/8"
2 doz. | 27 lbs. | 1.70 cu. ft.



90244
20 oz. English Pub Glass
H 6" | D 3 3/8"
1 doz. | 9 lbs. | 0.04 cu. ft.



90248 ■
16 oz. Pub Glass
H 6 1/2" | D 3"
1 doz. | 8.6 lbs. | 0.48 cu. ft.



90247 ■
20 oz. Pub Glass
H 6 7/8" | D 3 1/4"
1 doz. | 11 lbs. | 0.90 cu. ft.



90243
20 oz. Tulip Beer
H 6 1/4" | D 3 1/4"
1 doz. | 9 lbs. | 0.04 cu. ft.



90245
12 oz. Flared Pilsner
H 7 1/8" | D 3 1/8"
1 doz. | 8 lbs. | 0.75 cu. ft.



90279
16 oz. Cyclonic Beer
H 5 7/8" | D 3 1/4"
2 doz. | 26 lbs. | 1.29 cu. ft.



Florentine



80013
13 oz. Red Wine
H 7 3/8" | D 3 5/8"
2 doz. | 13 lbs. | 1.64 cu. ft.



80018
8 1/2 oz. Wine
H 7 1/4" | D 2 7/8"
2 doz. | 11 lbs. | 1.12 cu. ft.



80019
6 oz. Flute
H 8 1/8" | D 2 1/8"
2 doz. | 10 lbs. | .99 cu. ft.



80021
11 oz. All Purpose Wine
H 7 3/8" | D 3 1/4"
2 doz. | 13 lbs. | 1.37 cu. ft.

Carmona



96582 ●
14 oz. White Wine
H 8 1/4" | D 3 1/4"
1 doz. | 9 lbs. | 0.92 cu. ft.

Grand Wine



90240
13 oz. All Purpose
H 8" | D 3 1/8"
1 doz. | 7 lbs. | 0.17 cu. ft.



90241
11 oz. All Purpose
H 7 3/4" | D 3"
1 doz. | 6 lbs. | 0.16 cu. ft.

● Fully
Tempered

Excellency Stemware



2926M
6 ½ oz. Wine
H 5 ¾" | D 2 ⅞"
3 doz. | 14 lbs. | 1.27 cu. ft.



2928M
8 ½ oz. Wine
H 5 ⅝" | D 3"
3 doz. | 19 lbs. | 1.41 cu. ft.



2930M
10 ½ oz. Wine
H 6" | D 3 ⅜"
3 doz. | 19 lbs. | 1.80 cu. ft.



2932M
11 ½ oz. Goblet
H 6" | D 3 ⅞"
3 doz. | 20 lbs. | 1.72 cu. ft.



2936M
6 ½ oz. Wine
H 6 ¼" | D 2 ½"
3 doz. | 15 lbs. | 1.22 cu. ft.



2938M
8 ½ oz. Wine
H 6 ⅜" | D 2 ¾"
3 doz. | 16 lbs. | 1.46 cu. ft.



7221M
10 ½ oz. Goblet
H 5 ¼" | D 3 ⅞"
3 doz. | 20 lbs. | 1.40 cu. ft.



10565
16 oz. Water Goblet
H 7" | D 3 ½"
½ doz. | 7 lbs. | 0.38 cu. ft.



H001551
12 oz. Tall Wine
H 8" | D 3 ¼"
1 doz. | 12 lbs. | .75 cu. ft.



H001420
12 oz. White Wine
H 7 ⅞" | D 3 ¼"
1 doz. | 10 lbs. | 0.74 cu. ft.



H001421
8 ½ oz. White Wine
H 5 ⅜" | D 2 ⅞"
3 doz. | 18 lbs. | 1.52 cu. ft.

Excellency Stemware



2907M
7 oz. Footed Rocks
H 4 3/8" | D 3 1/4"
3 doz. | 20 lbs. | 1.28 cu. ft.



2908M
8 oz. Footed Hi-Ball
H 5 3/8" | D 2 3/4"
3 doz. | 20 lbs. | 1.25 cu. ft.



2910M
10 oz. Footed Hi-Ball
H 6" | D 2 7/8"
3 doz. | 21 lbs. | 1.39 cu. ft.



2942M
12 oz. Pilsner
H 7 1/8" | D 2 7/8"
3 doz. | 20 lbs. | 1.63 cu. ft.



3933M
9 oz. Brandy
H 4 1/2" | D 3 3/8"
2 doz. | 12 lbs. | 0.97 cu. ft.



3951M
12 oz. Brandy
H 4 3/4" | D 3 5/8"
2 doz. | 13 lbs. | 1.20 cu. ft.



2085M
13 1/2 oz. Pocò
H 7" | D 3 3/4"
1 doz. | 9 lbs. | 0.69 cu. ft.



H001238
7 1/4 oz. Flute Champagne
H 8 1/4" | D 2 1/2"
1 doz. | 6 lbs. | 0.49 cu. ft.



Martini



90063 ●●
2 ½ oz. Mini Martini
H 3 ¼" | D 3 ¼"
3 doz. | 17 lbs. | 0.22 cu. ft.



90064 ●●
2 ½ oz. Mini Martini
H 4 ¾" | D 3 ⅞"
3 doz. | 18 lbs. | 0.54 cu. ft.



H037491
6 oz. Martini
H 5 ¾" | D 4 ⅞"
3 doz. | 17 lbs. | 2.46 cu. ft.



H037524
4 ½ oz. Martini
H 5 ½" | D 3 ⅞"
3 doz. | 18 lbs. | 2.15 cu. ft.



H037525
10 oz. Ashbury Martini
H 6 ¾" | D 4 ⅜"
1 doz. | 8 lbs. | 1.18 cu. ft.



80226X ●
9 oz. Martini
H 7" | D 4 ½"
1 doz. | 7 lbs. | 1.20 cu. ft.



80278X ●
9 oz. Martini
H 6 ¾" | D 4 ½"
1 doz. | 7 lbs. | 1.23 cu. ft.



90032
10 ½ oz. Executive Martini
H 8 ¼" | D 4 ⅓"
1 doz. | 6 lbs. | 1.92 cu. ft.





03212

18 oz. Weiss Goblet
H 7 1/2" | D 4 3/4"
1 doz. | 37.7 lbs. | 1.88 cu. ft.

07767

20 oz. Weiss Goblet
H 7 1/2" | D 5"
1 doz. | 36 lbs. | 1.82 cu. ft.

07338

32 oz. Weiss Goblet
H 8" | D 5 3/8"
1 doz. | 37.5 lbs. | 2.44 cu. ft.



3959RTX ●■

16 oz. Hoffman House Goblet
H 5 3/4" | D 4"
2 doz. | 16 lbs. | 1.55 cu. ft.



10024

Tiki Cooler 16 oz.
H 6 1/4" | D 3"
2 doz. | 25 lbs. | 1.32 cu. ft.

● Proprietary Product ■ Rim Tempered

Specialty



90062 ●●
3 oz. Mini Wine
H 4 7/8" | T 1 7/8"
B 1 7/8" | D 2 1/4"
3 doz. | 11 lbs. | 0.54 cu. ft.



80019 ●
6 oz. Flute
H 8 1/8" | T 1 7/8"
B 2 1/2" | D 2 1/8"
2 doz. | 10 lbs. | .99 cu. ft.



H001238
7 1/4 oz. Flute
H 8 1/4" | T 2 1/4"
B 2 3/4" | D 2 1/2"
1 doz. | 6 lbs. | 0.49 cu. ft.



2451RTX
9 oz. Tulip Champagne
H 8 1/2" | T 2"
B 2 7/8" | D 2 3/4"
1 doz. | 7 lbs. | .69 cu. ft.



2912UX
12 oz. Margarita
H 6 1/8" | D 4 3/8"
2 doz. | 17 lbs. | 2.54 cu. ft.



2914UX
14 oz. Margarita
H 6" | D 4 1/2"
1 doz. | 9 lbs. | 1.31 cu. ft.



2095UX
15 1/4 oz. Margarita
H 6" | D 4 7/8"
1 doz. | 9 lbs. | 1.36 cu. ft.



2917UX
16 3/4 oz. Margarita
H 6 1/4" | D 5"
1 doz. | 10 lbs. | 1.39 cu. ft.



524UX
15 oz. Hurricane
H 8 1/4" | D 3 1/8"
1 doz. | 11 lbs. | 0.74 cu. ft.



2085M
13 1/2 oz. Poco
H 7" | D 3 3/8"
1 doz. | 9 lbs. | 0.69 cu. ft.



Metal Drinkware

The traditional copper mug is said to enhance the temperature, the aroma, and the overall experience of the Moscow mule. But in modern bars and restaurants, you will find gold, stainless steel, and a variety of colors to not only serve the mixologists' latest crafted cocktails, but appetizers, side dishes, and desserts as well.



MM1600AC
16 oz. Hammered Mug
Antique Copper
H 4 1/9" | D 3 3/8"
1 doz. | 6.25 Lbs | 0.63 cu. ft



MM1600CP
16 oz. Hammered Mug
Copper Plated
H 4 1/9" | D 3 3/8"
1 doz. | 6.25 Lbs | 0.63 cu. ft



MM1600SS
16 oz. Hammered Mug
Stainless Steel
H 4 1/9" | D 3 3/8"
1 doz. | 6.25 Lbs | 0.63 cu. ft



MM1600GD
16 oz. Hammered Mug
Gold PVD
H 4 1/9" | D 3 3/8"
1 doz. | 6.25 Lbs | 0.63 cu. ft

Perfect Portions



90062 ●●
3 oz. Mini Wine
H 4 ⁷/₈" | D 2 ¹/₄"
3 doz. | 11 lbs. | 0.54 cu. ft.



90063 ●●●
2 ¹/₂ oz. Mini Martini
H 3 ¹/₄" | D 3 ¹/₄"
3 doz. | 17 lbs. | 0.22 cu. ft.



90064 ●●●
2 ¹/₂ oz. Mini Martini
H 4 ³/₄" | D 3 ¹/₈"
3 doz. | 18 lbs. | 0.54 cu. ft.

Barbary



93011 ●●
16 oz. Beer
H 6 1/8" | D 3 1/4"
2 doz. | 17 lbs. | 1.90 cu. ft.



93012 ●●
13 oz. Beer
H 6 1/4" | D 2 3/4"
2 doz. | 10 lbs. | 1.44 cu. ft.



93013A* ●●●
5 oz. Beer
H 4" | D 2 1/2"
2 doz. | 6 lbs. | 0.72 cu. ft.

Tasters and Shots

Tasters and shot glasses from Anchor Hocking offer an excellent opportunity for any establishment to pre-sell or up-sell their beverage service by providing truly unique presentations that can be tailored to any décor.

Score Bigger Profits

Use serving paddles to increase your sales and profits. Serve customers four different beers (for your 13 oz. price) using 4.5 oz. taster.



90038 ●
Serving Paddle
H 5/8" | L 14 1/2"
1 doz. | 8 lbs. | .30 cu. ft.

11938
Serving Paddle - Acacia Wood
H 5/8" | L 14 1/2"
1 doz. | 14 lbs. | .39 cu. ft.

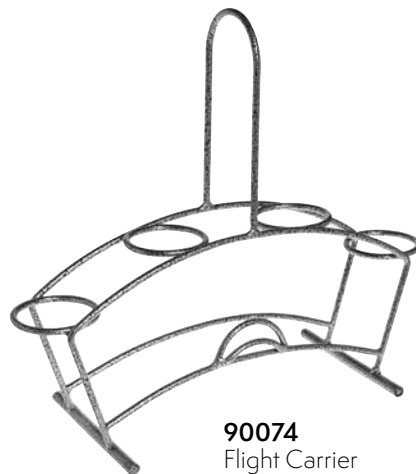

90074
Flight Carrier
H 7" | D 5 1/4"
1 doz. | 14 lbs. | 4.03 cu. ft.



● Proprietary Product ● Can be used with Serving Paddle

Shot Glasses & Shooters



163Q
3 ½ oz. Taster
H 2 ¾" | D 2"
3 doz. | 8 lbs. | 0.39 cu. ft.



2283Q
3 oz. Whiskey/Taster
H 2 ⅝" | D 2 ⅛"
3 doz. | 10 lbs. | 0.39 cu. ft.



3661U
1 ½ oz. Whiskey
H 2 ¼" | D 2"
6 doz. | 16 lbs. | 0.55 cu. ft.



3666EU ★
¾ oz. Whiskey
H 2 ¼" | D 1 ⅞"
6 doz. | 26 lbs. | 0.83 cu. ft.



3668U
1 oz. Whiskey
H 2 ¼" | D 2"
6 doz. | 22 lbs. | 0.55 cu. ft.



5280VU ★
1 ¼ oz. Whiskey
H 2 ⅞" | D 2 ¼"
6 doz. | 43 lbs. | 1.15 cu. ft.



5281U ★
1 ½ oz. Whiskey
H 2 ⅞" | D 2 ¼"
4 doz. | 27.5 lbs. | 0.77 cu. ft.



5280/1612UL
1 ¼ oz. Line Whiskey
(with ½ oz. cap line)
H 2 ⅞" | D 2 ¼"
6 doz. | 43 lbs. | 1.15 cu. ft.



5281/931U ★
1 ½ oz. Line Whiskey
(with ¾ oz. cap line)
H 2 ⅞" | D 2 ¼"
4 doz. | 27.5 lbs. | 0.77 cu. ft.



5281/932U ★
1 ½ oz. Line Whiskey
(with ⅞ oz. cap line)
H 2 ⅞" | D 2 ¼"
4 doz. | 27.5 lbs. | 0.77 cu. ft.



5282/928U ★
2 oz. Line Whiskey
(with 1 oz. cap line)
H 2 ⅞" | D 2 ¼"
4 doz. | 23.3 lbs. | 0.77 cu. ft.



5282U
2 oz. Whiskey
H 2 ⅞" | D 2 ¼"
4 doz. | 23.3 lbs. | 0.77 cu. ft.



3667EU
⅞ oz. Whiskey Glass
H 2 ¼" | D 2"
6 doz. | 24 lbs. | 0.79 cu. ft.



90246
1 ½ oz. Tequila Shooter
H 2 ⅞" | D 1 ¾"
6 doz. | 24 lbs. | 0.62 cu. ft.



90069
3 ½ oz. Beer Taster Mug
H 3 ¼" | D 3 ⅜"
6 doz. | 41 lbs. | 1.38 cu. ft.



90063 ● ● ● ●
2 ½ oz. Mini Martini
H 3 ¼" | D 3 ¼"
3 doz. | 29 lbs. | 0.22 cu. ft.



82412
1 oz. Kitchen Shot (with blue decoration)
H 2 ⅓" | D 2"
2.93 lbs 0.11 cu.ft

Water Bottles



11935
¼ L Round Water Bottle
(with ceramic cap)
H 8" | D 3"
2 doz. | 8.4 lbs. | .69 cu. ft.



11936
½ L Round Water Bottle
(with ceramic cap)
H 10" | D 3½"
1 doz. | 11.90 lbs. | .69 cu. ft.



11937
1 L Round Water Bottle
(with ceramic cap)
H 12½" | D 3½"
1 doz. | 18.3 lbs. | 1.44 cu. ft.



W99247R
750 mL Stockholm Bottle
H 8¾" | D 4"
½ doz. | 10.3 lbs. | .58 cu. ft.



W99248
750 mL Milan Bottle
H 8¾" | D 4"
½ doz. | 10.3 lbs. | .58 cu. ft.



W99247R
750 mL Edinburgh Bottle
H 8¾" | D 4"
½ doz. | 10.3 lbs. | .58 cu. ft.



93411R
750 mL Stockholm Bottle
H 8¾" | W 4" | D 4"
½ doz. | 10.3 lbs. | .58 cu. ft.



93221
2 qt. Bistro Pitcher w/White Stopper
H 10¼" | W 5½" | D 3¼"
½ doz. | 10.3 lbs. | .58 cu. ft.

Pitcher & Carafes



1155UR ■
55 oz. Beer Wagon Pitcher
H 9 ⅞" | D 7"
½ doz. | 24 lbs. | 1.20 cu. ft.



121UR
½ L Carafe
H 9" | D 3 ¼"
1 doz. | 16 lbs. | 0.86 cu. ft.



139UR
1 L Carafe
H 11" | D 4 ⅞"
1 doz. | 25 lbs. | 1.62 cu. ft.



93084
1 L Carafe (with lid)
H 11" | D 4 ⅞"
½ doz. | 13.6 lbs. | .81 cu. ft.

■ Rim
Tempered



Dessert



575GU
4 ½ oz. Footed Sherbet
H 4 1/8" | D 3 5/8"
3 doz. | 20 lbs. | 1.32 cu. ft.



563FU
5 ½ oz. Tulip Sundae
H 6" | D 4"
3 doz. | 31 lbs. | 2.49 cu. ft.



562U
12 ½ oz. Soda
H 6 3/4" | D 3 5/8"
3 doz. | 40 lbs. | 2.26 cu. ft.



90060
16 oz. Soda Glass
H 8 1/4" | D 3 5/8"
1 doz. | 20 lbs. | 1.12 cu. ft.



56EU
5 oz. Waverly Sherbet
H 2 1/4" | D 3 3/4"
3 doz. | 15 lbs. | 0.51 cu. ft.



561G
8 ¼ oz. Banana Split
H 1 5/8" | D 8 1/4"
1 doz. | 10 lbs. | 0.48 cu. ft.

La Rochere



622301
1 ½ oz. Mini Bubble
H 2 ½" | D 3 ⅛"
1 doz. | 3.1 lbs. | 0.19 cu. ft.



617801
4 ½ oz. Bubble
H 3 ⅝" | D 4 ¾"
1 doz. | 11.4 lbs. | 0.56 cu. ft.



617901
5 oz. Vega Cup - Clear
H 3 ⅞" | D 3 ¾"
1 doz. | 6.3 lbs. | 0.42 cu. ft.



628701
8 ½ oz. Cafet Cup
H 2 ⅜" | D 5"
1 doz. | 6.3 lbs. | 0.70 cu. ft.



608601
6 ½ oz. Diamond Cup
H 3 ⅜" | D 4 ⅜"
1 doz. | 6.1 lbs. | 0.42 cu. ft.



604001
7 oz. Fidji Sundae
H 6" | D 4"
1 doz. | 11.9 lbs. | 0.84 cu. ft.



605001
7 ½ oz. Omega Dish
H 5" | D 5"
1 doz. | 11.1 lbs. | 1.02 cu. ft.



618601
13 ½ oz. Elise Dish
H 4 ⅞" | D 5"
1 doz. | 10.7 lbs. | 0.91 cu. ft.



627701
7 ½ oz. Champagne Cup
H 3 ⅞" D 4"
12 doz. | 8.1 lbs. | 0.64 cu. ft.

Coffee Mugs



308U
8 oz. Irish Coffee
H 5 ¼" | D 4"
2 doz. | 20 lbs. | 1.05 cu. ft.



90284
14 oz. Rio Mug
H 4" | D 3 ½"
1 doz. | 12 lbs. | 0.61 cu. ft.



83037A ●
14 oz. Mocha Mug
H 5 ⅞" | D 5 ¼"
½ doz. | 7 lbs. | 0.45 cu. ft.



83045A ●
16 oz. Cafe Mug
H 5" | D 5 ¼"
½ doz. | 7 lbs. | 0.42 cu. ft.

Salt & Pepper



1830EU
2 oz. Crystal Salt/Pepper
H 3 3/8" | D 1 5/8"
3 doz. | 7 lbs. | 0.25 cu. ft.



16U
2 oz. Salt/Pepper
H 4 1/4" | D 2 1/8"
2 doz. | 11 lbs. | 0.25 cu. ft.



80570
2 oz. Continenta Salt/Pepper
H 4 1/4" | D 2 1/8"
2 doz. | 11 lbs. | 0.25 cu. ft.



90079
2 oz. Square Salt/Pepper
H 3 3/8" | D 1 5/8"
2 doz. | 9 lbs. | 0.18 cu. ft.



6099U
1 oz. Tower Salt/Pepper
H 4 1/2" | D 2"
2 doz. | 8 lbs. | 0.32 cu. ft.



39122
3 1/4 oz. Swirl Salt/Pepper
H 3 3/8" | D 1 5/8"
1 doz. | 2 lbs. | .13 cu. ft.

Votives



99005
12 oz. Flared Square
H 4" | D 3 1/4"
1/2 doz. | 5 lbs. | 0.80 cu. ft.



99006
5 oz. Flared Square
H 3" | D 2 1/4"
1/2 doz. | 3.5 lbs. | 0.15 cu. ft.



3354KR1
Ivy Ball
H 3 7/8" | D 4"
1 doz. | 6 lbs. | 0.57 cu. ft.



3355DHR1
Footed Ivy Ball
H 5 3/8" | D 4 3/4"
1 doz. | 6 lbs. | 0.57 cu. ft.

Ashtrays



143U
3 5/8" Square
H 3 3/4" | D 3 5/8"
3 doz. | 21 lbs. | 0.46 cu. ft.



148U
4 3/8" Round Snuffer
H 1 1/8" | D 4 3/8"
3 doz. | 21 lbs. | 0.66 cu. ft.



44912
5 3/4" Executive
N/A" | D 3 3/4"
1/2 doz. | 12 lbs. | 0.29 cu. ft.



72U
5" Safety Stacking Ashtray
H 3/4" | D 5"
1/2 doz. | 12 lbs. | 0.29 cu. ft.

Care & Handling

Mechanical Shock: When glassware comes in sudden contact with any hard surface or object, whether it's another glass, the countertop, or a beer tap, small abrasions are created which weaken the surface and increase the chance of breakage and chipping.

Never stack glasses. Avoid glass to glass contact in all instances

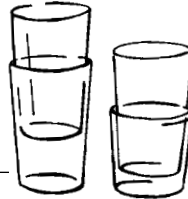

Do not use glassware for storage of flatware.



Separate glassware, flatware and china in bus trays.



Never pick up glasses in bouquets.

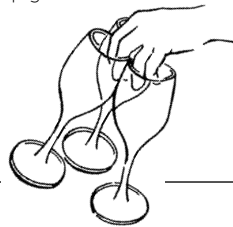

Never pour cold liquid into a hot glass, such as one just out of the dishwasher, or hot liquid into a cold glass.



Never scoop ice with a glass. Use a plastic scoop.



Empty ice from glass before sorting bus tray, this allows more time for the glass to reach room temperature before washing.

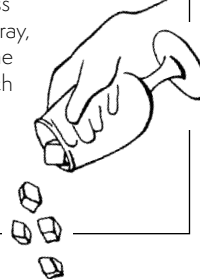

Keep an adequate backup supply of glasses. A recently washed glass should be allowed to reach room temperature before being placed back in service.

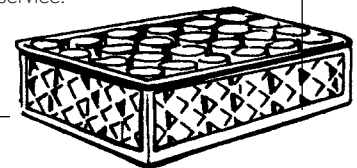

Utilize the correct rack system for tumblers and stems. A divided rack is always recommended.

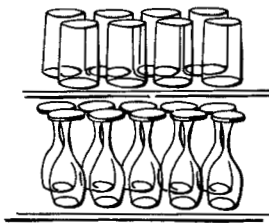

Thermal Shock: The result of a rapid temperature change in the glassware which can create stress and/or cracking.

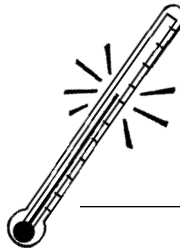

Tools of the Trade

Service Setting

An adequate inventory of glassware in a foodservice operation or bar will help decrease breakage, because if supplies are short, workers must handle glasses faster and less carefully. These charts offer not hard-and-fast rules, but only suggested requirements.

Custom Capabilities

In addition to our expansive foodservice product line, Anchor Hocking offers a full range of value-added solutions to meet your individual needs. Choose from customized products that are unique to your company or special packaging that can help build your brand name. Our goal is to provide not only quality glassware to our customers, but quality solutions.

Silk Screen Decorating Product Modifications

Promote your company logo through a durable lead-free silk-screen decoration. Available in one to five colors.

Create new, unique items built around your company name or logo.

Unique Decorating

Add color to any existing glassware item to create a bold impression.

Custom Packaging

Develop unique cartons to fit your specific pack, material, and label requirements.

Glassware Requirements

Sample Bar Glassware Requirements

(per 100 seats)

Item	Capacity	Bar	Rest. Bar
Beer	6 - 12 oz.	12 dz.	12 dz.
Champagne	3.5 - 3 oz.	3 dz.	3 dz.
Cocktail	3 - 6 oz.	9 dz.	6 dz.
Hi-Ball	7 - 11 oz.	12 dz.	9 dz.
Wine	6.5 - 9 oz.	6 dz.	9 dz.
Sours	5 - 6 oz.	3 dz.	3 dz.
Rocks	4 - 7 oz.	9 dz.	6 dz.
Cordials	.75 - .5 oz.	3 dz.	3 dz.
Collins	9 - 12 oz.	3 dz.	3 dz.
Brandy	5.5 - 34 oz.	3 dz.	3 dz.

Sample Foodservice Glassware Requirements

(per 100 seats)

Item	Coffee Shop	Dining Room	Banquet
Juice Glasses	24 dz.	12 dz.	12 dz.
Water Glasses	36 dz.		
Iced Tea Glasses	24 dz.	12 dz.	12 dz.
Water Goblets		24 dz.	18 dz.
Sherbet Glasses		12 dz.	12 dz.
Fruit Cocktail Glasses		12 dz.	12 dz.
Champagne Glasses			12 dz.
Parfait Glasses		12 dz.	12 dz.



Our Promise to You

Longer Life, Lower Replacement Costs

Anchor Hocking foodservice products are made stronger, more durable by special manufacturing processes:

RIM-TEMPERED products (sometimes referred to as heat treated) are similar to fully-tempered, except that the heat is concentrated on the rim area, followed by the cooling process, allowing for a stronger more durable product.

SureGuard™ Guarantee

Most Extensive Guarantee in the Industry

Anchor Hocking guarantees its entire foodservice line against chipping. If the rim of a tumbler or the foot or rim of a piece of stemware chips in normal use, Anchor Hocking will replace the item or refund the purchase price when returned to the dealer or distributor from whom it was purchased. Products in the foodservice line are defined as all active products in the foodservice price list. Naturally, this guarantee does not cover breakage.

World Headquarters

200 Civic Center Drive
Suite 700
Columbus, OH 43215
USA

Customer Service

Phone: 1.800.828.7033

International: InternationalCS@theoneidagroup.com

foodservice.oneida.com

ONEIDA®
Designing the dining experience.™

All pattern names and designs are intellectual properties of Oneida, Ltd., a subsidiary of The Oneida Group Inc.
Oneida® is a registered trademark of Oneida, Ltd. in the U.S. and certain countries.
200 S. Civic Center Drive, Suite 700, Columbus, OH 43215. ©2018 Oneida, Ltd. All rights reserved.

Anchor Hocking® and the Anchor Hocking logo are registered trademarks of
Anchor Hocking, LLC, a subsidiary of The Oneida Group Inc. in the U.S. and certain countries.
200 S. Civic Center Drive, Suite 700, Columbus, OH 43215. ©2018 Anchor Hocking, LLC. All rights reserved.