

**NEW PRODUCT
INTRODUCTIONS
MARCH, 2017**

PRODUCT INFORMATION

Hi-Pro LED wall pack series

High lumen, directional lamps for industrial and commercial fixture applications

Applications / Features

- For use in wall pack, canopy, shoe box, or cobra head fixtures
- 20/30/40 Watt options replaces 100/150/175 Watt HID
- Replaces HID
- Approved for totally enclosed fixtures
- Direct wire range voltage 100-277V
- IP64, higher efficiency, improved heat dissipation
- 2 CCT options
- 180° beam/adjustable base (E26/E39)
- Horizontal operation
- 5 Year limited warranty

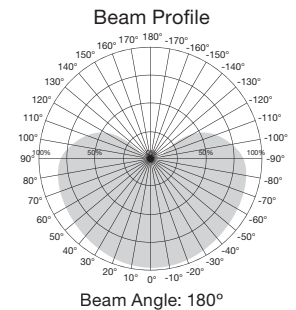

High Lumen Industrial/Commercial LED Lamps

Item Number	Lamp Description	W	V	Rpl.	Base Type	CCT	Lm	Bm	M.O.L. (Inches)	Life/Hrs.	UPC	Pack
S8904	20W/LED/HID/WP/3K/E26/100-277V	20	100-277	100W	E26	3000K	2700	180°	7 1/8	50K	045923089046	12
S8905	20W/LED/HID/WP/5K/E26/100-277V	20	100-277	100W	E26	5000K	2700	180°	7 1/8	50K	045923089053	12
S8906	30W/LED/HID/WP/3K/E26/100-277V	30	100-277	150W	E26	3000K	4050	180°	8 1/8	50K	045923089060	12
S8907	30W/LED/HID/WP/5K/E26/100-277V	30	100-277	150W	E26	5000K	4050	180°	8 1/8	50K	045923089077	12
S8908*	30W/LED/HID/WP/3K/E39/100-277V	30	100-277	150W	E39	3000K	4050	180°	8 11/16	50K	045923089084	12
S8909*	30W/LED/HID/WP/5K/E39/100-277V	30	100-277	150W	E39	5000K	4050	180°	8 11/16	50K	045923089091	12
S8924	40W/LED/HID/WP/3K/E26/100-277V	40	100-277	175W	E26	3000K	5400	180°	9 7/8	50K	045923089244	12
S8925	40W/LED/HID/WP/5K/E26/100-277V	40	100-277	175W	E26	5000K	5400	180°	9 7/8	50K	045923089251	12
S8926*	40W/LED/HID/WP/3K/E39/100-277V	40	100-277	175W	E39	3000K	5400	180°	10 5/8	50K	045923089268	12
S8927*	40W/LED/HID/WP/5K/E39/100-277V	40	100-277	175W	E39	5000K	5400	180°	10 5/8	50K	045923089275	12



PRODUCT INFORMATION

Hi-Pro LED shoe box lamp series

High lumen, directional lamps for industrial and commercial fixture applications

Applications / Features

- For use in shoe box fixtures
- 80/110 Watt options (10,000/14,000 lm) replaces 250/400 Watt HID
- Replaces HID
- Approved for totally enclosed fixtures
- Damp location
- Direct wire range voltage 100-277V
- Higher efficiency, improved heat dissipation
- 2 CCT options
- Expandable 180° beam design w/adjustable base (E39)
- Horizontal operation
- 5 Year limited warranty

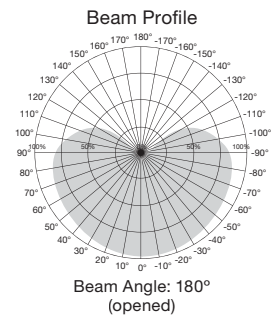
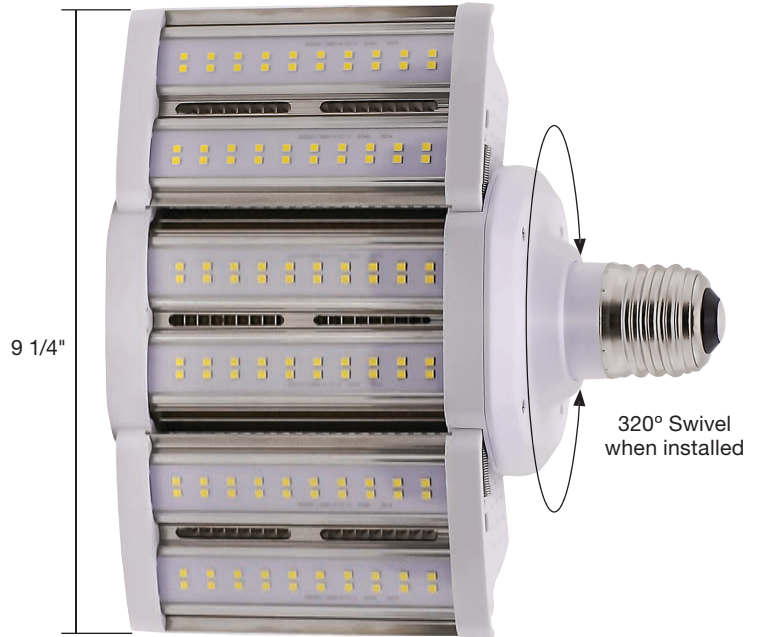

High Lumen Industrial/Commercial LED Lamps



Item Number	Lamp Description	W	V	Rpl.	Base Type	CCT	Lm	Bm	M.O.L. (Inches)	Life/Hrs.	UPC	Pack
S8931	80W/LED/HID/SB/3K/E39/100-277V	80	100-277	250W	E39	3000K	10000	180°	8 1/16	50K	045923089312	4
S8932	80W/LED/HID/SB/5K/E39/100-277V	80	100-277	250W	E39	5000K	10000	180°	8 1/16	50K	045923089329	4
S8937	110W/LED/HID/SB/3K/E39/100-277V	110	100-277	400W	E39	3000K	14000	180°	11 1/8	50K	045923089374	4
S8938	110W/LED/HID/SB/5K/E39/100-277V	110	100-277	400W	E39	5000K	14000	180°	11 1/8	50K	045923089381	4

NEW PRODUCT INFORMATION

4" LED direct wire downlights

Applications

- Residential
- Office
- Retail
- Hospitality
- Drop ceilings
- Remodeling

Highlights

- Easy install spring clips
- IC rated
- Low profile
- No recessed can required

Features

- Direct replacement for 45 Watt reflector lamps uses only 7 Watts
- Integrated j-box for direct wire installation saves time and materials
- Dimmable**
- Long life—40,000 hours
- c-UL-us classified
- Wet location
- 5 year warranty***
- ENERGY STAR® certified*

Available January, 2017

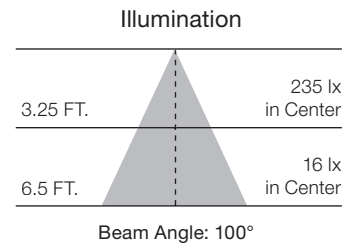

4" LED Direct Wire Downlights



Item Number	Lamp Description	W	V	CRI	CCT	Lm	Bm	M.O.L. (Inches)	Life/Hrs.	UPC
S9011*	7WLED/DW/RDL/4/27K/120V	7	120	83	2700K	550	100°	3 ¼	40K	045923090110
S9012*	7WLED/DW/RDL/4/30K/120V	7	120	83	3000K	550	100°	3 ¼	40K	045923090127
S9013*	7WLED/DW/RDL/4/40K/120V	7	120	83	4000K	550	100°	3 ¼	40K	045923090134

**Consult Satco or visit www.satco.com for an up to date dimmer compatibility list.
***See separate warranty for complete terms and conditions.

Pack: Master 12/1



NEW PRODUCT INFORMATION

5"/6" LED direct wire downlights

Applications

- Residential
- Office
- Retail
- Hospitality
- Drop ceilings
- Remodeling

Highlights

- Easy install spring clips
- IC rated
- Low profile
- No recessed can required

Features

- Direct replacement for 65 Watt reflector lamps uses only 9 Watts
- Integrated j-box for direct wire installation saves time and materials
- Dimmable**
- Long life—40,000 hours
- c-UL-us classified
- Wet location
- 5 year warranty***
- ENERGY STAR® certified*

Available January, 2017

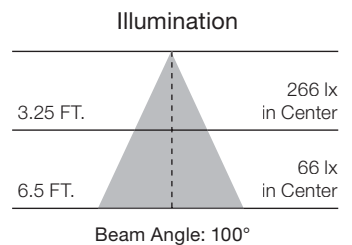

5"/6" LED Direct Wire Downlights



Item Number	Lamp Description	W	V	CRI	CCT	Lm	Bm	M.O.L. (Inches)	Life/Hrs.	UPC
S9026*	9WLED/DW/RDL/5-6/27K/120V	9	120	83	2700K	700	100°	3 5/8	40K	045923090264
S9027*	9WLED/DW/RDL/5-6/30K/120V	9	120	83	3000K	700	100°	3 5/8	40K	045923090271
S9028*	9WLED/DW/RDL/5-6/40K/120V	9	120	83	4000K	700	100°	3 5/8	40K	045923090288

**Consult Satco or visit www.satco.com for an up to date dimmer compatibility list.
***See separate warranty for complete terms and conditions.

Pack: Master 12/1



NEW PRODUCT INFORMATION

4" LED direct wire edge-lit downlights

Applications

- Residential
- Office
- Retail
- Hospitality
- Drop ceilings
- Remodeling

Highlights

- Easy install spring clips
- IC rated
- Low profile
- No recessed can required

Features

- Direct replacement for 45 Watt reflector lamps uses only 8.5 Watts
- Edge lit technology
- Slim design
- Integrated j-box for direct wire installation saves time and materials
- Dimmable*
- Long life—40,000 hours
- c-UL-us classified
- Damp location
- 5 year warranty**

Available January 2017



Top view

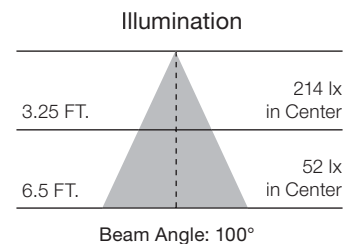

4" LED Direct Wire Edge-Lit Downlights

Item Number	Lamp Description	W	V	CRI	CCT	Lm	Bm	M.O.L. (Inches)	Life/Hrs.	UPC
S9055	8.5WLED/DW/EL/4/27K/120V	8.5	120	83	2700K	500	100°	1 3/4	40K	045923090554
S9056	8.5WLED/DW/EL/4/30K/120V	8.5	120	83	3000K	500	100°	1 3/4	40K	045923090561
S9057	8.5WLED/DW/EL/4/40K/120V	8.5	120	83	4000K	500	100°	1 3/4	40K	045923090578

*Consult Satco or visit www.satco.com for an up to date dimmer compatibility list.
**See separate warranty for complete terms and conditions.

Pack: Master 12/1



NEW PRODUCT INFORMATION

5"/6" LED direct wire edge-lit downlights

Applications

- Residential
- Office
- Retail
- Hospitality
- Drop ceilings
- Remodeling

Highlights

- Easy install spring clips
- IC rated
- Low profile
- No recessed can required

Features

- Direct replacement for 65 Watt reflector lamps uses only 11.6 Watts
- Edge lit technology
- Slim design
- Integrated j-box for direct wire installation saves time and materials
- Dimmable*
- Long life—40,000 hours
- c-UL-us classified
- Damp location
- 5 year warranty**

Available January, 2017



Top view

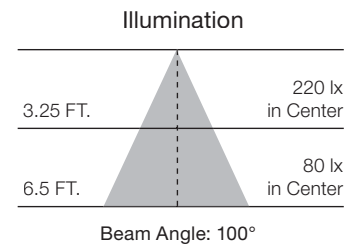

5"/6" LED Direct Wire Edge-Lit Downlights



Item Number	Lamp Description	W	V	CRI	CCT	Lm	Bm	M.O.L. (Inches)	Life/Hrs.	UPC
S9061	11.6WLED/DW/EL/5-6/27K/120V	11.6	120	83	2700K	800	100°	1 ¾	40K	045923090615
S9062	11.6WLED/DW/EL/5-6/30K/120V	11.6	120	83	3000K	800	100°	1 ¾	40K	045923090622
S9063	11.6WLED/DW/EL/5-6/40K/120V	11.6	120	83	4000K	800	100°	1 ¾	40K	045923090639

*Consult Satco or visit www.satco.com for an up to date dimmer compatibility list.

**See separate warranty for complete terms and conditions.

Pack: Master 12/1

NEW PRODUCT INFORMATION

4" LED square trim recessed downlight retrofits

Applications

- Residential
- Office
- Retail
- Hospitality

Features

- 45 Watt replacement uses only 10 Watts
- Direct replacement for reflector lamps
- Dimmable**
- Long life—50,000 hours
- Durable die-cast finish
- c-UL-us classified
- Wet location
- 5 year warranty
- ENERGY STAR® certified

E26 Adapter included 

GU10 Adapter sold separately

Available February 2017

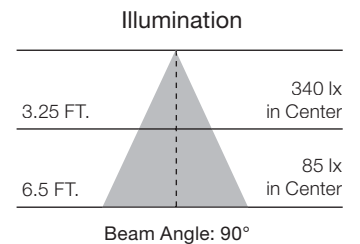

4" LED Square Trim Recessed Downlight Retrofits



Item Number	Lamp Description	W	V	CRI	CCT	Lm	Bm	M.O.L. (Inches)	Life/Hrs.	UPC
S9756*	10WLED/4/SQ/27K/120V	10	120	90	2700K	600	90°	4	50K	045923097560
S9757*	10WLED/4/SQ/30K/120V	10	120	90	3000K	600	90°	4	50K	045923097577
S9758*	10WLED/4/SQ/40K/120V	10	120	90	4000K	600	90°	4	50K	045923097584
S9759*	10WLED/4/SQ/50K/120V	10	120	90	5000K	600	90°	4	50K	045923097591

* ENERGY STAR pending - February 2017

** Consult Satco or visit www.satco.com for an up to date dimmer compatibility list.

Pack: Master 24/1



NEW PRODUCT INFORMATION

5"/6" LED square trim recessed downlight retrofits

Applications

- Residential
- Office
- Retail
- Hospitality

Features

- Up to 85 Watt replacement uses only 16 Watts
- Direct replacement for reflector lamps
- Dimmable**
- Long life—50,000 hours
- Durable die-cast finish
- c-UL-us classified
- Wet location
- 5 year warranty
- ENERGY STAR® certified

Available February 2017

E26 Adapter included 

GU24 Adapter sold separately

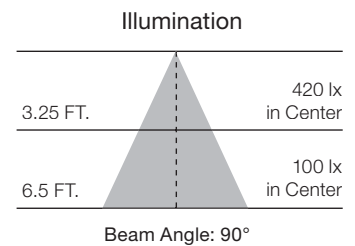

5"/6" LED Square Trim Recessed Downlight Retrofits



Item Number	Lamp Description	W	V	CRI	CCT	Lm	Bm	M.O.L. (Inches)	Life/Hrs.	UPC
S9770*	16WLED/5-6/SQ/27K/120V	16	120	90	2700K	1000	90°	5-6	50K	045923097706
S9771*	16WLED/5-6/SQ/30K/120V	16	120	90	3000K	1000	90°	5-6	50K	045923097713
S9772*	16WLED/5-6/SQ/40K/120V	16	120	90	4000K	1000	90°	5-6	50K	045923097720
S9773*	16WLED/5-6/SQ/50K/120V	16	120	90	5000K	1000	90°	5-6	50K	045923097737

* ENERGY STAR pending - February 2017

** Consult Satco or visit www.satco.com for an up to date dimmer compatibility list.

Pack: Master 12/1

NEW PRODUCT INFORMATION

6" Commercial LED recessed downlight retrofits

Applications

- Office
- Retail
- Hospitality
- Manufacturing

Features

- Replace up to 2 x 18W CFLs per fixture
- External driver for simple retrofitting
- Quick connect feature for easy installation
- 120-277 range voltage circuit
- 0-10V dimming
- 90CRI
- Wet location
- c-UL-us Classified
- ENERGY STAR certified*



Installs into existing frame-in kit.

Set of 3 retaining clips included.



6" Commercial LED Recessed Downlight Retrofits



Item Number	Lamp Description	W	V	CRI	CCT	Lm	Bm	M.O.L. (Inches)	Life/Hrs.	UPC
S9794*	20WLED/CDL/6/30K/120-277V	20	120-277	90	3000K	1500	40°	6	50K	045923097942
S9795*	30WLED/CDL/6/30K/120-277V	30	120-277	90	3000K	2000	40°	6	50K	045923097959

*ENERGY STAR pending April 2017

Pack: Master 8/1



NEW PRODUCT INFORMATION

8" Commercial LED recessed downlight retrofits

Applications

- Office
- Retail
- Hospitality
- Manufacturing

Features

- Replace up to 2 x 26W CFLs per fixture
- External driver for simple retrofitting
- Quick connect feature for easy installation
- 120-277 range voltage circuit
- 0-10V dimming
- 90CRI
- Wet location
- c-UL-us Classified
- ENERGY STAR certified*



Installs into existing frame-in kit.

Set of 3 retaining clips included.



8" Commercial LED Recessed Downlight Retrofits



Item Number	Lamp Description	W	V	CRI	CCT	Lm	Bm	M.O.L. (Inches)	Life/Hrs.	UPC
S9796*	20WLED/CDL/8/30K/120-277V	20	120-277	90	3000K	1500	40°	8	50K	045923097966
S9797*	30WLED/CDL/8/30K/120-277V	30	120-277	90	3000K	2000	40°	8	50K	045923097973

*ENERGY STAR pending April 2017

Pack: Master 4/1

PRODUCT INFORMATION

Smart home gear: 86-103 In-Wall Dimmer*

Features

- Works with incandescent and most dimmable fluorescent (CFL), or LED lighting
- 7 LEDs to indicate ON/OFF/Dimming level status
- Fits standard wall plate (not included)
- Z-Wave Plus Certified
- GROUP/ALL enabled, if supported by controller
- Multiple scene control using double and triple tap
- Provides instant manual status change to controller
- Supports Central Scene command class
- Over-The-Air firmware upgrade available, if supported by controller
- Supports Network Wide Inclusion (inclusion through a repeater), if supported by controller
- Powered by Sigma Design 500 Series module inside
- Functions as a Z-Wave signal repeater
- Supports screw and wire terminals



General

Parameter	
Operating Temperature	32° F to 104° F
Storage Temperature	-4° F to 140° F
Storage Humidity	80%
Electrical Ratings	
Input Voltage	120 VAC RMS
Input Frequency	60Hz
Maximum Output Load	Incandescent (600W, single gang), Dimmable CFL/LED (150W)
Wire Terminals	Requires neutral
Fuse	10A
Z-Wave Frequency for USA and Canada	908.4Mhz at 40kps, 916Mhz at 100kps
Wireless Range (controller & repeater)	130 ft. at open air, 1 meter high, LOS
Modulation	FSK/GFSK
Tx Power from IC setting	2 dbm
Rx Sensitivity at 40 kps	-99 dbm
Rx Sensitivity at 100 kps	-91.8 dbm
Standby Current	25mA

* Need ZWAVE compatible controller

Mechanical Parameters

Dimensions	Body:2.8"x1.71"x1.41" Yoke: 4.13"x2.13"x.076"
Wire Terminals	Line, Load, Ground, Traveler, Neutral
Minimum Hole for Wire	Accepts #12 AWG (0.081" dia) Doesn't Accept #8 AWG (0.1285" dia)
Wire Type	Copper or plated aluminum
Clamp Parts	Copper only
Wire Binding Screws	UL 486a/b: Minimum Dia=#6(.138) Max Threads/inch = 36
Color	Munsell N9 Apple White
Material	PC, Type 6485

Supplied Parts

Description	Quantity
86-103 In-Wall Dimmer	1
Mounting Screws	2
Instruction Manual	1



Smart home gear: 86-102 In-Wall Light Switch*

Features

- Works with incandescent lamps, fluorescent (CFL), and LED lighting
- Fits standard wall plate (not included)
- Z-Wave Plus Certified
- Clean design with white LED status indicator
- GROUP/ALL enabled, if supported by controller
- Multiple scene control using double and triple tap
- Provides instant manual status change to controller
- Supports Central Scene command class
- Over-The-Air firmware upgrade available, if supported by controller
- Supports Network Wide Inclusion (inclusion through a repeater), if supported by controller
- Powered by Sigma Design 500 Series module inside
- Functions as a Z-Wave signal repeater
- Supports screw and wire terminals

PRODUCT INFORMATION



General

Parameter	
Operating Temperature	32° F to 104° F
Storage Temperature	-4° F to 140° F
Storage Humidity	80%
Electrical Ratings	
Input Voltage	120 VAC RMS
Input Frequency	60Hz
Wire Terminals	Requires neutral
Maximum Output Load	900W incandescent, 200W CFL/LED, ½ horsepower motor and 15A, 1800W resistive load
Fuse	0.5A
Z-Wave Frequency for USA and Canada	908.4Mhz at 40kps, 916Mhz at 100kps
Wireless Range (controller & repeater)	130 ft. at open air, 1 meter high, LOS
Modulation	FSK/GFSK
Tx Power from IC setting	2 dbm
Rx Sensitivity at 40 kps	-99 dbm
Rx Sensitivity at 100 kps	-91.8 dbm
Standby Current	25mA

* Need ZWAVE compatible controller

Mechanical Parameters

Dimensions	Body:2.8"x1.71"x1.41" Yoke: 4.13"x2.13"x.076"
Minimum Hole for Wire	Accepts #12 AWG (0.081" dia) Doesn't Accept #8 AWG (0.1285"dia)
Wire Type	Copper or plated aluminum
Clamp Parts	Copper only
Wire Binding Screws	UL 486a/b: Minimum Dia=#6(.138) Max Threads/inch = 36
Color	Munsell N9 Apple White
Material	PC, Type 6485

Supplied Parts

Description	Quantity
86-102 In-Wall Light Switch	1
Mounting Screws	2
Instruction Manual	1



PRODUCT INFORMATION

Smart home gear: 86-104 3-Way Auxiliary Switch*

Features

- 3 way switch that works with Satco 86-102 wall switch or 86-103 wall dimmer
- Fits standard wall plate (not included)
- Reliable and affordable way to add 3 way or 4 way switch
- Up to 3 86-104 auxiliary switches (5 way) can be used with one Satco in wall switch or dimmer
- Connects and controls through traveler wire
- When used with Satco 86-103 dimmer, 86-104 can also be used to control dimming
- Multiple scene control using double and triple tap
- Provides instant manual status change to controller
- Supports Central Scene command class
- Supports screw and wire terminals



General

Parameter	
Operating Temperature	32° F to 104° F
Storage Temperature	-4° F to 140° F
Storage Humidity	80%
Mechanical Parameters	
Dimensions	Body: 2.8"x1.71"x1.41" Yoke: 4.13"x2.13"x.076"
Wire Terminals	Traveler, Neutral, Ground. Requires neutral and traveler wire
Minimum Hole for Wire	Accepts #12 AWG (0.081" dia) Doesn't Accept #8 AWG (0.1285" dia)
Wire Type	Copper only
Clamp Parts	Copper or plated aluminum
Wire Binding Screws	UL 486a/b: Minimum Dia=#6(.138) Max Threads/inch = 36
Color	Munsell N9 Apple White
Material	PC, Type 6485

Supplied Parts	
Description	Quantity
86-104 3 Way Auxiliary Switch	1
Mounting Screws	2
Instruction Manual	1

* Need ZWAVE compatible controller



PRODUCT INFORMATION

Smart home gear: 86-101 Plug-In Dimmer Module*

Features

- Works with incandescent and most dimmable fluorescent (CFL), or LED lighting
- LED backlit Key for manual ON/OFF and status indicator
- GROUP/SCENE/ALL enabled, if supported by controller
- Over-The-Air firmware upgrade available, if supported by controller
- Supports Network Wide Inclusion (inclusion through a repeater), if supported by controller
- Powered by Sigma Design 500 Series module inside
- Compact design - does not block the 2nd AC outlet
- Functions as Z-Wave repeater



General

Parameter	
Operating Temperature	32° F to 104° F
Storage Temperature	-4° F to 140° F
Storage Humidity	80%
Electrical Ratings	
Input Voltage	120 VAC RMS
Input Frequency	60Hz
Maximum Output Load	Incandescent 300W (2.5A), Dimmable CFL/LED 65W Fuse 5A
Fuse	5A
Dimmer conduction angle	90% at max fully on position
Z-Wave Frequency for USA and Canada	908.4Mhz at 40kps, 916Mhz at 100kps
Wireless Range (controller & repeater)	130 ft. at open air, 1 meter high, LOS
Modulation	FSK/GFSK
Tx Power from IC setting	2 dbm
Rx Sensitivity at 40 kps	-99 dbm
Rx Sensitivity at 100 kps	-91.8 dbm

* Need ZWAVE compatible controller

Mechanical Parameters	
Dimensions	Body: L3.27" X W2.13" X H1.5"
With plug:	L3.27" X W2.13" X H1.5"
Color	Munsell N9 Apple White
Material	PC, Type 6485

Supplied Parts	
Description	Quantity
86-101 Plug-In Dimmer Module 1	1
Instruction Manual	1



PRODUCT INFORMATION

Smart home gear: 86-100 Plug-In Appliance Module*

Features

- Turns ON/OFF incandescent, CFL, or LED lamps, and AC operated electrical appliances
- LED backlit Key for manual ON/OFF and status indicator
- Z-Wave Plus Certified
- Controls appliances up to 15A
- Functions as Z-Wave signal repeater
- Grounded 3-pin AC power receptacle to enhance safety
- Compact design - does not block the 2nd AC outlet
- Over-The-Air firmware upgrade available, if supported by controller
- Supports Network Wide Inclusion (inclusion through a repeater), if supported by controller
- Powered by Sigma Design 500 Series module inside



General

Parameter	
Operating Temperature	32° F to 104° F
Storage Temperature	-4° F to 140° F
Storage Humidity	80%
Electrical Ratings	
Input Voltage	120 VAC RMS
Input Frequency	60Hz
Maximum Output Load	900W incandescent, 200W CFL/LED, ½ horsepower motor and 15A, 1800W resistive load
Fuse	0.5A
Z-Wave Frequency for USA and Canada	908.4Mhz at 40kps, 916Mhz at 100kps
Wireless Range (controller & repeater)	130 ft. at open air, 1 meter high, LOS
Modulation	FSK/GFSK
Tx Power from IC setting	2 dbm
Rx Sensitivity at 40 kps	-99 dbm
Rx Sensitivity at 100 kps	-91.8 dbm

* Need ZWAVE compatible controller

Mechanical Parameters	
Dimensions	Body: L3.27" X W2.13" X H1.5"
With plug:	L3.27" X W2.13" X H2.32"
Color	Munsell N9 Apple White
Material	PC, Type 6485

Supplied Parts	
Description	Quantity
86-100 Plug-In Appliance Module	1
Instruction Manual	1



PRODUCT INFORMATION

Circular LED module retrofit kits

Upgrades most flushmount fixtures to efficient LED light

Features

- Replaces 3 60W incandescent lamps, uses only 20 Watts
- Dimmable
- Dimensions: 8" W x 0.65" H
- Life—30,000 hours
- 3 Year warranty

Kit Contains

- LED Circular light engine
- All necessary hardware for installation into a variety of flushmount fixtures
- Instructions and wiring diagrams

- A) (1) circular light engine
 B) (6) small wire nuts
 C) (6) medium wire nuts
 D) (1) lock-down retaining ring & washer
 E) (3) 1" #4 screws
 F) (4 x 2 each) assorted snap-in grommets (install grommets where supply wires enter fixture for power).
 G) Wiring Diagram

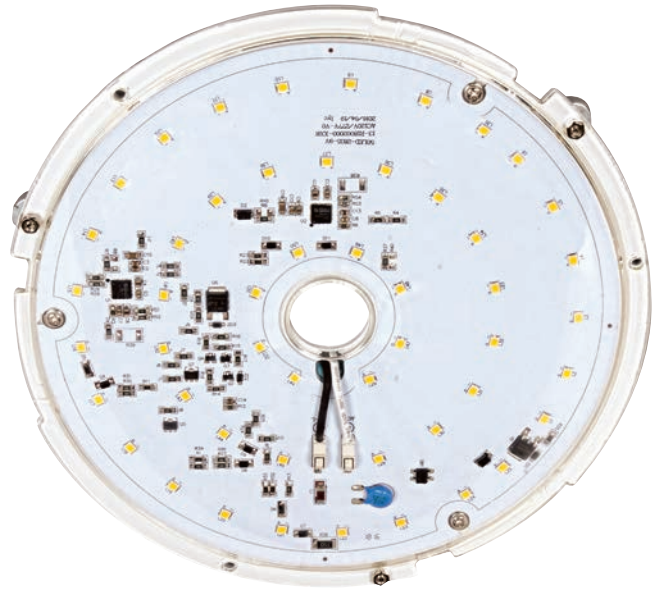

Easily converts most standard flushmount fixtures to LED



Circular LED Module Retrofit Kits



Item Number	Lamp Description	W	V	CCT	CRI	Lm	Life/Hrs.	UPC
S9782	20W/LED/LIGHT ENGINE/27K/RK	20	120-277	2700K	90	1450	30K	045923097829
S9783	20W/LED/LIGHT ENGINE/30K/RK	20	120-277	3000K	90	1550	30K	045923097836
S9784	20W/LED/LIGHT ENGINE/40K/RK	20	120-277	4000K	90	1650	30K	045923097843



PRODUCT INFORMATION

Hi-Pro LED temporary hi-bay caged lamp series

High lumen, omni-directional lamps for industrial and commercial applications

Applications / Features

- For use in any commercial work area
- 60/80 Watt options (7200/9600 lm)
- Includes 3' power cord/plug and hook for easy installation
- Replaces HID, CFL, and Incandescent
- Direct wire 120V
- Approved for totally enclosed fixtures
- IP64, higher efficiency, improved heat dissipation
- 360° Omni-directional light
- 5 Year limited warranty

Available February 2017

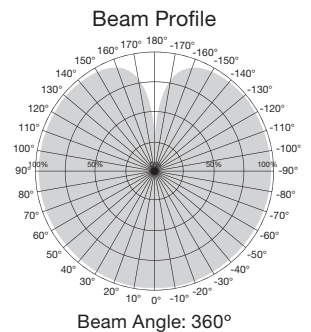

High Lumen Industrial/Commercial LED Lamps

Item Number	Lamp Description	W	V	Rpl.	Base Type	CCT	Lm	Bm	M.O.L. (Inches)	Life/Hrs.	UPC	Pack
S8939	60W/LED/HID/TEMP/5000K/100-277V	60	120V	200W	Hook/Plug	5000K	7200	360°	13 ½	50K	045923089398	4
S8940	80W/LED/HID/TEMP/5000K/100-277V	80	120V	250W	Hook/Plug	5000K	9600	360°	13 ½	50K	045923089404	4

UNIVERSAL LAMP DISPLAY

An exciting display to help sell great Satco LED products.

- Display a number of LED products with matching descriptive graphics
- It's small footprint (less than 1 square foot) uses little counter space but tells the complete product story
- Measures only 20-3/4" H x 11-3/4" D x 9-3/8" W
- Mogul to medium base adapter included

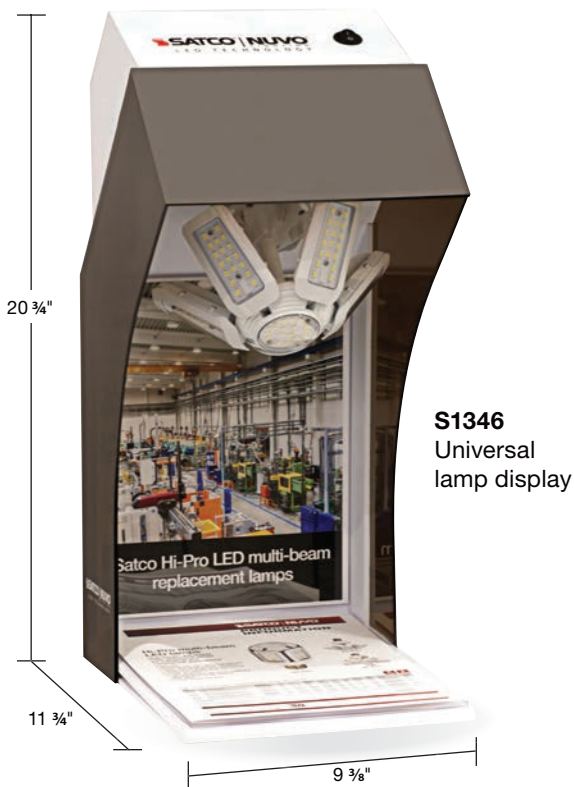

Minimum purchase required for free display—\$500

Interchangeable display graphics—must be ordered separately.

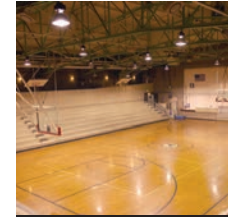

Satco Hi-Pro LED HID replacement lamps

Hi-Pro LED replacement lamps
S1235



Satco Hi-Pro LED multi-beam replacement lamps

Hi-Pro LED multi-beam lamps
S1236



Satco Hi-Pro LED high lumen PAR lamps

Hi-Pro LED high Lumen PAR lamps
S1234



Satco Hi-Pro LED power flood HID replacement lamps

Hi-Pro LED power flood lamps
S1232

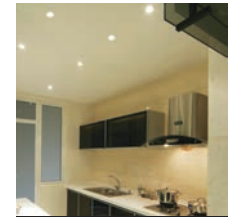

Satco quick trim LED downlight retrofits

Quick trim LED downlight retrofits
S1231

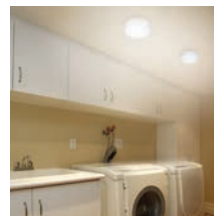

Nuvo Lighting LED utility fixture

LED utility fixture
S1230

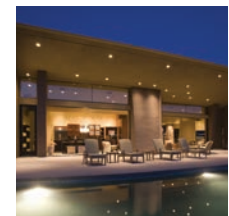

Satco LED PAR lamps

LED PAR lamps
S1233

PRODUCT INFORMATION

LED Flat panel fixtures

Even, consistent light.
Low maintenance.
High efficiency.

Applications / Features

- DLC 4.0 certified
- Maintenance free—no bulb to change
- Perfect, even light distribution
- CRI > 90
- Ultra-slim edge-lit design
- Lasts 50,000 hours of continuous use
- 0-10V dimming
- Universal input voltage—100-277V
- 3500K, 4000K and 5000K versions
- Suspended* or drop into T-bar grid
- Certified for damp locations
- 5 year warranty

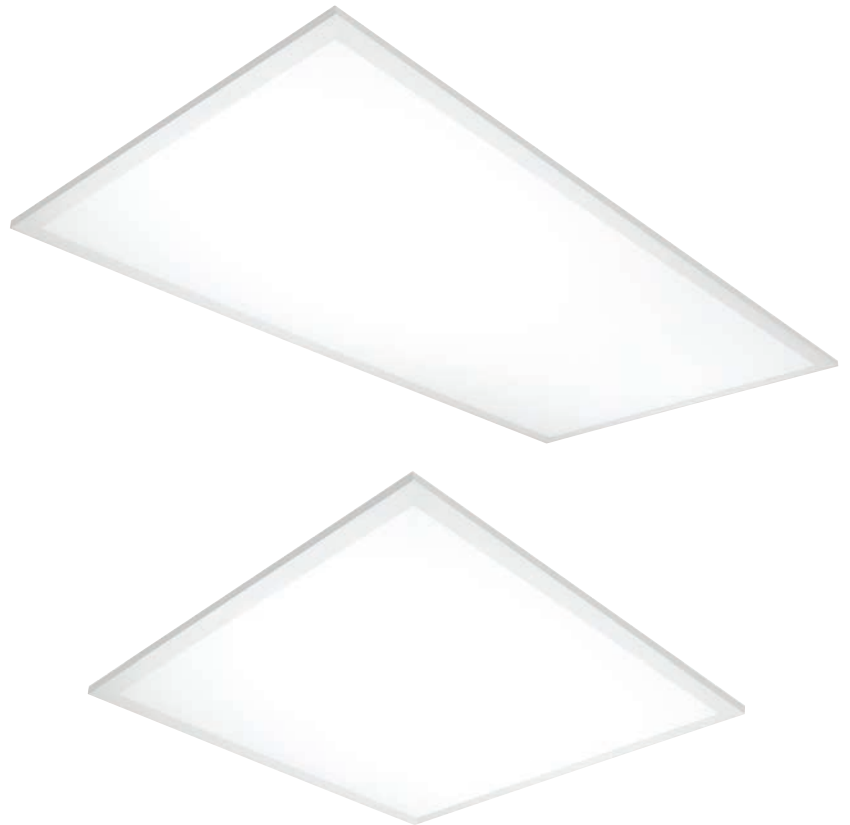

LED Flat Panel



Item Number	Lamp Description	W	Voltage	CRI	CCT	Lm	Efficiency (LM/W)	Life/ Hrs.	UPC	Pack
65/311	2FT X 2FT LED FLAT PANEL 37 WATT	37	100-277	90	3500K	3800	103	50K	045923643118	2
65/312	2FT X 2FT LED FLAT PANEL 37 WATT	37	100-277	90	4000K	3880	105	50K	045923643125	2
65/313	2FT X 2FT LED FLAT PANEL 37 WATT	37	100-277	90	5000K	3960	107	50K	045923643132	2
65/314	1FT X 4FT LED FLAT PANEL 37 WATT	37	100-277	90	3500K	3800	100	50K	045923643149	2
65/315	1FT X 4FT LED FLAT PANEL 37 WATT	37	100-277	90	4000K	3880	100	50K	045923643156	2
65/316	1FT X 4FT LED FLAT PANEL 37 WATT	37	100-277	90	5000K	3960	100	50K	045923643163	2
65/317	2FT X 4FT LED FLAT PANEL 48 WATT	48	100-277	90	3500K	5000	104	50K	045923643170	2
65/318	2FT X 4FT LED FLAT PANEL 48 WATT	48	100-277	90	4000K	5070	105	50K	045923643187	2
65/319	2FT X 4FT LED FLAT PANEL 48 WATT	48	100-277	90	5000K	5140	107	50K	045923643194	2

* Suspension kit sold separately.

Specifications

ITEM	SPECIFICATION	DETAILS
General Performance	Spacing Criteria	Available upon request
	Efficacy (LM/W)	100lm/w 100lm/w
	CRI	>90
	Color Consistency	Proprietary binning for uniform color
	Lumen Maint. (L70)	50,000 hours
Electrical	Power Factor	Over 95%
	Input Voltage	100V-277V 50/60 Hz
	Power Consumption	40&50 Watt nominal
Control	Dimming Switch	Standard 0-10V dimming 10%-100%
	Linking Lengths/Qty.	15 Cable Feet x 20 Panels
Physical	Dimensions	23.7" x 47.6" x 1.8"
	Weight	28.25 lbs.
	Housing	Aluminum
	Lens	Translucent white PS
	Mounting	Fits standard grid for drop ceilings
	Operating Temperature	-5°F to 104°F
	Humidity	20% - 85% RH, non condensing
Certification	Certification	cETLus, DLC, Fcc
	Material Usage	RoHS compliant; no mercury
	Environment	Damp location
	Warranty	Five year

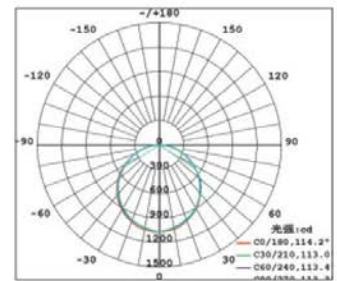
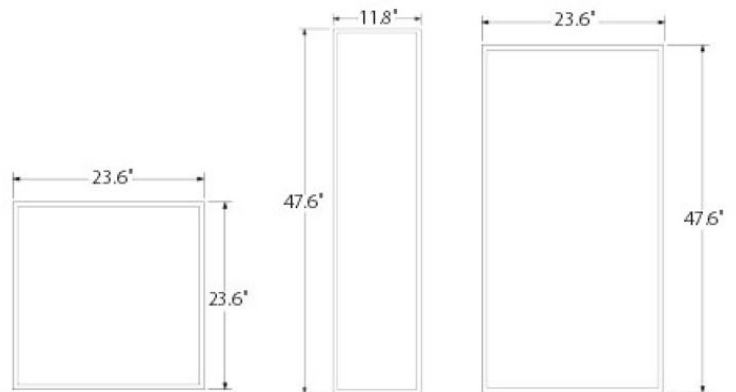

0-10V Dimmer Compatibility

Brand	Description	Model	Load Max	Poles	Performance Rating
Lutron	Diva 0-10V control (gloss finish), single pole, preset, 30mA sink, 16A load (needs Power Pack PP-DV)	DVTV (DIVA)	120-277 30mA/16A	Single	Best
Lutron	Diva 0-10V control (gloss finish), single pole/3-way, preset, 50mA sink, 8A load	DVSTV (DIVA)	120-277 50mA/8A	Single pole/3-way	Best
Lutron	Diva 0-10V control (satin finish), single pole, preset, 30mA sink, 16A load (needs Power Pack PP-DV)	DVSCSTV (DIVA)	120-277 30mA/16A	Single	Best
Lutron	Diva 0-10V control (Satin finish), single pole/3-way, preset, 50mA sink, 8A load	DVSCSTV (DIVA)	120-277 50mA/8A	Single pole/3-way	Best
Lutron	Maestro 0-10V Dimmer and Occupancy/Vacancy PIR Sensor, single pole/multi location	MSZ101-WH	120-277	Single pole/Multi	Better
Lutron	Skylark Fluorescent Preset Dimmer, 120V dimmers also LED compatible with GRX-TVI	SF-103P-WH	120VAC/8A	3-way	Better
Cooper	Dimmable LED/FLR0-10V ballasts, DEVINE Slide Dimmer, single pole/3-way, preset	DF10P	1200W 120V/60Hz 1600W 277V/60Hz	Single pole/3-way	Best
Cooper	Dimmable LED/FLR0-10V ballasts, SKYE Slide Dimmer, single pole/3-way, preset	SF10P	1200W 120V/60Hz 1600W 277V/60Hz	Single pole/3-way	Best
Leviton	Designed for use with LED fixtures Using 0-10V power supplier, No power pack req. for switching	DS710	120VAC/60Hz 277VAC/60Hz		Best
Leviton	LED Dimmer for 0-10V power suppliers, no LED locator	IP710-LF	1200VA@120VAC 1500VA@277VAC	Single/2Gang/ 3-Gang	Best
Leviton	Renoir II Rotary, Ballast 0-10V, Standard Heat Sink Dimmer, Linear dimming, Narrow, 16 A, White	WRMG-7DW	120-277VAC 60HZ/16A		Better
Leviton	1200VA Preset Fluorescent Slide Dimmer, Single Pole and 3-Way	IP710-DLX	1200VA, 120/277 Volt AC60Hz	Single pole/3-way	Better
Leviton	Renoir II Preset Slide Dimmer, Linear dimming, Ballast 0-10V, Thin Heat Sink, Narrow, 16A, White	AWSMT-7DW	120-277VAC, 60HZ/16A		Limited
Leviton	Fluorescent Renoir II Slide Preset Master Dimmer	AWSMG-7DW	0-277VAC, 60HZ/16A		Limited

PRODUCT INFORMATION

LED Troffer fixtures

Even, consistent light.
Low maintenance.
High efficiency.

Features

- DLC 4.0 certified
- Volumetric design
- Acrylic linear prismatic lens
- Maintenance free—no bulb to change
- Even light distribution
- CRI >90
- Lasts 50,000 hours of continuous use
- 0-10V dimming
- Universal input voltage, 100V-277V
- Drop into T-bar grid
- Certified for damp locations
- 5 Year warranty



LED Flat Panel



Item Number	Lamp Description	W	Voltage	CRI	CCT	Lm	Efficiency (LM/W)	Life/ Hrs.	UPC	Pack
65/301	2FT X 2FT LED TROFFER 32 WATT	32	100-277	90	3500K	3200	100	50K	045923643019	1
65/302	2FT X 2FT LED TROFFER 32 WATT	32	100-277	90	4000K	3300	104	50K	045923643026	1
65/303	2FT X 2FT LED TROFFER 32 WATT	32	100-277	90	5000K	3300	104	50K	045923643033	1
65/304	2FT X 4FT LED TROFFER 40 WATT	40	100-277	90	3500K	4200	105	50K	045923643040	1
65/305	2FT X 4FT LED TROFFER 40 WATT	40	100-277	90	4000K	4400	110	50K	045923643057	1
65/306	2FT X 4FT LED TROFFER 40 WATT	40	100-277	90	5000K	4500	112	50K	045923643064	1
65/307	2FT X 4FT LED TROFFER 65 WATT	65	100-277	90	3500K	6500	100	50K	045923643071	1
65/308	2FT X 4FT LED TROFFER 65 WATT	65	100-277	90	4000K	6700	103	50K	045923643088	1
65/309	2FT X 4FT LED TROFFER 65 WATT	65	100-277	90	5000K	6900	106	50K	045923643095	1

Specifications

ITEM	SPECIFICATION	DETAILS
General Performance	Spacing Criteria	Available upon request
	Efficacy (LMW)	100lm/w 100lm/w
	CRI	>90
	Color Consistency	Proprietary binning for uniform color
	Lumen Maint. (L70)	50,000 hours
Electrical	Power Factor	Over 95%
	Input Voltage	100V-277V 50/60 Hz
	Power Consumption	40&50 watt nominal
Control	Dimming Switch	Standard 0-10V dimming 10%-100%
	Linking Lengths/Qty	15 cable feet x 20 panels
Physical	Housing	Aluminum
	Lens	Translucent white PS
	Mounting	Fits standard grid for drop ceilings
	Operating Temperature	-5°F to 104°F
	Humidity	20% - 85% RH, non condensing
Certification	Certification	c ETLus, DLC, FCC
	Material Usage	RoHS compliant; no mercury
	Environment	Damp location
	Warranty	Five year

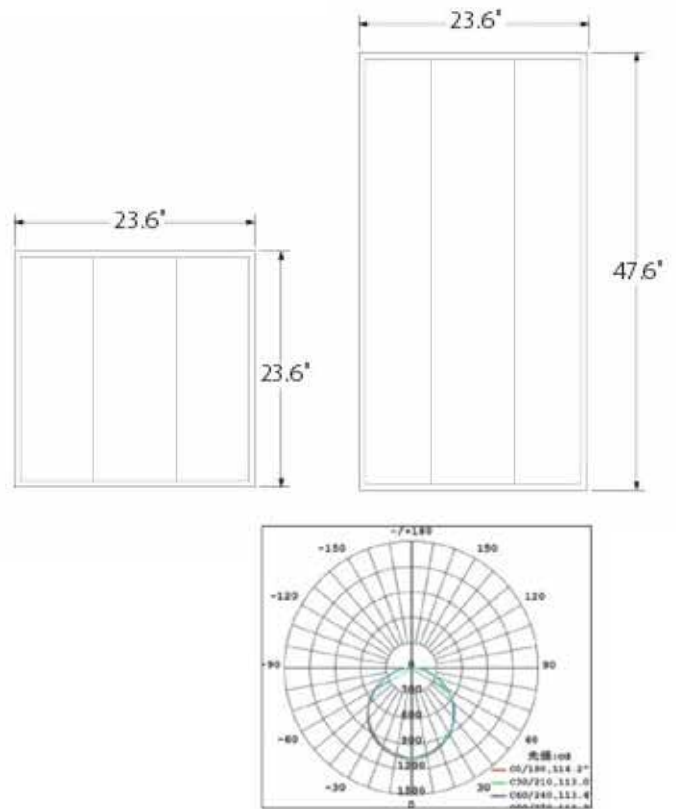

Brand	Description	Model	Load Max	Poles	Performance Rating
Lutron	Diva 0-10V control(gloss finish),single pole,preset,30mA sink,16A load(needs Power Pack PP-DV)	DVTV (DIVA)	120-277 30mA/16A	Single	Best
Lutron	Diva 0-10V control(gloss finish),single pole/3-way,preset,50mA sink,8A load	DVSTV (DIVA)	120-277 50mA/8A	Single pole/3-way	Best
Lutron	Diva 0-10V control(satin finish),single pole,preset,30mA sink,16A load(needs Power Pack PP-DV)	DVSVTV (DIVA)	120-277 30mA/16A	Single	Best
Lutron	Diva 0-10V control(Satin finish),single pole/3-way,preset,50mA sink,8A load	DVSCSTV (DIVA)	120-277 50mA/8A	Single pole/3-way	Best
Lutron	Maestro 0-10V Dimmer and Occupancy/Vacancy PIR Sensor, single pole/multilocation	MSZ101-WH	120-277	Single pole/Multi	Better
Lutron	Skylark Fluorescent Preset Dimmer, 120v dimmers also LEDcompatible with GRX-TV1	SF-103P-WH	120VAC/8A	3-way	Better
Cooper	Dimmable LED/FLR0-10V ballasts, DEVINE Slide Dimmer,single pole/3-way,preset	DF10P	1200W 120V/60Hz 1600W 277V/60Hz	Single pole/3-way	Best
Cooper	Dimmable LED/FLR0-10V ballasts, SKYE Slide Dimmer,single pole/3-way,preset	SF10P	1200W 120V/60Hz 1600W 277V/60Hz	Single pole/3-way	Best
Leviton	Designed for use with LED fixtures Using 0-10V power supplier,No power pack req. for switching	DS710	120VAC/60Hz 277VAC/60Hz		Best
Leviton	LED Dimmer for 0-10V power suppliers,no LED locator	IP710-LF	1200VA@120VAC 1500VA@277VAC	Single/2Gang/ 3-Gang	Best
Leviton	Renoir II Rotary, Ballast 0-10V, Standard Heat Sink Dimmer,Linear dimming, Narrow, 16 A, White	WRMG-7DW	120-277VAC 60HZ/16A		Better
Leviton	1200VA Preset Fluorescent Slide Dimmer, Single Pole and 3-Way	IP710-DLX	1200VA, 120/277 Volt AC60Hz	Single pole/3-way	Better
Leviton	Renoir II Preset Slide Dimmer,Linear dimming, Ballast 0-10V, Thin Heat Sink, Narrow, 16A, White	AWSMT-7DW	120-277VAC, 60HZ/16A		Limited
Leviton	Fluorescent Renoir II Slide Preset Master Dimmer	AWSMG-7DW	0-277VAC, 60HZ/16A		Limited

PRODUCT INFORMATION

LED Flush Mount Emergency Battery Back-up Ready (EMR)

EMR fixtures by Nuvo Lighting: Efficiency, safety and style all in one package.

This all-new collection of flush mount fixtures combines the latest in LED technologies, current safety standards and adds clean, contemporary design to create one of the most advanced fixtures in the industry. Each fixture is manufactured to easily accept an emergency battery back-up disk (sold separately), which quickly transforms these attractive flush fixtures into functional emergency lighting devices. These fixtures allow safety specifications to be met without sacrificing design or efficiency.

Features

- 100 Watt equivalent
- 20 Watts—over 80% energy savings
- 120-277V
- High color rendition (90+ CRI)
- Dimmable—120V only
- Dimming range 20%-100%
- Suitable for damp locations*
- Operating temperature -17°C to 45°C
- 5 Year warranty



62-977



62-981



62-978



62-982



62-975



62-971



62-976



62-972



LED flush mount utility fixtures

Item No.	Description	W	Finish	Light Source	CCT	Lum.	CRI	Life/Hours	Dimensions	UPC
62-971	20W/LED/3000K/90CRI/120-277V	20	Brushed Nickel	LED Module	3000K	1660	90+	40,000	15"w x 4"h	045923329715
62-972	20W/LED/3000K/90CRI/120-277V	20	Aged Bronze	LED Module	3000K	1660	90+	40,000	15"w x 4"h	045923329722
62-975	20W/LED/3000K/90CRI/120-277V	20	Polished Nickel	LED Module	3000K	1660	90+	40,000	14"w x 4.6"h	045923329753
62-976	20W/LED/3000K/90CRI/120-277V	20	Aged Bronze	LED Module	3000K	1660	90+	40,000	14"w x 4.6"h	045923329760
62-977	20W/LED/3000K/90CRI/120-277V	20	Brushed Nickel	LED Module	3000K	1660	90+	40,000	14"w x 5.4"h	045923329777
62-978	20W/LED/3000K/90CRI/120-277V	20	Aged Bronze	LED Module	3000K	1660	90+	40,000	14"w x 5.4"h	045923329784
62-981	20W/LED/3000K/90CRI/120-277V	20	Polished Nickel	LED Module	3000K	1660	90+	40,000	15"w x 4.5"h	045923329814
62-982	20W/LED/3000K/90CRI/120-277V	20	Aged Bronze	LED Module	3000K	1660	90+	40,000	15"w x 4.5"h	045923329821

*Not suitable for damp location if used with optional battery backup disk.

Emergency battery back-up disk ready

The emergency battery back-up disk, Satco model S9299 (120V) or Satco model S9780 (277V) (not included), easily mounts inside the pan of these fixtures instantly making them emergency lighting compliant. Battery back-up disk includes both the test button and indicator light. Batteries are easily accessible and included.

- Rechargeable batteries
- 90 minute run time



Remove the logo plate to mount the battery back-up indicator light and test button (included with battery back-up disk, sold separately).

Battery back-up disk (sold separately)



S9299 - 120V Battery back-up disk
S9780 - 277V Battery back-up disk



Test Button - System checks on the battery power & circuit connections

Indicator

- Red: Battery charging
- Green: Battery fully charged
- Yellow: Check system
- Off: Power outage, battery pack running

New Product Introduction

Battery back-up ready (EMR).
Indicator light and test button
Included with battery back-up
disk (sold separately).



14" LED Flush Mount Emergency battery back-up ready (EMR)

Applications

- Kitchens
- Bedrooms
- Baths
- Hallways
- Stairwells
- Office

Features

- 100W equivalent
- 20 Watts – over 80% energy savings
- 120–277V
- High color rendition (CRI 90+)
- Dimmable – 120V
- Dimming range: 20% -100%
- Suitable for damp location**
- Operating temperature: -17°C to 45°C
- White finish with durable polymer cover
- 5 Year warranty



Integrated circular
LED module for
consistency and
dependability.

Emergency battery back-up disk (not included)

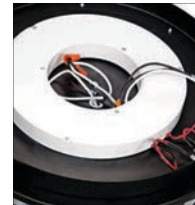

The emergency battery back-up disk, Satco model S9299 (120V) or Satco model S9780 (277V) (not included), easily mounts inside the pan of this fixture (below).

S9299
S9780



Dimensions

Width: 14", Height: 4 3/4"

LED flush mount utility fixture



Item Number	Description	Watts	Volts	Light Source	CCT	Lumens*	CRI	Life/ Hours	UPC
62-991*	20W/LED/14"UTILITY/30K/WH	20	120	LED Module	3000K	1300	90+	50,000	045923329913

**Not suitable for damp locations if used with optional battery back-up module.

PRODUCT INFORMATION

Décor LED Flush Fixtures

120V, 90CRI, 3000K

Applications

- Kitchens
- Bedrooms
- Hallways
- Stairwells
- Office

Features

- 100W equivalent
- 16.5 Watts – over 80% energy savings
- High color rendition (CRI 90+) 3000K CCT
- Dimmable
- 5 Year Warranty
- Four color retail package
- Acrylic diffuser

Dimensions

Width: 14", Height: 4 1/2"



62-985
Beige Fabric



62-990
White Fabric



62-988
Polished Nickel
White Fabric Shade



62-986
Natural Brass
White Fabric Shade



62-989
Polished Nickel
White Fabric Shade



62-987
Natural Brass
White Fabric Shade

Décor LED flush fixture



Item Number	Description	W	V	Light Source	Finish	CCT	Lum.	CRI	Life/Hours
62-985	14" Fabric Drum LED Fixture	16.5	120	LED Module	Beige Fabric	3000K	1150	90+	50,000
62-986	14" Filigree LED Fixture - White Fabric Shade	16.5	120	LED Module	Natural Brass	3000K	1150	90+	50,000
62-987	14" Filigree LED Fixture - White Fabric Shade	16.5	120	LED Module	Natural Brass	3000K	1150	90+	50,000
62-988	14" Filigree LED Fixture - White Fabric Shade	16.5	120	LED Module	Polished Nickel	3000K	1150	90+	50,000
62-989	14" Filigree LED Fixture - White Fabric Shade	16.5	120	LED Module	Polished Nickel	3000K	1150	90+	50,000
62-990	14" Fabric Drum LED Fixture	16.5	120	LED Module	White Fabric	3000K	1150	90+	50,000

Product Introduction

LED Utility Fixture

Screw-on or hardwire installation
7" Flush Mount with or without pull chain

Applications

- Closet
- Basement
- Garages
- Hallways
- Utility Rooms

Features

- Screws into most existing plastic or porcelain keyless lamp holders without any wiring required, or hard wire into junction boxes
- 65W Equivalent
- 13.5 Watts – over 80% energy savings
- Dimmable
- Dimming range 20%-100%
- Suitable for damp location
- White finish with durable polymer cover
- 5 Year warranty

Dimensions

Width: 7⁵/₈", Height: 3³/₄"



Two mounting options:

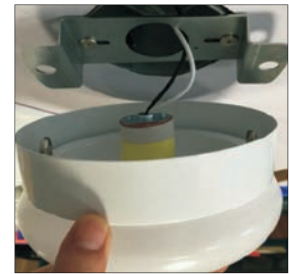

The Nuvo LED flush mount utility fixture can easily be mounted by simply screwing it onto an existing socket, or can be hard-wired using the porcelain socket adapter and junction box mounting bracket which are both supplied with the fixture.

LED flush mount utility fixture



Item Number	Description	Watts	Volts	Light Source	CCT	Lumens*	CRI	Life/Hours	UPC
62-961**	13W/LED/7"UTILITY/27K/WH/E26	13.5	120	LED Module	2700K	800	>90	50,000	045923329616
62-962**	13W/LED/7"UTILITY/30K/WH/E26	13.5	120	LED Module	3000K	820	>90	50,000	045923329623
62-963**	13W/LED/7"UTILITY/40K/WH/E26	13.5	120	LED Module	4000K	850	>90	50,000	045923329630
62-964	13W/LED/7"UTILITY/50K/WH/E26	13.5	120	LED Module	5000K	1050	>90	50,000	045923329647
62-965**	13W/LED/7"UTILITY/30K/WH/E26/PULLCHAIN	13.5	120	LED Module	3000K	820	>90	50,000	045923639654
62-966**	13W/LED/7"UTILITY/40K/WH/E26/PULLCHAIN	13.5	120	LED Module	4000K	860	>90	50,000	045923639661

*Lumens measured at LED source

PRODUCT INFORMATION

LED track heads and accessories

LED efficiency, high quality and great value.

Features

- Direct replacement for 75 Watt incandescent uses only 12 Watts
- 24° and 36° beam angles
- Dimmable
- 3000K
- 90+ CRI
- 820 lumens
- Long life: 30,000 Hours
- Sleek, clean design
- Die cast construction
- 3 Year warranty



Round

- TH401 White, 24°
 - TH403 White, 36°
 - TH402 Black, 24°
 - TH404 Black, 36°
 - TH405 Brushed Nickel, 24°
 - TH407 Brushed Nickel, 36°
- Dimensions: Width 3", Height 2 1/4", Ext. 5 1/8"

Pinch Back

- TH411 White, 24°
 - TH413 White, 36°
 - TH412 Black, 24°
 - TH414 Black, 36°
 - TH415 Brushed Nickel, 24°
 - TH417 Brushed Nickel, 36°
- Dimensions: Width 2 3/4", Height 2 3/4", Ext. 5 5/8"

Angle Arm

- TH421 White, 24°
 - TH423 White, 36°
 - TH422 Black, 24°
 - TH424 Black, 36°
 - TH425 Brushed Nickel, 24°
 - TH427 Brushed Nickel, 36°
- Dimensions: Width 2 1/2", Height 2 3/8", Ext. 6 1/4"

12 WATTS
REPLACES 75W
DIMMABLE
3000 K
90 CRI
30,000 HOURS

Item Number	Description	Watts	Beam	Finish	CCT	Lumens	Life/Hours
TH401	Round White 24° LED Track Head	12	24°	White	3000K	820	30,000
TH403	Round White 36° LED Track Head	12	36°	White	3000K	820	30,000
TH402	Round Black 24° LED Track Head	12	24°	Black	3000K	820	30,000
TH404	Round Black 36° LED Track Head	12	36°	Black	3000K	820	30,000
TH405	Round Brushed Nickel 24° LED Track Head	12	24°	Brushed Nickel	3000K	820	330,000
TH407	Round Brushed Nickel 36° LED Track Head	12	36°	Brushed Nickel	3000K	820	30,000
TH411	Pinch Back White 24° LED Track Head	12	24°	White	3000K	820	30,000
TH413	Pinch Back White 36° LED Track Head	12	36°	White	3000K	820	30,000
TH412	Pinch Back Black 24° LED Track Head	12	24°	Black	3000K	820	30,000
TH414	Pinch Back Black 36° LED Track Head	12	36°	Black	3000K	820	30,000
TH415	Pinch Back Brushed Nickel 24° LED Track Head	12	24°	Brushed Nickel	3000K	820	30,000
TH417	Pinch Back Brushed Nickel 36° LED Track Head	12	36°	Brushed Nickel	3000K	820	30,000
TH421	Angle Arm White 24° LED Track Head	12	24°	White	3000K	820	30,000
TH423	Angle Arm White 36° LED Track Head	12	36°	White	3000K	820	30,000
TH422	Angle Arm Black 24° LED Track Head	12	24°	Black	3000K	820	30,000
TH424	Angle Arm Black 36° LED Track Head	12	36°	Black	3000K	820	30,000
TH425	Angle Arm Brushed Nickel 24° LED Track Head	12	24°	Brushed Nickel	3000K	820	30,000
TH427	Angle Arm Brushed Nickel 36° LED Track Head	12	36°	Brushed Nickel	3000K	820	30,000

over →

Track accessories

Tracks

All tracks include two dead end caps and all mounting hardware
 Dimensions: Height 5/8", Width 1 5/16" (length and color options below)

Size	White	Black	Brushed Nickel
2 FT	TR118	TR119	TR126
4 FT	TR120	TR121	TR127
6 FT	TR124	TR125	TR128
8 FT	TR122	TR123	TR129

Master Carton / 6



Track Power Feeds



Floating Canopy

Electrifies the track anywhere along the length of the run
 TP154 White
 TP155 Black



Conduit Live End

Electrifies the track from the end of the run to a conduit pipe
 TP169 White
 TP170 Black



Live End and Canopy

Electrifies the track from the end of the run
 TP152 White
 TP153 Black



"T" Connector

Connects three tracks together in a "T" shape pattern
 TP148 White
 TP149 Black



Inline Feed

Connects tracks in a straight run and supplies power
 TP171 White
 TP172 Black

Master Carton / 12

Track Connectors



Mini Straight Connector

Connects tracks in a straight run
 TP144 White
 TP145 Black



"L" Connector

Connects tracks at a 90° angle
 TP146 White
 TP147 Black



"X" Connector

Connects four tracks together in an "X" shape pattern
 TP150 White
 TP151 Black



Flexible Connector

Variable angle connector
 TP167 White
 TP168 Black

Master Carton / 12

See NUVO Catalog #NU4030 for the complete track program.