

# MARSHALL STAMPING COMPANY

*Manufacturer of  
Quality Building Products  
Since 1951*

355 Glade Mills Road | Valencia, PA 16059-3315  
P: 800.635.1166 | P: 724.898.2900 | F: 724.898.3339

[www.marshallstamping.com](http://www.marshallstamping.com)

## Terms of Sale

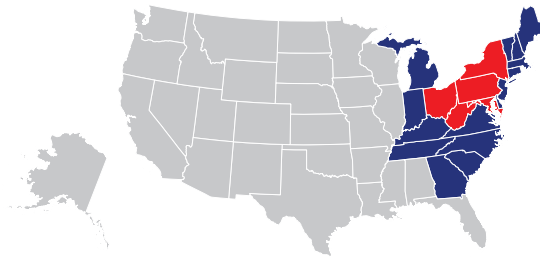

### PREPAID SHIPMENTS FROM FACTORY, VALENCIA, PA 16059

- Orders of Combined Products Over \$4,000.00 NET
- Shipped to Ohio, Pennsylvania, Upstate New York, and West Virginia
- Orders of Combined Products Over \$5,000.00 NET
- Shipped to Delaware, Indiana, Kentucky, Long Island, New York, Maryland, Michigan, New England, New Jersey, New York City, Northern Georgia, North and South Carolina, Tennessee, and Virginia

### F.O.B. SHIPMENTS FROM FACTORY, VALENCIA, PA 16059

- All orders not meeting the prepaid dollar requirements
- All orders in states not listed above
- Special quotations are available for larger dollar amounts, half and full truckloads

### FREIGHT CHARGE METHOD

- Collect, or
- Prepaid and Added to the Invoice

- Orders subject to credit approval of this company before shipment.
- Claims for shortage or damage must be made within 48 hours.  
Count and check shipments before signing "clear" delivery receipt of carrier.  
If shortages or damages are not noted on the carrier's delivery receipt at time of delivery, no claim can be allowed. Deductions from invoices for shortages or damage claims will not be allowed.
- No returns accepted without our prior written consent. Returned goods subject to a minimum 25% re-handling charge.
- All shipments are dependent upon absence of floods, fires, material commodity shortages, production and shipping interruptions or other circumstances beyond our control.
- Prices subject to change without notice.

## Terms of Payment

1% 10 Days – Net 30 Days

Interest at 1.5% monthly added on past due accounts.



# Index



Access Doors, Foundation .....	20
Anchor Bolts .....	19
Angles, Rolled .....	17
Area Walls and Grates (Standard Width) .....	8
Area Walls (Commercial Grade) .....	9, 10, and 11
Area Walls (Egress) .....	12
Area Wall Grates (Egress) .....	13
Area Wall Ladders (Egress) .....	13
Ash Dumps .....	22
Bar Strainers (Cast Iron) .....	23
Brick Clamps .....	23
Chimney Caps and Accessories .....	21
Cleanout Doors (Cast Iron and Steel) .....	22
Columns (Adjustable and Fixed) .....	3, 4, 5, and 6
Column Components and Tubing .....	7
Dampers and Controls (Cast Iron) .....	22
Foundation Anchors .....	19
Jack Posts .....	1 and 2
Lintels (Block and Brick) .....	18
Mortar Boxes .....	23
Nail Stakes (Steel) .....	20
Trench Drains .....	14 and 15
Trench Drain Load Capacities & Flow Rates .....	16
Ventilators, Foundation .....	20
Wall Ties .....	19



American Flag represents items **MADE IN U.S.A.**





## EXTEND-O-POST

Extend-O-Posts are perfect for temporarily reinforcing existing floors under heavy load areas, but are not recommended for permanent supports in new construction. There's nothing easier to use for supporting sagging floors, weak beams, and warping stairways. With Extend-O-Posts the possibilities are unlimited.

- Various load capacities; 8,000 lbs to 18,000 lbs\*
- Flow-coated with red corrosion-resistant paint
- Packed complete with installation instructions in a color coded, trilingual carton
- U.P.C. symbol on carton
- Standard Pallet Quantities for Model Nos. 79 and 84, 80 units; 84HD, 50 units

Model	Adjustment	Weight (#)	Maximum Load*	Carton Color Code
JP16	1'0" to 1'4"	5.0	15,000#	Brown
JP36	1'7" to 3'0"	9.0	10-14,000	Blue
JP55	2'10" to 4'7"	12.0	10-14,000	Purple
JP79	4'5" to 7'9"	17.5	8-12,000	Green
JP84	4'8" to 8'4"	19.0	8-12,000	Black
JP84HD	4'8" to 8'4"	25.0	10-18,000	Red

\*Maximum Load obtained at lowest adjustment.

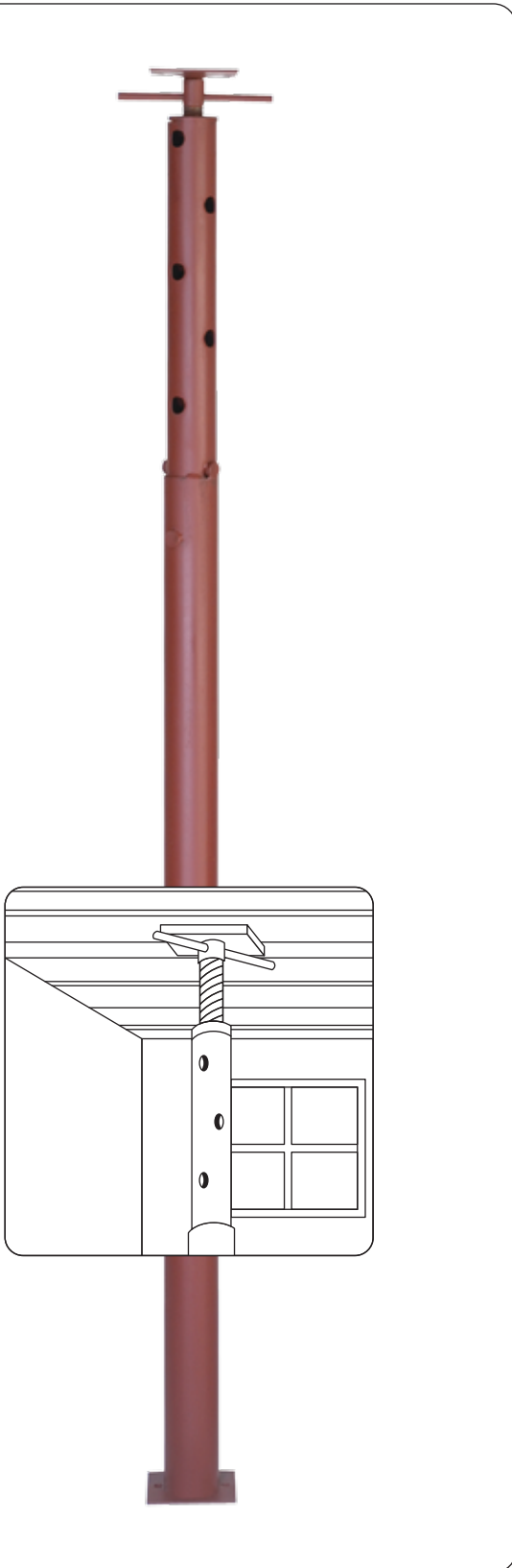

# Jack Posts



**SHORTY**  
NO. 16  
1'0" - 1'4"

**SHORTY**  
NO. 36  
1'7" - 3'0"

**SHORTY**  
NO. 55  
2'10" - 4'7"

**STANDARD**  
NO. 79  
4'5" - 7'9"

**STANDARD**  
NO. 84  
4'8" - 8'4"

**HEAVY DUTY**  
NO. 84HD  
4'8" - 8'4"

## Component Specifications

Standard Model Nos. 79, 84  
Shorty Model Nos. 16, 36, 55

- Inner Tube: 2-1/4" x 15 Gauge Prime Steel Tubing
- Outer Tube: 2-1/2" x 15 Gauge Prime Steel Tubing
- 2-1/4" Steel Collar
- 1" x 6" Steel Screw
- 2 - 4" x 4" x 10 Gauge Steel Plates
- 7" Turning Handle
- Grooved Pin and Plain Pin
- Trilingual, Color Coded Cartons

## Component Specifications

Heavy Duty Model No. 84HD

- Inner Tube: 2-1/2" x 14 Gauge Prime Steel Tubing
- Outer Tube: 2-3/4" x 14 Gauge Prime Steel Tubing
- 2-1/2" Steel Collar
- 1-1/4" x 6" Steel Screw
- 2 - 4" x 6" x 7 Gauge Steel Plates
- 7" Turning Handle
- Grooved Pin and Plain Pin
- Trilingual, Color Coded Carton



# Steel Columns



## Adjustable Length



3" DIAMETER ROUND   11 GAUGE – ADJUSTABLE			
Model	Adj. Length	Weight (#)	Maximum Load*
AC360	6'0" - 6'4"	29	18,700#
AC363	6'3" - 6'7"	30	18,200
AC366	6'6" - 6'10"	31	17,800
AC369	6'9" - 7'1"	32	17,300
AC370	7'0" - 7'4"	33	16,800
AC373	7'3" - 7'7"	34	16,300
AC376	7'6" - 7'10"	35	15,800
AC379	7'9" - 8'1"	36	15,300
AC380	8'0" - 8'4"	37	14,800
AC383	8'3" - 8'7"	38	14,200
AC386	8'6" - 8'10"	39	13,800
AC389	8'9" - 9'1"	40	13,300
AC390	9'0" - 9'4"	41	12,800
AC393	9'3" - 9'7"	42	12,300
AC396	9'6" - 9'10"	43	11,800
AC399	9'9" - 10'1"	44	11,300
AC3100	10'0" - 10'4"	45	10,900
AC3103	10'3" - 10'7"	46	10,400
AC3106	10'6" - 10'10"	47	10,100
AC3109	10'9" - 11'1"	48	9,500
AC3110	11'0" - 11'4"	49	9,100
AC3113	11'3" - 11'7"	50	8,700
AC3116	11'6" - 11'10"	51	8,300
AC3119	11'9" - 12'1"	52	8,000
AC3120	12'0" - 12'4"	53	7,600



- Complies with IRC and IBC
- Completely assembled: 4" x 8" plate welded to top end and 3-1/2" x 6" plate permanently attached to screw on bottom end
- Flow-coated inside and out with red corrosion-resistant paint
- Straps available upon request
- Special sizes available upon request
- Standard Bundles:  
3" – 25 pieces  
3-1/2" – 25 pieces

\*All loads listed are with adjustable screw completely extended and encased in concrete.



3-1/2" DIAMETER ROUND   11 GAUGE – ADJUSTABLE			
Model	Adj. Length	Weight (#)	Maximum Load*
AC3560	6'0" - 6'4"	33.5	23,800#
AC3563	6'3" - 6'7"	34.5	23,400
AC3566	6'6" - 6'10"	35.5	22,900
AC3569	6'9" - 7'1"	36.5	22,500
AC3570	7'0" - 7'4"	37.5	22,000
AC3573	7'3" - 7'7"	38.5	21,500
AC3576	7'6" - 7'10"	39.5	21,000
AC3579	7'9" - 8'1"	40.5	20,500
AC3580	8'0" - 8'4"	41.5	20,000
AC3583	8'3" - 8'7"	42.5	19,500
AC3586	8'6" - 8'10"	43.5	19,000
AC3589	8'9" - 9'1"	44.5	18,600
AC3590	9'0" - 9'4"	45.5	18,100
AC3593	9'3" - 9'7"	46.5	17,500
AC3596	9'6" - 9'10"	47.5	17,100
AC3599	9'9" - 10'1"	48.5	16,600
AC35100	10'0" - 10'4"	49.5	16,100
AC35103	10'3" - 10'7"	50.5	15,600
AC35106	10'6" - 10'10"	51.5	15,100
AC35109	10'9" - 11'1"	52.5	14,600
AC35110	11'0" - 11'4"	53.5	14,100
AC35113	11'3" - 11'7"	54.5	13,700
AC35116	11'6" - 11'10"	55.5	13,200
AC35119	11'9" - 12'1"	56.5	12,700
AC35120	12'0" - 12'4"	57.5	12,200

### IMPORTANT

Column selection should be based upon structural calculations completed by a registered, professional engineer. Not responsible for the installation, alteration, or modification of any completed product, or the usage of any component in the fabrication of any product beyond our control

See ATI-ES Code Compliance Research Report (CCRR-0145)

See CCMC Registry of Product Evaluations (CCMC 13610-L) for use in Canada.





# Steel Columns



## Adjustable Length



**4" DIAMETER ROUND | 11 GAUGE – ADJUSTABLE**

Model	Adj. Length	Weight (#)	Maximum Load*
AC460	6'0" - 6'4"	37.8	28,900#
AC463	6'3" - 6'7"	39.0	28,500
AC466	6'6" - 6'10"	40.3	28,100
AC469	6'9" - 7'1"	41.5	27,600
AC470	7'0" - 7'4"	42.8	27,200
AC473	7'3" - 7'7"	44.0	26,800
AC476	7'6" - 7'10"	45.3	26,300
AC479	7'9" - 8'1"	46.5	25,800
AC480	8'0" - 8'4"	47.8	25,300
AC483	8'3" - 8'7"	49.0	24,800
AC486	8'6" - 8'10"	50.3	24,400
AC489	8'9" - 9'1"	51.5	23,900
AC490	9'0" - 9'4"	52.8	23,400
AC493	9'3" - 9'7"	54.0	23,000
AC496	9'6" - 9'10"	55.3	22,400
AC499	9'9" - 10'1"	56.5	21,900
AC4100	10'0" - 10'4"	57.8	21,400
AC4103	10'3" - 10'7"	59.0	20,900
AC4106	10'6" - 10'10"	60.3	20,400
AC4109	10'9" - 11'1"	61.5	19,900
AC4110	11'0" - 11'4"	62.8	19,500
AC4113	11'3" - 11'7"	64.0	18,900
AC4116	11'6" - 11'10"	65.3	18,400
AC4119	11'9" - 12'1"	66.5	17,900
AC4120	12'0" - 12'4"	67.8	17,400

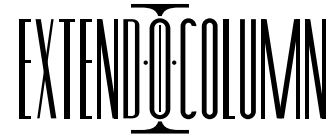

- Complies with IRC and IBC
- Completely assembled: 4" x 8" plate welded to top end and 3-1/2" x 6" plate permanently attached to screw on bottom end
- Flow-coated inside and out with red corrosion-resistant paint
- Straps available upon request
- Special sizes available upon request
- Standard Bundles: 4" – 20 pieces  
3-1/2", .216 wall – 25 pieces

\*All loads listed are with adjustable screw completely extended and encased in concrete.



**3-1/2" DIAMETER ROUND | .216 WALL – ADJUSTABLE**

Model	Adj. Length	Weight (#)	Maximum Load*
AC3560216	6'0" - 6'4"	52.7	41,500#
AC3563216	6'3" - 6'7"	54.6	40,600
AC3566216	6'6" - 6'10"	56.5	39,900
AC3569216	6'9" - 7'1"	58.4	39,000
AC3570216	7'0" - 7'4"	60.3	38,200
AC3573216	7'3" - 7'7"	62.2	37,300
AC3576216	7'6" - 7'10"	64.1	36,400
AC3579216	7'9" - 8'1"	66.0	35,500
AC3580216	8'0" - 8'4"	67.9	34,700
AC3583216	8'3" - 8'7"	69.8	33,800
AC3586216	8'6" - 8'10"	71.7	32,800
AC3589216	8'9" - 9'1"	73.6	31,900
AC3590216	9'0" - 9'4"	75.5	31,000
AC3593216	9'3" - 9'7"	77.4	30,000
AC3596216	9'6" - 9'10"	79.3	29,200
AC3599216	9'9" - 10'1"	81.2	28,300
AC35100216	10'0" - 10'4"	83.1	27,400
AC35103216	10'3" - 10'7"	85.0	26,600
AC35106216	10'6" - 10'10"	86.9	25,700
AC35109216	10'9" - 11'1"	88.8	24,800
AC35110216	11'0" - 11'4"	90.7	23,900
AC35113216	11'3" - 11'7"	92.6	23,100
AC35116216	11'6" - 11'10"	94.5	22,300
AC35119216	11'9" - 12'1"	96.4	21,400
AC35120216	12'0" - 12'4"	98.3	20,700

### IMPORTANT

Column selection should be based upon structural calculations completed by a registered, professional engineer. Not responsible for the installation, alteration, or modification of any completed product, or the usage of any component in the fabrication of any product beyond our control

See ATI-ES Code Compliance Research Report (CCRR-0145)

See CCMC Registry of Product Evaluations (CCMC 13610-L) for use in Canada.



# Steel Columns



## Fixed Length



3" DIAMETER ROUND   11 GAUGE – FIXED			
Model	Length	Weight (#)	Maximum Load
FC359	5'9"	25	19,200#
FC360	6'0"	26	18,700
FC363	6'3"	27	18,200
FC366	6'6"	28	17,800
FC369	6'9"	29	17,300
FC370	7'0"	30	16,800
FC373	7'3"	31	16,300
FC376	7'6"	32	15,800
FC379	7'9"	33	15,300
FC380	8'0"	34	14,800
FC383	8'3"	35	14,200
FC386	8'6"	36	13,800
FC389	8'9"	37	13,300
FC390	9'0"	38	12,800
FC393	9'3"	39	12,300
FC396	9'6"	40	11,800
FC399	9'9"	41	11,300
FC3100	10'0"	42	10,900
FC3103	10'3"	43	10,400
FC3106	10'6"	44	10,100
FC3109	10'9"	45	9,500
FC3110	11'0"	46	9,100
FC3113	11'3"	47	8,700
FC3116	11'6"	48	8,300
FC3119	11'9"	49	8,000
FC3120	12'0"	50	7,600

- Complies with IRC and IBC when shipped fully assembled as shown
- Commonly shipped with two, 4" x 8" plates; one welded to the tube, one unattached
- Flow-coated inside and out with red corrosion-resistant paint
- Straps available upon request
- Special sizes available upon request
- Standard Bundles:  
3" – 25 pieces  
3-1/2" – 25 pieces



3-1/2" DIAMETER ROUND   11 GAUGE – FIXED			
Model	Length	Weight (#)	Maximum Load
FC3559	5'9"	29	24,200#
FC3560	6'0"	30	23,800
FC3563	6'3"	31	23,400
FC3566	6'6"	32	22,900
FC3569	6'9"	33	22,500
FC3570	7'0"	34	22,000
FC3573	7'3"	35	21,500
FC3576	7'6"	36	21,000
FC3579	7'9"	37	20,500
FC3580	8'0"	38	20,000
FC3583	8'3"	39	19,500
FC3586	8'6"	40	19,000
FC3589	8'9"	41	18,600
FC3590	9'0"	42	18,100
FC3593	9'3"	43	17,500
FC3596	9'6"	44	17,100
FC3599	9'9"	45	16,600
FC35100	10'0"	46	16,100
FC35103	10'3"	47	15,600
FC35106	10'6"	48	15,100
FC35109	10'9"	49	14,600
FC35110	11'0"	50	14,100
FC35113	11'3"	51	13,700
FC35116	11'6"	52	13,200
FC35119	11'9"	53	12,700
FC35120	12'0"	54	12,200

### IMPORTANT

Column selection should be based upon structural calculations completed by a registered, professional engineer. Not responsible for the installation, alteration, or modification of any completed product, or the usage of any component in the fabrication of any product beyond our control

See ATI-ES Code Compliance Research Report (CCRR-0145)





# Steel Columns



## Fixed Length



4" DIAMETER ROUND | 11 GAUGE  
See ATI-ES Code Compliance Research Report (CCRR-0145)

4" DIAMETER ROUND   11 GAUGE – FIXED			
Model	Length	Weight (#)	Maximum Load
FC459	5'9"	32.8	29,400#
FC460	6'0"	34.0	28,900
FC463	6'3"	35.3	28,500
FC466	6'6"	36.5	28,100
FC469	6'9"	37.8	27,600
FC470	7'0"	39.0	27,200
FC473	7'3"	40.3	26,800
FC476	7'6"	41.5	26,300
FC479	7'9"	42.8	25,800
FC480	8'0"	44.0	25,300
FC483	8'3"	45.3	24,800
FC486	8'6"	46.5	24,400
FC489	8'9"	47.8	23,900
FC490	9'0"	49.0	23,400
FC493	9'3"	50.3	23,000
FC496	9'6"	51.5	22,400
FC499	9'9"	52.8	21,900
FC4100	10'0"	54.0	21,400
FC4103	10'3"	55.4	20,900
FC4106	10'6"	56.7	20,400
FC4109	10'9"	58.0	19,900
FC4110	11'0"	59.4	19,500
FC4113	11'3"	60.8	18,900
FC4116	11'6"	62.1	18,400
FC4119	11'9"	63.5	17,900
FC4120	12'0"	64.8	17,400

- Complies with IRC and IBC when shipped fully assembled as shown
- Commonly shipped with two, 4" x 8" plates; one welded to the tube, one unattached
- Flow-coated inside and out with red corrosion-resistant paint
- Straps available upon request
- Special sizes available upon request
- Standard Bundles:  
4" – 20 pieces  
3-1/2", .216 wall – 25 pieces



3-1/2" DIAMETER ROUND | .216 WALL  
See ATI-ES Code Compliance Research Report (CCRR-0145)

3-1/2" DIAMETER ROUND   .216 WALL – FIXED			
Model	Length	Weight (#)	Maximum Load
FC3559216	5'9"	47.7	42,300#
FC3560216	6'0"	49.6	41,500
FC3563216	6'3"	51.5	40,600
FC3566216	6'6"	53.4	39,900
FC3569216	6'9"	55.3	39,000
FC3570216	7'0"	57.2	38,200
FC3573216	7'3"	59.1	37,300
FC3576216	7'6"	61.0	36,400
FC3579216	7'9"	62.9	35,500
FC3580216	8'0"	64.8	34,700
FC3583216	8'3"	66.7	33,800
FC3586216	8'6"	68.6	32,000
FC3589216	8'9"	70.5	31,900
FC3590216	9'0"	72.4	31,020
FC3593216	9'3"	74.3	30,000
FC3596216	9'6"	76.2	29,200
FC3599216	9'9"	78.1	28,300
FC35100216	10'0"	80.0	27,400
FC35103216	10'3"	82.4	26,600
FC35106216	10'6"	84.0	25,700
FC35109216	10'9"	86.0	24,800
FC35110216	11'0"	88.0	23,900
FC35113216	11'3"	90.0	23,100
FC35116216	11'6"	92.0	22,300
FC35119216	11'9"	94.0	21,400
FC35120216	12'0"	96.0	20,700

### IMPORTANT

Column selection should be based upon structural calculations completed by a registered, professional engineer. Not responsible for the installation, alteration, or modification of any completed product, or the usage of any component in the fabrication of any product beyond our control

See ATI-ES Code Compliance Research Report (CCRR-0145)



# Column Components and Tubing

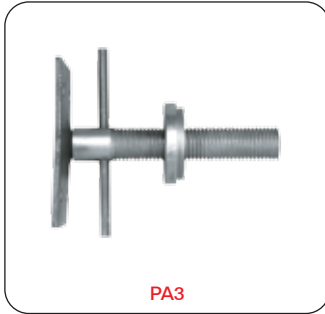

PA3

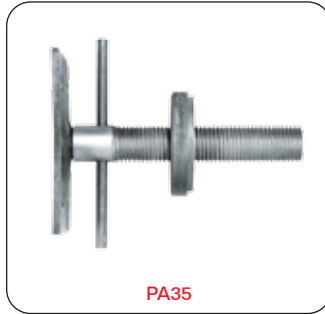

PA35

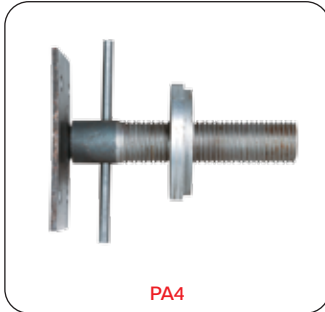

PA4

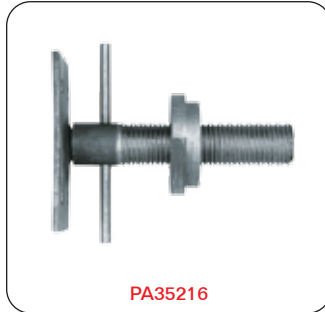

PA35216

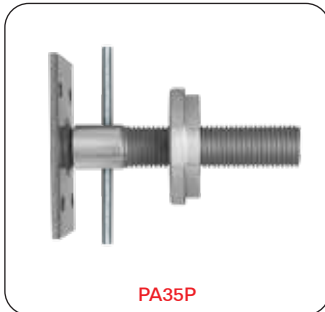

PA35P

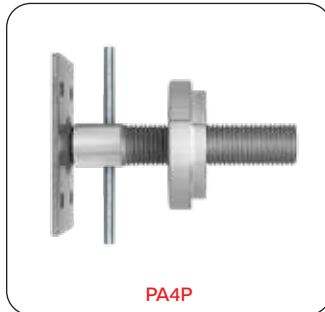

PA4P

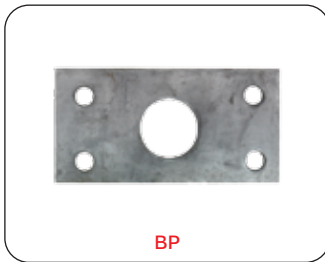

BP

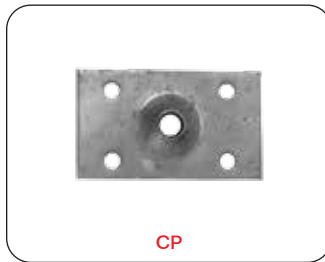

CP

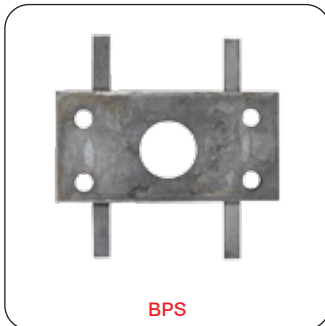

BPS

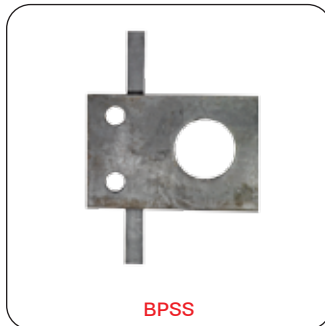

BPSS

## PERMANENT SCREW ASSEMBLY (CP PLATE ATTACHED TO SCREW)

Model	Size	Adjustment	Weight (#)	Maximum Load*
PA3	3" O.D. Tube	4"	4.5	18,700#
PA35	3-1/2" O.D. Tube	4"	5.5	23,800
PA4	4" O.D. Tube	4"	6.5	28,900
PA35216	3-1/2" O.D. x .216 Wall	4"	6.5	41,500
PA35P	3-1/2" Sch 40 Pipe, 4" O.D.	4"	7.5	60,078
PA4P	4" Sch 40 Pipe, 4-1/2" O.D.	4"	8.5	60,078

Turning Bar Included with Each Assembly

\*All Screw Assemblies must be encased in minimum 3,500 psi concrete; installed head first, with collar nut buried.

## 11 GAUGE TUBING | A500 GRADE B (ITEMS NOT SHOWN)

Model	Size	Length	Weight (#)
T324	3" O.D.	24'	89
T3524	3-1/2" O.D.	24'	103
T424	4" O.D.	24'	120

## .216 WALL TUBING | A500 GRADE B (ITEM NOT SHOWN)

Model	Size	Length	Weight (#)
T3524216	3-1/2" O.D.	24'	182

## COLUMN PLATES

Model	Dimensions	Weight (#)
BP	4" x 8" x 1/4" - 2" Center hole	2.0
BPS	4" x 8" x 1/4" - 2" Center hole w/ straps	2.3
BPSS	4" x 5-3/4" x 1/4" - 2" Center hole	1.5
CP	3-1/2" x 6" x 1/4" - 5/8" Center hole	1.5
PS	1/8" x 8" x 5/8" Straps (2) welded to above B plate.	0.5
TB	3/8" x 7" Turning Bar	0.5

Shipped: Loose

- BP: Top plate for adjustable columns; top and bottom for fixed columns
- BPS: BP with straps
- BPSS: Shorter length fits corners of partition walls
- CP: Used with permanent assembly
- Plates have full bearing on all common beam flanges
- Holes provided for bolt or lag-screw attachment to beam

## IMPORTANT

Not responsible for the installation, alteration, or modification of any completed product, or the usage of any component in the fabrication of any product beyond our control



# AW | Area Walls



Standard Width | 22 Gauge



ROUND TYPE | WIDTH 37" | PROJ. 16" | ROUNDED CORNERS

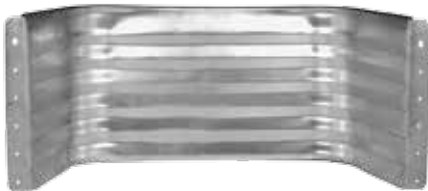

STRAIGHT TYPE | WIDTH 37" | PROJ. 12" | ROUNDED CORNERS



FOUNDATION VENT | ROUND TYPE | WIDTH 19-1/2" | PROJ. 10"

## STANDARD WIDTH 37" | ROUND OR STRAIGHT TYPE | GALV. STEEL

Model	Nominal Height	Weight Each (#)
AW12	12"	7
AW15	15"	8
AW18	18"	10
AW24	24"	13
AW30	30"	16
AW36	36"	20
AW48	48"	25

Shipped: Wired Bundles of 5

## FOUNDATION VENT AREA WALL | ROUND TYPE | GALV. STEEL

WIDTH 19-1/2" | PROJECTION 10"

Model	Nominal Height	Weight Each (#)
AWFV	12"	5

Shipped: Strapped Bundles of 10

- Rolled top on all standard area walls
- 12", 18", 24", and foundation vent area walls have rounded bottom corners for extra safety
- Stamped from single steel sheet
- Bright finish reflects light into basement
- Holes in flanges for bolting to wall
- Deep corrugation stiffens against back fill
- Minimum G-60 galvanized coating
- All back filling should be done gradually to prevent excessive pressure against area wall

# AWG | Area Wall Grates



Standard Width

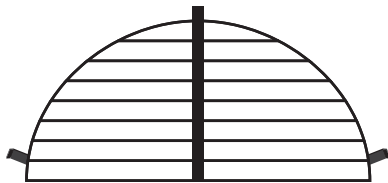

AWGRG

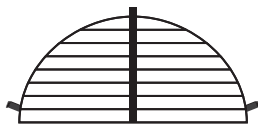

GFVAWG

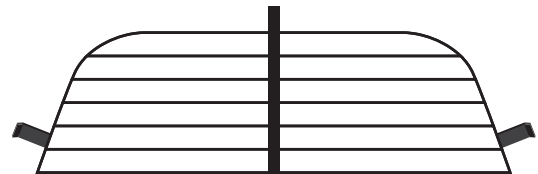

AWGSG

## STEEL GRATES | ROUND OR STRAIGHT TYPE

Model	Width	Weight Each (#)
AWGRG	37"	10.0
AWGSG	37"	10.0
GFVAWG	19-1/2"	3.5

- Hot-dipped galvanized finish
- Grating type admits maximum light and air into basement



# ARC | Round Style



Commercial Grade | 18 Gauge



- Ideal for the intermediate basement window size
- 18 gauge G-90 galvanized steel for normal soil loading
- Corrugation depth full 1/2" giving maximum strength
- Rolled top and bottom edge standard on 48", 60", and higher area walls
- Rounded corners for safety
- Holes in flanges for bolting to wall

**Configurations of any other Width, Height, or Projection available upon request.**

Model	Width	Projection	Height	Weight (#)
ARC311412	31"	14"	12"	9
ARC311418	31"	14"	18"	15
ARC311424	31"	14"	24"	19
ARC311430	31"	14"	30"	24
ARC311436	31"	14"	36"	28
ARC311448	31"	14"	48"	38
ARC311460	31"	14"	60"	46
ARC311472	31"	14"	72"	61
ARC351812	35"	18"	12"	11
ARC351818	35"	18"	18"	18
ARC351824	35"	18"	24"	24
ARC351830	35"	18"	30"	29
ARC351836	35"	18"	36"	35
ARC351848	35"	18"	48"	47
ARC351860	35"	18"	60"	57
ARC351872	35"	18"	72"	75
ARC372012	37"	20"	12"	12
ARC372018	37"	20"	18"	20
ARC372024	37"	20"	24"	26
ARC372030	37"	20"	30"	32
ARC372036	37"	20"	36"	38
ARC372048	37"	20"	48"	52
ARC372060	37"	20"	60"	61
ARC372072	37"	20"	72"	83
ARC402012	40"	20"	12"	13
ARC402018	40"	20"	18"	20
ARC402024	40"	20"	24"	26
ARC402030	40"	20"	30"	32
ARC402036	40"	20"	36"	39
ARC402048	40"	20"	48"	52
ARC402060	40"	20"	60"	63
ARC402072	40"	20"	72"	83
ARC462012	46"	20"	12"	13
ARC462018	46"	20"	18"	21
ARC462024	46"	20"	24"	28
ARC462030	46"	20"	30"	34
ARC462036	46"	20"	36"	40
ARC462048	46"	20"	48"	54
ARC462060	46"	20"	60"	66
ARC462072	46"	20"	72"	87



# AQC | Square Style



Commercial Grade | 18 Gauge | 4" Radius Corners



- Sharp 4" radius corner to maximize usable open area inside area wall perimeter
- 18 gauge G-90 galvanized steel for normal soil loading
- Corrugation depth full 1/2" giving maximum strength
- Rolled top and bottom edge standard on 48", 60", and higher area walls
- Rounded corners for safety
- Holes in flanges for bolting to wall

**Configurations of any other Width, Height, or Projection available upon request.**

Model	Width	Projection	Height	Weight (#)
AQC292212	29"	22"	12"	14
AQC292218	29"	22"	18"	22
AQC292224	29"	22"	24"	29
AQC292230	29"	22"	30"	36
AQC292236	29"	22"	36"	43
AQC292248	29"	22"	48"	57
AQC292260	29"	22"	60"	70
AQC292272	29"	22"	72"	92
AQC322412	32"	24"	12"	15
AQC322418	32"	24"	18"	24
AQC322424	32"	24"	24"	32
AQC322430	32"	24"	30"	39
AQC322436	32"	24"	36"	47
AQC322448	32"	24"	48"	63
AQC322460	32"	24"	60"	76
AQC322472	32"	24"	72"	101
AQC363012	36"	30"	12"	18
AQC363018	36"	30"	18"	29
AQC363024	36"	30"	24"	38
AQC363030	36"	30"	30"	47
AQC363036	36"	30"	36"	56
AQC363048	36"	30"	48"	75
AQC363060	36"	30"	60"	91
AQC363072	36"	30"	72"	121
AQC422412	42"	24"	12"	17
AQC422418	42"	24"	18"	27
AQC422424	42"	24"	24"	36
AQC422430	42"	24"	30"	44
AQC422436	42"	24"	36"	52
AQC422448	42"	24"	48"	70
AQC422460	42"	24"	60"	85
AQC422472	42"	24"	72"	113



# ACC | Non-Egress Casement Style



Commercial Grade | 18 Gauge | 9" Radius Corners



- Ideal for larger basement windows
- 18 gauge G-90 galvanized steel for normal soil loading
- Corrugation depth full 1/2" giving maximum strength
- Rolled top and bottom edge standard on 48", 60", and higher area walls
- Rounded corners for safety
- Holes in flanges for bolting to wall
- 16 gauge available on selected sizes

**Configurations of any other Width, Height, or Projection available upon request.**

Model	Width	Projection	Height	Weight (#)
ACC372012	37"	20"	12"	13
ACC372018	37"	20"	18"	21
ACC372024	37"	20"	24"	28
ACC372030	37"	20"	30"	34
ACC372036	37"	20"	36"	41
ACC372048	37"	20"	48"	55
ACC372060	37"	20"	60"	67
ACC372072	37"	20"	72"	88
ACC373012	37"	30"	12"	17
ACC373018	37"	30"	18"	27
ACC373024	37"	30"	24"	35
ACC373030	37"	30"	30"	43
ACC373036	37"	30"	36"	52
ACC373048	37"	30"	48"	70
ACC373060	37"	30"	60"	85
ACC373072	37"	30"	72"	112
ACC422412	42"	24"	12"	16
ACC422418	42"	24"	18"	25
ACC422424	42"	24"	24"	33
ACC422430	42"	24"	30"	40
ACC422436	42"	24"	36"	48
ACC422448	42"	24"	48"	65
ACC422460	42"	24"	60"	79
ACC422472	42"	24"	72"	104
ACC461812	46"	18"	12"	14
ACC461818	46"	18"	18"	23
ACC461824	46"	18"	24"	30
ACC461830	46"	18"	30"	37
ACC461836	46"	18"	36"	44
ACC461848	46"	18"	48"	59
ACC461860	46"	18"	60"	72
ACC461872	46"	18"	72"	95
ACC482412	48"	24"	12"	17
ACC482418	48"	24"	18"	27
ACC482424	48"	24"	24"	35
ACC482430	48"	24"	30"	43
ACC482436	48"	24"	36"	52
ACC482448	48"	24"	48"	69
ACC482460	48"	24"	60"	84
ACC482472	48"	24"	72"	111

Model	Width	Projection	Height	Weight (#)
ACC551812	55"	18"	12"	16
ACC551818	55"	18"	18"	25
ACC551824	55"	18"	24"	33
ACC551830	55"	18"	30"	41
ACC551836	55"	18"	36"	49
ACC551848	55"	18"	48"	66
ACC551860	55"	18"	60"	80
ACC551872	55"	18"	72"	106
ACC591812	59"	18"	12"	17
ACC591818	59"	18"	18"	27
ACC591824	59"	18"	24"	35
ACC591830	59"	18"	30"	43
ACC591836	59"	18"	36"	51
ACC591848	59"	18"	48"	69
ACC591860	59"	18"	60"	84
ACC591872	59"	18"	72"	111
ACC603012	60"	30"	12"	21
ACC603018	60"	30"	18"	34
ACC603024	60"	30"	24"	44
ACC603030	60"	30"	30"	55
ACC603036	60"	30"	36"	65
ACC603048	60"	30"	48"	88
ACC603060	60"	30"	60"	106
ACC603072	60"	30"	72"	142
ACC672412	67"	24"	12"	20
ACC672418	67"	24"	18"	32
ACC672424	67"	24"	24"	42
ACC672430	67"	24"	30"	52
ACC672436	67"	24"	36"	62
ACC672448	67"	24"	48"	84
ACC672460	67"	24"	60"	102
ACC672472	67"	24"	72"	135
ACC722412	72"	24"	12"	21
ACC722418	72"	24"	18"	34
ACC722424	72"	24"	24"	44
ACC722430	72"	24"	30"	55
ACC722436	72"	24"	36"	65
ACC722448	72"	24"	48"	88
ACC722460	72"	24"	60"	107
ACC722472	72"	24"	72"	142





# AEC | Egress Casement Style



Commercial Grade | 18 Gauge | 9" Radius Corners



- Meets IRC 2015 Egress specifications
- 18 gauge G-90 galvanized steel\* for normal soil loading
- Corrugation depth full 1/2" giving maximum strength
- Rolled top and bottom edge standard on 48", 60", and higher area walls
- Rounded corners for safety
- Holes in flanges for bolting to wall
- 16 gauge available on selected sizes

- \* • 18 gauge G-90 galvanized steel also available with pre-painted white finish inside; gray finish outside before fabrication
- Inside paint finish protected with strippable clear plastic laminate
- Special packaging of pallet quantities to help protect paint finish during shipment
- 48" and 60" heights standard

**Configurations of any other Width, Height, or Projection available upon request.**

Model	Width	Projection	Height	Weight (#)
AEC423612	42"	36"	12"	20
AEC423618	42"	36"	18"	32
AEC423624	42"	36"	24"	42
AEC423630	42"	36"	30"	52
AEC423636	42"	36"	36"	62
AEC423648	42"	36"	48"	83
AEC423660	42"	36"	60"	101
AEC423672	42"	36"	72"	134
AEC443612	44"	36"	12"	20
AEC443618	44"	36"	18"	33
AEC443624	44"	36"	24"	42
AEC443630	44"	36"	30"	53
AEC443636	44"	36"	36"	63
AEC443648	44"	36"	48"	84
AEC443660	44"	36"	60"	103
AEC443672	44"	36"	72"	136
AEC503612	50"	36"	12"	21
AEC503618	50"	36"	18"	34
AEC503624	50"	36"	24"	45
AEC503630	50"	36"	30"	52
AEC503636	50"	36"	36"	66
AEC503648	50"	36"	48"	89
AEC503660	50"	36"	60"	108
AEC503672	50"	36"	72"	140
AEC523612	52"	36"	12"	22
AEC523618	52"	36"	18"	35
AEC523624	52"	36"	24"	46
AEC523630	52"	36"	30"	57
AEC523636	52"	36"	36"	67
AEC523648	52"	36"	48"	91
AEC523660	52"	36"	60"	110
AEC523672	52"	36"	72"	147
AEC553612	55"	36"	12"	22
AEC553618	55"	36"	18"	36
AEC553624	55"	36"	24"	47
AEC553630	55"	36"	30"	58
AEC553636	55"	36"	36"	69
AEC553648	55"	36"	48"	93
AEC553660	55"	36"	60"	113
AEC553672	55"	36"	72"	150

Model	Width	Projection	Height	Weight (#)
AEC603612	60"	36"	12"	23
AEC603618	60"	36"	18"	37
AEC603624	60"	36"	24"	49
AEC603630	60"	36"	30"	60
AEC603636	60"	36"	36"	72
AEC603648	60"	36"	48"	97
AEC603660	60"	36"	60"	118
AEC603672	60"	36"	72"	156
AEC673612	67"	36"	12"	24
AEC673618	67"	36"	18"	39
AEC673624	67"	36"	24"	52
AEC673630	67"	36"	30"	64
AEC673636	67"	36"	36"	76
AEC673648	67"	36"	48"	102
AEC673660	67"	36"	60"	124
AEC673672	67"	36"	72"	165

**AEC5236XX CASEMENT STYLE EXAMPLE**

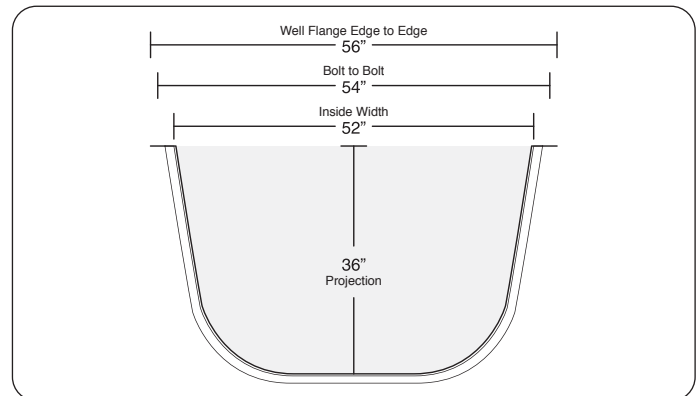

## AL | Egress Area Wall Ladders



Model	Area Wall Height	Rungs	Overall Height	Weight (#)
AL-3GHD	48" thru 60"	3	46-1/2"	10
AL-4GHD	72" thru 84"	4	70"	13

- IRC 310.2.1 compliant for egress
- Welded steel construction
- Coated with corrosion-resistant white paint or hot-dipped galvanized after fabrication
- Mounting holes for attachment to area wall

## AG | Egress Area Wall Grates



Steel Grates | Bar and Expanded Metal Styles



Model	Description	Weight (#)
AGC4236	Fits All 42" x 36" Area Walls	25
AGC4436	Fits All 44" x 36" Area Walls	27
AGC5036	Fits All 50" x 36" Area Walls	30
AGC5236	Fits All 52" x 36" Area Walls	31
AGC5536	Fits All 55" x 36" Area Walls	33
AGC6036	Fits All 60" x 36" Area Walls	36
AGC6736	Fits All 67" x 36" Area Walls	41

- IRC 310.4 compliant for egress
- Welded steel construction
- Coated with corrosion-resistant paint or hot-dipped galvanized after fabrication
- Expanded metal grates available painted white or bronze
- Other sizes of round, square or casement styles available upon request.



# Trench Drain



## Steel Grate

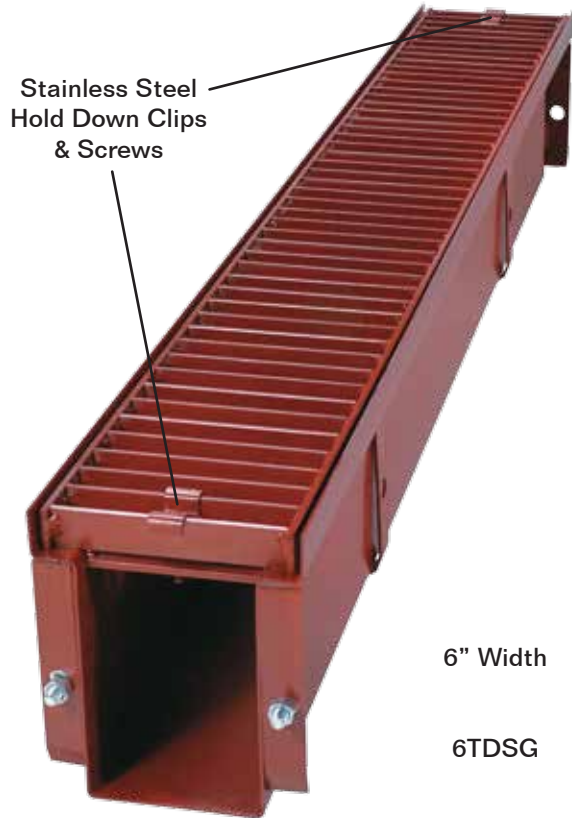

6" Width

6TDSG



8" and 12" Widths

8TDSG  
12TDSG

Model	Size	Description	Weight (#)
6TDSG	6"	Steel Bottom w/ Steel Grate	10.0/Ft.
6TDB	6"	Steel Bottom Box Only	5.0/Ft.
6SG	6"	Steel Grate Only	5.0/Ft.
6EPS	6"	Steel End Plate – Solid	1.0
6EPSWH	6"	Steel End Plate w/ 4-1/4" Hole	0.9
8TDSG	8"	Open Bottom w/ Steel Grate	13.5/Ft.
8TDB	8"	Open Bottom Box Only	6.3/Ft.
8SG	8"	Steel Grate Only	5.5/Ft.
8EPS	8"	Steel End Plate – Solid	2.0
8EPSWH	8"	Steel End Plate w/ 4-1/4" Hole	1.5
12TDSG	12"	Open Bottom w/ Steel Grate	14.8/Ft.
12TDB	12"	Open Bottom Box Only	6.5/Ft.
12SG	12"	Steel Grate Only	8.0/Ft.
12EPS	12"	Steel End Plate – Solid	2.6
12EPSWH	12"	Steel End Plate w/ 4-1/4" Hole	2.4

- Durable construction for residential and light commercial applications
- Trench boxes have anchoring brackets for additional support
- Sections easily bolt together for continuous runs
- Steel grates held in place with stainless steel clips and screws
- All drains coated inside and out with red corrosion-resistant paint
- Tees, Els, and Jays available for corner applications
- Lower cost alternative to non-metallic drains

- Standard Lengths:  
6" Wide - 1', 4', 5', and 6'  
8" Wide - 4', 5', and 6'  
12" Wide - 4', 5', and 6'

- Skid Quantities:  
6"-4' and 5' – 49 pieces  
6"-6' – 35 pieces  
8"-4' – 25 pieces  
12"-4' – 15 pieces

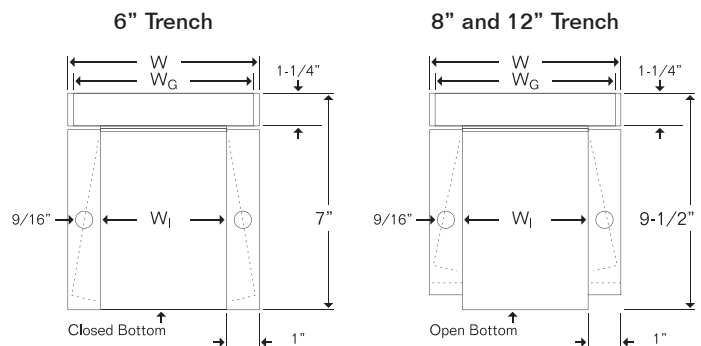

Product Widths	Trench Sizes		
	6"	8"	12"
Top (W)	6-1/2"	8-1/4"	12-1/4"
Grate (W <sub>G</sub> )	5-7/8"	7-7/8"	11-7/8"
Box (W <sub>I</sub> )	4-1/2"	6-1/4"	10-1/4"



# Trench Drain



## Cast Grate



6" Width

6TDCG



8" and 12"  
Widths

8TDCG  
12TDCG

Model	Size	Description	Weight (#)
6TDCG	6"	Steel Bottom w/ Ductile Iron Grate	14.8/Ft.
6TDB	6"	Steel Bottom Box Only	5.0/Ft.
6CG2-1	6"	Ductile Iron Grate Only – 2 Ft. Sec.	19.4
6EPS	6"	Steel End Plate – Solid	1.0
6EPSWH	6"	Steel End Plate w/ 4-1/4" Hole	0.9
8TDCG	8"	Open Bottom w/ Ductile Iron Grate	21.5/Ft.
8TDB	8"	Open Bottom Box Only	6.3/Ft.
8CGD2	8"	Ductile Iron Grate – 2 Ft. Sec.	30.4
8EPS	8"	Steel End Plate – Solid	2.0
8EPSWH	8"	Steel End Plate w/ 4-1/4" Hole	1.5
12TDCG	12"	Open Bottom w/ Ductile Iron Grate	28.9/Ft.
12TDB	12"	Open Bottom Box Only	6.5/Ft.
12CGD2	12"	Ductile Iron Grate – 2 Ft. Sec.	44.8
12EPS	12"	Steel End Plate – Solid	2.6
12EPSWH	12"	Steel End Plate w/ 4-1/4" Hole	2.4

- Greater load capacity for commercial and industrial applications
  - 6", 8", and 12" grate made of heavy duty ductile iron
  - Grates fit easily in boxes and require no tools to install
  - Grates shipped loose for on-site installation
  - All grates are manufactured in 2' lengths
  - Coated with black corrosion-resistant paint
- Standard Lengths:
- 6" Wide - 4', 5', and 6'
  - 8" Wide - 4', 5', and 6'
  - 12" Wide - 4', 5', and 6'

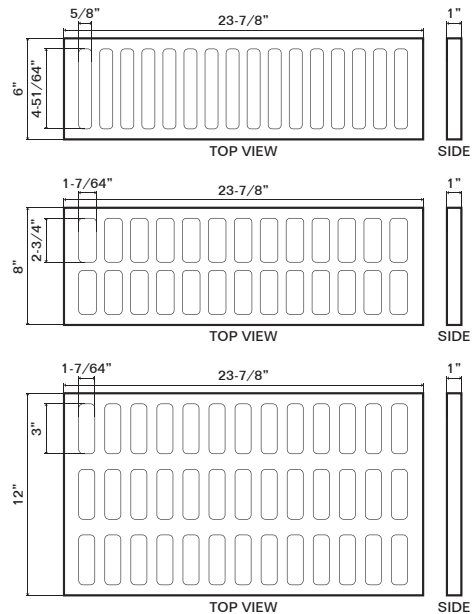

# Trench Drain Load Capacities & Flow Rates

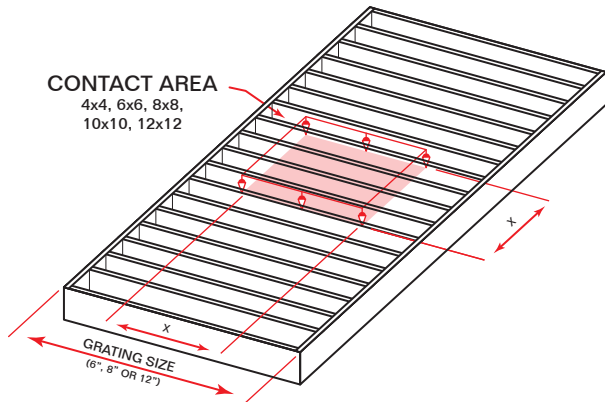

Welded Grating

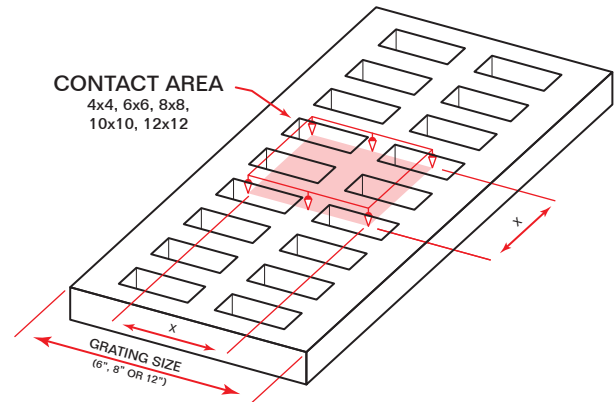

Cast Grating

Grating Size	Maximum Allowable Load in pounds based on load contact area <sup>1,2</sup>									
	4-inch x 4-inch		6-inch x 6-inch		8-inch x 8-inch		10-inch x 10-inch		12-inch x 12-inch	
	Welded	Cast	Welded	Cast	Welded	Cast	Welded	Cast	Welded	Cast
6-inch	6,400	9,600	12,800	21,400	22,800	40,000	35,700	57,100	51,400	85,700
8-inch	4,200	12,800	7,700	21,500	12,800	34,600	20,000	48,000	28,900	69,200
12-inch	2,500	7,600	4,200	11,900	6,400	17,300	9,100	21,900	12,800	30,700

1. Load values indicated include a 30% impact factor.
2. Loads are assumed to be evenly distributed over contact area indicated.
3. Shaded values indicate load areas that are larger than the grating size. In these cases, loads values represent the total load carried by the grating and surrounding pavement.
4. In addition to load values noted above, all grating types and sizes are rated for:
  - a. Standard AASHTO H20/HS20 truck loading.
  - b. Pneumatic tires inflated to 70 pounds per square inch or less.
5. Trench drains must be continuously supported and encased on both sides and bottom with 4" of 3,000 psi concrete to achieve load ratings indicated.

## Cast Iron Grating for Heavy Duty Applications

- Improved performance when subjected to hard wheel traffic such as pallet carts and forklifts.
- Improved performance in commercial and industrial applications.
- Lasts three times longer than welded grating when in similar environmental conditions.

## Approximate Flow Rate (based on 1% slope)

- 6" trench – 6.5 gallons per second
- 8" trench – 15.7 gallons per second
- 12" trench – 32.4 gallons per second



# Angle Lintels



Rolled Steel | Painted and Hot Dipped Galvanized

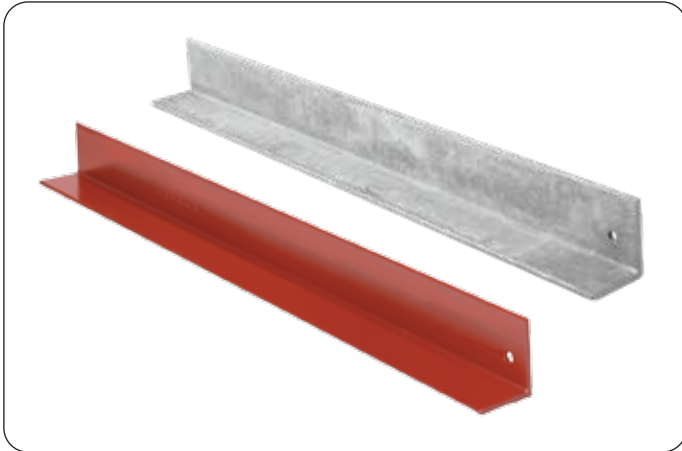

- Made from prime mill angles, full corner fillet rolled in
- Angles 120" and under are coated with red corrosion-resistant paint
- Most popular lengths of 3-1/2" x 3", and 5" x 3-1/2" are available in galvanized
- All lintels should be shored until mortar has cured

MODEL NUMBERS					
Size	3" x 3" x 3/16"	3-1/2" x 3" x 1/4"	3-1/2" x 3-1/2" x 1/4"	4" x 3" x 1/4"	5" x 3-1/2" x 5/16"
Wt. per ft. (#)	3.7	5.4	5.8	5.8	8.7
Length					
24"	RA3324	RA35324	RA353524	RA4324	RA53524
30"	RA3330	RA35330	RA353530	RA4330	RA53530
36"	RA3336	RA35336	RA353536	RA4336	RA53536
42"	RA3342	RA35342	RA353542	RA4342	RA53542
48"	RA3348	RA35348	RA353548	RA4348	RA53548
54"	RA3354	RA35354	RA353554	RA4354	RA53554
60"	RA3360	RA35360	RA353560	RA4360	RA53560
66"	RA3366	RA35366	RA353566	RA4366	RA53566
72"	RA3372	RA35372	RA353572	RA4372	RA53572
78"	RA3378	RA35378	RA353578	RA4378	RA53578
84"	RA3384	RA35384	RA353584	RA4384	RA53584
90"	RA3390	RA35390	RA353590	RA4390	RA53590
96"	RA3396	RA35396	RA353596	RA4396	RA53596
102"	RA33102	RA353102	RA3535102	RA43102	RA535102
108"	RA33108	RA353108	RA3535108	RA43108	RA535108
114"	RA33114	RA353114	RA3535114	RA43114	RA535114
120"	RA33120	RA353120	RA3535120	RA43120	RA535120
*126"	RA33126	RA353126	RA3535126	RA43126	RA535126
*132"	RA33132	RA353132	RA3535132	RA43132	RA535132
*144"	RA33144	RA353144	RA3535144	RA43144	RA535144
*20-Ft.	RA3320	RA35320	RA353520	RA4320	RA53520
Special Lengths, Per Ft.	RA33SL	RA353SL	RA3535SL	RA43SL	RA535SL

\*Angles over 120" are unpainted





# Brick Lintels



## Pressed Steel



- Unique forming process develops high cross-sectional strength
- Ample load-bearing capacity, stiff in service, and free from sagging or buckling
- All lintels should be shored until mortar has cured
- Coated with red corrosion-resistant paint

Model	Dimensions	Weight (#)
BRK18	18" x 3-1/2" x 3-1/2" x 12GA	3.8
BRK24	24" x 3-1/2" x 3-1/2" x 12GA	5.1
BRK30	30" x 3-1/2" x 3-1/2" x 12GA	6.4
BRK36	36" x 3-1/2" x 3-1/2" x 12GA	7.7
BRK42	42" x 3-1/2" x 3-1/2" x 12GA	8.9
BRK48	48" x 3-1/2" x 3-1/2" x 12GA	10.2
BRK54	54" x 3-1/2" x 3-1/2" x 12GA	11.4
BRK60	60" x 4-1/2" x 3-1/2" x 12GA	14.0
BRK66	66" x 4-1/2" x 3-1/2" x 10GA	20.5
BRK72	72" x 4-1/2" x 3-1/2" x 10GA	22.5
BRK78	78" x 4-1/2" x 3-1/2" x 10GA	23.4
BRK84	84" x 4-1/2" x 3-1/2" x 10GA	25.3
BRK90	90" x 4-1/2" x 3-1/2" x 10GA	27.2
BRK96	96" x 4-1/2" x 3-1/2" x 10GA	29.1
BRK102	102" x 4-1/2" x 3-1/2" x 10GA	31.0
FVL	Foundation Vent Lintels 3" x 20" (25 Per Bundle)	1.5
FVLG	Foundation Vent Lintels, Galv. 3" x 20" (25 Per Bundle)	1.5

# Block Lintels



## Pressed Steel

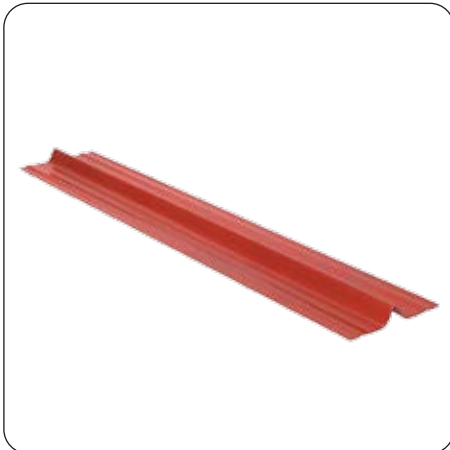

- Unique forming process develops high cross-sectional strength
- Ample load-bearing capacity, stiff in service, and free from sagging or buckling
- All lintels should be shored until mortar has cured
- Coated with red corrosion-resistant paint

6" BLOCK LINTELS		
Model	Dimensions	Weight (#)
BLK630	30" x 5" x 12GA	5.5
BLK636	36" x 5" x 12GA	6.5
BLK642	42" x 5" x 12GA	7.6
BLK648	48" x 5" x 12GA	8.7
BLK654	54" x 5" x 12GA	9.9
BLK660	60" x 5" x 12GA	10.9

8" BLOCK LINTELS		
Model	Dimensions	Weight (#)
BLK824	24" x 7" x 12GA	6.1
BLK830	30" x 7" x 12GA	7.4
BLK836	36" x 7" x 12GA	8.6
BLK842	42" x 7" x 12GA	10.0
BLK848	48" x 7" x 12GA	11.4
BLK854	54" x 7" x 12GA	12.7
BLK860	60" x 7" x 12GA	14.0
BLK866	66" x 7" x 10GA	20.5
BLK872	72" x 7" x 10GA	22.5
BLK878	78" x 7" x 10GA	23.4
BLK884	84" x 7" x 10GA	25.3

10" BLOCK LINTELS		
Model	Dimensions	Weight (#)
BLK1036	36" x 9" x 12GA	11.3
BLK1042	42" x 9" x 12GA	13.1
BLK1048	48" x 9" x 12GA	15.0
BLK1054	54" x 9" x 12GA	17.6
BLK1060	60" x 9" x 12GA	19.6

12" BLOCK LINTELS		
Model	Dimensions	Weight (#)
BLK1236	36" x 11" x 12GA	14.0
BLK1242	42" x 11" x 12GA	16.3
BLK1248	48" x 11" x 12GA	18.6
BLK1254	54" x 11" x 12GA	20.9
BLK1260	60" x 11" x 12GA	23.2



# Anchor Bolts

Plain and Galvanized



Model Plain	Bolt Diameter	Bolt Length	Weight/ Carton (#)	Pieces/ Carton
AB126	1/2"	6"	18	50
AB128	1/2"	8"	22	50
AB1210	1/2"	10"	26	50
AB1212	1/2"	12"	30	50
AB1214	1/2"	14"	34	50
AB1216	1/2"	16"	38	50
AB1218	1/2"	18"	42	50
Model Galvanized	Bolt Diameter	Bolt Length	Weight Carton(#)	Pieces/ Carton
ABG126	1/2"	6"	19.5	50
ABG128	1/2"	8"	24.0	50
ABG1210	1/2"	10"	28.5	50
ABG1212	1/2"	12"	33.0	50
ABG1214	1/2"	14"	38.0	50
ABG1216	1/2"	16"	42.5	50
ABG1218	1/2"	18"	47.0	50

# Foundation Anchors



• 5/8", 3/4" and 1" diameters available upon request.

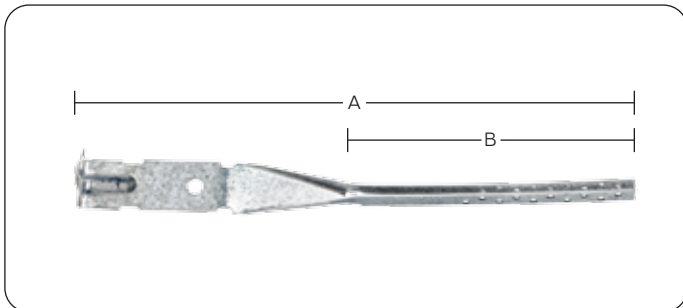

Model	Gauge	Description A	Description B	Weight/ Carton(#)	Pieces/ Carton
FA-14Z	18 Gauge Galvanized	13-1/4"	6-3/4"	12.0	50
FA-22Z	18 Gauge Galvanized	21-1/2"	6-3/4"	18.3	50

Shipped: Per Carton

- For use with concrete or masonry foundation walls  
Does away with plate drilling to anchor mud sills to foundation
- For use with 2" x 4" and 2" x 6" sill plates
- Meets building codes for corrosion resistance
- Standard Pallet Quantities:  
FA-14Z – 150 cartons per pallet  
FA-22Z – 100 cartons per pallet

# Wall Ties

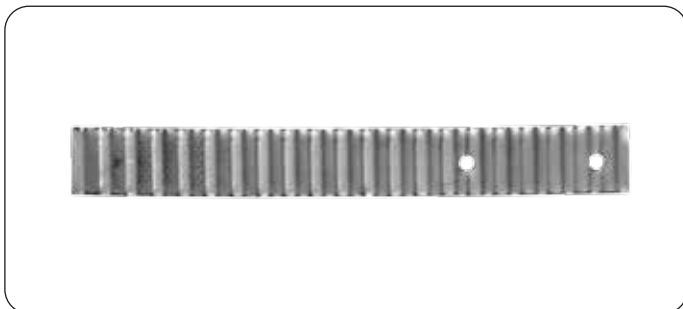

Model	Gauge	Minimum Size	Weight/ Carton(#)	Pieces/ Carton
WT28	28	7/8" x 7"	29.0	1,000 (loose)
WT285	28	7/8" x 7"	14.5	500 (loose)
WT22	22	7/8" x 7"	28.0	500 (loose)

100 Cartons Per Pallet; Uniform Gauge

- Galvanized steel
- Corrugated
- Approximate piece count, by weight
- Packed in sturdy individual cartons



# Foundation Access Doors



## Crawl Space Doors



- Heavy gauge steel; all welded construction
- Built-in 3" lintel
- Positive latch
- Made to accept padlock
- Coated with red corrosion-resistant paint

Model	Size	Weight (#)	Pieces/Pallet
AD2416	24" x 16"	13.8	72
AD2424	24" x 24"	16.5	36
AD3216	32" x 16"	16.0	64
AD3220	32" x 20"	19.0	32
AD3224	32" x 24"	20.5	32
AD3232	32" x 32"	23.0	32
AD3240	32" x 40"	31.0	32
AD3624	36" x 24"	25.0	28

# Foundation Ventilators

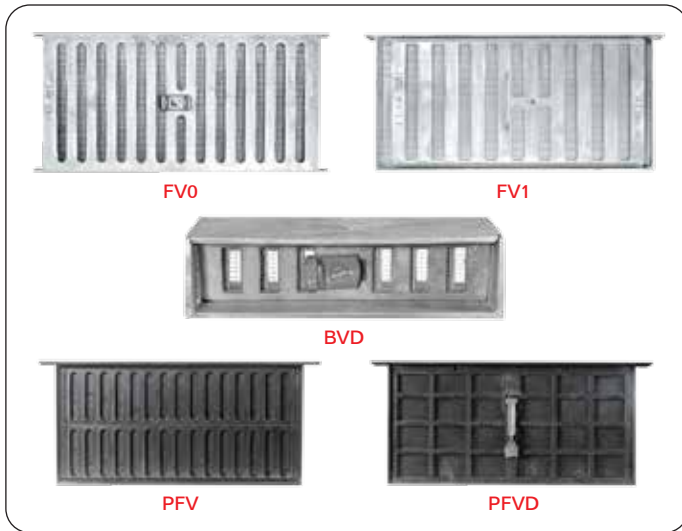

### BLOCK GRILLE TYPE | CAST ALUMINUM | PLASTIC

Model	Size	Description	Weight/ Carton(#)	Pieces/ Carton
FV0	8" x 16"	Aluminum – Slider Style	30	12
FV1	8" x 16"	Aluminum – Slider Style	33	12
PFV	8" x 16"	Plastic – Slider Style	17	12
PFVD	8" x 16"	Plastic – Damper Style	17	12

Shipped: Per Carton

- Adjustable grille
- Aluminum screen

### BRICK RECESSED SHUTTER TYPE | CAST ALUMINUM

Model	Size	Description	Weight/ Carton(#)	Pieces/ Carton
BVD	2" x 8"	Single Brick Height	37	24

Shipped: Per Carton

- Aluminum screen
- Adjustable shutter regulates air flow
- Recessed design protects against rain

# Steel Stakes



ROUND W/HOLES (NS)

- Steel stakes don't splinter or split like wood stakes
- Steel stakes drive and pull easier than wood stakes
- Steel stakes outlast wood stakes, many times over
- Steel stakes are ready to use; no cutting

Model	Size	Weight/ Carton (#)	Pieces/ Carton
NS3418	3/4" x 18"	22.5	10
NS3424	3/4" x 24"	30.0	10
NS3430	3/4" x 30"	37.5	10
NS3436	3/4" x 36"	45.0	10

Shipped: Per Carton



# Chimney Caps



## Traditional Size Bolt-On Covers for Masonry Chimneys



**BLACK GALVANIZED**



**STAINLESS STEEL**

- 24 gauge single piece galvanized steel hood
- 14 gauge galvanized steel base for extreme strength
- 18 gauge – 3/4" expanded galvanized steel mesh
- Attractive black powder coated finish
- Slotted hex-head bolts included
- Custom sizes available
- 7 year warranty

- 100% 304 stainless steel
- 24 gauge single piece stainless steel hood
- 16 gauge stainless steel base for extreme strength
- 18 gauge – 3/4" expanded galvanized steel mesh
- Slotted hex-head stainless steel bolts included
- Custom sizes available
- Lifetime warranty

Model	Outside Tile Size	Fits Outside Dimensions	Finish	Weight (#)	Pieces/ Carton
CBO99	9" x 9"	7-1/2" x 7-1/2" to 9-1/2" x 9-1/2"	Galv.-Ptd. Blk.	7.0	1
CBO913	9" x 13"	7-1/2" x 11-1/2" to 9-1/2" x 13-1/2"	Galv.-Ptd. Blk.	8.0	1
CBO918	9" x 18"	7-1/2" x 16-1/2" to 9-1/4" x 18-1/4"	Galv.-Ptd. Blk.	10.0	1
CBO1313	13" x 13"	11-1/2" x 11-1/2" to 13-1/2" x 13-1/2"	Galv.-Ptd. Blk.	10.0	1
CBO1318	13" x 18"	11-1/2" x 16-1/2" to 13-1/4" x 18-1/4"	Galv.-Ptd. Blk.	12.0	1
CBO1818	18" x 18"	16-1/2" x 16-1/2" to 18" x 18"	Galv.-Ptd. Blk.	14.5	1
SS99	9" x 9"	7-1/2" x 7-1/2" to 9-1/2" x 9-1/2"	304 Stainless	6.5	1
SS913	9" x 13"	7-1/2" x 11-1/2" to 9-1/2" x 13-1/2"	304 Stainless	8.0	1
SS918	9" x 18"	7-1/2" x 16-1/2" to 9-1/4" x 18-1/4"	304 Stainless	9.0	1
SS1313	13" x 13"	11-1/2" x 11-1/2" to 13-1/2" x 13-1/2"	304 Stainless	9.5	1
SS1318	13" x 18"	11-1/2" x 16-1/2" to 13-1/4" x 18-1/4"	304 Stainless	11.0	1
SS1818	18" x 18"	16-1/2" x 16-1/2" to 18" x 18"	304 Stainless	13.0	1

# Leg Kit

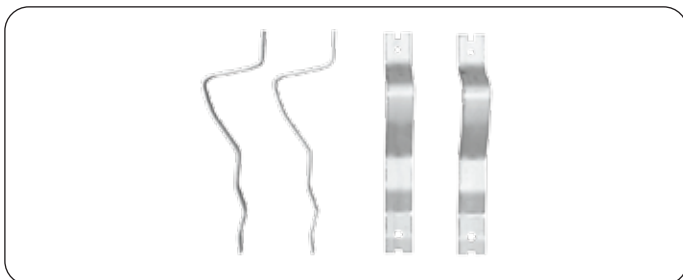

Model	Fits Sizes	Finish	Weight/ Carton(#)	Pieces/ Carton
LK4-SS	Any Size Cap	304 Stainless	1.5	24



## Fireplace Dampers

Cast Iron



Model	Throat Dimensions			Weight (#)
	Front	Back	Depth	
CD24	24"	16"	10"	28
CD30	30"	22"	10"	37
CD33	33"	25"	10"	42
CD36	36"	28"	10"	47
CD42	42"	34"	10"	56
CD48	48"	40"	10"	65

## Damper Controls

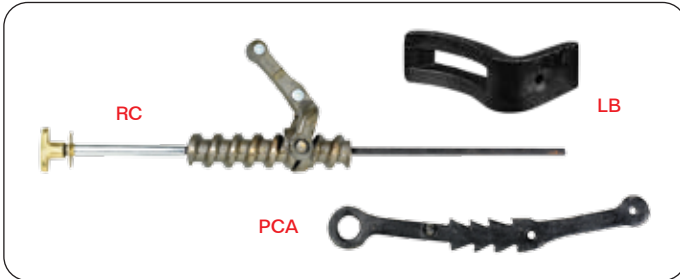

- Complete with cast iron valve plate and 5 position poker control detached and bolted to body
- Most commonly used standard fireplace damper design
- Coated with black corrosion-resistant paint

Model	Description	Weight (#)
RC	Rotary Control – 10" Throat	3
PCA	Poker Control – 10" Throat	1
LB	L-Bracket f/Poker Control	1

## Cleanout Doors

Cast Iron and Steel

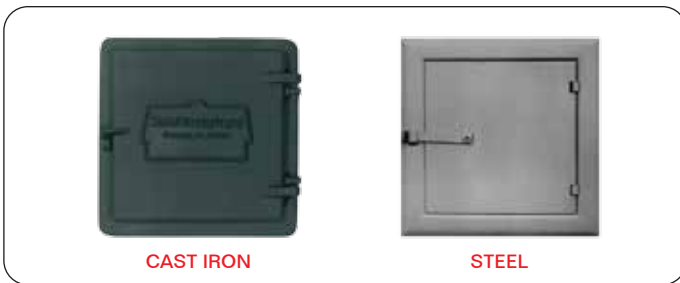

Model	Door Opening	Description	Weight/ Carton(#)	Pieces/ Carton
CCD88	8" x 8"	Cast Iron – Imp.	48	6
CCD810	8" x 10"	Cast Iron – Imp.	66	6
CCD812	8" x 12"	Cast Iron – Imp.	68	6
SCD88	8" x 8"	Steel – Dom.	15	6

Shipped: Per Carton

## Ash Dumps

Cast Iron

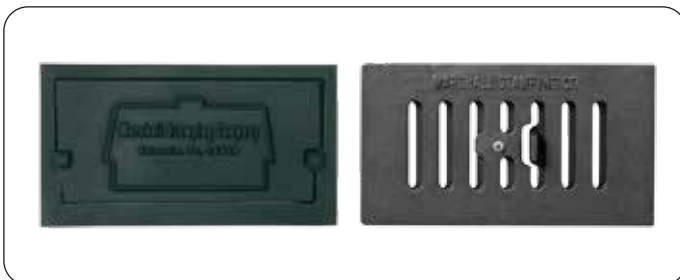

Model	Size Opening	Description	Weight/ Carton(#)	Pieces/ Carton
AD459	4-1/2" x 9"	Cast Iron – Imp.	36	12
AD459V	4-1/2" x 9"	Cast Iron – Vented	48	12

Shipped: Per Carton



# Bar Strainers

Cast Iron



Model	Pipe Size	Weight (#)
BS10	10"	10.7
BS12	12"	15.5
BS15	15"	25.0
BS6J	6" Oversize	5.0
BS8J	8" Oversize	7.5
BS10J	10" Oversize	12.0
BS12J	12" Oversize	14.8
BS15J	15" Oversize	29.5

Shipped: Loose

- Coated with black corrosion-resistant paint

# Mortar Boxes



Model	Outside Top Length	Dimensions Width	Depth	Weight (#)	Capacity (Cu. Ft.)
MB0	50"	27"	10"	52	6.0
MB1	63"	34"	10"	68	9.0
MB15	75"	39"	10"	98	13.5

Shipped: Nested (no jamming)

- Formed from single, heavy gauge steel sheet
- All welded construction
- Coated with red corrosion-resistant paint

# Brick Clamps



Model	Adjustable	Weight/ Carton (#)	Pieces/ Carton
BC	16" to 26" (7 to 10 bricks)	48	12

- Established product; widespread industry acceptance
- Welded steel construction
- Coated with yellow enamel
- Packaged in individual sturdy cartons







