



MAGIC
P L A S T I C S

THE RELIABLE SOURCE
SINCE 1985

2020

TABLE OF CONTENTS

“Smart” Check® Valves	4-5
Retro “Smart” Check® Valves	5
Metric “Smart” Check® Valves	6
Hose Clamp “Smart” Check® Valves	6
Slide-Check & Ball-Check Combo Valves	6
“CR2®” Corrosion Resistant Check Valves	7
Check Valve Replacement Components	7
Utility Molded In Place (MIP) Ball Valves	8
Uni-Body Valves	8-10
Metric Uni-Body Valves	10
Spa On/Off Valves	11
Spa Drain Valves	11
Compact Air Check Valves	12
MagicVac	12
90° Sweeps	13
Spa Components and White Goods	13
Manifolds	14
MagicMend® Pipe Extenders (Schedule 40)	15
MagicMend® Pipe Extenders (CL 200)	15
MagicMend® Extender Fittings	15
MagicMend® Insider Connectors	16
Copper-To-PVC Adapters	16
Heater-Pump Adapters	16
Union Assemblies	17
High Heat Union Assemblies	17-18
Union Components	18
Snap Nuts	19
Heater Union Components	19
Three-Piece Valves	20
Tank Adapter Valves	20
Specialty Products	21
Hose Bibbs	22
PVC Industrial Unions	22
Expandable Repair Couplings	23
Compression Couplings	23
O-Rings	24
Washer Rings	24
Magic Wrench	24
Replacement Components	25
I.B.C. (Intermediate Bulk Container) Products	26

“Smart” Check® Valves

The “Smart” Check® provides you with reliable back-flow prevention without the inline restriction of a conventional check valve. With the use of high powered magnets, the “Smart” Check valve remains in the closed position to 2 PSI, opening fully when 2 lb. line pressure is exceeded. The “Smart” Check has a Spring-Loaded gate mechanism allowing the valve to be installed in any orientation. The valve is also available in a non-magnetic, ½ lb. Spring-Loaded version.

Available in ½” through 3” IPS sizes. The “Smart” Check Valves are rated at 150 PSI at 73°F. All “Smart” Check Valves are also available as a Swing-Check, without Spring. Minimum order quantities apply. Please contact the factory direct for details.



PART NUMBER	SIZE & DETAIL DESCRIPTION	SPRING TENSION	IPS SIZE	QTY CASE	WT CASE
0821-05	½” Slip x Slip	½ lb.	½”	12	5
0821-05C	½” Slip x Slip Clear	½ lb.	½”	12	5
0826-05	½” FIPT x FIPT	½ lb.	½”	12	5
0826-05C	½” FIPT x FIPT Clear	½ lb.	½”	12	5
0821-07	¾” Slip x Slip	½ lb.	¾”	12	5
0821-07C	¾” Slip x Slip Clear	½ lb.	¾”	12	5
0826-07	¾” FIPT x FIPT	½ lb.	¾”	12	5
0826-07C	¾” FIPT x FIPT Clear	½ lb.	¾”	12	5
0821-10	1” Slip x Slip	½ lb.	1”	12	8
0821-10C	1” Slip x Slip Clear	½ lb.	1”	12	8
0821-15	1½” Slip x Slip	½ lb.	1 ½”	12	9
0821-15C	1½” Slip x Slip Clear	½ lb.	1 ½”	12	9
0821-20	2” Slip x Slip	½ lb.	2”	12	13
0821-20C	2” Slip x Slip Clear	½ lb.	2”	12	13
0821-20M	2” Slip x Slip w/Magnet	2 lb.	2”	12	14
0821-20MC	2” Slip x Slip w/Magnet Clear	2 lb.	2”	12	14
0821-30	3” Slip x Slip	½ lb.	3”	8	22
0821-30C	3” Slip x Slip Clear	½ lb.	3”	8	22



0822-20	2” Spigot x Slip	½ lb.	2”	12	13
0822-20C	2” Spigot x Slip Clear	½ lb.	2”	12	13
0822-20M	2” Spigot x Slip w/Magnet	2 lb.	2”	12	14
0822-20MC	2” Spigot x Slip w/Magnet Clear	2 lb.	2”	12	14

“Smart” Check® Valves

WIDE PROOF



WIDE PROOF



WIDE PROOF



PART NUMBER	SIZE & DETAIL DESCRIPTION	SPRING TENSION	IPS SIZE	QTY CASE	WT CASE
0823-10	1" Union x Union	½ lb.	1"	12	10
0823-10C	1" Union x Union Clear	½ lb.	1"	12	10
0823-12	1¼" Union x Union	½ lb.	1¼"	12	11
0823-12C	1¼" Union x Union Clear	½ lb.	1¼"	12	11
0823-15	1½" Union x Union	½ lb.	1½"	12	13
0823-15C	1½" Union x Union Clear	½ lb.	1½"	12	13
0823-20	2" Union x Union	½ lb.	2"	12	25
0823-20C	2" Union x Union Clear	½ lb.	2"	12	25
0823-20M	2" Union x Union w/Magnet	2 lb.	2"	12	26
0823-20MC	2" Union x Union w/Magnet Clear	2 lb.	2"	12	26

0824-20	2" Spigot x Union	½ lb.	2"	12	20
0824-20C	2" Spigot x Union Clear	½ lb.	2"	12	20
0824-20M	2" Spigot x Union w/Magnet	2 lb.	2"	12	21
0824-20MC	2" Spigot x Union w/Magnet Clear	2 lb.	2"	12	21

0825-15	1½" Slip x Union	½ lb.	1½"	12	11
0825-15C	1½" Slip x Union Clear	½ lb.	1½"	12	11
0825-20	2" Slip x Union	½ lb.	2"	12	20
0825-20C	2" Slip x Union Clear	½ lb.	2"	12	20
0825-20M	2" Slip x Union w/Magnet	2 lb.	2"	12	21
0825-20MC	2" Slip x Union w/Magnet Clear	2 lb.	2"	12	21

Retro “Smart” Check® Valves

Switch out and upgrade old style restrictive Center-Poppet Spring or old style Swing Check Acme Threaded valves with Magic Plastics' Retro Replacement Smart Check® Valve Bodies. There is no longer a need to purchase the entire valve assembly and discard the Union Fittings. Magic's Retro is sold separately as a replacement body in 1½" and 2" sizes. Most importantly, you get the same Full-Flow design as Magic Plastics' innovative and popular Smart Check® Valves. The light ½ lb. spring allows you to install the valve in any orientation while still achieving a 100% Full-Flow opening.



PART NUMBER	SIZE & DETAIL DESCRIPTION	SPRING TENSION	IPS SIZE	QTY CASE	WT CASE
0823-15RT	1½" Union x 1½" Union Retro Ck. Valve	½ lb.	1½"	12	10
0823-15RTC	1½" Union x 1½" Union Retro Ck. Valve Clear	½ lb.	1½"	12	10
0823-20RT	2" Union x 2" Union Retro Check Valve	½ lb.	2"	12	14
0823-20RTC	2" Union x 2" Union Retro Ck. Valve Clear	½ lb.	2"	12	14

Unions not included.

Metric “Smart” Check® Valves

WATERPROOF



PART NUMBER	SIZE & DETAIL DESCRIPTION	SPRING TENSION	IPS SIZE	QTY CASE	WT CASE
M823-15	50MM Union x Union	½ lb.	50mm	12	13
M823-15C	50MM Union x Union Clear	½ lb.	50mm	12	13
M823-20	63MM Union x Union	½ lb.	63mm	12	25
M823-20C	63MM Union x Union Clear	½ lb.	63mm	12	25

Hose Clamp Check Valves

Simplify your installation with Magic Plastics’ Hose Clamp Check Valves. There is no need to solvent weld, just secure the Hose Clamps with a screwdriver. The innovative design of the Smart Check® Valve will eliminate water hammer noise and also allows you to install the valve in any orientation. This is the perfect valve for DIYs! All materials used to manufacture the valves meet ASTM standards. Available in 1½” and 2” sizes in White and Clear PVC.



PART NUMBER	SIZE & DETAIL DESCRIPTION	SPRING TENSION	IPS SIZE	QTY CASE	WT CASE
0821-15H	1½” Slip x 1½” Slip Hose Clamp Check Valve	½ lb.	1½”	12	14
0821-15HC	1½” Slip x 1½” Slip Hose Clamp Ck. Valve Clear	½ lb.	1½”	12	14
0821-20H	2” Slip x 2” Slip Hose Clamp Check Valve	½ lb.	2”	12	26
0821-20HC	2” Slip x 2” Slip Hose Clamp Ck. Valve Clear	½ lb.	2”	12	26

Slide-Check & Ball-Check Combo Valves

Magic Plastics’ compact Slide-Check and Ball-Check Combo Valves combine the Valve and a “Smart” Check Valve in the same unit; saving you both excess time and labor during installation. The design of the “Smart” Check Valve will eliminate water hammer noise while also providing you with the luxury of installing the valve in either orientation, horizontally or vertically. Easy connection Buttress Thread Unions allow for cleaning of both valves when necessary. Slide-Check Combo Valves come equipped with the MagicSnap External Valve Lock to prevent accidental closure. All Slide-Check and Ball-Check Combo Valves are made from PVC and meet ASTM standards. Available in 1½” and 2” Slip configurations.

WATERPROOF



Slide-Check



Ball-Check

PART NUMBER	SIZE & DETAIL DESCRIPTION	QTY CASE	WT CASE
0850-15	1½” Slip x Slip Slide-Check Combo Valve	12	24
0850-15C	1½” Slip x Slip Slide-Check Combo Valve Clear	12	24
0850-20	2” Slip x Slip Slide-Check Combo Valve	12	36
0850-20C	2” Slip x Slip Slide-Check Combo Valve Clear	12	36
0860-15	1½” Slip x Slip Ball-Check Combo Valve	12	28
0860-15C	1½” Slip x Slip Ball-Check Combo Valve Clear	12	28
0860-20	2” Slip x Slip Ball-Check Combo Valve	12	42
0860-20C	2” Slip x Slip Ball-Check Combo Valve Clear	12	42

“CR2®” Corrosion Resistant Check Valves

The “CR2®” Back-Flow prevention check valve is completely corrosion resistant, making it the ultimate solution for protecting your expensive Heat Exchangers from the potential damage of inline Chlorinators while also maintaining a Full-Flow circulation system. Numerous features are included with the “CR2®” Valve including a proprietary designed Hastelloy® Spring, Glass-Filled Noryl injection molded shaft, 100% Silicone Gasket and a Clear, serviceable lid. The “CR2®” Valve is also equipped with a ½ lb. spring-loaded gate, allowing it to be installed in any orientation. The “CR2®” valve is available in 1½” Slip, 2” Slip and 2½” Spigot. Economy version without Hastelloy® Spring available.



PART NUMBER	PART DESCRIPTION	IPS SIZE	QTY CASE	WT CASE
0801-20H2	CPVC	2”	12	14

Economy Valve

0801-20	ECONOMY	2”	12	14
----------------	---------	----	----	----

0801-20 Not Equipped with Hastelloy® Spring

PART NUMBER	SIZE & DETAIL DESCRIPTION	QTY CASE
0060104028	Adapter, 2” Spigot x 1½” Slip White	24
0061304028	Adapter, 2” Spigot x 1½” Slip Black	24

*1½” Bushings Sold Separately.

Check Valve Replacement Components

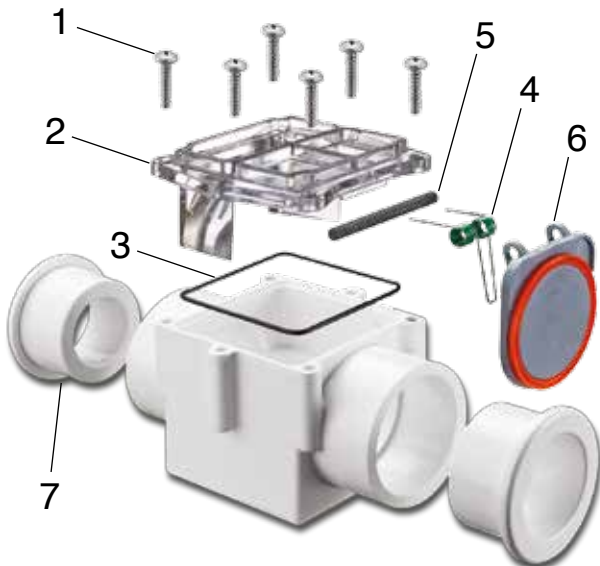

ID	PART NUMBER	SIZE & DETAIL DESCRIPTION	PKG QTY
1	0403-006-6	#14 x 1” Phillips Pan Head Stainless Metal Screw	6
2	0191401020	Lid, 2” Swing-Spring Check Valve	1
3	0301-154	O-Ring, 2” Swing-Spring Check Valve	1
4	0405-001	Spring, 2” Swing-Spring Check Valve	1
4	0405-001-H	Hastelloy Spring	1
5	0401-005P	Shaft, 2” Swing-Spring Check Valve	1
6	0081201020	Gate Assembly, 2” Swing-Spring Check Valve	1
7	0060104028	Adapter, 2” Spigot x 1½” Slip White	1
7	0061304028	Adapter, 2” Spigot x 1½” Slip Black	1
RK	0801-20H-RK	Replacement Kit, Check Valve Contains ID# 2, 3, 4(H), 5 & 6	1

Utility Molded-In-Place Ball Valves

Specifically designed for Residential, Commercial and Industrial applications, the Magic MIP Ball Valves are equipped with EPDM Seats and O-Rings, providing smooth operation and excellent chemical resistance. All Valves comply with ASTM 2467 Standards and operate at a working pressure of 150 PSI at 73°F. Magic MIP Ball Valves are available in ½" through 3" Slip x Slip configurations.

Threaded configurations and larger sizes (4", 6" and 8") are available upon request. Minimum order quantities apply. Please contact the factory direct for details.



PART NUMBER	SIZE & DETAIL DESCRIPTION	QTY CASE	WT CASE
0250-05	½" Slip x Slip Ball Valve	36	6
0250-07	¾" Slip x Slip Ball Valve	18	5
0250-10	1" Slip x Slip Ball Valve	25	11
0250-15	1½" Slip x Slip Ball Valve	12	12
0250-20	2" Slip x Slip Ball Valve	8	11
0250-25	2½" Slip x Slip Ball Valve	6	25
0250-30	3" Slip x Slip Ball Valve	6	26

Uni-Body Valves

The innovative patented design of the Magic Uni-Body valve was engineered for use in a wide variety of industries and applications. The built in Snap-Lock guarantees zero flow restriction during operation while the Cam-Lock function provides a 100% positive seal when shutoff is required. We have also added a specially formulated dry lubricant to our Seals and then overmold them directly to the valve gate, eliminating the need to repair or replace the gate seals. The Magic Uni-Body valve is available in a variety of configurations in 1", 1½", 2" and 2½" IPS sizes.



PART NUMBER	IPS SIZE	QTY CASE/ MASTER	WT CASE/ MASTER
0401-10	1"	14/56	8/34
0401-15	1½"	14/56	9/36
0401-20	2"	12/48	10/41
0401-25	2½"	5/20	8/33

Slip x Slip



PART NUMBER	IPS SIZE	QTY CASE/ MASTER	WT CASE/ MASTER
0501-15	1½"	6/24	7/28
0501-20	2"	6/24	10/41

Slip Union x Slip Union

WIDEPROOF

Uni-Body Valves



Slip x Spigot

PART NUMBER	IPS SIZE	QTY CASE/ MASTER	WT CASE/ MASTER
0412-15	1½"	14/56	8/33
0412-20	2"	12/48	10/39
0412-25	2½"	5/20	8/30



Spigot x Spigot

PART NUMBER	IPS SIZE	QTY CASE/ MASTER	WT CASE/ MASTER
0402-15	1½"	14/56	7/30
0402-20	2"	12/48	9/37
0402-25	2½"	5/20	8/30



Slip x Union

PART NUMBER	IPS SIZE	QTY CASE/ MASTER	WT CASE/ MASTER
0516-15	1½"	10/40	9/36
0516-20	2"	10/40	12/49
0516-25	2½"	5/20	10/40

VIBROPROOF



Spigot x Slip Union

PART NUMBER	IPS SIZE	QTY CASE/ MASTER	WT CASE/ MASTER
0517-15	1½"	10/40	8/31
0517-20	2"	10/40	12/49
0517-25	2½"	5/20	10/39

VIBROPROOF



Slip x FIPT

PART NUMBER	IPS SIZE	QTY CASE/ MASTER	WT CASE/ MASTER
0414-15	1½"	14/56	9/36



Slip x MIPT

PART NUMBER	IPS SIZE	QTY CASE/ MASTER	WT CASE/ MASTER
0413-15	1½"	14/56	9/36



Spigot x FIPT

PART NUMBER	IPS SIZE	QTY CASE/ MASTER	WT CASE/ MASTER
0424-15	1½"	14/56	8/32



MIPT x MIPT

PART NUMBER	IPS SIZE	QTY CASE/ MASTER	WT CASE/ MASTER
0403-15	1½"	14/56	9/35



MIPT x FIPT

PART NUMBER	IPS SIZE	QTY CASE/ MASTER	WT CASE/ MASTER
0434-15	1½"	14/56	9/35
B434-15	1½"	14/56	9/35

B434-15=BLACK

Uni-Body Valves



Slip x Swivel FBT

PART NUMBER	IPS SIZE	QTY CASE/ MASTER	WT CASE/ MASTER
0550-15	1½"	10/40	10/40
0550-20	2"	10/40	13/50

WIDEPROOF



Slip Union x MIPT

PART NUMBER	IPS SIZE	QTY CASE/ MASTER	WT CASE/ MASTER
0435-15	1½"	10/40	8/31

WIDEPROOF



Pool Hose x MIPT

PART NUMBER	IPS SIZE	QTY CASE/ MASTER	WT CASE/ MASTER
0423-15	1½"	14/56	8/32
B423-15	1½"	14/56	8/32

B423-15=BLACK



Slip x MBT w/Washer Ring

PART NUMBER	IPS SIZE	QTY CASE/ MASTER	WT CASE/ MASTER
0556-20	2"	12/48	11/38

Equipped with washer ring only.

Metric Uni-Body Valves



Slip x Slip

PART NUMBER	IPS SIZE	QTY CASE/ MASTER	WT CASE/ MASTER
M401-15	50MM	14/56	9/36
M401-20	63MM	12/48	10/41

Minimum order 500. This is not a stock item.

90° On/Off Valve

Magic Plastics' 90° On-Off Valve is the perfect valve for spa side operation of waterfalls, neck jets or just about any other water feature in the spa. Unlike other valves of this type, Magic's 90° On-Off valve is Full-Flow and requires only 3 full turns to open or close the valve.



0230-10	1"	48/96	20/40
----------------	----	-------	-------

*Custom cap colors and designs available.
Contact factory for details and minimum order requirements.*

Spa Drain Valves

Simplify your servicing needs with Magic Plastics' patented Drain Valve. Manufactured from impact modified ABS and equipped with a total of 5 Teflon Impregnated O-Rings, the Magic Drain Valve is accessible to the consumer and simple to use. Designed for Skirt or Kick-Plate installations, the Drain Valve is flush mounted to the wall and secured in the closed position.

To operate, pull the spout out, leaving the exterior end cap on. Once extracted, by design, the Drain Valve will stay in the closed position. After the garden hose is installed, push the spout back in halfway to actuate the drain. The valve is also equipped with a removable bezel in order for the skirt to be detached without disturbing the plumbing. The Magic Drain Valve also has built in freeze protection and will drain approximately 5 gallons per minute. Available in 1/2" Slip, 3/4" Barb or 3/4" Spigot configurations. For detailed illustrated instructions, visit our download center at www.magicplastics.com.



PART NUMBER	SIZE & DETAIL DESCRIPTION	QTY CASE
0455-05	1/2" Slip Spa Drain Valve	54
0456-05	3/4" Barbed Spa Drain Valve	54
0457-05	3/4" Spigot Spa Drain Valve	54

Compact Air Check Valves

Magic Plastics' Compact Air Check Valves are ideal for all Spa, Jetted Tub and Pool applications. The Air Check Valve is equipped with various spring tensions and a 100% Silicone Seal. The true compact design will save valuable space, providing a quiet and smooth operation virtually eliminating possible valve chatter during shutdown. Available in 1 1/2" Slip - 2" Spigot in PVC or Polycarbonate Clear for higher heat applications and improved clarity.



PART NUMBER	SIZE & DETAIL DESCRIPTION	PKG QTY
0830-15-025	1 1/2" Slip x 2" Spigot 1/4 lb. Compact Air Check Valve	45
0830-15-025C	1 1/2" Slip x 2" Spigot 1/4 lb. Compact Air Check Valve	45
0830-15-500C	1 1/2" Slip x 2" Spigot 5 lb. Compact Air Check Valve	45

MagicVac

The MagicVac is operated by placing your thumb over the ergonomic air hole located at the top of the Vac, submerging it near the area to be cleaned, then releasing your thumb. A rush of water and debris will fill the clear, UV stabilized chamber. Raise the full chamber above the water line and allow it to drain, away from the spa. Virtually all debris will remain trapped in the built in removable filter. Detach the End Cap with a simple quarter turn and empty the debris. The MagicVac picks up sand, pebbles, even small rocks. You will be able to reach areas in excess of seven feet away with the telescoping aluminum pole. The MagicVac is completely serviceable and weighs less than two pounds.



PART NUMBER	SIZE & DETAIL DESCRIPTION	QTY CASE
0690-1GEN	MagicVac, Individual Box	1
0690-12GEN	MagicVac, 12-Pack Individually Packaged	1

90° SWEEPS • SPA COMPONENTS & WHITE GOODS

90° Sweeps

Magic Plastics' Sweep 90° Fittings and assemblies are designed to maximize flow and minimize restriction. Available in a variety of configurations in 2" IPS sizes, Magic's Sweep 90°s will provide you with the best performance in the industry while meeting all of your plumbing requirements. All 90° Sweeps are manufactured from quality PVC.

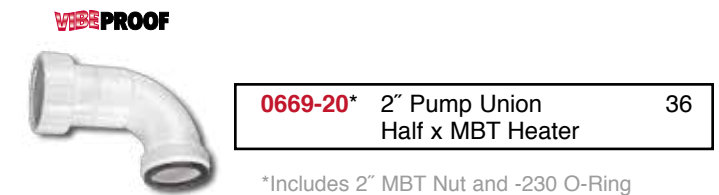
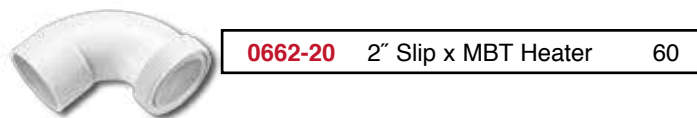
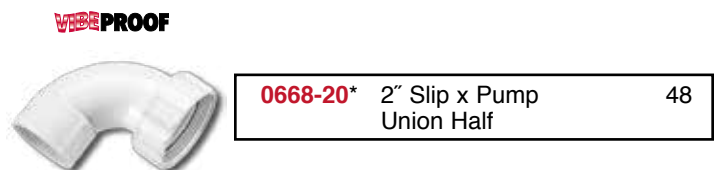
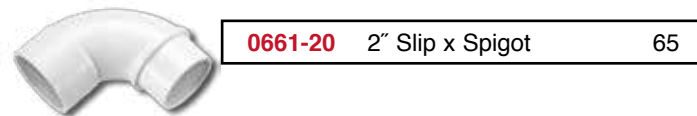
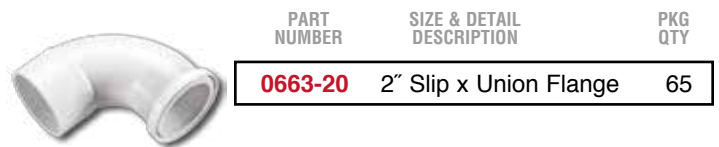
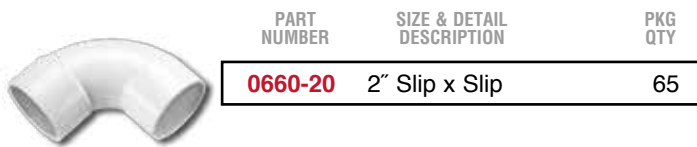

Spa Components & White Goods

Magic Plastics continues to expand our line of Spa Components. Contact the factory if you require an item or configuration that is not listed below or in our catalog of products. Magic Plastics is continually growing our line of products and will consider your product or component based on volume.

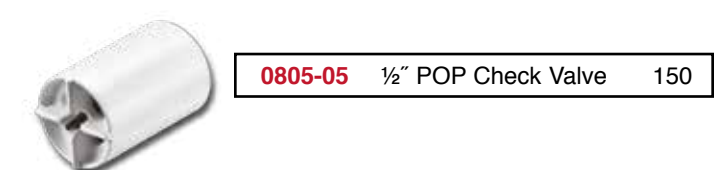
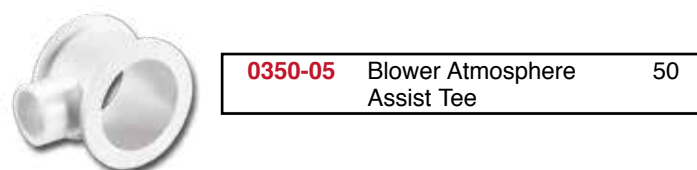
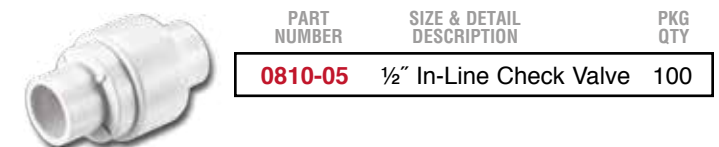

Manifolds

Easily fabricate custom stack lengths with our complete line of Water and Air Manifolds. Precision barb fittings assure a permanent seal. The compact designs of our Manifolds are ideal for space limitations. All Manifolds utilize standard Clear Vinyl Tubing. Custom configurations are available, contact the factory for details.



PART NUMBER	SIZE & DETAIL DESCRIPTION	PKG QTY
0320-05	1/2" 7-Port Air Manifold	50

Includes 2 Plugs



PART NUMBER	SIZE & DETAIL DESCRIPTION	PKG QTY
0341-10	1" Slip x Slip 6-Port Air Manifold	60

Accepts 3/8" vinyl tubing.



PART NUMBER	SIZE & DETAIL DESCRIPTION	PKG QTY
0342-10	1" Slip x Slip 8-Port Air Manifold	60

Accepts 3/8" vinyl tubing.



PART NUMBER	SIZE & DETAIL DESCRIPTION	PKG QTY
0343-10	1" Slip x Slip 10-Port Air Manifold	60

Accepts 3/8" vinyl tubing.



PART NUMBER	SIZE & DETAIL DESCRIPTION	PKG QTY
0330-05	1/2" MPT 3-Port Air Intake Manifold	75

Accepts 3/4" vinyl tubing – threads are 1/2" MPT.



PART NUMBER	SIZE & DETAIL DESCRIPTION	PKG QTY
0388-15	1 1/2" Slip x Slip 6-Port Water Manifold	50
0386-15	1 1/2" Slip x Spigot 6-Port Water Manifold	50

Includes 2 plugs – ports are 1/2" slip.



PART NUMBER	SIZE & DETAIL DESCRIPTION	PKG QTY
0361-20	2" Slip x Slip 2-Port Barbed Water Manifold	100
0362-20	2" Slip x Spigot 2-Port Barbed Water Manifold	100

Accepts 3/4" vinyl tubing.



PART NUMBER	SIZE & DETAIL DESCRIPTION	PKG QTY
0363-20	2" Slip x Dead End 2-Port Barbed Water Manifold	150

Accepts 3/4" vinyl tubing.



PART NUMBER	SIZE & DETAIL DESCRIPTION	PKG QTY
0369-20	2" Slip x Slip 4-Port Barbed Water Manifold	70
0364-20	2" Slip x Spigot 4-Port Barbed Water Manifold	66

Accepts 3/4" vinyl tubing.



PART NUMBER	SIZE & DETAIL DESCRIPTION	PKG QTY
0365-20	2" Slip x Dead End 4-Port Barbed Water Manifold	90

Accepts 3/4" vinyl tubing.



PART NUMBER	SIZE & DETAIL DESCRIPTION	PKG QTY
0368-20	2" Slip x Slip 6-Port Barbed Water Manifold	50
0366-20	2" Slip x Spigot 6-Port Barbed Water Manifold	50

Accepts 3/4" vinyl tubing.



PART NUMBER	SIZE & DETAIL DESCRIPTION	PKG QTY
0367-20	2" Slip x Dead End 6-Port Barbed Water Manifold	60

Accepts 3/4" vinyl tubing.



PART NUMBER	SIZE & DETAIL DESCRIPTION	PKG QTY
0321-10	3-in-1 1" 12-Port Air Manifold	50

Accepts 3/8" vinyl tubing. Includes 2 end caps and 4 plugs. Stackable.



PART NUMBER	SIZE & DETAIL DESCRIPTION	PKG QTY
0360-00	2" Water Manifold Plug	100

MagicMend® Pipe Extenders

Save valuable fittings and time with the MagicMend® Pipe Extenders. The MagicMend® is extremely effective and easy to use. Simply cut the defective fitting from the system, remove it and install the Extender. The MagicMend® will work at any glued plumbing joint, providing a permanent, invisible repair with insignificant flow restriction. The MagicMend® is available in 1/2" through 4" IPS sizes for Schedule 40 Pipe and 1", 1 1/4", 1 1/2" and 2" sizes for Class 200 Pipe.



PART NUMBER	IPS SIZE	QTY CASE	WT CASE
MagicMend® Pipe Extenders - Schedule 40			
0301-05	1/2"	48	2
0301-07	3/4"	48	2
0301-10	1"	48	3
0301-12	1 1/4"	48	5
0301-15	1 1/2"	48	5
0301-20	2"	48	8
0301-25	2 1/2"	48	18
0301-30	3"	48	22
0301-40	4"	48	36

Slips inside Schedule 40 pipe.



PART NUMBER	IPS SIZE	QTY CASE	WT CASE
MagicMend® Pipe Extenders - Class 200			
0304-10	1"	48	3
0304-12	1 1/4"	48	5
0304-15	1 1/2"	48	5
0304-20	2"	48	8

Slips inside Class 200 pipe.

MagicMend® Extender Fittings

The MagicMend® Extender Fitting is designed to glue over fittings where there is not a sufficient amount of pipe left for a connection. Simply remove any excess pipe and connect the MagicMend® by gluing over the existing fitting. The opposite end of both the 1 1/2" and 2" Extender Fitting will accept either 1 1/2" pipe or a 2" fitting so you have the option of continuing the plumbing with either pipe size. The MagicMend® Extender Fittings are available in 1 1/2" and 2" IPS sizes.



PART NUMBER	IPS SIZE	QTY CASE	WT CASE
MagicMend® Extender Fittings			
0303-15	1 1/2"	48	11
0303-20	2"	48	15

Fits over 1 1/2" or 2" fittings.

MagicMend® Insider Connectors

Why use an additional fitting when you can use a MagicMend® Insider Connector? The MagicMend® Insider Connector will join two pieces of PVC Schedule 40 pipe together. Should a pipe be cut off flush with concrete or buried underground, a MagicMend® will easily solve the problem. The MagicMend® Insider Connectors are available in 1", 1¼", 1½", 2", 3" and 4" IPS sizes.



PART NUMBER	IPS SIZE	QTY CASE	WT CASE
MagicMend® Insider Connectors			
0302-10	1"	48	3
0302-12	1¼"	48	5
0302-15	1½"	48	6
0302-20	2"	48	9
0302-30	3"	48	20
0302-40	4"	48	34

Connects Schedule 40 pipe.

Copper-To-PVC Adapters

This is the ideal fitting for an easy and smooth transition from Copper to PVC pipe. Fittings are assembled with Buna-70 O-Rings that provide a positive water tight seal and also an internal Stainless Steel gripper ring to prevent the pipe from pulling out, ensuring a solid connection. Available in 1½" and 2" IPS sizes.



PART NUMBER	SIZE & DETAIL DESCRIPTION	PKG QTY	WT
0606-15	1½" Slip - 2" Spigot Copper-to-PVC Adapter	24	13
0606-20	2" Slip Copper-to-PVC Adapter	18	11

Heater-Pump Adapters

Magic's Adapter Bushings are designed to increase a 1½" MBT fitting to a 2" MBT fitting simply by threading the adapter to the female threaded fitting. The internal thread of the bushing is 1½" FBT with an O-ring (included), ensuring a positive seal. The external thread is 2" FBT. You can choose from two configurations, one with O-ring groove for Heater applications and one without O-ring groove for Pump Union applications. Adapters are manufactured from quality PVC.



PART NUMBER	SIZE & DETAIL DESCRIPTION	PKG QTY	WT
0060150019	Adapter, 1½" FBT x 2" MBT w/O-Ring Groove	228	48
0060151019	Adapter, 1½" FBT x 2" MBT	228	49

Union Assemblies

Easy connection, self-aligning Buttress Threads and deep socket connections with glue traps make Magic Plastics' Union Assemblies reliable and leak-free. Additionally, Magic Plastics' Union Assemblies feature our Patented VibeProof® locking feature to assure the Union Nut will not loosen or backout should vibration occur. Magic Plastics' Union Assemblies are available in a variety of configurations in 1", 1½", 2", 2½" & 3" IPS sizes. For more information on VibeProof®, go to www.magicplastics.com/vibeproof/

VIBEPROOF



PART NUMBER	SIZE & DETAIL DESCRIPTION	PKG QTY
0602-15	1½" Pump Union Half	115
0602-20	2" Pump Union Half	72
0602-25	2½" Pump Union Half	50
0602-30	3" Pump Union Half	25

VIBEPROOF



0604-20	2" 45° Spigot Union Half	50
0605-20	2" 45° Slip Union Half	50



0611-15	1½" Slip Heater Union Half w/Split Nut	50
0611-18	1½" Slip-2" Spigot Heater Union Half w/Split Nut	50
0611-20	2" Slip Heater Union Half w/Split Nut	50

VIBEPROOF



0640-10	1" Slip x Slip Self-Aligning Union Assembly	100
0650-15	1½" Slip x Slip Self-Aligning Union Assembly	50
0650-18	1½" Slip - 2" Spigot Slip Self-Aligning Union Assembly	25
0650-20	2" Slip x Slip Self-Aligning Union Assembly	25
0650-25	2½" Slip x Slip Self-Aligning Union Assembly	25
0650-30	3" Slip x Slip Self-Aligning Union Assembly	25

High Heat Union Assemblies

Magic Plastics' Self-Sealing High-Heat Unions prevent plumbing failures due to extreme heat buildup caused by the Pump running dry. Made from durable GFN3, the High-Heat Unions include a positive O-Ring seal, eliminating the need for additional thread sealants. The Unions also incorporate Magic Plastics' Pat. Pending Vibeproof® Technology. Available in 1½" and 2" IPS sizes and rated at 175 PSI @ 75°F.

VIBEPROOF



PART NUMBER	SIZE & DETAIL DESCRIPTION	PKG QTY
0615-15	1½" MIP x 1½" Slip - 2" Spigot High-Heat Union Assembly	27

VIBEPROOF



0615-20	2" MIP x 2" Slip High-Heat Union Assembly	36
----------------	---	----

UNION ASSEMBLIES • UNION COMPONENTS

High Heat Union Assemblies

WIREPROOF



PART NUMBER	SIZE & DETAIL DESCRIPTION	PKG QTY
0615-20S	2" MIP x 2" Slip Sweep High-Heat Union Assembly	25

Union Components

All Magic Plastics Union Components are manufactured from quality PVC or ABS. Magic Union Components come bulk packaged and are available in 1½", 2" and 2½" IPS sizes.



PART NUMBER	SIZE & DETAIL DESCRIPTION	PKG QTY
0120103015	1½" FBT Union Nut	135
0120103020	2" FBT Union Nut	90
0120103025	2½" FBT Union Nut	50



0121109015	1½" FBT Repair Split Nut Set w/Screws	125
0121109020	2" FBT Repair Split Nut Set w/Screws	100
0121109025	2½" FBT Repair Split Nut Set w/Screws	74



0050103015	1½" Slip Tailpiece with O-Ring Groove	184
0050103020	2" Slip Tailpiece with O-Ring Groove	112
0050103025	2½" Slip Tailpiece with O-Ring Groove	100



0050104020	2" 45° Spigot Tailpiece with O-Ring Groove	100
0050104520	2" 45° Slip Tailpiece with O-Ring Groove	100



0050105015	1½" MBT x 1½" Slip Tailpiece	100
0050105018	2" MBT x 1½" Slip-2" Spigot Tailpiece	100
0050105020	2" MBT x 2" Slip Tailpiece	100

All Union Components Utilize O-Rings: 1½" - 225 2" - 230 2½" - 234

MBT = Male Buttress Threads

FBT = Female Buttress Threads

SNAP NUTS • UNION COMPONENTS

Snap Nuts

Magic Plastics' Snap Nut is uniquely designed to be used on SS heater housings as an alternative to a Split Nut. The Snap Nut eliminates the need for additional hardware, allowing for installation in a fraction of the time. No tools are required! The Snap Nut is manufactured from quality ABS and is available in 1½" and 2" sizes.



PART NUMBER	SIZE & DETAIL DESCRIPTION	PKG QTY
C015C	1½" Snap Nut Clip	350
C015N	1½" Snap Nut	100
C020C	2" Snap Nut Clip	350
C020N	2" Snap Nut	100

Clip and Nut must be purchased as a set.

Heater Union Components

All Magic Plastics Heater Union Components are manufactured from quality PVC or ABS. Magic Heater Union Components are bulk packaged and are available in 1½" MBT and 2" MBT with ½" through 2" Slip ends and glue wells. Our Washer Rings are recommended for all Magic Heater Union Components and are sold separately.



PART NUMBER	SIZE & DETAIL DESCRIPTION	PKG QTY
0050106007	1½" MBT x ¾" Slip-1" Spigot Tailpiece with O-Ring Groove	100
0050106010	1½" MBT x 1" Slip Tailpiece with O-Ring Groove	100



0050106007-OF	1½" MBT x ¾" Slip-1" Spigot Tailpiece with O-Ring Groove (Offset)	100
0050106010-OF	1½" MBT x 1" Slip Tailpiece with O-Ring Groove (Offset)	100



0050106012	1½" MBT x 1¼" Slip Tailpiece with O-Ring Groove	100
0050106015	1½" MBT x 1½" Slip Tailpiece with O-Ring Groove	100
0050106015-SH	1½" MBT x 1½" Slip Tailpiece with O-Ring Groove (Short)	100



0050107018	2" MBT x 1½" Slip-2" Spigot Tailpiece with O-Ring Groove	100
0050107020	2" MBT x 2" Slip Tailpiece with O-Ring Groove	100
0050107020-SH	2" MBT x 2" Slip Tailpiece with O-Ring Groove (Short)	270



0121108015	1½" FBT Heater Split Nut Set w/Screws	125
0121108020	2" FBT Heater Split Nut Set w/Screws	100
0121108025	2½" FBT Heater Split Nut Set w/Screws	74

All Heater Union Components Utilize Washer Rings.
 1½" MBT - 224 WR
 2" MBT - 229 WR

MBT = Male Buttress Threads
 FBT = Female Buttress Threads

THREE PIECE VALVES • TANK ADAPTER VALVES

Three Piece Valves

The Three-Piece Valve design can be easily disassembled, allowing you to clean and service the valve. The easy push-pull slide and 100% positive seal is ideal for a number of applications. Magic Three-Piece valves are available in a variety of configurations in both 1½" and 2" IPS sizes.



Slip x Slip

PART NUMBER	IPS SIZE	QTY CASE/ MASTER	WT CASE/ MASTER
0101-15	1½"	12/48	10/42
0101-20	2"	12/48	13/50



Slip x Spigot

PART NUMBER	IPS SIZE	QTY CASE/ MASTER	WT CASE/ MASTER
0112-15	1½"	12/48	10/40
0112-20	2"	12/48	12/48



Spigot x Spigot

0102-15	1½"	12/48	10/38
0102-20	2"	12/48	12/47

Tank Adapter Valves

Magic Plastics' Tank Adapter valves were designed specifically for bulkhead applications. Both standard and Low Profile designs are available in the popular Uni-Body style as well as the serviceable Three-Piece design. 1½" size, white or black.



Slip x Tank Adapter Uni-Body

PART NUMBER	IPS SIZE	QTY CASE/ MASTER	WT CASE/ MASTER
0416-15	1½"	10/40	9/40
B416-15	1½"	10/40	9/40

B416-15=BLACK



Slip x Tank Adapter

PART NUMBER	IPS SIZE	QTY CASE/ MASTER	WT CASE/ MASTER
0116-15	1½"	10/40	11/43
0116-15LP	1½"	10/40	10/41
B116-15	1½"	10/40	11/43
B116-15LP	1½"	10/40	10/41

B116-15 = Black
0116-15LP = Low Profile

Specialty Products



PART NUMBER	SIZE & DETAIL DESCRIPTION	PKG QTY
0203-004	2" Plug and Seal Ring - EPDM Seal	1



0621-30	3" Male Closet Flange	90
----------------	-----------------------	----



0622-30	3" Female Closet Flange	70
----------------	-------------------------	----



0610-20	2" 45° Drain Outlet Adapter	1
----------------	-----------------------------	---

HOSE BIBBS • PVC UNIONS

Hose Bibbs

Magic Plastics' Hose Bibbs are manufactured from quality PVC and are completely serviceable. Designed for use for temperatures up to 120° F at 50 PSI. Pipe and Hose Threads comply with ASTM standards. Available in 1/2" and 3/4".



PART NUMBER	IPS SIZE	QTY CASE/ MASTER	WT CASE/ MASTER
PVC Hose Bibbs			
0203-05	1/2"	48/192	8/35
0203-07	3/4"	48/192	8/36

PVC Industrial Unions

All industrial unions are equipped with ACME threads and EPDM O-Rings. Available in 1/2" through 4" IPS sizes. 6" and 8" available, please contact the factory direct for pricing and lead-times.



PART NUMBER	SIZE & DETAIL DESCRIPTION	PKG QTY
10650-05	1/2" Union Assembly	48
10650-07	3/4" Union Assembly	48
10650-10	1" Union Assembly	48
10650-15	1 1/2" Union Assembly	48
10650-20	2" Union Assembly	24
10650-25	2 1/2" Union Assembly	12
10650-30	3" Union Assembly	12
10650-40	4" Union Assembly	8

Expandable Repair Couplings

The Slip x Spigot design of the couplings allows for a quick, simple and permanent solution to repair broken pipes. You can also use the Expandable Coupling for a union in piping installations. The double O-Ring seal design provides added leak protection against pipe deflection and also insures smooth movement during installation. Expandable Repair Couplings are made from quality PVC and are available in ½" through 4" IPS sizes. 6" and 8" available, please contact the factory direct for pricing and lead-times.



PART NUMBER	SIZE & DETAIL DESCRIPTION	PKG QTY
0620-05	½" Expansion Coupling	48
0620-07	¾" Expansion Coupling	48
0620-10	1" Expansion Coupling	48
0620-15	1½" Expansion Coupling	24
0620-20	2" Expansion Coupling	24
0620-30	3" Expansion Coupling	12
0620-40	4" Expansion Coupling	6

Compression Couplings

Our general use Compression Couplings are ideal for both repairs and installations. Santoprene gaskets provide a 100% maintenance-free seal. This is the perfect fitting for emergency situations, no solvent required. Compression Couplings are made from quality PVC and are available in ½" through 4" IPS sizes. 6" and 8" available, please contact the factory direct for pricing and lead-times.



PART NUMBER	SIZE & DETAIL DESCRIPTION	PKG QTY
0630-05	½" Compression Coupling	48
0630-07	¾" Compression Coupling	48
0630-10	1" Compression Coupling	48
0630-15	1½" Compression Coupling	24
0630-20	2" Compression Coupling	24
0630-30	3" Compression Coupling	12
0630-40	4" Compression Coupling	6

O-RINGS • WASHER RINGS • MAGIC WRENCH

O-Rings

All O-Rings are manufactured from Buna-70. Magic Plastics O-Rings fit the products listed in our catalog. Other suppliers may have variant O-Ring dimensions and specifications. Other materials are available upon request. Please contact the factory for details.



PART NUMBER	SIZE & DETAIL DESCRIPTION	PKG QTY
0301-225-12	Kit, O-Ring 1½" Union	12
0301-229-12	Kit, O-Ring 2" I.B.C. Valve	12
0301-230-12	Kit, O-Ring 2" Union	12
0301-234-12	Kit, O-Ring 2½" Union	12
0301-223-12	Kit, O-Ring 1½" Copper to PVC Adapter	12
0301-227-12	Kit, O-Ring 2" Copper to PVC Adapter	12

Washer Rings

Magic Plastics Washer Rings are specifically designed to fit the Unions and Heater Union components and assemblies listed in our catalog.



PART NUMBER	SIZE & DETAIL DESCRIPTION	PKG QTY
0301-224W-12	Kit, Washer Ring 1½" Union	12
0301-229W-12	Kit, Washer Ring 2" Union	12
0302-020B-12	Kit, Washer Ring 2" Slip x MBT Valve	12

Magic Wrench

The new Magic Wrench removes 9 different pump lids and numerous equipment lids. Don't risk damaging your pump lid by using hammers and 2 x 4's, safely remove your pump lids with the Magic Wrench. Manufactured from super-tough Glass Filled Nylon, the Magic Wrench is the perfect tool to carry with you on service calls.

To see the Magic Wrench in action, visit our download center at www.magicplastics.com.



PART NUMBER	SIZE & DETAIL DESCRIPTION	PKG QTY
PPTW	Magic Wrench	12

REPLACEMENT COMPONENTS

Replacement Components



PART NUMBER	SIZE & DETAIL DESCRIPTION	PKG QTY
0030101015	Slip Flange 1 1/2"	1
0030101020	Slip Flange 2"	1
0040101015	Spigot Flange 1 1/2"	1
0040101020	Spigot Flange 2"	1



0603-15	1 1/2" Valve Body with Handle	1
0603-20	2" Valve Body with Handle	1

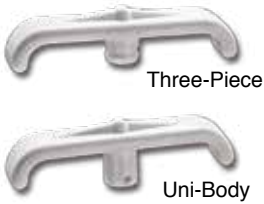

0090101000	Handle 1 1/2" & 2" (For Three-Piece Valve)	1
0090102000	Handle 1 1/2" & 2" Uni-Body	1
0090102025	Handle 2 1/2" Uni-Body	1



0080301015-12	Kit, Seals 1 1/2" Valve	12
0080301020-12	Kit, Seals 2" Valve	12



0402-001-12	Kit, Nut with Nylon Insert 10-24	12
0403-001-12	Kit, Screw Hex with Washer 10-24 x 13/8"	12



0120102015	Nut 1 1/2" MSPT with Flange White	1
0120502000	Nut 1 1/2" MSPT with Flange Black	1
0302-002-12	Kit, Flat Washer 1 1/2" Bulkhead Fitting	12

I.B.C. Products

A number of products are available for this growing industry. The durable Uni-Body valve attaches to the I.B.C. liner by way of a union-like Buttress threaded Flange. A probe cutter allows the valve to be attached securely to the liner in any position, providing a positive seal connection before the liner membrane is pierced for evacuation. The I.B.C. Valve and Flanges are available in a variety of configurations. In addition, the Flanges are available in both PVC and LLDPE materials.



IBC Valve

PART NUMBER	IPS SIZE	QTY CASE/ MASTER	WT CASE/ MASTER
0504-20	2"	10/40	11/44

Standard



Buttress Plug

PART NUMBER	IPS SIZE	QTY CASE/ MASTER	WT CASE/ MASTER
0703-20	2"	125/500	16/65



FIPT x FIPT Valve

0404-20	2"	12/48	9/37
----------------	----	-------	------



Nut & Flange Assembly

0706-20	2"	108	34
0708-20	2"	108	39
0709-20	2"	108	39

(For Standard IBC Valve)
 0706-20=LLDPE
 0708-20=PVC
 0709-20=SANTOPRENE



MBT x MIPT/FIPT Valve

0520-20	2"	10/40	11/44
----------------	----	-------	-------



FIPT Threaded Flange

0705-20	2"	144	23
0707-20	2"	144	29

0705-20=LLDPE
 0707-20=PVC



Probe Cutter

0701-20	2"	12/48	7/27
----------------	----	-------	------



FBT Threaded Flange

0710-00	SPECIAL	108	23
0711-00	SPECIAL	108	30

0710-00=LLDPE
 0711-00=PVC

WARRANTY

WARRANTY FOR STANDARD PRODUCTS- Seller warrants all Seller products to be free from defects in materials and workmanship in normal use for a period of one (1) year from the date of invoice. If Customer receives defective goods or parts, Customer may send such defective goods or parts prepaid to Seller in Valencia, California accompanied by a letter stating the nature of the defect. After examination, if there is determined to be a defect in materials or workmanship, Seller shall, at its sole option and discretion, rework, repair or replace the defective goods or parts, or reimburse Customer for the cost of the goods or parts. All shipping costs for return of defective goods and replacements are the responsibility of Customer. Customer agrees that Seller will not be held responsible for parts or labor (other than Seller's parts and labor) in connection with reworking, repairing or replacing of such goods or parts. THE WARRANTY STATED ABOVE IS IN LIEU OF ALL OTHER WARRANTIES, CONDITIONS OR OTHER TERMS, EXPRESS OR IMPLIED, STATUTORY OR OTHERWISE, INCLUDING WITHOUT LIMITATION ANY IMPLIED WARRANTIES OF TERMS AS TO QUALITY, MERCHANTABILITY, FITNESS FOR PARTICULAR PURPOSE OR OTHERWISE, WHETHER IMPLIED BY CUSTOM OR LAW.

LIMITATION OF DAMAGES - IN NO EVENT SHALL SELLER BE LIABLE FOR ANY INDIRECT, INCIDENTAL, CONSEQUENTIAL, SPECIAL OR PUNITIVE DAMAGES OF ANY KIND OR NATURE ARISING OUT OF OR RELATING TO THE TRANSACTION CONTEMPLATED HEREBY OR TO THE MANUFACTURE, SALE, DELIVERY, RESALE, REWORK, REPAIR, REPLACEMENT, OR USE OF ANY PRODUCTS, WHETHER SUCH LIABILITY IS BASED IN CONTRACT, TORT, NEGLIGENCE, STRICT LIABILITY OR OTHERWISE, EVEN IF SELLER HAD BEEN WARNED OF THE POSSIBILITY OF ANY SUCH DAMAGES.

THE WARRANTIES AND DISCLAIMERS OF WARRANTIES SET FORTH HEREIN MAY NOT BE EXTENDED, ALTERED OR OTHERWISE MODIFIED EXCEPT BY WRITTEN INSTRUMENT SIGNED BY SELLER.

TERMS: NET 30 DAYS (O.A.C.)
MINIMUM ORDER \$50.00 NET (CASE QUANTITY)
LEAD TIME: 1-3 BUSINESS DAYS





MAGIC PLASTICS, INC.

25215 Ave. Stanford • Valencia, CA 91355

(661) 257-4485 • Toll Free (800) 369-0303

FAX (661) 257-1911

www.magicplastics.com

Email sales@magicplastics.com