

# PRODUCT CATALOG



[WWW.LIBERTYGARDENPRODUCTS.COM](http://WWW.LIBERTYGARDENPRODUCTS.COM)





Since 1989, **Liberty Garden Products** has pioneered new and smarter ways to store garden hoses. Liberty Garden metal hose reel storage products have set the bar in quality and craftsmanship in our industry. That's why you can count on our dependable products to assist in turning your lawn and garden project into the pride of any neighborhood.

Some of the benefits of choosing **Liberty Garden Products**:

**Style:** With styles ranging from classic to contemporary, Liberty Garden Products are designed to work for many intended tasks. We use the finest materials to create beautiful and practical designs that will surely add class to any home or garden.

**Craftsmanship:** This is what sets Liberty Garden apart and the heart of everything we do. Many hours of thought goes into each unique metal product we produce.

**Lasting Quality:** Liberty Garden makes sure all our hose storage products are tough and can handle the rigors of most outdoor elements. Using powder coated steel, cast aluminum, brass and galvanized fittings our products have stood the test of time over our rival plastic competitors.

Due to these valued attributes, people from all walks of life have come to rely on Liberty Garden to provide years of satisfaction.

A white, handwritten signature in cursive script that reads "Kent Southard". The signature is fluid and stylized, with the first letters of each word being prominent.

Kent Southard / Owner / CEO  
Liberty Garden Products

# PRODUCT LIST



Liberty Garden offer's a complete line of the finest steel, resin, poly resin aluminum, hose reels, carts, stands, butlers and hose pots on the market today.



ROTATING HOSE REELS



HOSE BUTLERS



HOSE CARTS



HOSE POTS



HOSE STANDS



WALL MOUNT  
POLY RESIN



WALL  
MOUNTED  
HOSE  
REELS



HOSE  
ACCESSORIES

THE LEADER IN WATER HOSE STORAGE SOLUTIONS



# ROTATING HOSE REELS



Hose and mounting hardware not included

## MODEL #714



125' TO 150' HOSE LENGTHS



ROTATES  
**360°**

Holds 125'  
of 5/8" hose

**#714**

DECORATIVE CAST ALUMINUM

**NAVIGATOR™**

ROTATING HOSE REEL

- Steel & Cast Aluminum Construction
- Basket with Lift Up Storage Tray
- Durable Bronze Powder Coat Finish
- 5' Leader Hose included
- 90° Solid Brass Swivel
- Full 360° Rotation

**#710**

**NAVIGATOR™**

ROTATING HOSE REEL

Covered by US patent numbers 9,422,132 and 10,150,645

Includes all four models

Seen On   
**I WANT THAT**



Holds 150' of 5/8" hose

DURABLE POWDER COAT FINISHES



# ROTATING HOSE REELS

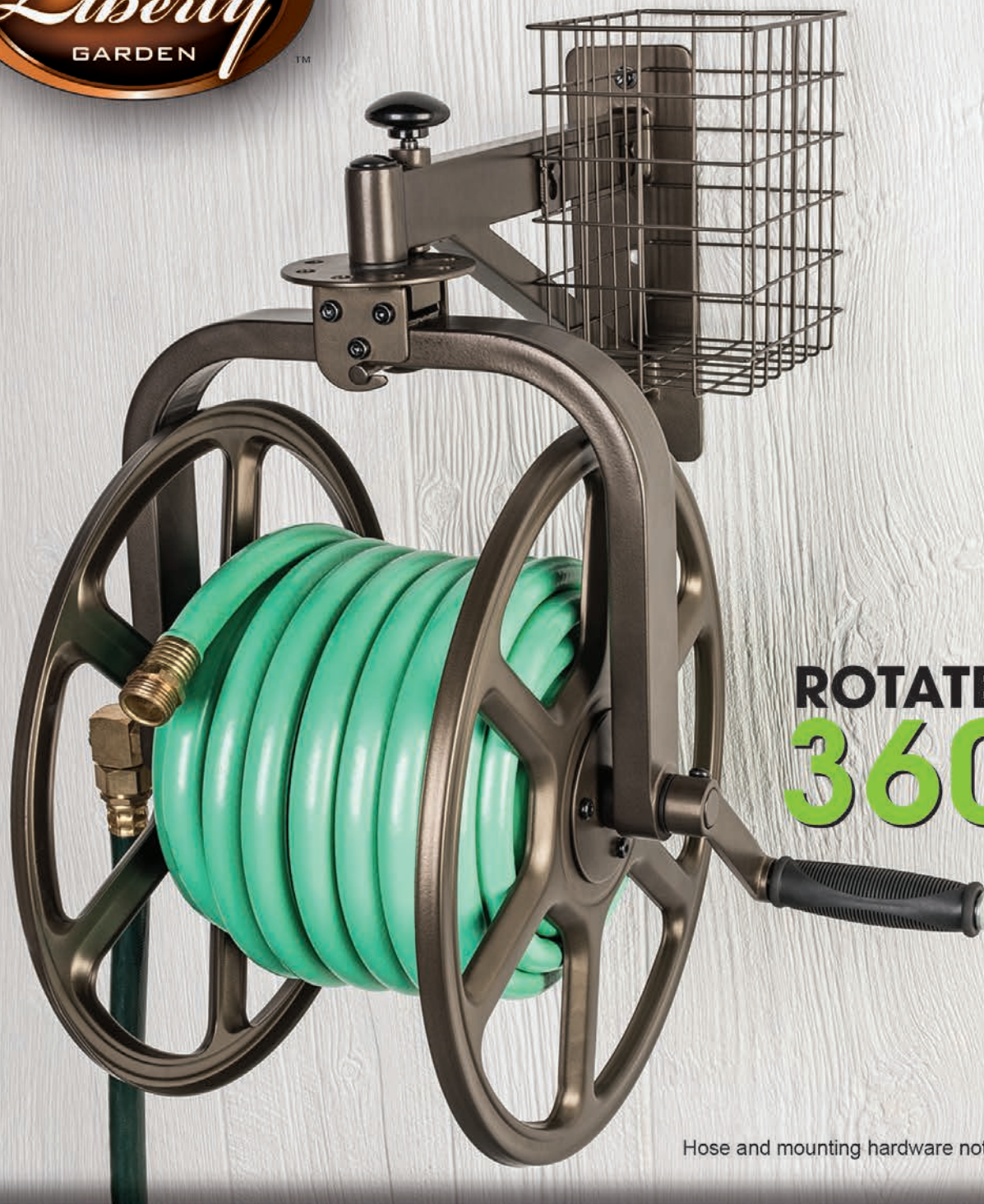

ROTATES  
**360°**

Hose and mounting hardware not included

MODEL #712



125' TO 200 HOSE LENGTHS



Holds 125' of 5/8" hose

#712

SINGLE ARM

**NAVIGATOR™**

ROTATING HOSE REEL

The Revolution and Single Arm models feature multiple locking positions to help wind and direct the hose to your desired location. The Revolution features twenty four locking positions and a 12" x 14" storage tray. These popular powder coated, steel hose reels can hold 125' to 200' of 5/8" garden hose.

**Both Feature:**

- Full 360° Rotation
- 90° Solid Brass Swivels
- Durable Steel Construction
- Durable Powder Coat Finishes
- Attachable Crank Handles
- 5' Leader Hoses included

#713

**REVOLUTION™**  
ROTATING HOSE REEL



Holds 200' of 5/8" hose

**DURABLE POWDER COAT FINISHES**



# WALL MOUNTED HOSE REELS



Hose and mounting hardware not included

## MODEL #707



## #704 ALUMINUM DECORATIVE WALL MOUNTED HOSE REEL



Holds 125' of 5/8" hose

## #707 ALUMINUM DECORATIVE WALL MOUNTED REEL WITH HOSE GUIDE

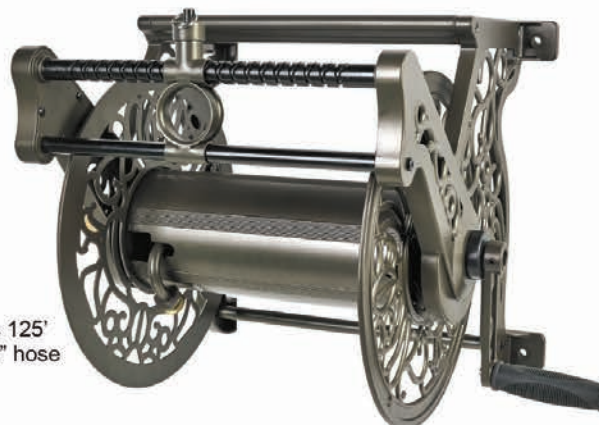

Holds 125' of 5/8" hose

## #708 STEEL DECORATIVE WALL MOUNTED HOSE REEL

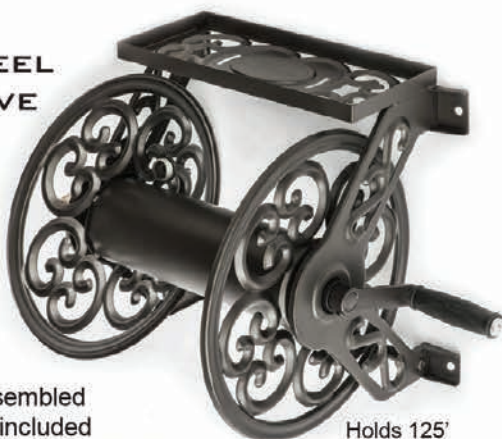

### Features:

- Bronze finish
- Comes fully assembled
- 5' Leader hose included
- Powder coated steel construction
- Ready to use-easy to install
- Perfect for home gardening needs

Holds 125' of 5/8" hose

## STEEL MULTI-PURPOSE WALL & FLOOR MOUNTED HOSE REELS

### #703

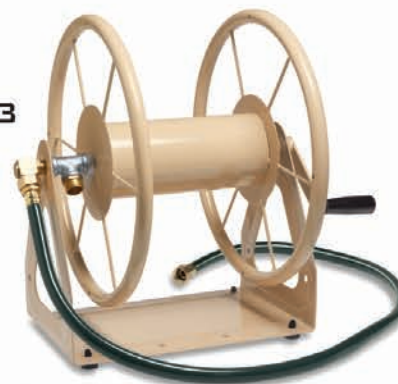

Holds 200' of 5/8" hose

### #709



### #709-S



Holds 125' of 5/8" hose

The versatile 703 and 709 hose reels are heavy-duty, solid wall mounted reels that anchor to lawn or turf or add the rubber boots for a nonskid floor mount. Made of tough 13 gauge steel with industrial strength powder coated finishes, these units will suit a variety of your hose storage needs.

The 709 is also available in stainless steel.





# WALL MOUNTED HOSE BUTLERS



Hose and mounting hardware not included

## MODEL #671



# 75' TO 175' HOSE LENGTHS



Holds 125'  
of 5/8" hose

**#670 WALL MOUNTED  
DECORATIVE HOSE  
BUTLER**



Holds 125'  
of 5/8" hose

**# 234 LIBERTY STAR  
WALL MOUNTED HOSE  
BUTLER**



Holds 125'  
of 5/8" hose

**#671 WALL MOUNTED  
DECORATIVE HOSE  
BUTLER**



Holds 125'  
of 5/8" hose

**#245 WALL MOUNT  
HOSE BUTLER**



Holds 125'  
of 5/8" hose

**#241 WALL  
MOUNTED DECORATIVE  
HOSE BUTLER  
WITH SHELVE**



Holds 125'  
of 5/8" hose

**#231 WALL  
MOUNT DECORATIVE  
HOSE BUTLER**



Holds 125'  
of 5/8" hose

**#230 / #231  
STAINLESS  
STEEL  
HOSE  
BUTLERS**



Holds 175'  
of 5/8" hose



**#598  
WALL  
MOUNT  
HOSE  
BUTLER**

Holds 125'  
of 5/8" hose

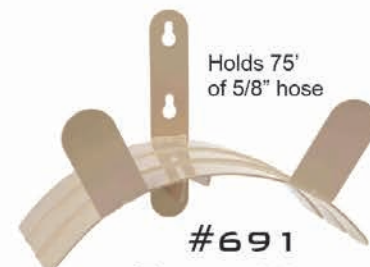

Holds 75'  
of 5/8" hose

**#691  
BASIC WALL  
MOUNTED HOSE  
BUTLER**

**DURABLE AND LASTING FINISHES**





# HOSE STANDS



Hose not included

## MODEL # 1 1 6



**#640 CARRINGTON  
HOSE STAND  
WITH BIB**

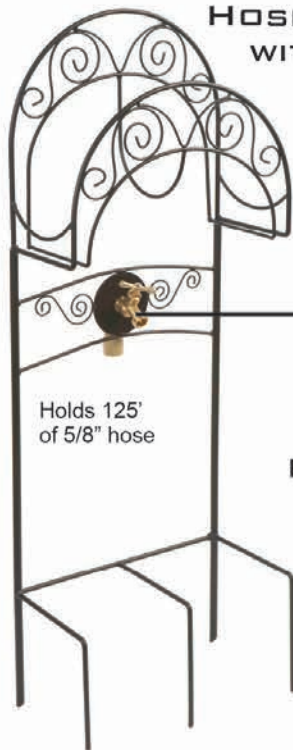

Holds 125'  
of 5/8" hose

**#642 DRAGONFLY  
HOSE STAND  
WITH BIB**



Holds 125'  
of 5/8" hose



**Brass Faucets Included**

## **OUR MOST POPULAR MODELS!**

**NO HOLES TO DIG.  
NO CEMENT TO POUR.**  
Just position stand-Step down  
on anchor points to install.

### **Features:**

- Brass water bibs
- Holds 125 feet of 5/8" hose
- Features 5 anchor points to secure in lawn

**Liberty Garden Products** hose stands are made of heavy gauge steel then powder coated for durable weather resistant use. Keep hoses neat and out of the way with these metal stands. Our most popular stands have three to five step down anchors and allow the flexibility of moving if needed.

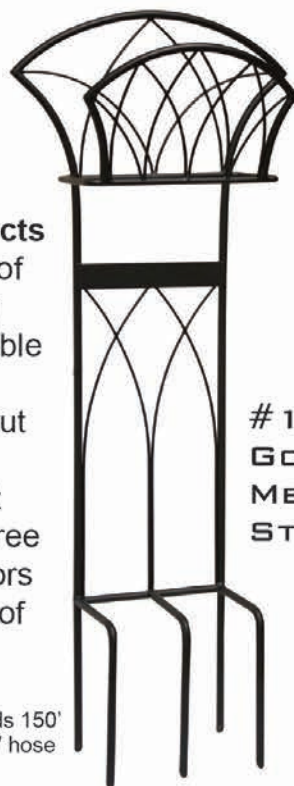

Holds 150'  
of 5/8" hose

**#116  
GOTHIC  
METAL  
STAND**



Holds 125'  
of 5/8" hose

**#647  
MANGER  
METAL  
STAND**



Holds 150'  
of 5/8" hose

**#119  
HOSE  
STAND  
WITH  
SHELVE**





# HOSE STANDS



Hose not included

MODEL #647



# 125' TO 150' HOSE LENGTHS



**Liberty Garden** also offers single prong, adjustable and permanent ground or concrete mounting options. These stands are made of durable powder coated steel and cast aluminum for durable weather resistant use.

### Features:

- Holds 125 feet of 5/8" standard garden hose
- Powder Coat finishes
- Two anchor points secure in lawn



#645  
DECORATIVE  
METAL HOSE  
STAND

Holds 125'  
of 5/8" hose



#646-R  
DECORATIVE  
METAL HOSE  
STAND

Holds 125'  
of 5/8" hose



#117  
STAR  
METAL  
HOSE  
STAND

Holds 125'  
of 5/8" hose



#648  
DECORATIVE  
METAL  
HOSE  
STAND

Holds 125'  
of 5/8" hose



#649  
HYDE PARK  
DECORATIVE  
METAL  
HOSE  
STAND

Holds 125'  
of 5/8" hose



#692  
METAL  
HOSE  
STAND

NOTE:  
These style stands  
mount in compact  
soil or concrete.

Holds 150'  
of 5/8" hose



#693  
METAL  
HOSE  
STAND  
WITH  
BIB

Holds 150'  
of 5/8" hose

**DURABLE POWDER COAT FINISHES**



# TWO WHEEL HOSE CARTS



Hose not included

## MODEL #301



**Liberty Garden** two wheel hose carts are designed to make hose storage easy and stylish. Each cart is specifically designed for your gardening purposes. These carts have a tough weather resistant powder coat finish and can hold a variety of 5/8" hose sizes from 150' - 300'.



**#301 TWO WHEEL DECORATIVE HOSE REEL CART**

**Features:**

- **NEVER FLAT TIRES**
- Removable Storage Basket
- Cushion Grip Handle
- Adjustable Handle Knobs
- Durable Powder Coat Finish
- 13 Gauge Steel Construction
- Holds Up to 200' of 5/8" Hose
- 5' Leader Hose Included
- 90° Solid Brass Swivel

Holds 200' of 5/8" hose

**#302 TWO WHEEL DECORATIVE HOSE REEL CART**



Holds 200' of 5/8" hose

**Features:**

- **NEVER FLAT TIRES**
- Removable Storage Basket
- Durable Powder Coat Finish
- 13 Gauge Steel Construction
- Holds Up to 200' of 5/8" Hose
- 5' Leader Hose Included
- 90° Solid Brass Swivel

**#880 TWO WHEEL HOSE REEL CART**



Holds 300' of 5/8" hose



# FOUR WHEEL HOSE CARTS



Hose not included

## MODEL #871-SB



# 250' TO 350' HOSE LENGTHS



**#870  
FOUR WHEEL  
HOSE REEL CART**



**#840  
FOUR WHEEL  
HOSE REEL CART**



**#840-SB  
FOUR WHEEL HOSE REEL  
CART WITH BASKET**

Solid  
**NEVER FLAT**  
Tires



**Liberty Garden** four wheel hose carts are designed to make hose storage easy and stylish. Pneumatic tires allow our carts to roll easily over rough ground. Solid **NEVER FLAT** tires are also offered. Made of steel, these carts all have a tough, weather resistant powder coat finish. Our vast variety of hose reel carts can hold up to 250'-350' of 5/8" garden hose and all come with a 5' leader hose.

**#872  
FOUR WHEEL  
HOSE REEL  
CART WITH  
BASKET**



#### **Four Wheel Cart Features:**

- Perfect for Garden & Landscaping
- Keeps Hose Neat - Ready to Use
- 13 Gauge Steel Construction
- Hold Up to 250' - 350' of 5/8" Hose
- 5' Inlet Hose Included
- All Brass/Galvanized Fixtures
- Durable Powder Coat Finish
- Low Center of Gravity Prevents Tipping

**DURABLE POWDER COAT FINISHES**



# HOSE POTS



Hose not included

MODEL # 1924



**#1920 HIGH  
DENSITY RESIN BASKET  
WEAVE HOSE POT**



Holds 100'  
of 5/8" hose

**#1924 HIGH  
DENSITY RESIN  
BANDED HOSE POT**



Holds 100' of 5/8" hose

**#1925 HIGH  
DENSITY RESIN ROPE  
COPPER HOSE POT**



Holds 100'  
of 5/8" hose

**Liberty Garden Products** offers decorative hose pots that will look great on your lawn or patio while concealing your unsightly garden hoses. Each pot is made from either solid steel or high density resin and then plated or hand finished with an attractive, durable coating. Six different designs and colors are featured for all tastes and decors.

**Features:**

Attractive Finishes • Inlet Port for Hose Connection to Water Supply • Drainage in Base

**#1901 RUSTIC  
HOSE POT**



Holds 100' of 5/8" hose

**#1908 VIPOR  
HOSE POT**



Holds 100' of 5/8" hose



POLY RESIN WALL MOUNTED PRODUCTS



Water Hose not included  
Mounting hardware included

MODEL #510



100' TO 225' HOSE LENGTHS



**#501 LIBERTY BASICS W/STORAGE  
COMPARTMENT HOSE HANGER**



Holds 125'  
of 5/8" hose

**#510 LIBERTY BASICS WALL  
MOUNT HOSE REEL**



Holds 100'  
of 5/8" hose

*Liberty*  
basics™

**HARDWARE INCLUDED ON ALL MODELS**

**Features:**

- Poly Resin will not rust
- Holds up to 100' - 225' of standard water hose
- Keyhole designs for easy removal and mounting
- 6' Leader Hose Included

**#512 LIBERTY BASICS WALL  
MOUNTED HOSE REEL WITH SHELF**



Holds 225'  
of 5/8" hose

**DURABLE POLY RESIN FINISHES**



# HOSE ACCESSORIES



## #615 PINECONE HOSE GUIDE

Control the pulling and maneuvering of garden hoses through delicate flower beds and landscaping with these decorative protective hose guides with easy to install anchor pins. This beautiful style blends easily into any surrounding lawn or garden area.



## #1100

### HOSE HANDLE

NO MORE DIRTY HANDS!



The Liberty Model 1100 Hose Handle allows the garden hose to easily glide through it while keeping your hands clean from dirt, mud, and build-up that can accumulate on a garden hose while on the ground or in storage.

#### Features:

- Heavy Duty Polymer Composite
- 5/8" Hose Capacity

ATTRACTIVE PATINA AND DURABLE FINISHES



TO LEARN MORE CALL TOLL FREE AT 1-866-820-5805



FOLLOW US ON



YouTube

libertygardenproducts





QUALITY  
SINCE 1989

Liberty Garden Products / 1161 S. Park Drive / Kernersville, NC 27284  
[www.libertygardenproducts.com](http://www.libertygardenproducts.com)