

LA CROSSE®  
TECHNOLOGY

# WI-FI PROFESSIONAL WEATHER STATION

WITH  **AccuWeather** FORECAST  
INSTRUCTION MANUAL



## Welcome!

Congratulations on your new Professional Weather Station and welcome to the La Crosse Technology family! This product was designed with you in mind by our hometown team of weather enthusiasts based in La Crosse, Wisconsin.

Model: C83100  
DC: 012619

# TABLE OF CONTENTS

3	<a href="#">Quick Setup</a>	18	<a href="#">Wind Speed Readings &amp; History</a>
4	<a href="#">Quick Mounting Tips</a>	19	<a href="#">Rainfall Readings &amp; History</a>
4	<a href="#">Button Functions</a>	21	<a href="#">Temperature/Humidity Readings &amp; HI/LO Records</a>
5	<a href="#">Weather Station Icons</a>	22	<a href="#">Feels Like Temperature</a>
6	<a href="#">Connect to La Crosse View™ App</a>	22	<a href="#">Temperature Trend Arrows</a>
8	<a href="#">Benefits of Connecting to La Crosse View™</a>	22	<a href="#">Relative Pressure Reading</a>
9	<a href="#">Enhanced Weather Forecasts w/La Crosse View™</a>	23	<a href="#">Sensor Reception Indicators</a>
9	<a href="#">Advanced Forecast &amp; Chance Precipitation</a>	23	<a href="#">Sensor ID and Search</a>
10	<a href="#">AccuWeather Daily Forecasts</a>	24	<a href="#">Delete Sensors</a>
10	<a href="#">AccuWeather Hourly Forecasts</a>	24	<a href="#">Low Battery Indicators</a>
11	<a href="#">AccuWeather HI/LO Temperatures</a>	24	<a href="#">Factory Restart Station</a>
11	<a href="#">AccuWeather Wind Direction</a>	25	<a href="#">Detailed Sensor Setup and Mounting</a>
11	<a href="#">Custom Data Streams</a>	28	<a href="#">Bonus Station Setup</a>
12	<a href="#">Additional Sensors can read to your app</a>	29	<a href="#">Help Us, Help You</a>
13	<a href="#">Status Messages when Connected</a>	29	<a href="#">Join the Conversation</a>
14	<a href="#">Features of Your Weather Station</a>	30	<a href="#">Specifications</a>
14	<a href="#">Adjustable Backlight</a>	31	<a href="#">Care and Maintenance</a>
14	<a href="#">Auto Dim Backlight</a>	31	<a href="#">Warranty and Support</a>
15	<a href="#">Settings Menu</a>	32	<a href="#">FCC Statement</a>
16	<a href="#">Extra Sensor Area</a>	32	<a href="#">Canada Statement</a>

## QUICK SETUP

1. Insert 2 - C batteries into your LTV-W1 Wind Sensor.
2. Insert 2 - AA batteries into your LTV-R2 Rain Sensor.
3. Insert 2 - AA batteries into your LTV-TH2 Thermo-Hygro Sensor.
4. Insert the power cord into your C83100 station. Remove the red insulation tab from the CR2032 battery compartment found on the bottom of your station.
5. Insert batteries into your Bonus Station.
6. Download the La Crosse View™ App (App Store or Google Play)
7. Follow along with our instructional videos to connect your station to the app:  
[http://bit.ly/LaCrosseView\\_Support\\_Vid\\_01\\_1](http://bit.ly/LaCrosseView_Support_Vid_01_1)  
[http://bit.ly/LaCrosseView\\_Support\\_Vid\\_01\\_2](http://bit.ly/LaCrosseView_Support_Vid_01_2)
8. Mount your sensors in appropriate locations.



### WARNING:

1. This product contains a Button Cell Battery.
2. If swallowed, it could cause severe injury or death in just 2 hours.
3. Seek medical attention immediately.

### AVERTISSEMENT:

1. Cet article contient une pile bouton.
2. De graves blessures ou la mort pourraient suivre dans les deux heures suivant l'ingestion.
3. Demander l'aide de professionnels de la santé sur le champ.

### WARNING - KEEP BATTERIES OUT OF REACH OF CHILDREN

1. Swallowing may lead to serious injury in as little as 2 hours or death, due to chemical burns and potential perforation of the oesophagus.
2. If you suspect your child has swallowed or inserted a button battery, immediately seek urgent medical assistance.
3. Examine devices and make sure the battery compartment is correctly secured, e.g. that the screw or other mechanical fastener is tightened.
4. Do not use if compartment is not secure.
5. Dispose of used button batteries immediately and safely. Flat batteries can still be dangerous.
6. Tell others about the risk associated with button batteries and how to keep their children safe.

# QUICK MOUNTING TIPS

## WIND SPEED

Ensure the sensor is mounted vertically – an unobstructed rooftop is ideal.

- Your wind sensor should be the tallest object in the area to avoid reduced wind speed values.

## RAIN

Mount in an open area, preferably off the ground on a level platform.

- Clean out the bucket regularly to avoid debris; this can affect readings.

## THERMO-HYGRO

Keep out of direct sunlight & ensure the sensor is well-ventilated.

- We recommend mounting it on a north-facing wall under an eave or deck for best results.

For detailed sensor setup and mounting instructions, see [page 25](#).

# BUTTON FUNCTIONS

Buttons located on top of Professional Weather Station

RAIN	WIND	TEMP	+	SET	-	EXTRA SENSOR	SENSOR	LIGHT
------	------	------	---	-----	---	-----------------	--------	-------

Buttons located on the right side of Professional Weather Station

DAILY	HOURLY
-------	--------

SET	Hold for basic setting. Press to view Wi-Fi status.
TEMP, WIND, RAIN	Press to view history.
LIGHT	Press to adjust brightness. Hold to set Auto Dim.
+ or -	Use + or - to adjust values in settings.
+ & -	Hold both buttons to search for Wi-Fi.
SENSOR	Press to view sensor ID numbers, then hold PLUS (+) to search, or hold MINUS (-) to remove.
DAILY, HOURLY	Press to see forecast. Must be connected to Wi-Fi.
RAIN & LIGHT	Hold both buttons together to reset all sensor ID's and Wi-Fi settings.
EXTRA SENSOR	Press to toggle through "extra sensor" & Barometric Pressure. Hold to add Sensors.

# WEATHER STATION ICONS

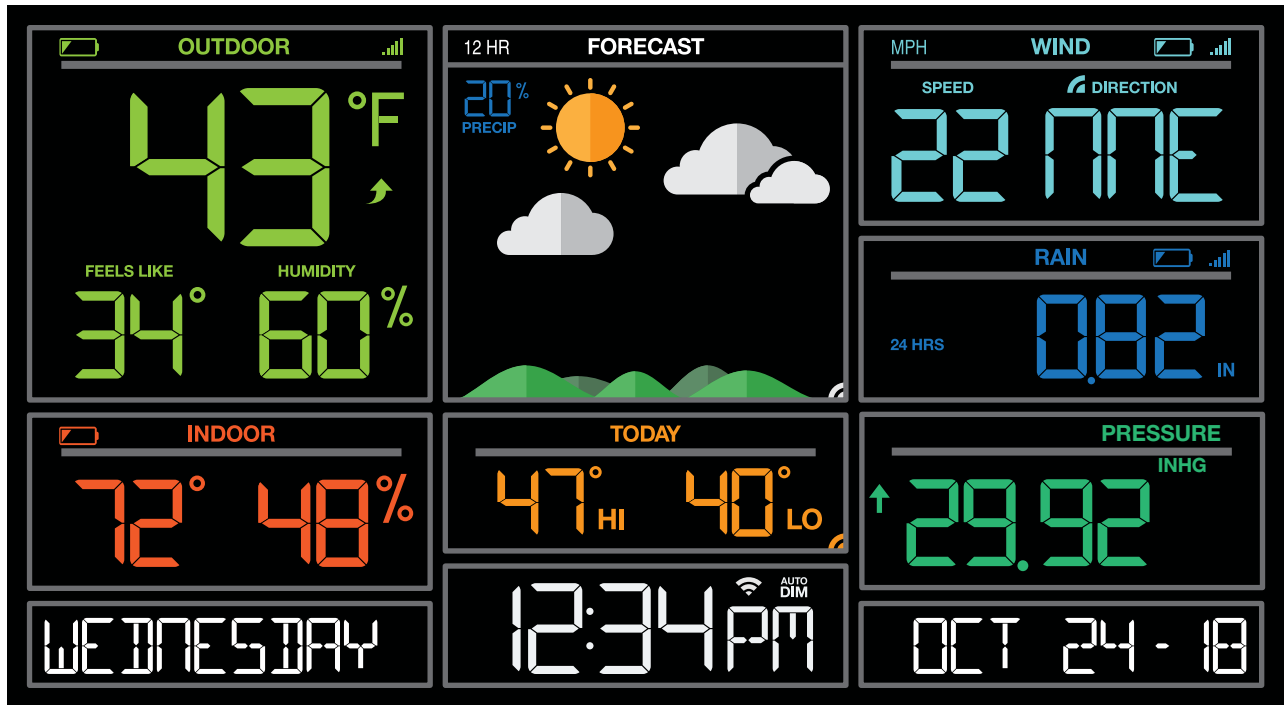



  
Low Battery  
Indicator

  
Sensor  
Reception

  
Temperature  
Trend Arrows

  
Fahrenheit  
Celsius

  
Percent  
Humidity

  
12 Hour  
Forecast

  
Chance of  
Precipitation

  
Forecast  
Indicators

  
Internet  
Indicator

  
Wi-Fi  
Indicator

  
MPH / KMH  
Miles or  
Kilometers

  
IN / MM  
Inches or  
Millimeters

  
INHG / HPA  
Inches of Mercury  
or Hecto Pascal

  
Pressure  
Trend Arrows

  
AUTO  
DIM  
Auto Dim  
Indicator

## EXTRA SENSOR AREA ICONS:

- The Extra Sensor area of your station will default to Pressure when you first power up.
- When you choose to add additional sensors, the Sensor Reception Indicator will show in the upper left corner whether Pressure or Sensor reading is displayed.
- Press and release the EXTRA SENSOR button to view all additional sensors.

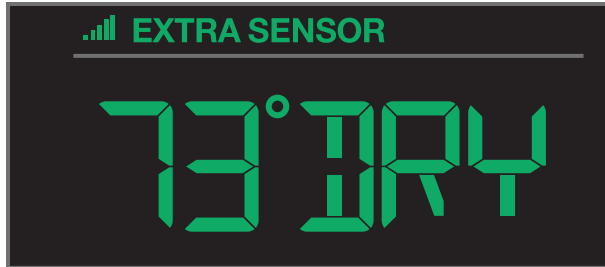

INHG / HPA  
Inches of Mercury  
or Hecto Pascal



Pressure  
Trend Arrows



Low Battery  
Indicator



Sensor  
Reception



Auto Scroll  
Pressure/Sensors



Probe  
Reading

## CONNECT TO LA CROSSE VIEW™ APP

### MOBILE DEVICE REQUIREMENTS

#### iOS Requirements:

Mobile device with iOS with cellular or Wi-Fi service

#### Android Requirements:

Mobile device with Android OS with cellular or Wi-Fi service

### GET YOUR STATION READY

Ensure your station's Wi-Fi Indicator  is flashing. If it is not, press and hold the Plus (+) and Minus (-) buttons down together until it begins flashing. This tells you that your station is ready to connect.

### DOWNLOAD

Visit the App Store or Google Play Store to download the free La Crosse View™ app onto your mobile device.



### LAUNCH & FOLLOW

Open the La Crosse View™ app and follow the on-screen instructions.

### HAVING TROUBLES CONNECTING?

Make sure your mobile device is connected to your router's 2.4GHz Wi-Fi network, and that you've correctly entered your Wi-Fi password.

For more troubleshooting tips and support visit: [www.lacrossetechnology.com/lacrosseviewsupport](http://www.lacrossetechnology.com/lacrosseviewsupport)

- Your station's device ID can be found on the back of the display.
- Within 15 minutes after your station connects to the La Crosse View app, you should receive notifications to add your sensors. These will display in your app's Notification Center.

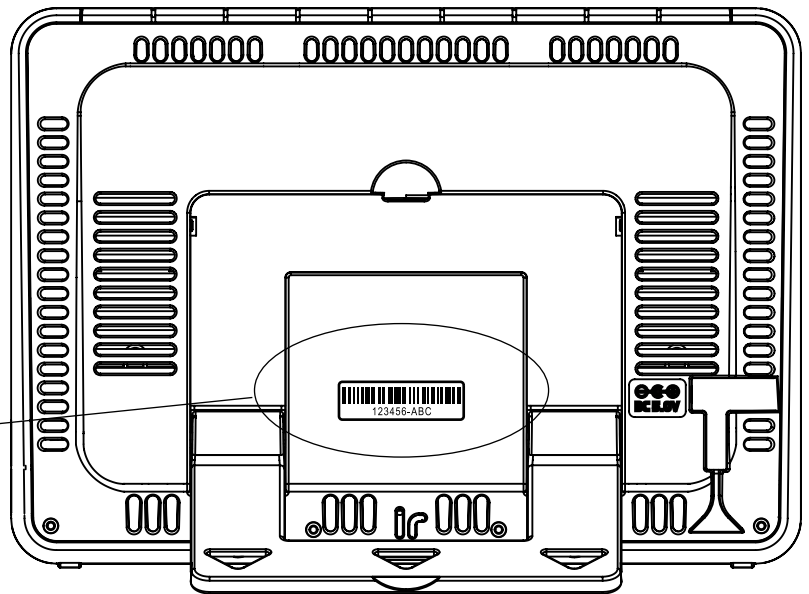

When your sensors are ready to be added, you'll see your app's cloud turn red. Press this Cloud Icon to begin adding your sensors.

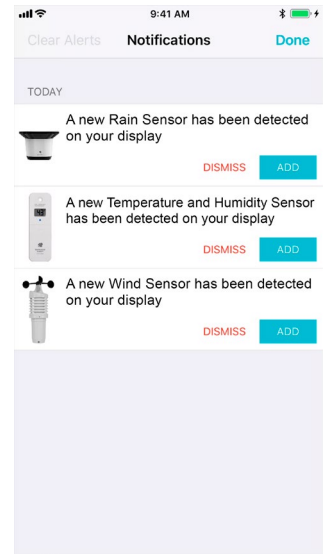
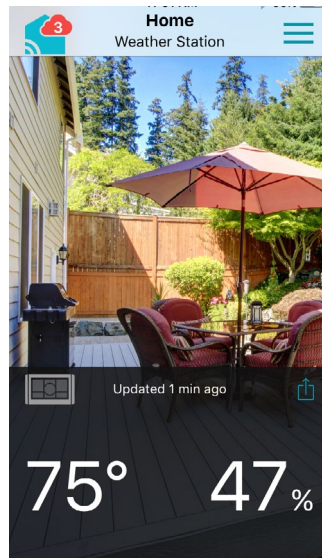
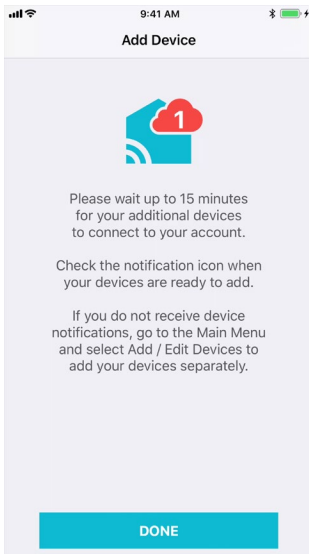

# BENEFITS OF CONNECTING TO LA CROSSE VIEW™



Connecting You to Your Home **Anytime, Anywhere.**

FEATURES	STANDALONE	CONNECTED
Wind Speed	✓	✓
Wind Direction		✓
Rainfall Data	✓	✓
Indoor & Outdoor Temperature	✓	✓
“Feels Like” Temperature	✓	✓
Indoor & Outdoor Humidity	✓	✓
12-Hour Forecast	✓	✓
Barometric Pressure	✓	✓
Internet Time and Calendar		✓
Advance Forecast Icons		✓
Daily Forecast HIs & LOs		✓
% Chance of Precipitation		✓
Ability to Add Sensors	✓	✓
Data Stream Technology		✓
Remote Monitoring		✓
Set Alerts		✓
View Graphs		✓



# ENHANCED LACROSSE VIEW CONNECTED FEATURES.

- Advanced Forecast Icons & Chance of Precipitation (12 Hour Forecast)
- AccuWeather Daily & Hourly Forecasts
- AccuWeather HI/LO Temperatures
- AccuWeather Wind Direction
- Custom Data Streams

## ADVANCED FORECAST & CHANCE OF PRECIPITATION

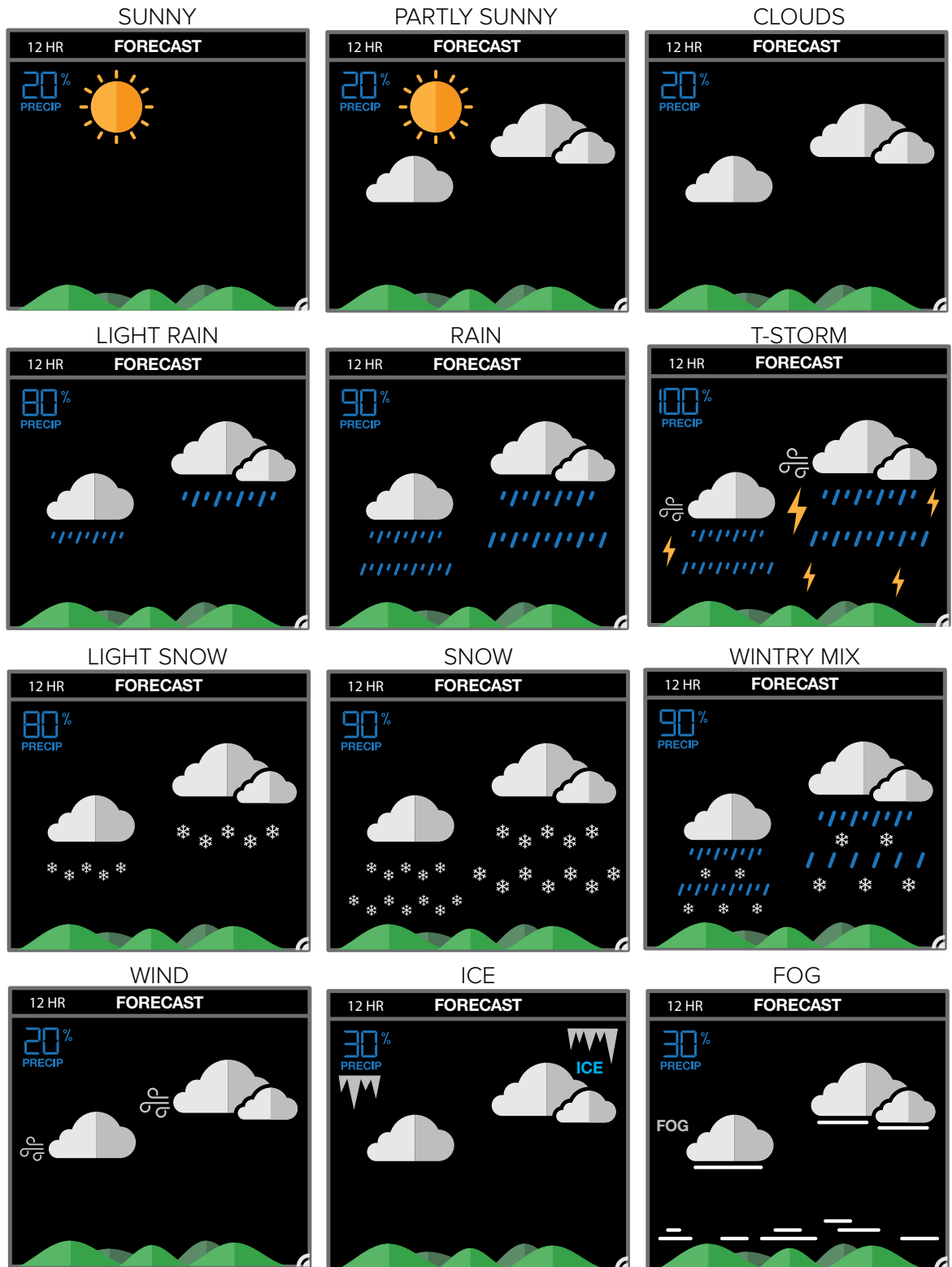

# ACCUWEATHER DAILY FORECASTS

Press the DAILY button on the side of your station to scroll through 7 days of future forecasts. You'll see changing forecast icons, HI/LO Temperature readings.

**IMPORTANT:** After viewing your Daily Forecast, the display will automatically revert back to the default 12 hour forecast after 10 seconds.

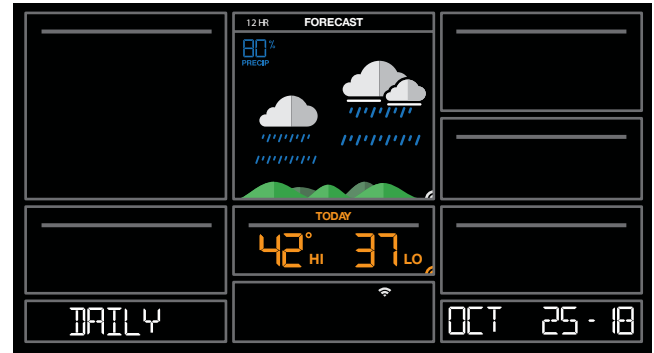
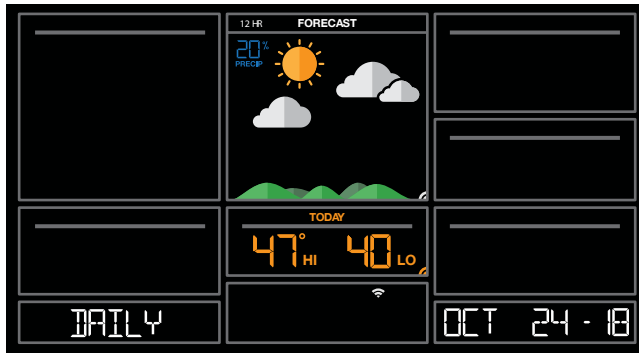

# ACCUWEATHER HOURLY FORECAST

Press the HOURLY button on the side of your station to scroll through 12 hours of future forecasts. You'll see hourly changes in:

- Weather Icons
- Chance of Precipitation
- Temperature
- Wind Direction

**IMPORTANT:** After viewing your Hourly Forecast, the display will automatically revert back to the default 12 hour forecast after 10 seconds.

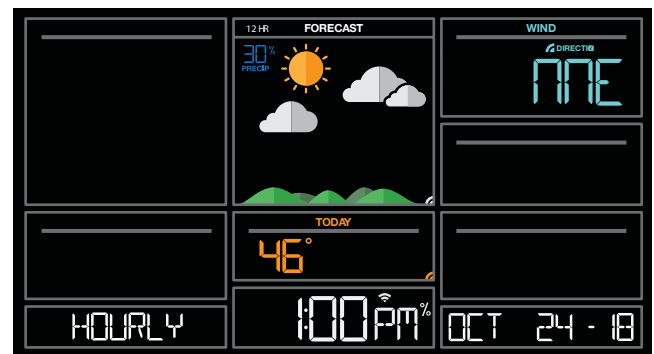
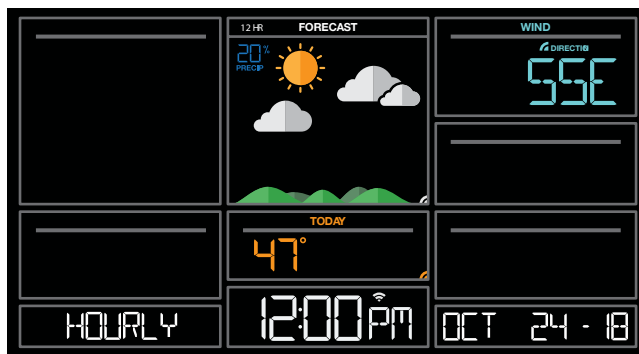

**Note:** If you press the HOURLY or DAILY button when not connected, station will say CONNECT TO WIFI. If your station is connected, but happens to lose connection with the weather service, it will say WAIT FOR WEATHER when your HOURLY or DAILY button is pushed.

## IMPORTANT:

There may be small discrepancies between data displayed on your station and data shown through other AccuWeather services, such as their website and/or mobile app. This is common, as there are differences in the timing in which forecast data is fetched by these items. Our connected weather stations will receive forecast updates at least 4 times daily.

# ACCUWEATHER HI/LO TEMPERATURES

TODAY Shows

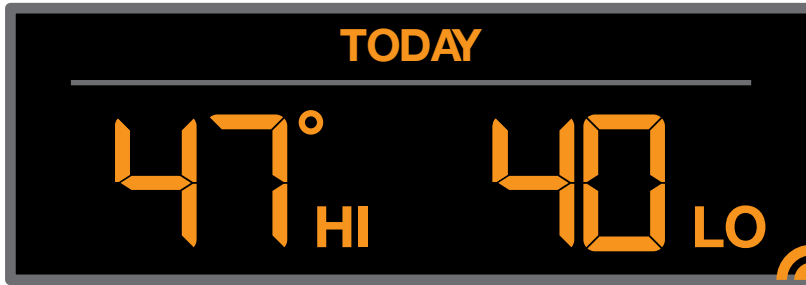

Internet Indicator will appear in bottom right corner when connected.

- When connected, your daily AccuWeather HI/LO Temperature predictions will display in this section.
- If unconnected, this section will display your Outdoor Temperature Records registered daily by your Thermo-Hygro Sensor. These will automatically reset at Midnight everyday.

# ACCUWEATHER WIND DIRECTION

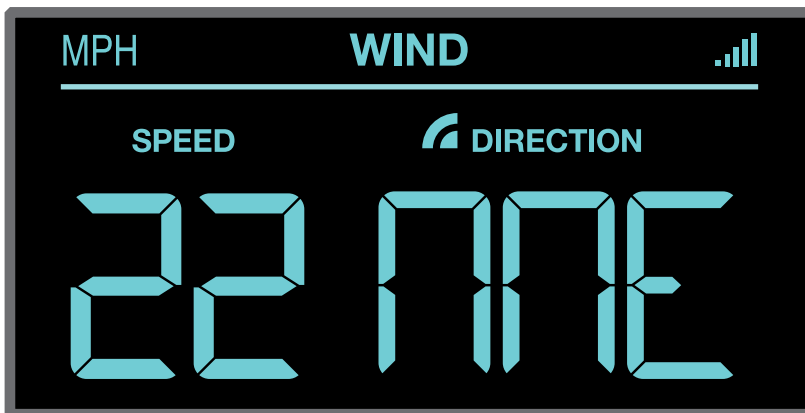

Internet Indicator Appears and Wind Direction replaces Top 1HR

# CUSTOM DATA STREAMS

Use the Data Stream Menu in the La Crosse View™ app to select up to 3 items to stream on your station.

1. Open the La Crosse View™ app and swipe until you find your station's device page.
2. Scroll down to the Data Stream section and press the blue stream icon in the upper right.
3. Follow the app's instructions to customize your "Data Stream" to display on your station

**Note:** Allow up to 10 minutes for new Data Stream selections to appear on your station.

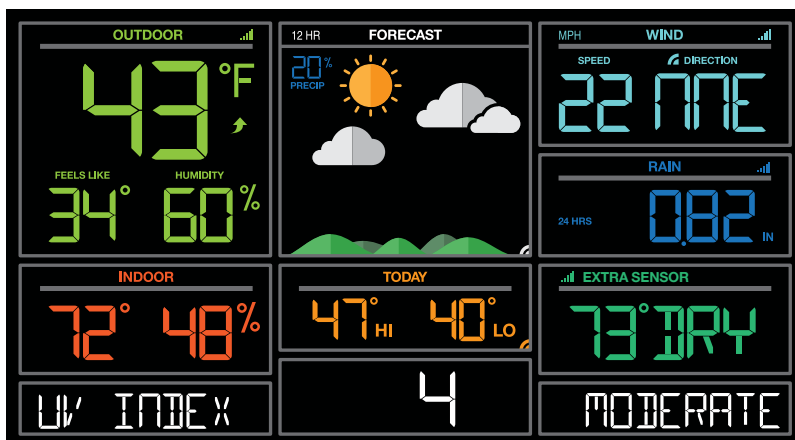

Custom Data Stream

## Data Stream Items:



Customizable Data Streams to enhance your in-home display:

Wind Speed • Wind Direction • Wind Gust • UV Index • Visibility • Dew Point • Percentage of Clouds • Sunrise Time • Sunset Time • Hours of Sunlight • Moon Rise Time • Moon Set Time • Temperature/Humidity • and more!

## Personal Messages

Enter up to 20 characters for special events or reminders, such as:

• SOCCER TONIGHT • ICE CREAM IN FREEZER • GREAT JOB MATH TEST or anything you can think of!

**Note:** Allow up to 10 minutes for new Data Stream selections to appear on your station.

## ADDITIONAL SENSORS CAN READ TO YOUR APP

### How to add Sensors to your La Crosse View App only:

1. Install batteries in the sensor, and if the sensor has a TX button, press the TX button to force a signal.
2. Scan sensor bar code ID so it will read in the La Crosse View app.

**Details:** Open your La Crosse View app to add sensors. Watch the video for adding devices to the La Crosse View app: [http://bit.ly/LaCrosseView\\_Support\\_Vid\\_10](http://bit.ly/LaCrosseView_Support_Vid_10)



1. From Main Menu - select “Devices” under “Add/Edit”
2. On Edit Devices page - select “ADD DEVICE”
3. Scan Device ID - Scan the bar code on your sensor or choose “ADD MANUALLY” to type in the number on the bar code. Select “CONTINUE”.
4. On Confirm Device page - Confirm the sensor image and select “YES”
5. On Enter Device and Location Name page - enter Device Name and select a location or enter a Location Name for your sensor. Select “DONE”.

Repeat steps 1-5 for any additional sensors you wish to add.

**Purchase Additional Sensors:** For additional sensors to read to your station or to the app visit the **PARTS TAB** at: <http://bit.ly/C83100>

# STATUS MESSAGES WHEN CONNECTED

## Quick Tip:

- The Wi-Fi Icon  indicates Wi-Fi connection- not necessarily app connection.
- The Internet Icons  by your Forecast, Wind Direction and HI/LO Temperatures will indicate connection to the La Crosse View App and Weather Server.

Status Messages on you station will let you know if there are issues.

Press and release the SET button to view the status of your station.

## ALL OK CONNECTED

- Station is connected all the way through to the La Crosse View app.

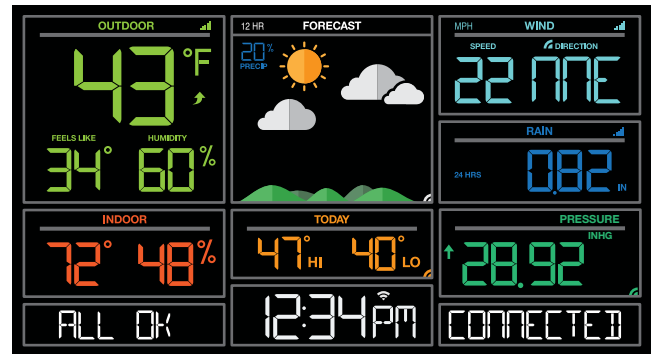

## CHECK APP

- The Wi-Fi router connection is working.
- Check your connection to the La Crosse View app.
- Check Notifications in the La Crosse View app
- Is there an update to install?

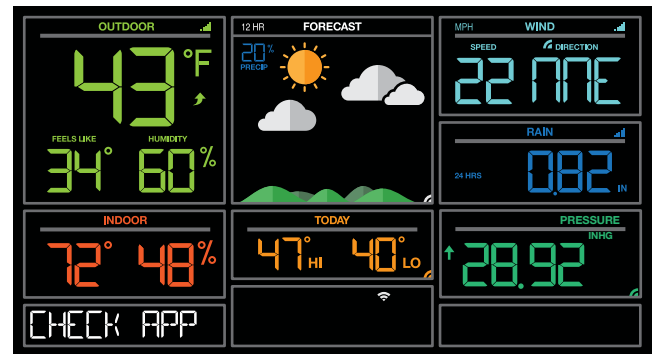

## LOST WIFI

- Check your power cord connection (power cord required to connect)
- When trying to reestablish your station's Wi-Fi connection, be sure your mobile device is on the same 2.4GHZ network you want your station to use.
- Check your network connection.
- Hold the + and – buttons together for 3 seconds to search for Wi-Fi.

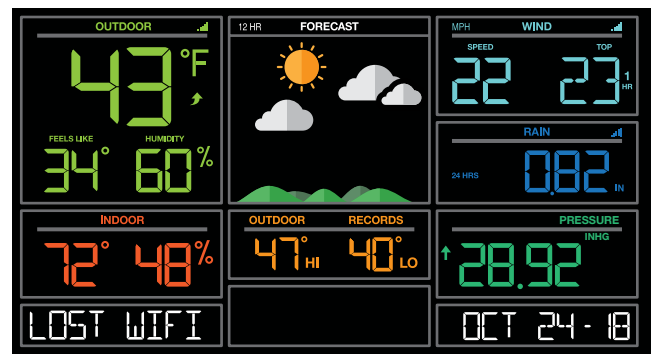

## NO WEATHER SERVICE

- Wi-Fi, and App are fine.
- Weather/Time service not connecting. This will be resolved at the Weather Server. Please be patient.
- Weather Forecast, Precipitation and Weather HI/LO temperature will not be displayed.

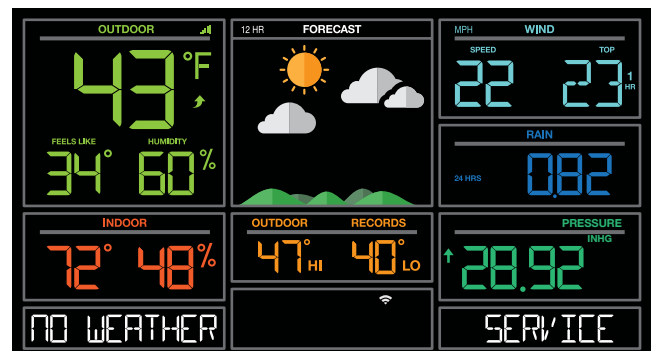

# FEATURES OF YOUR WEATHER STATION

Your station provides most functionality when connected to the La Crosse View app. However it is fully functional as a **standalone station**.

**Here we have included the details for various functions of your station:**

- Adjustable Backlight
- Auto Dim Backlight
- Settings Menu
- Extra Sensor Area
- Wind Speed Readings and History
- Rainfall Readings and History
- Temperature/Humidity Readings and HI/LO Records
- Feels Like Temperature
- Temperature Trend Arrows
- Relative Barometric Pressure
- Low Battery Indicators
- Sensor Reception Indicator
- Sensor ID's and Sensor Search
- Delete Sensor
- Factory Restart Station
- Bonus Station

## ADJUSTABLE BACKLIGHT

Your station has 5 levels of brightness for the backlight:

- Press and release the LIGHT button to adjust the backlight at 5 levels of intensity.  
Levels: OFF = 0% | level 1 = 15% | level 2 = 20% | level 3 = 50% | level 4 = 100%.

## AUTO DIMMING BACKLIGHT

You can set your backlight to automatically dim to level 1 at a set hour for sleeping, then automatically return to full brightness when you wake.

**Set Auto Dim (Hour only):**

1. Hold the LIGHT button 2 seconds to enter dimmer set mode. AUTO DIM OFF will show.
2. Press the + or – buttons to turn dimmer (ON). AUTO DIM ON will show.
3. Press the LIGHT button to select start time (Hour) for dimmer. AUTO DIM START TIME and the hour will flash.
4. Press the + or – buttons to change the hour for the dimmer to be low light level.
5. Press the LIGHT button to select start time for dimmer to be on High light level. AUTO DIM STOP TIME and the hour will flash.
6. Press the + or – buttons to change the hour for the dimmer to be high light level.
7. Press the LIGHT button to confirm exit.

**Note:** Hold LIGHT button at any time to exit dimmer settings.

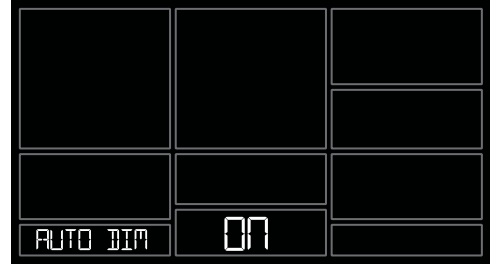
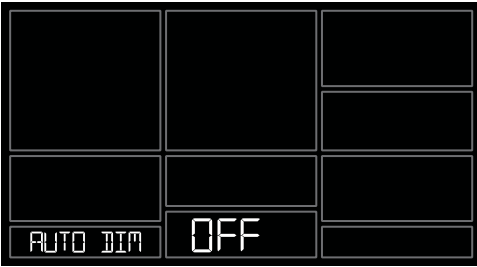

**Note:** If you press the LIGHT button to manually adjust the backlight, the Auto Dim feature will resume at the next scheduled time to dim.

## SETTINGS MENU

1. Hold the SET button for 3 seconds to enter settings menu.
2. Press and release the + or - buttons to adjust the flashing values. Hold to adjust quickly.
3. Press and release the SET button to confirm and move to the next item.

**Note:** Press and release the LIGHT button any time to exit settings.

### Settings menu order:

- BEEP ON | OFF
- 12/24 hour format
- Hour
- Minutes
- Year
- Month
- Date
- Temperature Fahrenheit | Celsius
- Pressure: InHg / hPa
- Pressure number setting



**Note:** Weekday sets automatically as Year, Month and Date are set.

# EXTRA SENSOR AREA

The Extra Sensor area of your station will show Relative Pressure when you first power up.

**Optional Extra Sensors:** Up to 4 additional Thermo-Hygro, Wind Speed, Water Leak or any combination of these sensors can read to the EXTRA SENSOR area of your display. Simply press and release the EXTRA SENSOR button to view these sensors or turn on Auto Scroll.

**Note:** The Extra Sensor area cannot read Rain sensors.

**Purchase Extra Sensors:** For additional sensors to read to your station or to the app visit the **PARTS TAB** at: <http://bit.ly/C83100>

**Note:** Not all sensors will read to the station. Be sure to check the chart to see if a sensor can read to the app only, or both station and app.

Relative Pressure (default)



Temperature/Humidity

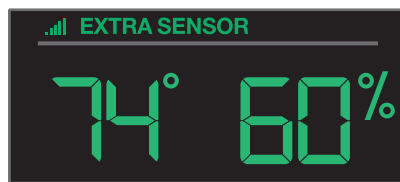

Contact Probe

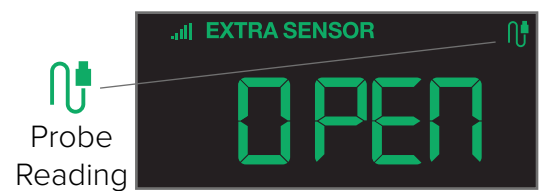

Wind Speed

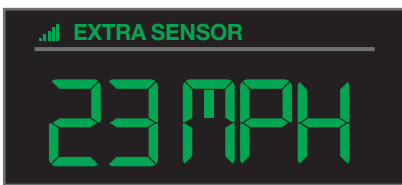

Water Leak

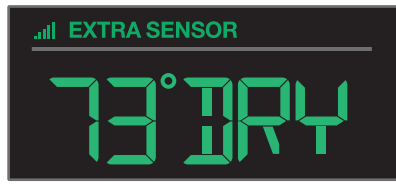

Auto Scroll all Extra Sensors

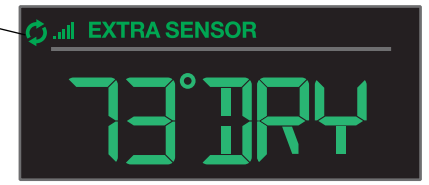

## Add Extra Sensors to your station:

1. Hold the EXTRA SENSOR button 3 seconds, to add a sensor to the station.
2. Install batteries in the sensor, and if the sensor has a TX button, press the TX button to force a signal.
3. Allow up to 3 minutes to view sensor and ID on station.

**Note:** Once sensor is found the search will stop. Sensor, ID, and type will show for 3 seconds then return to normal display.

4. Scan sensor bar code ID so it will read in the La Crosse View app.
5. Added sensors will be available for display in Extra Sensor area of station.



1. Hold the EXTRA SENSOR button
2. Install batteries in the sensor
3. Press TX button
4. Allow up to 3 minutes to connect
5. Scan sensor bar code ID

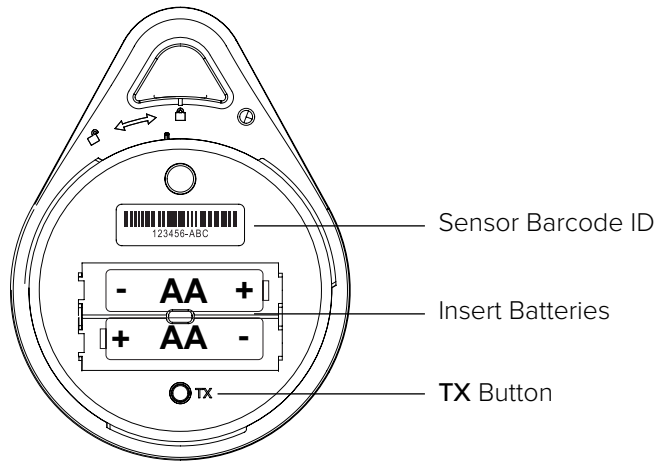

Station normal display-Pressure showing

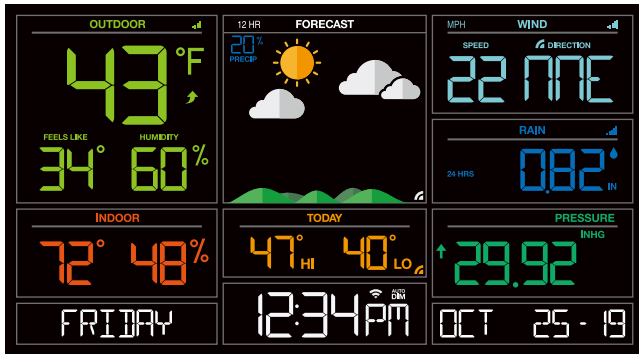

Water Leak sensor added



**Delete Extra Sensors from your station:**

1. Press and release the EXTRA SENSOR button until you see the sensor and ID you wish to delete.
2. Hold the MINUS (-) button for 3 seconds to delete this sensor. The sensor readings and ID will show dashes.
3. Sensor will no longer show in the Extra Sensor area.



Press and release the EXTRA SENSOR button to view Pressure, and any Extra Sensors connected to your station.

# WIND SPEED READINGS & HISTORY

**Current Speed:** Highest wind speed in past 31 seconds. Samples every 3 seconds

**Top Speed (1 HR):** Highest wind speed in past 60 minute period.

**Wind Direction:** When connected wind direction in letters will replace Top 1HR. Top 1HR will still be viewable in history. Internet Indicator will show next to the word DIRECTION.

Not Connected: Current & Top Speed

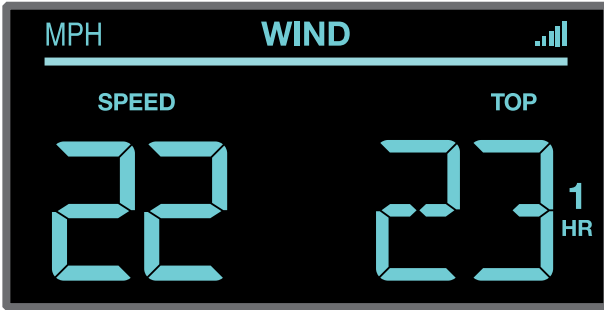

Connected: Current Speed & Internet Wind Direction

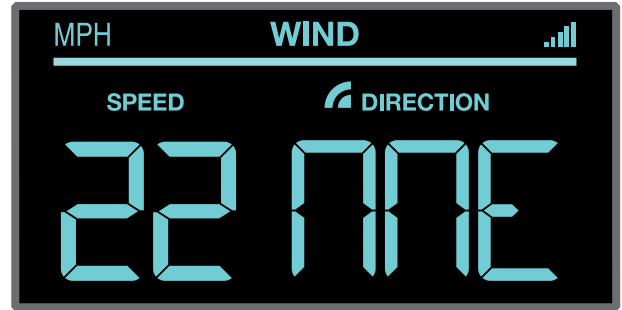

## Wind Speed History:

1. Press and release the WIND button to view the maximum wind history values (Top Speed).
2. When viewing MONTH history, press the PLUS button to toggle through the current month and past 11 months top speed.

**Note:** All other readings will disappear for 5 seconds.

**1 Hour:** Highest wind speed in past 60 minute period.

**24 Hours:** Highest wind speed in past 24 hour period, from last record, with time/date stamp. This is a running total.

**7 Days:** Highest wind speed in past 7-day period, from last record, with time/date stamp. This is a running total.

**Month:** Highest wind speed in for the month with time/date stamp

- o Current Month: First day to current day.
- o Previous 11 months. Defined by Calendar Month i.e. January 1 - January 31

**Year:** Highest wind speed in Current Year. Defined by Calendar Year i.e. January 1 - December 31

Top speed for the year with time/date stamp

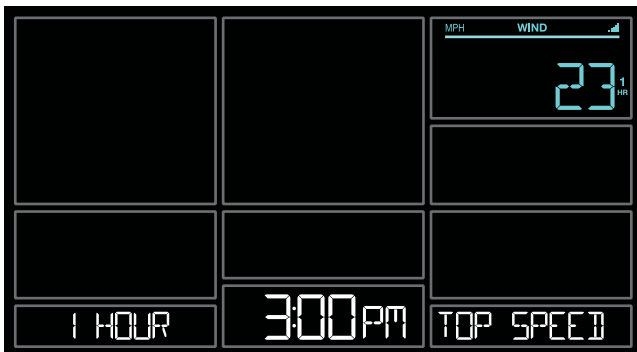



### Reset Wind Speed History:

1. Press the WIND button to view individual wind speed readings.
2. Hold the MINUS button for five seconds to reset the individual value.
3. Wind speed reading will reset to current wind speed, time and date.

## RAINFALL READINGS & HISTORY

1. Simply press and release the RAIN button to cycle through the exact rain history you'd like displayed (other readings will disappear temporarily). Your station will stay on your selection.
2. Press and release the LIGHT button, or wait 20 seconds to return to a full, normal display.

### NOW:

- Shows Rain readings from the start of a rain event until no rain has accumulated for 30 minutes.
- After a 30 minute period of no rainfall, this number will reset to zero.

### 1 Hour:

- Rainfall in the past 60 minutes (last twelve 5 minute samples).
- Example: current time is 6:49, 1HOUR is the accumulated rain between 5:50 to 6:49.

### 24 Hours:

- Rainfall for the past 24 hours. Updates at each full hour. This is a running total.

### 7 Days:

- Rainfall from the last 7 consecutive 24 hour rainfall readings.
- Updates each day at 12am midnight. Not subject to your calendar, but be sure you have your time set correctly.

### Month:

- Current Month: First day to current day. Current month (MAY) will show.
- Press and release the PLUS button to view previous months.

### 1 Year:

- Current month plus past 11 months total. Current year will show.

### Total:

- Total rainfall since station was powered on or reset.

**Note:** As time passes without rain, the 1 hour, 24 hour, and 7 day rain totals will count down to zero.

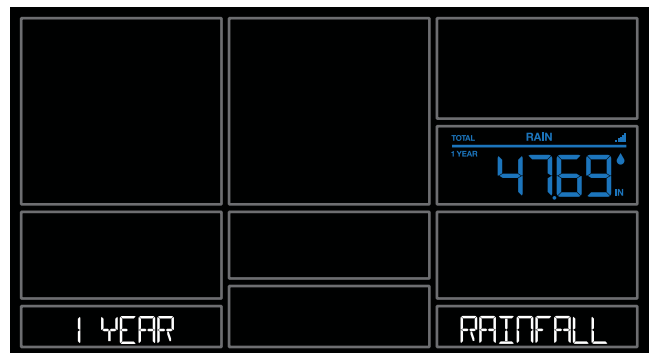

### Reset Rainfall History:

1. Press and release the RAIN button to view individual rain readings.
2. Hold the MINUS button for five seconds to reset the individual value.
3. Rain reading will reset to zero.

# TEMPERATURE/HUMIDITY READINGS & HI/LO RECORDS

Your current Indoor and Outdoor temperature and Humidity are constantly displayed on your weather station. Your station records your HI and LO Temperature and Humidity with time and date of occurrence.

1. Press and release the TEMP button to view your HI and LO records with time and date of occurrence.
2. Any new HI or LO record will replace the existing record.

## Viewing order:

- Outdoor HI Temp with Time/Date
- Outdoor LO Temp with Time/Date
- Outdoor HI Humidity with Time/Date
- Outdoor LO Humidity with Time/Date
- Indoor HI Temp with Time/Date
- Indoor LO Temp with Time/Date
- Indoor HI Humidity with Time/Date
- Indoor LO Humidity with Time/Date
- Feels Like HI Temp with Time/Date
- Feels Like LO Temp with Time/Date
- Outdoor Dew Point

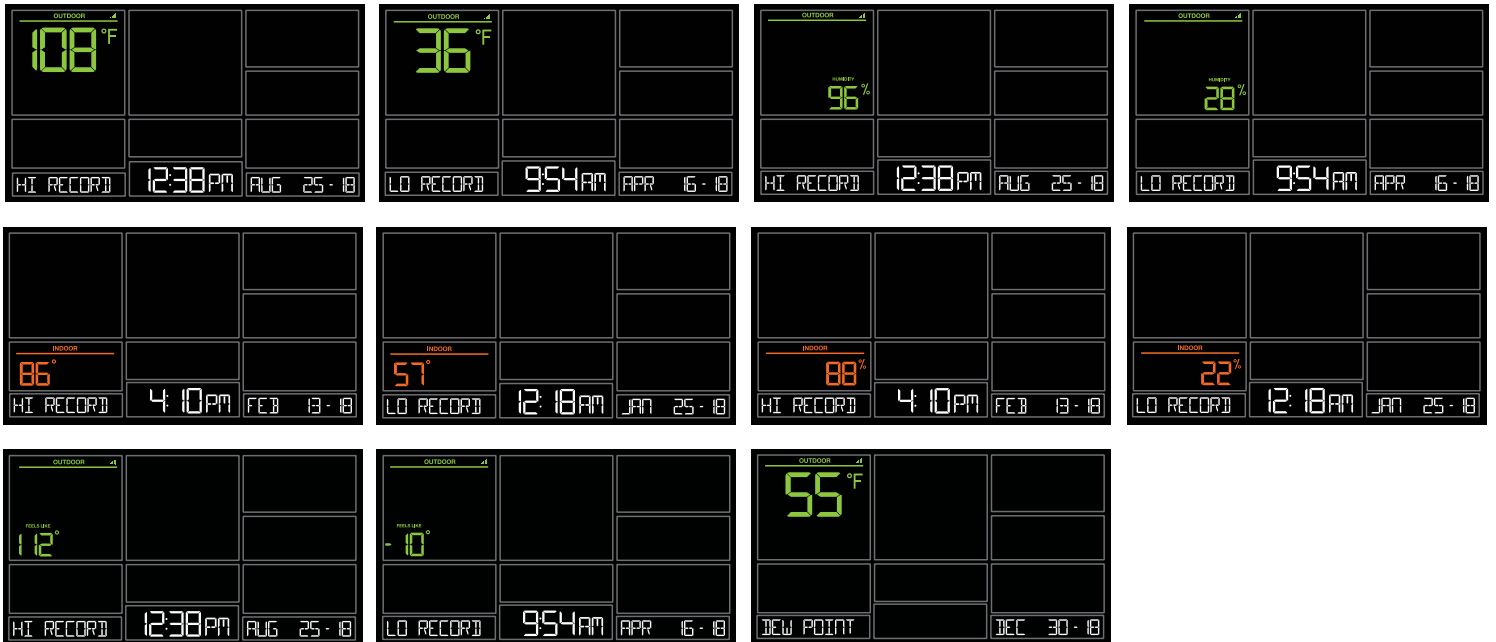

## Reset HI/LO Temperature/Humidity Records:

1. Press and release the TEMP button to view individual temperature/humidity readings.
2. Hold the MINUS button for five seconds to reset the individual value.
3. Temperature and Humidity readings will reset to current temperature, humidity, time and date.

## FEELS LIKE TEMPERATURE

Your “Feels Like” Temperature is a combination of outdoor temperature, humidity and wind speed. It is displayed in the Outdoor Temperature area.

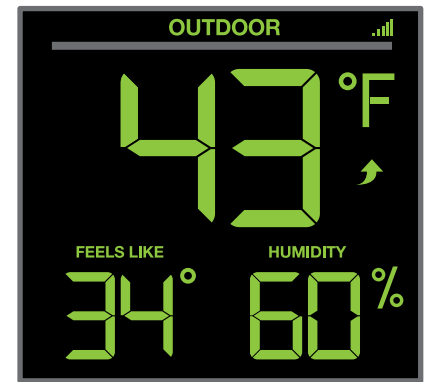

- When outdoor temperature is higher than 80°F, your Feels Like Temperature is showing Heat Index.
- When outdoor temperature is lower than 50°F, your Feels Like Temperature is showing Wind Chill.
- When outdoor temperature is between 50°F and 80°F, your Feels Like Temperature will show Current Outdoor Temperature.



**Note:** When you have a high humidity reading, but the temperature is not over 80°F, the Feels Like Temperature will remain the same as the current outdoor temperature.

## TEMPERATURE TREND ARROWS

Your Outdoor Temperature Trend Arrows update every 15 minutes. The trend reflects changes over the past one hour period.

-  UP ARROW: For this to show, the temperature will have to rise by 2°F (1°C), or more within the current hour.
-  RIGHT ARROW: Temperature is steady
-  DOWN ARROW: For this to show, the temperature will have to fall by 2°F (1°C), more within the current hour.

## RELATIVE PRESSURE READING

- Your station itself has a Pressure Sensor inside to provide accurate Relative Pressure readings.
- The station will default to a Relative Pressure of 29.92 Inches of Mercury.
- Give it up to 3 days to automatically adjust to your environment.
- The Relative Pressure number is programmable in the Settings Menu.
- You can select INHG (Inches or Mercury) or HPA (Hecto Pascal) for Pressure units in the Settings Menu.
- The UP and DOWN Arrows indicate the Pressure Tendency (rising or falling). This is calculated when the average value of the current hour’s barometric pressure is compared to the average of the past 3 hours. If the difference is greater than +1hpa, the air pressure trend will increase; if the difference is less than -1hpa, the air pressure trend will decrease; if it is between +1 and -1hpa, it will be flat.

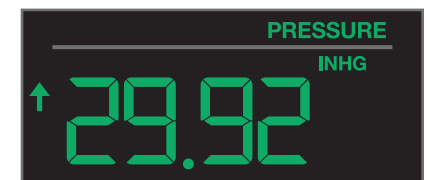

**Note:** If you choose to add Extra Sensors, simply press and release the EXTRA SENSOR button to switch between the sensor reading and Relative Pressure reading.

# SENSOR RECEPTION INDICATORS

There are Sensor Reception Indicators for your Temperature/Humidity Sensor, Wind Sensor and Rain Sensor. If you add Extra Sensors, There will be a Sensor Reception Indicator for them as well.

- When indicator is solid, sensor is connected.
- When indicator is flashing, it is searching for the individual sensor.
- If there is no indicator, the sensor is not connected.

# SENSOR ID & SENSOR SEARCH

Your station and each sensor have a unique ID number that will identify them in the La Crosse View app. This has the added bonus of locking them into your weather station until you manually delete them.

## View ID numbers in station:

Press and release the SENSOR button. The ID number and type will show on the bottom of the station.

- Station
- TH Sensor
- Wind Sensor
- Rain Sensor
- Extra Sensor (if connected to station)

## Search for Individual sensors:

1. Press and release the SENSOR button to view sensor type and ID.
2. Hold the PLUS (+) button to search for the sensor. The reception indicator will flash for up to 3 minutes.
3. Allow up to 3 minutes to view sensor and ID on station.

**Note:** Once sensor is found search will stop. The reception indication will stop flashing.

Sensor and ID will show for 3 seconds.

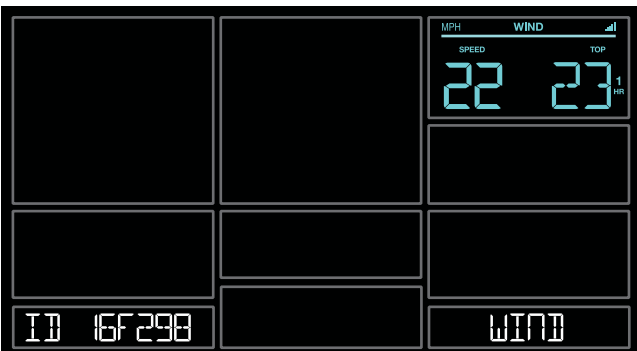
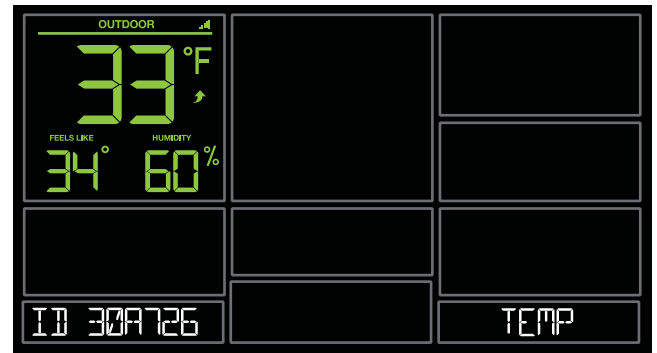

## DELETE SENSORS

1. Press and release the SENSOR button to view sensor type and ID.
2. Hold the MINUS button to delete the sensor from the station.
3. Deleted sensor can no longer show on station. Batteries should be removed.
4. Station will automatically search for a replacement sensor of the same type.

**Example:** Delete a Wind sensor, the station will search for a new Wind sensor.

5. If replacing a sensor, insert batteries into the new sensor. Once station receives sensor, press the SENSOR button to confirm sensor ID.

**Note:** Deleted, working, Sensors with batteries installed, may still pass through to the app but will no longer show on the station.

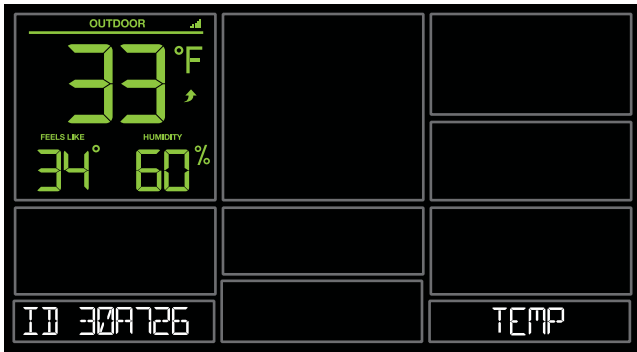

## LOW BATTERY INDICATORS

- Low battery by Outdoor Temperature, replace batteries in the TH sensor.
- Low battery by Wind, replace batteries in the Wind Sensor.
- Low battery by Rain, replace batteries in the Rain Sensor.
- Low Battery by Indoor Temperature, replace batteries in Station.
- Low Battery by Extra Sensor, replace batteries in Extra Sensor.

## FACTORY RESTART STATION

A factory restart of your station will remove all sensor ID numbers and Wi-Fi settings and return it to its default settings and “out of the box” condition.

This may resolve connection issues with your sensors or Wi-Fi.

1. Hold the RAIN and LIGHT buttons together for 5 seconds.
2. Your station will reset and search for all sensors.
3. Allow up to 3 minutes to reacquire all sensors.
4. You will need to reconnect to your La Crosse View app by selecting CONNECT WIFI from the menu in your La Crosse View App and entering your Wi-Fi password.



# DETAILED SETUP & MOUNTING

## LTV-W1 Wind Speed Sensor

1. Turn the battery cover of your wind sensor to the left.
2. Install fresh “C” batteries.
3. Carefully align and turn battery cover right to tighten.
4. There is a blue LED light on the sensor that will flash when transmitting.

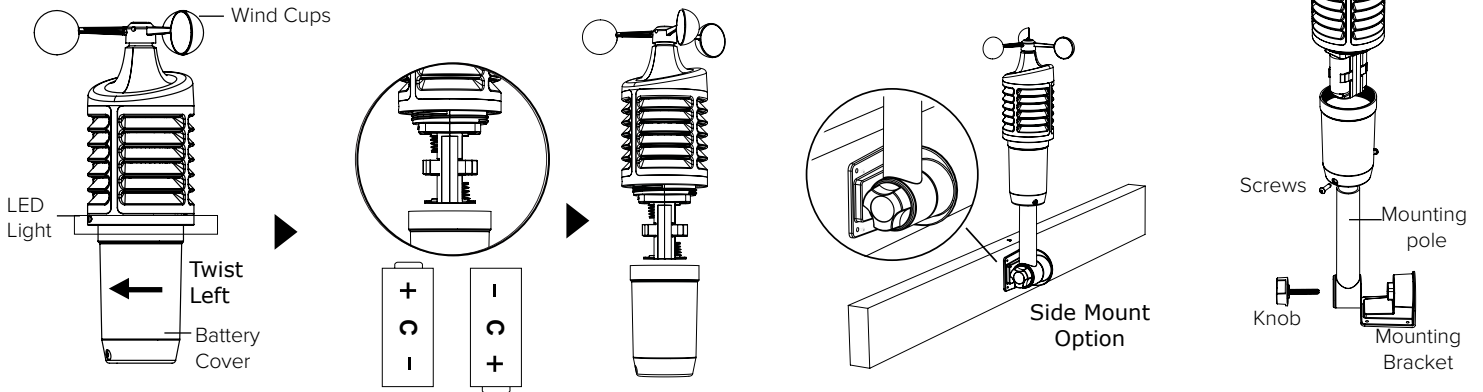

### Mounting:

- Position in an open area that will have the least amount of interference with wind speed.
- Mount your sensor vertically with the wind cups on top.
- The maximum wireless transmission range to the station is up to 400 feet (121 meters) in open air, not including walls or trees.

1. Use screws through the bottom of the mounting bracket to attach.
2. Insert bottom of pole into mounting bracket. Tighten knob to secure
3. Insert the included mounting pole into your sensor.
4. Tighten screws.

### Alternatively:

1. Insert your own mounting pole (no more than 1 inch outside diameter”) into the sensor.
2. Tighten screws

## LTV-R2 Rain Sensor:

1. Flip open both locking tabs on your rain sensor and lift off the funnel portion.
2. Pull up on the battery cover and remove.
3. Install 2-AA batteries according to polarity.
4. Reposition the battery cover over the battery compartment, and firmly push down to lock it back into place
5. Remove cardboard and any tape around the rocker before use. These were used to protect the sensor from unwanted movement during shipping.
6. Place the funnel portion back over the sensor and re-secure the locking tabs.

### Mounting:

1. Mount in an open area, on a stationary level platform for a more accurate rain count.

**Note:** Avoid placing the bottom of the rain sensor in a depression that would not allow proper water drainage.

2. Insert the mounting screws through the holes in the bottom of your rain sensor. Do not over tighten.
3. Mount your rain sensor at least 3 feet and optimally 6 feet in the air and in direct line of sight to your station.
4. Your rain sensor should be accessible to allow for periodic cleaning of debris or insects.
5. The maximum wireless transmission range to your station is up to 400 feet (121 meters) in open air, not including walls or floors.

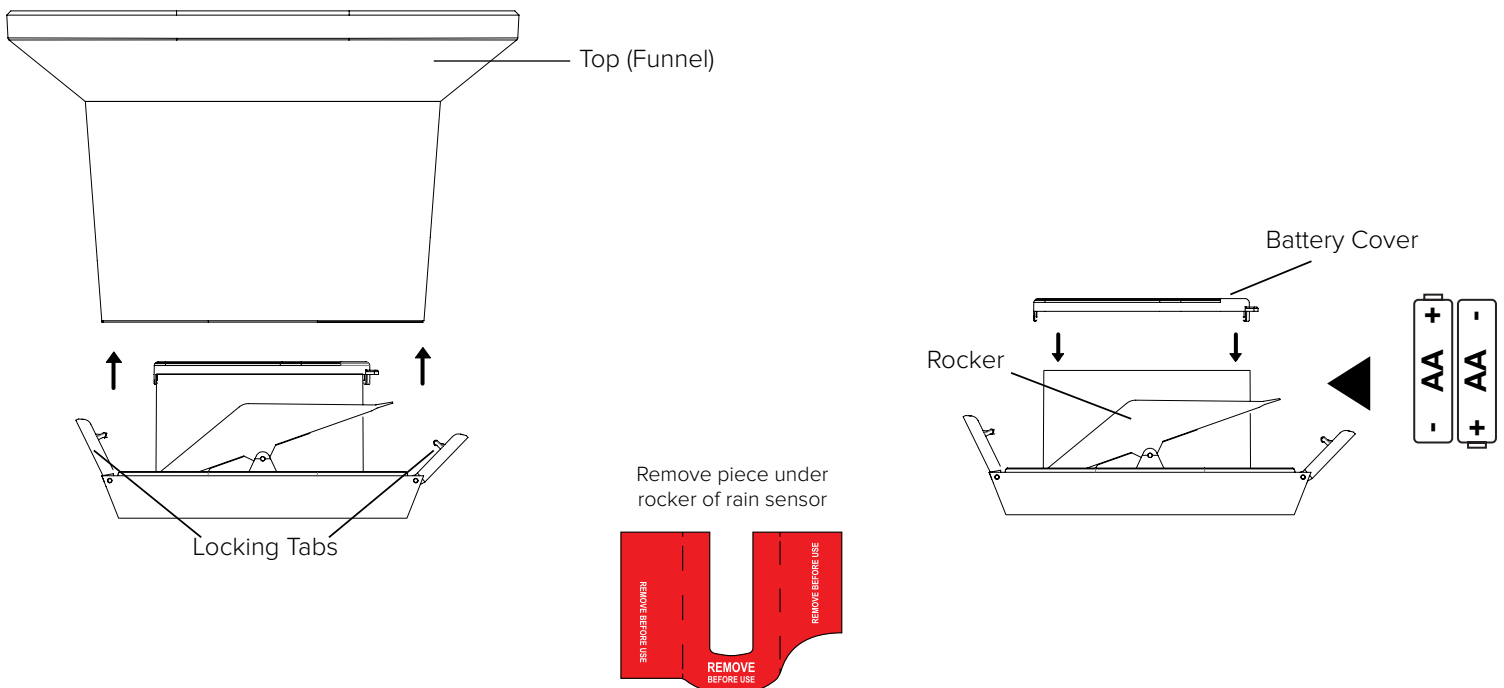

## LTV-TH2 Thermo-Hygro Sensor

1. Install 2-AA batteries according to polarity and replace battery cover.

### Mounting:

1. Use the hole at the top to hang your sensor from the back using a nail. Or, insert one mounting screw through the front of your sensor.
2. Mount your sensor on a north-facing wall or in any shaded area. Under an eave or deck rail is preferred.
3. The maximum wireless transmission range to the weather station is up to 400 feet (121 meters) in open air, not including walls or floors.
4. Be sure your sensor is mounted vertically, to allow moisture to drain out properly.

**Note:** Watch sensor mounting video: [http://bit.ly/TH\\_SensorMounting](http://bit.ly/TH_SensorMounting)

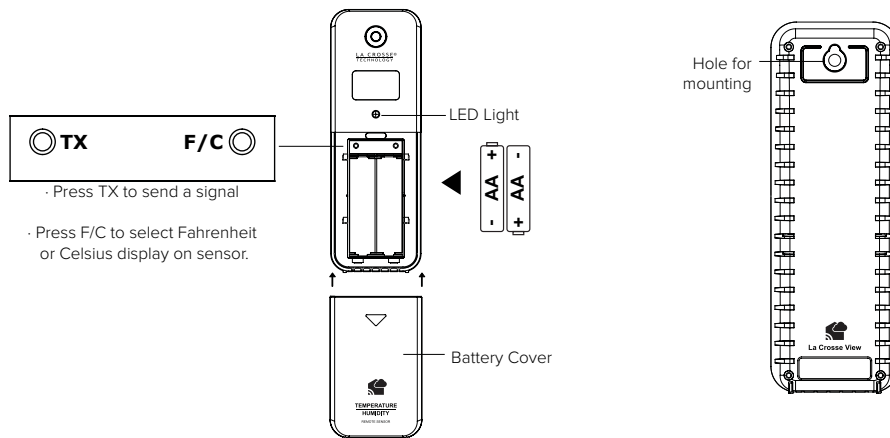

## C81300 Weather Station:

1. Insert the power cord into a wall outlet, then into your station. Remove the red insulation tab from the CR2032 battery installed in the bottom of your weather station to maintain time/date in the event of a power outage.

### Mounting:

1. Place your station near an outlet. Power cord is required for operation.
2. Use the mounting holes on the back to place your station on a wall.
3. Use the pull down stand on the back of your station to place on a desk or counter.
4. Your station should remain in good Wi-Fi range of your wireless router to use all the remote monitoring options using the La Crosse View app.

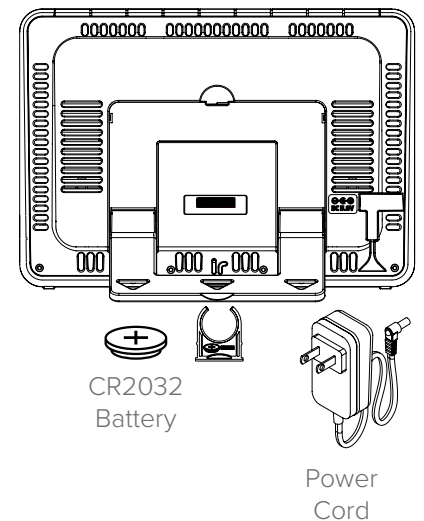

# BONUS STATION SETUP

As an added bonus, we've included an LTV-D1 Bonus Station to provide basic temperature and humidity readings in another room of your home. Your Bonus Station will receive its data from the included LTV-TH2 Thermo-Hygro Sensor.

## LTV-D1 Bonus Station:

1. Insert 2 AAA batteries into your Bonus Station according to polarity.

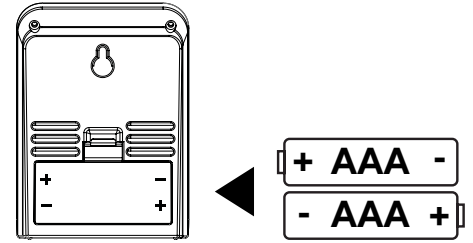

## Mounting:

1. Place your bonus station on a desk or counter top.
2. Use the mounting hole on the back to place your station on a wall.

## Settings Menu:

Your Bonus Station does not connect to La Crosse View and will need to be set manually:

1. Hold the SET/IN-OUT button for 3 seconds to enter settings menu.
2. Press and release the +/SEARCH button to adjust settings. Hold to adjust quickly.
3. Press and release the SET/IN-OUT button to move to next item

## Setting order:

- 12/24 Hour Time
- Hour
- Minutes
- Fahrenheit/Celsius

1. 12 | 24 Hr

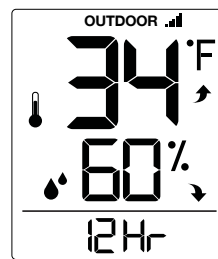

2. Hour

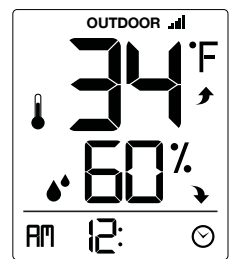

3. Minutes

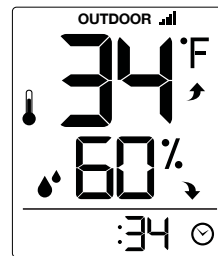

4. Fahrenheit | Celsius

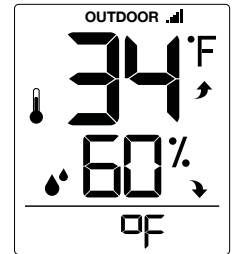

**Note:** This Bonus Station will not connect to the La Crosse View app.

## View Indoor or Outdoor Data:

Press and release the SET/IN-OUT button to switch between:

- Outdoor temperature/ humidity readings
- Indoor temperature/humidity readings

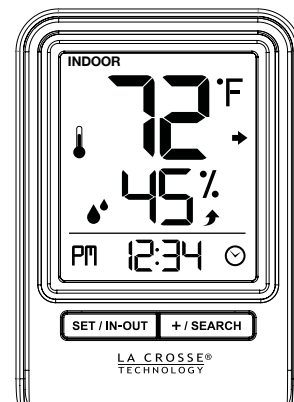

### Search for Outdoor Sensor:

In the rare event your Bonus Station loses connection with the Thermo-Hygro sensor, the outdoor readings will show dashes.

- Simply hold the +/SEARCH button for 3 seconds to search for the sensor.
- The sensor reception icon will flash while searching. 

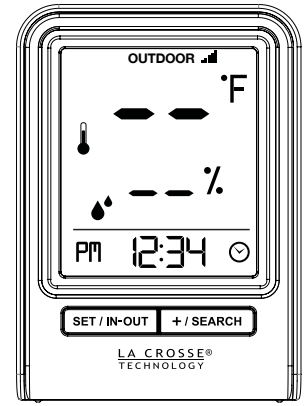

### Restart:

1. Remove batteries for 15 minutes.
2. Press any button 20 times.
3. Install fresh batteries.
4. Allow up to 3 minutes to receive your Thermo-hygro sensor

## HELP US, HELP YOU

If you require additional support, call our friendly customer support team based out of La Crosse, Wisconsin.

**Phone:** 1.844.200.8752

Or fill out our online support request form here:

[bit.ly/contact\\_techsupport](http://bit.ly/contact_techsupport)

Our knowledgeable customer support team is available:  
Monday-Friday, 8am-6pm CST.

## JOIN THE CONVERSATION

Ask questions, watch detailed setup videos, and provide feedback on our social media outlets!



# SPECIFICATIONS

## Indoor

<b>C83100 Temperature Range:</b>	32°F to 99°F (0°C to 37°C)
<b>LTV-D1 Temperature Range:</b>	32°F to 122°F (0°C to 50°C)
<b>Both Stations Humidity Range:</b>	10% RH to 99%RH
<b>C83100 Relative Pressure:</b>	23.62 to 32.48 InHg (800 to 1100 hPa) Pressure is measured every 12 minutes

## Thermo-hygro Sensor

<b>Temperature Range:</b>	-40°F to 140°F (-40°C to 60°C) <b>Note:</b> Temperatures below -20°F (-29°C) require Lithium batteries in the outdoor sensor.
<b>Humidity Range:</b>	10% RH to 99%RH
<b>Transmission Range:</b>	Up to 400 feet (121 meters) in open air, RF 915 MHz

## Wind Speed Sensor

<b>Wind Speed Range:</b>	0-111 mph (0-178 kmh)
<b>Transmission Range:</b>	Up to 400 feet (121 meters) in open air, RF 915 MHz

## Rain Sensor

<b>Rainfall Range:</b>	0-393.6 inches ( 0-9999 mm)
<b>Transmission Range:</b>	Up to 400 feet (121 meters) in open air, RF 915 MHz

## Wi-Fi

<b>Transmission:</b>	RF 2.4 GHz
----------------------	------------

## Power

<b>C83100 Station:</b>	5.0 Volt power cord included (Required) AC6: XH0500-600W (Input 100-240V)
<b>Battery Backup:</b>	CR2032 battery included, backup for time and date
<b>LTV-TH2 Thermo-hygro Sensor:</b>	2-AA batteries included
<b>LTV-W1 Wind Speed Sensor:</b>	2-C batteries included
<b>LTV-R2 Rain Sensor:</b>	2-AA batteries included
<b>LTV-D1 Bonus Station:</b>	2-AAA batteries included

## Battery Life

<b>C83100 Station:</b>	over 24 months with power cord use
<b>LTV-TH2, LTV-W1, &amp; LTV-R2 Sensors:</b>	over 24 months with reputable batteries.
<b>LTV-D1 Bonus Station:</b>	over 12 months with reputable batteries.

## Dimensions

<b>C83100 Station:</b>	8.22" W x 1.18" D x 5.83" H (22.88cm W x 3.0 cm D x 14.81cm H)
<b>LTV-TH2 Thermo-hygro Sensor:</b>	1.97" W x 0.75" D x 5.73" H (5.0cm L x 1.91cm W x 14.55cm H)
<b>LTV-W1 Wind Speed Sensor:</b>	7.10" W x 7.10" D x 18.57" H (18.03cm L x 18.03cm W x 47.17cm H) with mounting bracket/pole
<b>LTV-R2 Rain Sensor:</b>	7.14" W x 3.43" D x 4.94" H (18.13cm L x 8.72cm W x 12.54cm H)
<b>LTV-D1 Bonus Station:</b>	2.64" W x 1.32" D x 3.62" H ( 6.7 cm L x 3.35cm W x 9.19cm H)

## Sensor Update Intervals

<b>LTV-TH2 Thermo-hygro Sensor:</b>	Change of Temp +/- 0.5°C (0.9°F), Hum +/- 2% RH or 3 minutes if no change Checks Temp/Humidity every 51 seconds
<b>LTV-W1 Wind Speed Sensor:</b>	Change of 0.8km (0.5mph) Wind Speed or 3 minutes if no change Checks for change in Wind Speed every 31 seconds, samples every 3 seconds
<b>LTV-R2 Rain Sensor:</b>	Change of 0.2mm (0.008 in) Rainfall - 3 minutes if no change Checks Rain every 45 seconds

## CARE & MAINTENANCE

- Do not mix old and new batteries.
- Do not mix Alkaline, Standard, Lithium, or Rechargeable Batteries.
- Always purchase the correct size and grade of battery most suitable for intended use.
- Replace all batteries of a set at the same time.
- Clean the battery contacts and also those of the device prior to battery installation.
- Ensure the batteries are installed with correct polarity (+ and -).
- Remove batteries from equipment when it is not used for an extended period of time.
- Promptly remove expired batteries.

## WARRANTY & SUPPORT

La Crosse Technology, Ltd. provides a 1-year limited time warranty (from date of purchase) on this product relating to manufacturing defects in materials & workmanship.

Before returning a product, please contact our friendly customer support with questions or visit our online help:

Phone: 1-844-200-8752

Online Product Support and Registration: [bit.ly/contact\\_techsupport](http://bit.ly/contact_techsupport)

**⚠ WARNING:** This product can expose you to chemicals including styrene, which is known in the State of California to cause cancer. For more information go to: [www.P65Warnings.ca.gov/](http://www.P65Warnings.ca.gov/)

## FCC STATEMENT

This equipment has been tested and found to comply with the limits for a Class B digital device, pursuant to part 15 of the FCC Rules. These limits are designed to provide reasonable protection against harmful interference in a residential installation. This equipment generates, uses and can radiate radio frequency energy and, if not installed and used in accordance with the instructions, may cause harmful interference to radio communications. However, there is no guarantee that interference will not occur in a particular installation.

If this equipment does cause harmful interference to radio or television reception, which can be determined by turning the equipment off and on, the user is encouraged to try to correct the interference by one or more of the following measures:

- Reorient or relocate the receiving antenna.
- Increase the separation between the equipment and receiver.
- Connect the equipment into an outlet on a circuit different from that to which the receiver is connected.
- Consult the dealer or an experienced radio/TV technician for help.

This device must not be co-located or operating in conjunction with any other antenna or transmitter.

### **Operation is subject to the following two conditions:**

- (1) This device may not cause harmful interference, and
- (2) This device must accept any interference received, including interference that may cause undesired operation.

### **Caution!**

The manufacturer is not responsible for any radio or TV interference caused by unauthorized changes or modifications to this equipment. Such changes or modifications could void the user authority to operate the equipment.

This equipment must be installed and operated in accordance with provided instructions and the antenna(s) used for this transmitter must be installed to provide a separation distance of at least 20 cm from all persons and must not be co-located or operating in conjunction with any other antenna or transmitter

All rights reserved. This manual may not be reproduced in any form, even in part, or duplicated or processed using electronic, mechanical or chemical process without the written permission of the publisher. This booklet may contain errors or misprints.

The information it contains is regularly checked and corrections are included in subsequent editions. We disclaim any responsibility for any technical error or printing error, or their consequences.

All trademarks and patents are recognized.

## CANADA STATEMENT

This device complies with Industry Canada's licence-exempt RSSs. Operation is subject to the following two conditions:

- (1) This device may not cause interference; and
- (2) This device must accept any interference, including interference that may cause undesired operation of the device.

Le présent appareil est conforme aux CNR d'Industrie Canada applicables aux appareils radio exempts de licence. L'exploitation est autorisée aux deux conditions suivantes :

- (1) l'appareil ne doit pas produire de brouillage;
- (2) l'utilisateur de l'appareil doit accepter tout brouillage radioélectrique subi, même si le brouillage est susceptible d'en compromettre le fonctionnement.

*Apple and the Apple logo are trademarks of Apple Inc., registered in the U.S. and other countries.*

*App Store is a service mark of Apple Inc.*

*Google Play and the Google Play logo are trademarks of Google Inc.*

Made in China - Printed in China